

INVESTIGATION OF GROUND VIBRATIONS INDUCED BY PRODUCTION  
BLASTING AT UŞAK KIŞLADAĞ GOLD MINE

A THESIS SUBMITTED TO  
THE GRADUATE SCHOOL OF APPLIED AND NATURAL SCIENCES  
OF  
MIDDLE EAST TECHNICAL UNIVERSITY

BY

BEZMİ BARIŞ ÇAKMAK

IN PARTIAL FULFILLMENT OF THE REQUIREMENTS  
FOR  
THE DEGREE OF MASTER OF SCIENCE  
IN  
MINING ENGINEERING

SEPTEMBER 2007

Approval of the thesis:

**INVESTIGATION OF GROUND VIBRATIONS INDUCED BY  
PRODUCTION BLASTING AT UŞAK KIŞLADAĞ GOLD MINE**

submitted by **BEZMİ BARIŞ ÇAKMAK** in partial fulfillment of the requirements  
for the degree of **Master of Science in Mining Engineering Department, Middle  
East Technical University** by,

Prof. Dr. Canan Özgen \_\_\_\_\_  
Dean, Graduate School of **Natural and Applied Sciences**

Prof. Dr. Celal Karpuz \_\_\_\_\_  
Head of Department, **Mining Engineering**

Assoc. Prof. Dr. H. Aydın Bilgin \_\_\_\_\_  
Supervisor, **Mining Engineering Dept., METU**

**Examining Committee Members:**

Prof. Dr. Tevfik GÜYAGÜLER \_\_\_\_\_  
Mining Engineering Dept., METU

Assoc . Prof. Dr. H. Aydın BİLGİN \_\_\_\_\_  
Mining Engineering Dept., METU

Assist. Prof. Dr. Mehmet Ali HİNDİSTAN \_\_\_\_\_  
Mining Engineering Dept., Hacettepe University

Prof. Dr. Celal KARPUZ \_\_\_\_\_  
Mining Engineering Dept., METU

Assoc . Prof. Dr. Levent TUTLUOĞLU \_\_\_\_\_  
Mining Engineering Dept., METU

**Date:**

**I hereby declare that all information in this document has been obtained and presented in accordance with academic rules and ethical conduct. I also declare that, as required by these rules and conduct, I have fully cited and referenced all material and results that are not original to this work.**

Name, Last name:      Bezmi Barış Çakmak

Signature :

## ABSTRACT

### INVESTIGATION OF GROUND VIBRATIONS INDUCED BY PRODUCTION BLASTING AT UŞAK KIŞLADAĞ GOLD MINE

Çakmak, Bezmi Barış

M.Sc., Department of Mining Engineering

Supervisor: Assoc. Prof. Dr. H. Aydın Bilgin

September 2007, 194 pages

Ground vibrations from blasting are acoustic waves that propagate through the earth. They are also termed seismic waves because their propagation characteristics are similar to the ground motions produced by earthquakes. Amplitude of ground vibration induced by blasting may vary significantly at or around an open pit mine depending on parameters such as the maximum amount of explosive detonating at a time interval and the physical distance between the shot and the location of concern, whereas the frequency of vibration mainly vary depending on the geology and blast delay intervals. Therefore evaluation and assessment of ground vibration condition at or around an open pit mine is necessary.

The objective of the proposed research study is to monitor and record the ground vibration and to investigate and assess the vibration conditions at neighbouring districts that are induced by production blasting operations at Usak Kışladağ Gold Mine. In this research study, several parameters such as the ground vibration velocity, the amount of charge per delay, the physical distance to the location of monitoring device or residential structures are recorded, analyzed and evaluated



together with the frequencies of the seismic waves. The determined ground vibration velocities are compared with the allowable limits given in Turkish Regulation and US Federal Regulation. Thus, the compliance of the ground vibrations with the above mentioned regulations are discussed and assessed. Furthermore, the parameters which affect the ground vibration are discussed and determined.

In this study, the monitored and the recorded ground vibrations are evaluated from structural damage potential and human disturbance points of views. It is determined that the ground vibration levels recorded during this study and analyzed from the past records comply with Turkish and US Federal regulations. It is concluded that no damage has been occurred in structures at surrounding settlements and the occupants were not disturbed by the direct effect of vibrations in the past and at present. The analysis proved that the blasting operations to be conducted in the future will not create any damage and disturbance provided that the charge detonated per delay is kept less than 155 kg's.

Keywords: Ground vibration, seismic wave, frequency, particle velocity, round blast.

## ÖZ

### UŞAK KIŞLADAĞ ALTIN MADENİNDE ÜRETİM PATLATMASINDAN KAYNAKLANAN YER TİTREŞİMLERİNİN ANALİZİ

Çakmak, Bezmi Barış

Y. Lisans, Maden Mühendisliği Bölümü

Tez Danışmanı: Doç. Dr. H. Aydın BİLGİN

Eylül 2007, 194 sayfa

Patlatmadan kaynaklanan yer titreşimleri yeryüzünde ilerleyen akustik dalgalardır. Yer titreşimleri ilerleyiş yapısı olarak deprem kaynaklı yer hareketlerine benzemesinden dolayı sismik dalgalar olarak ta adlandırılır. Bir açık işletmede veya çevresinde patlatmadan kaynaklanan titreşim büyüklüğü bir zaman aralığında patlayan maksimum patlayıcı miktarı ve patlatma yeri ile ölçüm yeri arasındaki fiziksel mesafeden etkilenerek değişirken, titreşim frekansı ise jeoloji ve gecikme zaman aralığına bağlı olarak değişir. Bu sebeple herhangi bir açık işletmede veya çevresinde yer titreşimi durumunun değerlendirilmesi ve belirlenmesi gereklidir.

Önerilen tez konusu Uşak Kışladağ Altın madeninde üretim patlatması uygulamasından kaynaklanan yer titreşiminin ölçülmesi, kaydedilmesi ve komşu yerleşim alanlarındaki yer titreşimi durumunun incelenmesi ve değerlendirilmesidir. Bu araştırmada titreşim hızı, gecikme başına patlayıcı miktarı, ölçüm istasyonlarına veya yerleşim alanlarına olan uzaklık gibi parametreler sismik dalgaların frekansı ile birlikte kaydedilecek, incelenecek ve değerlendirilecektir. Belirlenen yer titreşimi hızları Türk Yönetmeliği'nde ve ABD Federal Tüzüğü'nde izin verilen

sınır deęerler ile karşılaştırılacaktır. Yer titreşimlerinin belirtilen yönetmelikler ile yapılan karşılaştırması incelenip yorumlanacaktır. Ayrıca yer titreşimini etkileyen faktörler incelenip belirlenecektir.

Araştırma döneminde ölçölüp kaydedilen yer titreşimleri yapılarda hasar ve insanlarda rahatsızlık yaratma olasılığı yönlerinden deęerlendirilmiştir. Gerek bu çalışma sırasında kaydedilen ve gerekse önceden alınmış yer titreşimi kayıtlarının incelenmesi sonucunda, yer titreşimi deęerlerinin Türk Yönetmeliğine ve ABD Federal Tüzüğüne uygun olduğu belirlenmiştir. Çevre yerleşim birimlerindeki binalarda geçmişte ve günümüzde herhangi bir yapısal hasar meydana gelmediği ve kişilerin titreşimlerden rahatsız olmadıkları sonuç ve kanaatına varılmıştır. Yapılan analizler göstermiştir ki gecikme başına ateşlenen patlayıcı miktarının 155 kg'dan az olması koşuluyla ileride yapılacak olan patlatma uygulamaları da herhangi bir hasar veya rahatsızlık yaratmayacaktır.

Anahtar Kelimeler: Yer titreşimi, sismik dalga, frekans, parçacık hızı, grup patlatması.

## ACKNOWLEDGEMENTS

I highly express my sincere appreciation to Assoc. Prof. Dr. H. Aydın BİLGİN for his kind supervision.

I offer my thanks to the examining committee members for serving on the M.S. thesis committee.

I also thank to the other department staff for their suggestions and guidance throughout both the lecture and thesis period.

Recep Kaya, Ebru Demir, Onur Bigikoçin and Esenay Hacıosmanoğlu are gratefully acknowledged for their help during the various stages of the fieldwork and preparation of the thesis.

I also offer sincere thanks to personnel of TÜPRAG Metal Madencilik Sanayi ve Ticaret Ltd. Sti. Kışladağ Gold Mine.

To my family, I would like to express my great pleasure for their support.

## TABLE OF CONTENTS

ABSTRACT .....	iv
ÖZ.....	vi
ACKNOWLEDGEMENTS .....	viii
TABLE OF CONTENTS .....	ix
LIST OF TABLES.....	xii
LIST OF FIGURES .....	xiv
LIST OF ABBREVIATIONS .....	xviii

### CHAPTER

1. INTRODUCTION .....	1
1.1. Research Objectives .....	3
2. LITERATURE REVIEW .....	6
2.1. Introduction.....	6
2.2. General Ground Vibration Characteristics .....	8
2.2.1. Principal of Ground Vibrations .....	8
2.2.2. Vibration Terminology .....	9
2.2.3. Types of Vibration Waves .....	10
2.2.3.1. Body waves .....	10
2.2.3.2. Surface Waves .....	12
2.2.4. Propagation Velocity .....	14
2.3. Peak Component and True Vector Sum .....	15
2.4. Frequency Properties and Durations .....	16
2.5. Methods of Measuring Frequencies .....	17
2.6. Impact of Natural and Technological Factors on Seismic Effects of a Blast .....	18
2.6.1. Blasting conditions .....	18
2.6.2. Construction of explosive charge .....	19
2.6.3. Conditions of placing charges .....	19
2.6.4. Properties of rocks .....	20
2.6.5. Short delay blasting (SDB) .....	21
2.7. Structure Response to Blast Excitation .....	23
2.7.1. Structure Components and Ground Vibration Parameters.....	26
2.7.2. Resonation and Amplification Factor .....	27
2.7.3. Distinction of Blast-Induced Cracking from Natural Cracking .....	28
2.7.4. Safe Levels of Blasting Vibrations for Residential Type Structures.....	29
2.8. Human Response to Blast Induced Ground Vibrations.....	33
2.9. Determination of Scaled Distance versus Peak Particle Velocity Relation.....	37
2.10. Previous Investigations for Damage Criteria.....	39
2.10.1. Vibration Energy as Damage Criteria.....	39
2.10.2. Peak Particle Velocity as Damage Criteria.....	40
2.10.3. Peak Particle Velocity and Frequency as Damage Criteria .....	41

2.10.4. Peak Particle Velocity and Scaled Distance as Damage Criteria.....	43
3. STUDY AREA AND GEOLOGY .....	45
3.1. Mine Site.....	45
3.2. Geology.....	49
3.2.1. Introduction.....	49
3.2.2. Lithologic Units.....	50
3.2.2.1. Outcrop Lithology Codes.....	51
3.2.2.2. Basement Metamorphic Rocks (pCM) .....	51
3.2.2.3. Beydagi Volcanic Sequence.....	51
3.2.2.3.1. Latite Flows (PBf).....	52
3.2.2.3.2. Quartz Latite Flows (PBq).....	52
3.2.2.3.3. Monolithologic Breccia (PBb).....	53
3.2.2.3.4. Stratified Tuffaceous and Epiclastic Rocks (PBvc).....	53
3.2.2.3.5. Volcanic Conglomerate (PBcg).....	53
3.2.2.3.6. Intrusive Rocks (PBi).....	54
3.3. Structural Geology .....	54
3.3.1. Pre-volcanic Deformation.....	54
3.3.2. Syn- and Post- Volcanic Deformation.....	55
3.4. Rock Mass Property Description.....	55
4. BLASTING METHOD AND MONITORING PROCEDURE.....	61
4.1. Introduction.....	61
4.2. Methods of Mining and Blasting Practiced .....	63
4.2.1. Production Blasting Parameters .....	64
4.3. Structural Features of the Buildings.....	67
4.4. Monitoring Procedure.....	76
4.4.1. White Mini-Seis II model seismograph.....	77
4.4.2. InstanTel® Minimate® model seismograph.....	79
5. RESULTS AND DISCUSSIONS.....	81
5.1. Monitoring Paths.....	81
5.1.1. Gümüşkol Village Path.....	81
5.1.2. Katrancılar District Path .....	83
5.1.3. Karapınar District Path .....	85
5.2. Records Taken Along Gümüşkol Village Path.....	87
5.2.1. Evaluation of Vibration Velocities Recorded Along Gümüşkol Village Path .....	88
5.2.2. Dominant Frequencies of Seismic Waves .....	91
5.3. Records Taken Along Karapınar District Path .....	93
5.3.1. Evaluation of Vibration Velocities Recorded Along Karapınar District Path .....	96
5.3.2. Dominant Frequencies of Seismic Waves .....	98
5.4. Records Taken Along Katrancılar District Path.....	100
5.4.1. Evaluation of Vibration Velocities Recorded Along Katrancılar District Path.....	101
5.4.2. Dominant Frequencies of Seismic Waves .....	104
5.5. Evaluation of Previous Vibration Records .....	106
5.5.1. Allowable Vibration Velocity.....	109

5.5.2. Allowable Vibration Limit from Dominant Frequency Point of View	110
5.5.3. Summary on Ground Vibration Evaluation .....	111
6. CONCLUSIONS AND RECOMENDATION.....	113
REFERENCES .....	115
APPENDICES	
A. SCALED DISTANCE – PARTICLE VELOCITY RELATIONS DETERMINED FOR GÜMÜŞKOL VILLAGE PATH.....	122
B. SCALED DISTANCE – PARTICLE VELOCITY RELATIONS DETERMINED FOR KARAPINAR DISTRICT PATH .....	145
C. SCALED DISTANCE – PARTICLE VELOCITY RELATIONS DETERMINED FOR KATRANCILAR DISTRICT PATH .....	150
D. VIBRATION RECORDS TAKEN ALONG GÜMÜŞKOL VILLAGE PATH .....	166
E. VIBRATION RECORDS TAKEN ALONG KARAPINAR DISTRICT PATH .....	171
F. VIBRATION RECORDS TAKEN ALONG KATRANCILAR DISTRICT PATH .....	188
G. DIP DIRECTIONS AND DIP AMOUNTS OF DISCONTINUITIES.....	193

## LIST OF TABLES

Table 2.1 Safe levels of blasting vibrations (Siskind et. al., 1980, USBM). .....	29
Table 2.2 Maximum allowable peak particle velocity for blasting vibrations (OSM, 1983, 30 CFR, Parts 715, 780, 816, 817).....	30
Table 2.3 Allowable peak vibration levels as a function of seismic wave frequency (USBM RI 8507) .....	32
Table 2.4 Allowable peak component velocities in DIN 4150 Standard.....	33
Table 2.5 Tolerable limits for vibration velocity (whole-body vibration for one-minute durations).....	36
Table 2.6 Peak vibration amplitudes tolerated by humans in buildings .....	36
Table 2.7 Langefors and Kihlstrom’s Criterion .....	41
Table 2.8 Guideline value of vibration velocity, DIN 4150, 1993 (Nick, 2002) .....	42
Table 5.1 Ground vibrations recorded along Gümüşkol Village path.....	89
Table 5.2 Maximum allowable charge amount per delay calculated for different distances and limiting PPV values for Gümüşkol Village path .....	900
Table 5.3 Distances at which PPV falls to the selected different limiting PPV values for various charge amounts per delay for Gümüşkol Village path.....	92
Table 5.4 Ground vibrations recorded along Karapınar District path .....	955
Table 5.5 Maximum allowable charge amount per delay calculated for different distances and limiting PPV values for Karapınar District path.....	977



Table 5.6 Distances at which PPV falls to the selected different limiting PPV values for various charge amounts per delay for Karapınar District path .....	99
Table 5.7 Ground vibrations recorded along Katrancılar District path .....	1022
Table 5.8 Maximum allowable charge amount per delay calculated for different distances and limiting PPV values for Katrancılar District path.....	1033
Table 5.9 Distances at which PPV falls to the selected different limiting PPV values for various charge amounts per delay for Katrancılar District path .....	1066
Table 5.10 Vibration recorded at the ground next to buildings during previous blasts. ....	1088
Table 5.11 Comparison of the calculated and the measured vibration velocities ....	112

## LIST OF FIGURES

Figure 2.1 Sequence of events occurring in the rock mass after detonation (Dowding and Aimone 1992).....	7
Figure 2.2 Typical blast vibration time history (Dowding 1985).....	9
Figure 2.3 Characteristic of P-Wave in a solid medium (Atlas, 1987).....	11
Figure 2.4 Characteristic of S-Wave in a solid medium (Atlas, 1987).....	11
Figure 2.5 Characteristic movement of Rayleigh wave in a solid medium (Atlas, 1987) .....	12
Figure 2.6 Characteristic of Love waves in a solid medium (Atlas, 1987).....	13
Figure 2.7 Three components of the ground vibration (Dowding 1985).....	14
Figure 2.8 Safe level blasting vibration criteria for houses from USBM RI 8507 and the derivative version, the chart option from OSM Regulation (Siskind, 2000).....	31
Figure 2.9 Human response to vibrations of various durations, summary. ISO values are from Standard 2631 (Siskind et. al., 1980).....	34
Figure 2.10 Human response to transient vibration velocities of various durations and frequencies (Siskind et. al., 1980).....	35
Figure 2.11 Curves Representing the Vibration Velocity as A Function of the .....	43
Figure 3.1 Location of the Mining site .....	46
Figure 3.2 General view of Uşak Kışladağ Open Pit Gold Mine from the mining site.....	47

Figure 3.3 Final pit boundary of the Uşak Kışladağ Open Pit Gold Mine, the Gümüşkol Village, Karapınar and Katrancılar districts and the monitoring stations.	48
Figure 3.4 The rock masses exposed within the pit.....	56
Figure 3.5 The rock masses exposed at the road cuts along Gümüşkol Village path	56
Figure 3.6 The dip direction and dip amounts of 106 discontinuities that are measured in the pit and analyzed by the software ‘Rockscience Dips Version 5’ .....	58
Figure 3.7 The dip direction and dip amounts of 83 discontinuities that are measured at the roadcuts along Gümüşkol path and analyzed by the software ‘Rockscience Dips Version 5’ .....	59
Figure 4.1 Uşak Kışladağ Open Pit Mine final boundary, neighboring settlements and monitoring paths.....	62
Figure 4.2 Charging pattern used to form a new bench at a natural slope.....	64
Figure 4.3 Explosive charging patterns for short and long blast holes.....	65
Figure 4.4 Initiation pattern using 25 ms in row and 42 ms inter row delay periods.	66
Figure 4.5 Initiation pattern using 42 ms in row and 67 ms inter row delay period...	67
Figure 4.6 Clay mortared rubble stone building at Gümüşkol Village.....	70
Figure 4.7 Structure built with undressed stone and dressed stones at corners using clay mortar in 1945 at Katrancılar District.....	70
Figure 4.8 Clay mortared hybrid (undressed and dressed stones and solid bricks) structure at Gümüşkol Village.....	71

Figure 4.9 Close in view of clay mortar at the bare wall of rubble stone building at Gümüşkol Village .....	71
Figure 4.10 The repaired tension cracks at the corner of the building formed previously due to differential ground settlement or weak foundation at Gümüşkol Village .....	72
Figure 4.11 Different structure types at Gümüşkol Village; rubble stone building with clay mortar at right, lime mortared solid/cellular brick walled and reinforced but not engineered structures at the middle and left .....	72
Figure 4.12 Hybrid structure at Gümüşkol Village (rubble stone foundation and cellular brick wall are laid using clay mortar, lintel above window and roof slab are reinforced concrete) .....	73
Figure 4.13 Two story hybrid structure at Micanlar District (rubble stone wall at ground floor and cellular brick wall at first floor are laid using clay mortar, lintels above windows are reinforced concrete).....	73
Figure 4.14 House at Micanlar District (Normal vertical tension crack at exterior wall and normal vertical shear crack at the intersection of exterior and interior walls, note hatchures across the crack) .....	74
Figure 4.15 House at Micanlar District (deflection of wood beam, resting on interior door lintel instead of a column, contributed to the development of shear crack at the wall intersection in Figure 4.14).....	74
Figure 4.16 Crack patterns explaining the mechanism of formation of cracks observed at the first floor of house and given in Figure 4.14 (normal vertical tension crack at right, normal vertical shear crack at left, Audell, 1996) .....	75
Figure 4.17 White Mini-Seis II model seismograph, GPS (Global Positioning System) instrument. ....	76

Figure 4.18 InstanTEL® Minimate® model seismograph.....	77
Figure 4.19 Waveforms of a round-blast event from data analysis software called “White Seismograph Data Analysis 2003”.....	78
Figure 4.20 Waveforms of a round-blast event from data analysis software called “InstanTEL Blastware® Compliance Module software”.....	80
Figure 5.1 Monitoring stations along Gümüşkol Village path.....	82
Figure 5.2 Monitoring stations along Katrancılar District path .....	84
Figure 5.3 Monitoring stations along Karapınar District path .....	86

## LIST OF ABBREVIATIONS

<b>A</b>	:	Amplitude of displacement
<b>t</b>	:	Period
<b>f</b>	:	Frequency
<b>v</b>	:	Velocity
<b>R</b>	:	Radial component of vibration
<b>V</b>	:	Vertical component of vibration
<b>T</b>	:	Transverse component of vibration
<b>PV</b>	:	Particle velocity
<b>PPV</b>	:	Peak particle velocity
<b>a</b>	:	Acceleration
<b>s</b>	:	Distance of any particle from its rest position
<b>D</b>	:	Absolute distance
<b>Q</b>	:	Co-operating charge (charge per delay)
<b>SD</b>	:	Scaled distance
<b>Fd</b>	:	Fundamental natural frequency
<b>k</b>	:	Ground transmission coefficient
<b>m</b>	:	Specific geological constant
<b>VOD</b>	:	Velocity of detonation
<b>VS</b>	:	Vector Sum of three vibration components
<b>USBM</b>	:	United States Bureau of Mines
<b>OSMRE</b>	:	Office of Surface Mining Reclamation and Enforcement
<b>FFT</b>	:	Fast Fourier Transform
<b>R</b>	:	Correlation Coefficient
<b>R<sup>2</sup></b>	:	Coefficient of Determination

## CHAPTER 1

### INTRODUCTION

Rock excavation is important for mining minerals and quarrying that played a great role in civilization. Rock excavation is done either by mechanical means or blasting. When blasting is concerned, some energy is to be spent to break and move the rock. This energy is provided by explosives but not all of the energy is transmitted to the rock. Some of the energy applied to the rock by the detonating blast is inevitably converted into non-productive “waste” energy in the form of ground vibration. This energy leaves the vicinity of the blast and can travel a significant distance (as much as thousands of meters) before finally dissipating to negligible levels. Transfer of energy is a function of both the characteristics of the explosive and that of the rock. Berta (1990) explains that only about 20% of total energy exposed by the explosive is consumed usefully in productive efforts such as rock fracturing, rock breakage and rock displacement.

Some of the effects produced by a blast can be regarded as useful work, whereas the remaining consequential effects can be classified as non-productive, undesirable and inevitable.

Productive effects are:

1. Fracture of rock in situ;
2. Breakage of certain volume of rock into well defined regular sized elements;
3. Displacement of broken rock to a certain distance from the original position.

Non-productive effects are:

1. Excessive breakage of part of the blasted rock and dust formation;
2. Over-breakage (permanent deformations in the rock behind the shot);

3. Fly-rock (excessive throw of rock);
4. Air-blast and noise;
5. Ground vibrations.

As a result of the analysis for the total energy balance, Berta (1990), from his research deduced that the energy transmitted to the rock is roughly, distributed as follows:

- fracture in situ < 1%
- breakage 15%
- displacement 4%
- excessive crushing in the vicinity of the hole 1.5-2%
- flyrock < 1%
- deformation of the solid rock behind shot <1%
- ground vibrations 40%
- airblast 38-39%

From the distribution of energy transmitted to the rock it can be concluded that a greater percentage of the energy is spent in terms of the non-productive effects such as ground vibration and airblast. Therefore a great care should be spent on the planning and execution of blasting work. Otherwise great percentage of energy responsible for ground vibration and airblast may create damages to rock structures and buildings, and disturbance to human occupants.

An integral part of the process of rock blasting is ground vibrations that are consequently unavoidable. Vibration problems and complaints have also increased with the general trend toward large blasts in mining and construction projects. Consequently, lawsuit cases have developed between the mining industry and the general public at an accelerating rate. Complaints ranges from human disturbance to outright demolition of a residential structure, and although some of these claims are exaggerated, other legitimate. In spite of the many varying damage criteria established in the past, it is difficult to completely isolate vibration damage from



damage caused by natural setting of the building, inadequate construction, old ages, etc. Even if a valid “fool proof” damage criterion were established, the critical problem remains to eliminate or considerably reduce all complaints resulting from ground vibrations, regardless of what the prevailing legal vibration limits are within a community. Therefore, the effect of ground vibrations produced by blasting on building structures and human beings need to be predicted, monitored, and controlled by the blasting engineer as part of optimizing the job.

To characterize ground vibration induced by blasting many studies have been conducted. The particle velocity magnitudes and frequency are the well-known ground vibration characteristics. Dowding, (1985); Konya and Walter, (1991); and before that Siskind et. al., (1980), demonstrated that magnitude of ground vibration is directly proportional to amount of charge per delay and inversely proportional to traveling distance. As a result of that, the concept of scaled distance was put forward in order to calculate the attenuation of particle velocity in the ground. Therefore, using the attenuation equation, derived from the relationship between the scaled distance and vibration magnitude, it is possible to predict the peak particle velocity as well as to find out the maximum allowable charge weight per delay for the blasting site. Estimation of the peak particle velocity and other components of ground vibration with reliable approach provide important facilities to the miners. Although many studies were carried out to isolate site specific problems from prediction of the peak particle velocity and the other components of vibration a generally applicable theoretical formula has not been established yet. So a site specific study is still needed to minimize the ground vibration impacts.

### **1.1. Research Objectives**

The subject of the research was to assess the environmental impacts induced by the blasts conducted at Kışladağ Gold Mine. The subject also includes ground vibration monitoring and recording using the devices belonging both to the University and the

Mine, and determination of the situation at present and the past together with possible risks (if any) and reporting of the results.

To reach this objective the following steps are followed:

- a- Uşak Kışladağ Open Pit Mine was visited, blasting sites and ground conditions were investigated, the final pit boundary and the distances to nearby settlements were determined, and the blasting parameters such as diameters and depths of holes, charge quantities, drilling and firing patterns were observed and recorded.
- b- The structure types at surrounding settlements were determined, their technical conditions were investigated, some photographs were taken and finally the levels of ground vibration that they can safely tolerate were determined.
- c- Ground vibration monitoring and recording were carried out using the devices belonging to both University and Mine during the blasting operations.
- d- The previous monitoring records taken by the Kışladağ Gold Mine Management were analyzed.
- e- The vibration levels recorded previously and during this research were compared with the permitted levels in Turkish and U.S. Regulations, and the environmental impacts of ground vibration were determined. In other words, the potential of structural damage (if any) was evaluated.
- f- The propagation laws for seismic waves in the ground were determined based on the record results.
- g- Tables of distance versus safe explosive amounts per delay were prepared using the propagation law determined for each of the settlements. The calculated safe explosive amounts were compared with those used per delay in the mine at present. So, the risk of structural damage for the future blasts, and possibility of damage occurrence taken place in the past were evaluated.

In the current study, ground vibrations induced by bench blasting from the TÜPRAG Metal Madencilik Sanayi ve Ticaret Ltd. Sti. Kışladağ Gold Mine, were measured to estimate the damage risk and to minimize the ground vibration problem

for Gümüşkol Village, its Micanlar District, and Karapınar and Katrancılar districts that are located around Kışladağ Gold Mine. Literature survey is presented in Chapter 2. The mine site and geology of the area are indicated in Chapter 3. The blasting operation, which is performed as a round-blast, is used to fragment the rock in order to facilitate the removal of overburden and ore. In order to estimate the peak particle velocity and to produce a site-specific propagation equation as well as to estimate the maximum allowable charge for this site, field work and data collection were conducted over a period of two months. A statistical approach is applied to the collected data, and from the data analysis an attenuation relationship is established to be used in predicting the peak particle velocity as well as to calculate the maximum allowable charge per delay. The frequencies are also analyzed to investigate the potential damage to the structures at TÜPRAG Metal Madencilik Sanayi ve Ticaret Ltd. Sti. Kışladağ Gold Mine. The blasting method applied and monitoring procedure are indicated in Chapter 4.

In Chapter 5, the results and discussion are illustrated. Monitoring paths, records taken along these monitoring paths, evaluation of previous vibration record taken are discussed and evaluated in this chapter.

The main conclusions of the research and recommendations for the future studies are given in Chapter 6.

## CHAPTER 2

### LITERATURE REVIEW

#### 2.1. Introduction

It is crucial to understand the basic principles of rock fragmentation by explosive charges for ground vibration assessment and optimizing successful blasting operation. According to Persson (1978), 1-20% of the energy of a detonated explosive charge, and also according to Langefors and Kihlstrom (1967), Duvall (1966) 5-15% of the energy of a detonated explosive charge is transferred to the surrounding rock as shock waves. The remaining part of the explosive energy released as very high pressure and temperature gaseous products of the reaction.

Kutter and Fairhurst (1971) indicated that there are three zones of varying destruction and deformation around the explosion. These zones are;

- the strong shock zone (hydrodynamic zone),
- the non-linear zone, and
- the elastic zone.

In the first zone, the radial compressive stresses generated from the shockwave exceed the dynamic compressive strength of the surrounding rock, and develop complete crushing as rock fail in compression, Figure 2.1 (A). In the second zone, fracturing is due to the tangential stress, Figure 2.1 (B). Since the tensile strength of the rock is not very high, the tangential tensile stresses create fractures. When the strain wave reaches the free surface of the rock, it is reflected and may cause spalling, Figure 2.1 (D).

Since the velocity of longitudinal waves is higher than the velocity of shear waves and as the strength of the rock in tension is much less than in compression, the reflected wave will break the rock in tension if it exceeds the tensile strength.

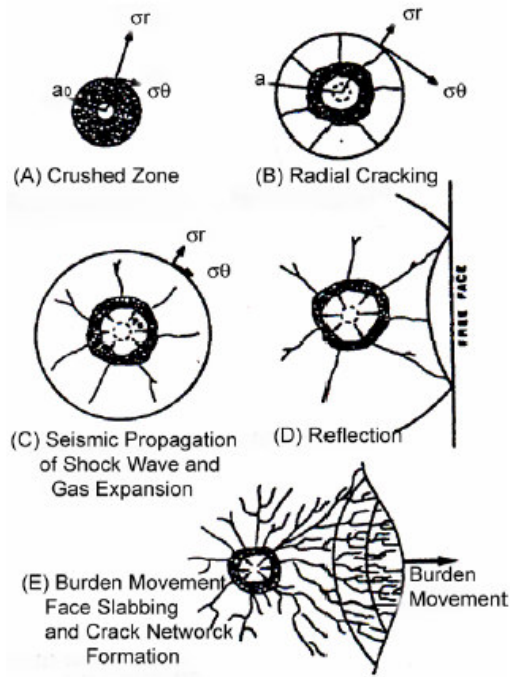

$a_0$  : Borehole radius                       $\sigma_r$  : Radial stress component  
 $a$  : Equilibrium borehole pressure       $\sigma_\theta$  : Tangential stress comp.

Figure 2.1 Sequence of events occurring in the rock mass after detonation (Dowding and Aimone, 1992).

The expanding explosion products start to penetrate into the radial cracks and exert high quasi-static pressure after the passage of the wave. High temperature and high pressure borehole explosive gases can then flow into the system of the radial cracks generated and cause considerable additional extension of the number of these cracks

(Olofsson, 1988). As the burden begins to move high compressive stresses within the rock begins to unload and generate more tensile stresses which complete the fragmentation process. The sequence of the events in the rock mass after the detonation is shown in Figure 2.1.

Generally, the combined effects of shock and gas energies of an explosive causes the rock fracture during blasting and gas energy plays a relatively higher role during rock fragmentation depending upon the energy partitioning characteristics of the explosive. The shock energy remaining after rock fracturing during the blast, in the absence of free faces travels as seismic waves in the ground (Singh, 1999).

## **2.2. General Ground Vibration Characteristics**

### **2.2.1. Principal of Ground Vibrations**

Ground vibration or seismic energy is usually described as the transient movement or a time varying displacement, velocity, or acceleration of a particular point (particle) in the ground due to rock blasting, piling, traffic, excavation, vibrating compaction and so on. Ground vibrations traveling through the ground may damage adjacent structures when they reach a certain magnitude. Some of the energy released from a blast propagates in all directions from the borehole as seismic waves with different frequencies. The energy from these seismic waves is damped by distance and the waves with the highest frequency are damped fastest. This means that the dominant frequencies from the blast are high at short distances and lower at large distances.

In Figure 2.2 a typical particle velocity time history is shown. A vibration wave has plus and minus peak amplitudes, when it propagates. In Figure 2.2 'A' indicates the minus peak amplitude and 'B' indicates the plus peak amplitude. The most important parameters that describe the time history are peak amplitude, principal

period ( $= 1/\text{principal frequency}$ ) and duration of the vibration. All these parameters are dependent on the blast sequence and transmission medium (Dowding, 1985).

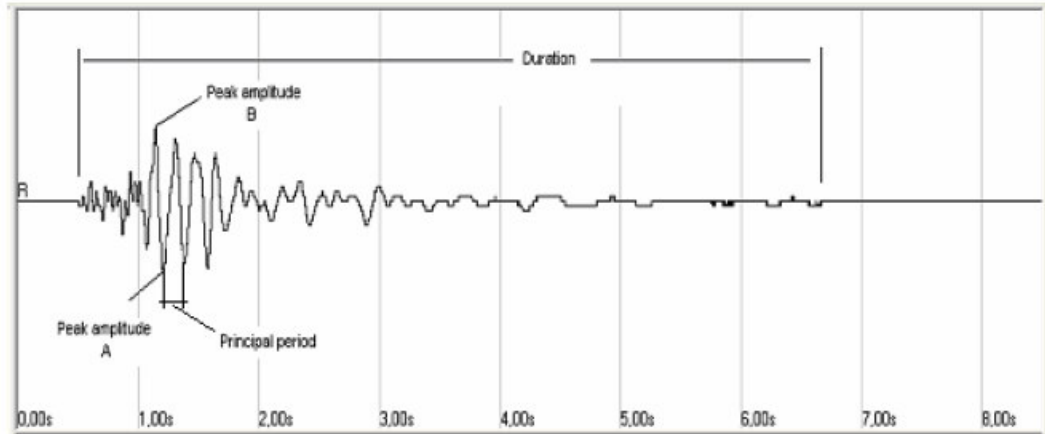

Figure 2.2 Typical blast vibration time history (Dowding, 1985).

### 2.2.2. Vibration Terminology

**Amplitude (A):** A time varying and kinematic vibration quantity of displacement.

**Period (t):** The time required to complete one oscillation.

**Frequency (f):** Number of cycles executed per unit time.

**Cycle:** one complete oscillation of repeated events.

**Velocity (v):** Displacement per unit time.

**Particle Velocity (R,V,T):** The displacement per unit time in reference to the speed or acceleration of the particles in the ground resulting from vibratory motion.

**Peak Particle Velocity (PPV):** The displacement per unit time in reference to a compressional disturbance propagating through any medium.

**Acceleration (a):** The velocity per unit time.

**Displacement (s):** Distance of any particle from its rest position.

**Distance (D):** Total length of travel path taken by an object starting at rest to its final position.

**Co-operating Charge (Q):** Total amount of explosive or blasting agent initiated per delay.

**Scaled Distance (SD):** Scaling factor that incorporates the charge weight influence on the source functions as a generator of vibration or noise.

The size of the ground vibration depends on:

- The amount of co-operating charge
- Distance from the blasting site
- Geology of the site
- Delay period
- Rock type

By selecting the right blast pattern, ground vibrations can be controlled (Arseven, 2003).

### **2.2.3. Types of Vibration Waves**

Interactions between the propagating media and the vibrations give rise to several types of waves. The main wave types can be divided into two: body waves and surface waves (Dowding, 1985).

#### **2.2.3.1. Body waves**

Body waves propagate through the body of the medium (rock or soil) and can be subdivided into P-wave and S-wave;



## P-wave

The P-wave is also called the primary compressional wave. It is the fastest wave through the ground. The particles in the path of wave move in the same direction as the propagation of the wave. The material's density will change when the wave propagates through it. Figure 2.3 shows the characteristics of P-wave in solid medium. The compressional motion is shown by 'C' and the dilational motion is shown by 'D' in Figure 2.3 (Atlas, 1987).

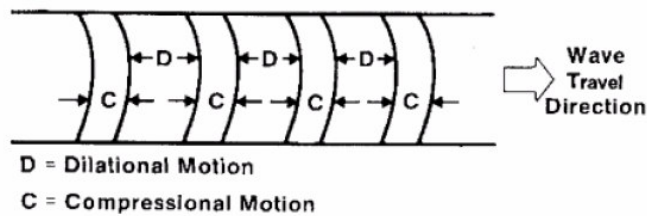

Figure 2.3 Characteristic of P-Wave in a solid medium (Atlas, 1987)

## S-wave

The S-wave is also called the secondary or shear wave. It moves through the medium at the right angle to the wave propagation but slower than the P-wave. The S-wave changes the density of the material when propagating through it. The characteristics of S-wave is shown in Figure 2.4 as it propagates in a solid medium (Atlas 1987).

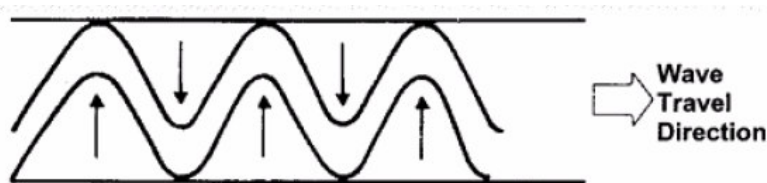

Figure 2.4 Characteristic of S-Wave in a solid medium (Atlas, 1987)

### 2.2.3.2. Surface Waves

Surface waves are transmitted along a surface which is usually the upper ground surface. The most important surface waves generated in rock blast are the Rayleigh wave (R-wave) and Love wave.

#### R-wave

When compared with the P-wave and S-wave the R-wave propagates more slowly and the particles move elliptically in the vertical plane and in the same direction as the propagation. Unlike the body wave's unidirectional particle motions, Rayleigh surface wave particle motion is two dimensional. These waves are similar to those produced by dropping a stone into a pool of water. As the water wave passes a piece of cork, the motion of the cork on water is described by a forward circle. Whereas, in rock a particle will follow a retrograde elliptical path, with the ratio of horizontal to vertical displacements equal to 0.7. Figure 2.5 shows the characteristics of Rayleigh waves propagating in solid medium (Atlas 1987).

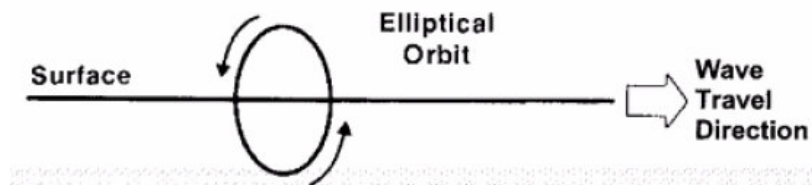

Figure 2.5 Characteristic movement of Rayleigh wave in a solid medium (Atlas, 1987)

## Love wave

The Love wave is a surface wave with horizontal polarized particle motion. It is a transverse wave propagated in a low-velocity surface layer overlying a medium in which elastic waves have higher velocities, as illustrated in Figure 2.6. The Love waves are faster than the Rayleigh waves and give particle motion that is transverse to that of propagation. Since their particle motion is always horizontal, love waves can never be recorded where a vertical geophone is used (Atlas, 1987).

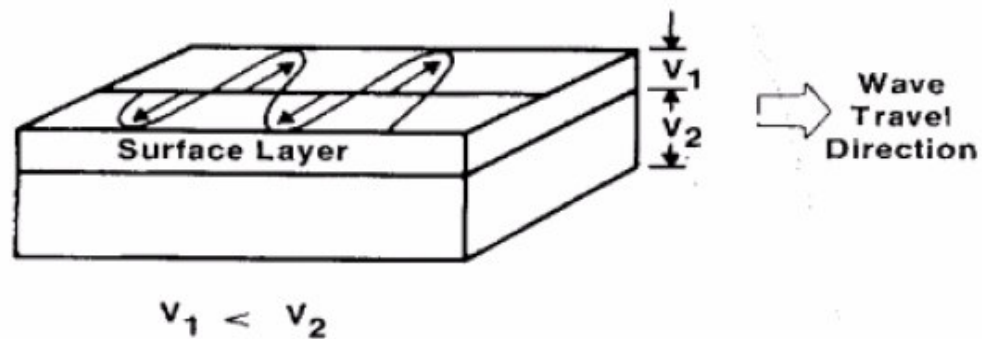

Figure 2.6 Characteristic of Love waves in a solid medium (Atlas, 1987)

The measuring of ground vibrations is usually done in one or several points at ground level. Propagation of blasting vibrations forces the ground to move in an elliptical manner in three dimensions. To describe the motions completely, three perpendicular components of motion must be measured; one is usually oriented along a horizontal radius to the explosion, the other two components will be perpendicular to the radial direction. The directions of the three components of the motion; the longitudinal, L (or radial, R), the vertical, V, and the transverse, T, are shown in Figure 2.7, (Dowding 1985).

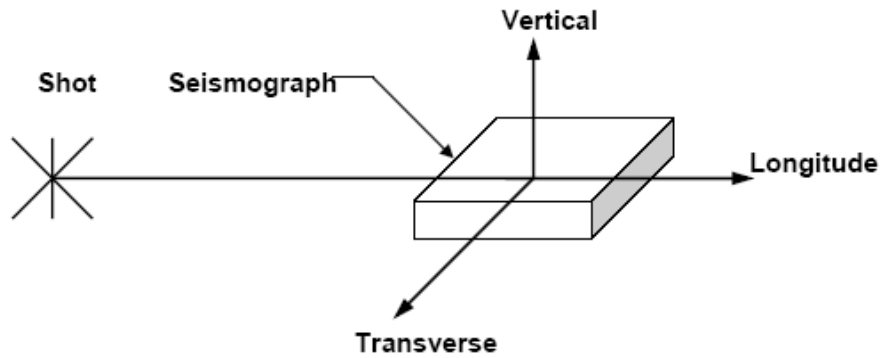

Figure 2.7 Three components of the ground vibration (Dowding 1985)

One of these vibration components, which are normal to each other, always dominates in blasting and the peak component varies with each blasting site. The peak occurs in different times and at different frequencies. The difference between the three components results from the presence of the different wave types in the blast vibration wave trains.

#### 2.2.4. Propagation Velocity

Propagation velocity is the speed of the vibration wave traveling in the rock medium and measured in meters per second. Propagation velocity should not be confused with particle velocity, which is described as the velocity of a particle vibrating in the ground and measured in millimeters per second (Dowding, 1985).

The propagation velocity is an important factor because it is an indirect measure of rock properties that affect decay of peak particle velocities as well as wavelength. Because of the wavelength effect, propagation velocity forms a principle component of Swedish safe blasting practice. The propagation velocities of compressive shear and Rayleigh waves vary. Rock type also controls the propagation velocity (Dowding, 1985).

Propagation velocities are greatly affected by jointing and weathering of rock masses. Jointing changes the rock stiffness which in turn changes the propagation velocity. In general, the intensity of jointing increases and the propagation velocity increases with increasing depth (Dowding, 1985).

### 2.3. Peak Component and True Vector Sum

The variation of motion with each component has led to difficulty in determining which component is the most important. Is it the component with the greatest amplitude, or the peak vector sum of the components? Assume that we have the peak component of 0.9 of velocity unit recorded in longitudinal direction at time 1, and the vertical and the transverse components at the same time are 0.25 and 0.25, respectively. The true vector sum of all the components at time 1 is

$$(\mathbf{L}^2 + \mathbf{V}^2 + \mathbf{T}^2)^{1/2} = (0.92 + 0.252 + 0.252)^{1/2} = 0.96 \text{ unit} \quad (2.1)$$

There may be another time when the peak true vector sum will be larger than that at the peak component and several should be checked. However, it usually occurs at the same time as the largest component peak. Peak motions should always be reported as either peak component or the peak true vector sum.

Another measure, the maximum vector sum, is frequently reported but is conservative and not directly related to a maximum velocity at a particular time. The maximum vector sum is calculated as shown in the above equation also; however, the maximum of each component is used regardless of the time when it occurs. Thus, for the same record in the example above if the peak of the vertical and transverse components are both 0.75 and occur at different time than time 1, then, the maximum vector sum is

$$(0.92 + 0.752 + 0.752)^{1/2} = 1.4 \text{ unit} \quad (2.2)$$

In general, the empirical observations of cracking have been made with single-component peaks; therefore, use of the maximum vector sum provides a large unaccounted safety factor. As a result of that, peak particle velocity, which is the maximum particle velocity among the radial, vertical, and transverse components recorded from the same blast event, should be taken into account instead of peak vector sum (Dowding, 1985).

#### **2.4. Frequency Properties and Durations**

The frequency of ground vibration can be defined as the number of cycles executed per unit time (second). Mathematically, it can be expressed as follows:

$$\mathbf{F = 1/ T} \quad (2.3)$$

Where F is the frequency and its unit is Hertz (Hz), and T is the time in seconds required for a complete oscillation.

The amplitude (A) of ground vibration is defined as a time varying and kinematical vibration quantity of displacement, velocity or acceleration. They all have instantaneous values at any instant together with the peak or maximum at some specific moments for any vibration record.

The amplitude, frequencies, and durations of the ground vibrations change as they propagate, because of (a) interaction with various geologic media and structural interfaces, (b) spreading out the wave-train through dispersion, and/or (c) absorption, which is greater for the higher frequencies. Therefore, the vibration frequency and consequently the velocity, displacement and acceleration amplitudes depend strongly on the propagating media. For instance, thick soil overburden as well as long absolute distance creates long-duration, low-frequency wave trains.

This increases the responses and damage potential of nearby structures (Siskind et. al., 1980).

The 1980 USBM's report indicates that frequencies below 10 Hz produce large ground displacement and high levels of strain, and also couple very efficiently into structures where typical resonant frequencies are 4 to 12 Hz for the corner or racking motions. It is also concluded that damage potentials for low-frequency blasts (<40 Hz) are considerably higher than those for high-frequency (>40Hz).

Other studies described the frequency character of vibration from quarry (Nicholls et. al., 1971), and coal mine blasts. (Wiss and Linehan, 1979) The combination of large charge shots, thick soil and sedimentary rock overburdens, relatively good confinement, and long-range propagation make coal mine blast vibrations potentially more serious than quarry and construction blasts because of their low frequencies. Hard rock construction and excavation blasts tend to be shorter in duration and contain higher frequency motions than those of either coal mine or quarry. (Stagg and Engler, 1980)

## **2.5. Methods of Measuring Frequencies**

Many researches done in the past have produced frequency-based velocity data without a clear definition of frequency or methods used to calculate frequencies. Frequency components of a vibration are equally important as the particle velocities. When the intent is to evaluate damage potential, the entire time history, or all frequency component, is an important factor to consider.

Frequency is most reliably computed by applying the Fourier frequency function, or FFT (Fast Fourier Transform), to transform the ground motion time histories (time domain) into the frequency domain. In this manner, the distribution of frequency

content can be compared based on relative intensities of ground motion at specific frequencies, and predominant frequencies can be easily identified.

In contrast, the “zero-crossing” method has been widely adopted by industry for determining and reporting a single frequency value at the peak velocity of ground motions measured in three directions (radial, transverse, and vertical) or the PPV. A problem arises when the peak frequency occurs in a complex vibration time history containing a variety of frequencies and amplitudes. If the peak velocity occurs early in the time history within the high frequency components (e.g. above 20 to 30 Hz), the zero-crossing method may result in a frequency well above the natural frequency range of residential structures, even if the entire time history contains a strong low-frequency component. This may not represent the frequency at which the maximum vibration energy is transferred into the structure.

Most seismograph analysis software provides a means to plot the “zerocrossing” frequency as well as the FFT frequency for every peak contained within the time history. In this respect, the vibration energy contained over all frequencies can be evaluated with respect to potential structure response (Aimone-Martin et al., 2003).

## **2.6. Impact of Natural and Technological Factors on Seismic Effects of a Blast**

### **2.6.1. Blasting conditions**

In industrial blasts the wave picture is extremely complex. This is due to the prevailing geo-mining conditions on the travel path of blast induced seismic vibrations and also due to the special nature of the blast as a source of elastic waves.

In describing such a source we can only consider approximation of the models as applied to the properties of the medium in which blasting takes place. In actual conditions, various endogenous factors such as, type of explosives, weight,



construction and shape of individual parts in a charge, the total charge in the block being blasted and initiation scheme as well as external factors such as properties of rocks, availability of free face, line of least resistance and depth of charge directly or indirectly influence the blast (Arseven, 2003).

### **2.6.2. Construction of explosive charge**

The properties of explosive used in the blasts primarily influence the intensity of the source of seismic vibrations. Explosives having low velocity of detonation (VOD) are preferred for conducting blasts to produce reduced seismic effects. Explosives with higher VOD generate significant vibrations. In their spectra, higher frequencies predominate, which absorb a major part of the energy. Therefore, while selecting explosives due consideration should be given to the requirements of fragmentation and absorbing properties of surrounding rocks at different phases in the frequency spectra of oscillation.

The most effective method of reducing blast induced seismic effects as well as enhancing the quality of fragmentation is to use inactive zones and air gaps and also inactive stemming. It has been established that the intensity of vibrations is reduced by 1.2-2 times, depending on the properties of surrounding rocks, when charges with in-between air gaps are used. However, the use of such charges reduces the seismic effects only at specific ratios of volume of air gaps to the entire charge volume in a particular deposit. This ratio is about 0.3-0.4 (Arseven, 2003).

### **2.6.3. Conditions of placing charges**

The conditions of charge placement influence the seismic effect of a blast. Maximum seismic effects are observed in blasts conducted in a confined medium. The depth of charge placement plays a vital role since with an increase in depth the intensity of vibrations also increases. Therefore, as the number of free faces

increases, the vibration velocity of rock decreases. In such a case, seismic effects may be reduced by as much as 4-5 times compared to blasting in a confined medium. In a series of investigations the change in seismic effects of a blast due to change in bench height or length of hole charge was considered. It was established that relatively rapid growth of particle velocity is noticed when the bench height is increased from 10 to 20m. The enhanced intensity of seismic vibrations can be explained by the increased consumptions of explosives per unit time of blast and also by the lengthening of charge (Arseven, 2003).

#### **2.6.4. Properties of rocks**

An important property is the acoustic rigidity of rock. Placing a charge in a medium of lower acoustic rigidity reduces the seismic effects of a blast. A blast in rocks of relatively greater acoustic rigidity produces 3 times more seismic energy at the source boundary, compared to blasts in rocks with lower acoustic rigidity.

Blasts in clays, marlstones and salts cause maximum ground movement due to the seismic wave. While blasting in hard rocks takes place, the expansion and development of existing fissuring affects the seismicity. As the specific fissuring increases, the seismic effect in large blasts reduces. At the same time, a vital role is played in not only by the number of fissures but also the expansion of their opening, filling by secondary products and spatial orientation. The spatial disposition of fissures also influences the seismic effects of a blast. By properly orienting the drill hole grid, the fragmentation and intensity of elastic vibrations can be regulated (Arseven, 2003).

Change in the physicommechanical properties of rocks at the site of blasting also influences the frequency composition of blast-induced vibrations. In rocks with a low value of acoustic rigidity, lower frequencies dominate compared to rocks with higher acoustic indexes.

### **2.6.5. Short delay blasting (SDB)**

SDB has advantages over instantaneous blasting such as possible control of ground vibration besides control of fragmentation, fly rock and trajectory of throw of the blasted rock mass. From the point of view of reducing seismic damage, SDB is a very effective method and in certain cases reduces the seismic effects of blasts to that of or even less than the effect of explosive weight used for a single delay.

Different technological measures are adopted which facilitate conducting of blasting operations without damaging structures in close proximity. Such measures include orienting the front of sismoblast vibrations, controlling the seismic effects by sequential blasting of different delays.

When selecting an optimal delay time based on the requirements to reduce interference in the propagation of sismoblast waves in a zone having structures to be protected, it is necessary to make the delay time compatible with the type of rocks, their acoustic properties and period of oscillation of waves. As the acoustic rigidity of rock decreases the delay time is increased. In limestone, the optimal delay time is 20-50 ms, whereas in weak rocks, delays with large intervals (50-80 ms) are preferred. In very hard rocks (some type of limestone), the scattering of delay time intensifies the seismic effects while in weak rocks the opposite is seen. To avoid the interference of seismic waves, it is necessary to see that the delay interval exceeds the duration of the positive phase of seismic wave.

Their effect on the seismicity of a blast is caused by the general redistribution of blast energy on generating elastic vibrations and breaking and displacing the rock. This effect is related to changes in line of least resistance in the block, angle of free action of charges, availability and formation of free faces in the blast. The diagonal row and trapezoidal cut schemes are widely used schemes of initiation from the point of view of maximum reduction in the seismic effects of a blast.

The seismic effects of a blast can be controlled even to a much greater extent by changing the commutation of charges so as to change the direction of wave front. The direction of the blast induced wave front depends on direction of initiation of the chain of charges, distance between them and the velocity of the longitudinal waves in the massif. After firing an elongated dispersed charge the velocity of rock displacement at points along the line of drill holes is constrained at the lower bound by the velocity of the single concentrated charge and at the upper bound by the velocity of entire concentrated charge in a direction normal to the row of drill holes in case of instantaneous blasting. Hence any structure to be protected may be located at the flank of the block to be blasted because it will direct the detonation from the structure side and thereby reduce the velocity of ground vibrations by 2-3 times in its neighborhood.

The trend towards larger blasts using a large number of delay intervals in a number of blocks, leads to the overall lengthening of blast cycle duration and consequently to the enhancement of seismic effects to structures to be protected. To reduce the seismic effects of a blast, the total time of blast duration should be reduced by optimally selected delay intervals and the number of delay groups (Arseven, 2003). According to Atlas (1987), ground motion dissipation in rock is attributed to three mechanisms:

1. Viscous damping of ground vibrations, an effect more pronounced on higher frequencies and accompanied by a trend to lower ground vibration frequencies with increasing distance from a blast.
2. Solid friction absorption of energy in the ground motion wave, which is greater for rock for coarser grain structures and extensive porosity.
3. Scattering of the ground motion wave due to reflections at discontinuities and strata inhomogeneities in the rock, in which interactions between reflected pulses are often accompanied by a trend to selectively attenuate lower ground vibration frequencies.

Since rock masses are inhomogeneous, ground motion waves travel through strata of different acoustical impedance. Scattering the ground vibration waves, initiated at boundary of discontinuities by reflections, lowers the peak vibration levels. Interactions between the reflected pulses alter the frequency composition of the wave train. High frequencies are selectively attenuated while some lower frequencies are added to the ground vibrations.

The presence of joints, fractures, faults and shear zones in the path of a ground motion wave also act to scatter the peak vibrations. Some of the lateral components of ground motion are lost as the wave crosses a discontinuity. The degree of redirection and dissipation of a ground motion wave is related to the nature and frequency of structural discontinuities in rock (Atlas, 1987).

## **2.7. Structure Response to Blast Excitation**

Blasting can cause significant vibrations within structures even in cases where the distance between a blast and the structure is large. High levels of vibration within structures are caused by a close match between the ground vibration frequency and the fundamental resonant frequency of the structure or some structural elements (Djordjevic et al., 1990).

Blasting induced ground vibration waves' structural damage potential depends on several parameters but mainly on the energy that they carry. The ground vibration or seismic energy is usually described as a time varying displacement (mm), velocity (mm/s), acceleration ( $\text{mm/s}^2$ ) and frequency (Hz). In accordance with Turkish Regulation, vibration velocity and frequency are taken into consideration for vibration evaluation in this report. Structural damage potential depends also on the method of construction, materials of construction, size of the building, and the ground characteristics on which they are built, as well as seismic wave characteristics (Siskind et. al., 1980). A detailed study is always necessary for this reason.

Allowable ground vibration levels are set and given in regulations of various countries abroad for a few decades. In Turkey, a new regulation is in force since June 1st, 2005 (Official Gazette No. 25862) in parallel with European Union Directive numbered 2002/49/EC and dated 25/6/2002 on evaluation and management of environmental noise. Turkish Regulation entitled “**Evaluation and Management of Environmental Noise**” (EMEN), is the first legal arrangement which sets limits on ground vibration in Turkey. EMEN article no.29 which sets the base and the limits for ground vibration is given below as it is.

**“Ground vibration criteria at inhabited areas for environmental sources**

**Article 29** — The basis, related to the control of environmental vibration induced by various sources, is given below:

- a) For the prevention of damage to the structures located around by the blasting operations at mines and quarries and similar sites, the vibration levels monitored and recorded in the ground outside the nearest building, can not exceed the limits given in Table 9 of the regulation. Monitoring is done in three mutually orthogonal directions and the maximum of these is taken into consideration. Vibrations are measured in 1/3 octave ranges and peak values are considered.

Table-9 Allowable peak ground vibration levels which is induced in the ground outside the nearest structure due to blasting at mines, quarries and similar sites

<b>Vibration Frequency (Hz)</b>	<b>Maximum allowable vibration velocity (Peak value-mm/s)</b>
1	5
4-10	19
30-100	50

(Velocity limit lines rise from 5 mm/s to 19 mm/s in the frequency range 1 Hz- 4 Hz, and from 19 mm/s to 50 mm/s in the frequency range 10 Hz- 30 Hz in log-log graph)”

Ground vibrations induced by blasting operations in mines are transient and irregular ground motions. The rate of motion of a particle in the ground is called as vibration velocity. Vibration velocity begins from zero, reaches to its peak value and attenuates with time. Accordingly the most important parameter in ground vibration analysis is the peak vibration velocity. This is because the structure responds and vibrates as much intense as the vibration velocity exciting it. Frequency ( $f$ ) indicates the number of oscillations per second of a particle in the ground and is described by Hertz (Hz).

Close to the blast the vibration character affected by factors of blast design and mine geometry, particularly charge weight per delay, delay interval, and to some extend direction of initiation, burden, and spacing. In other saying, the vibration velocity is an important damage indicator depending on the above mentioned parameters. At large distances the factors of blast design become less critical and the transmitting medium of rock and soil overburden dominate the wave characteristics. In other saying the ground properties and the wave frequency are important and decisive parameters on the occurrence of damage or non-damage. In this research investigation, Turkish Regulation, US Office of Surface Mining criteria (OSM-1983) and US Bureau of Mines criteria (USBM-1980) are taken into consideration to evaluate and interpret the monitoring results since all of them considers both the vibration frequency and the velocity. OSM-1983 criteria are the US Federal Regulation (30 CFR, Parts 715, 780, 816, and 817) in force at present. Both EU Directive No. 2002/49/EC and Turkish Regulation prepared in parallel to EU Directive are based on the same limiting values given in OSM-1983.

Vibration waves due to blasting in metal mines, quarries and construction sites are different than the vibration waves induced by blasting in coal mines (Dowding, 1996, Bilgin et. al. 2004, Bilgin et. al. 2005, Bilgin et. al. 2006). The coal mine shot is characterized by a trailing large-amplitude, low-frequency wave. The combination of large shots, thick soil and sedimentary rock overburdens, relatively good confinement, and long-range propagation make coal mine blast vibrations

potentially more serious than quarry and construction blasts because of their low frequencies (Siskind et. al., 1980). For this reason, the investigation of coal mine vibrations calls for special attention and interpretation. In metal mines such as Kışladağ Gold Mine, the damage risk is comparatively lower due to higher frequency (usually >10 Hz) of seismic waves depending on the ground properties (Bilgin et. al., 2007).

### **2.7.1. Structure Components and Ground Vibration Parameters**

Structures consist of many components, and two of most important are walls and superstructural skeletons. Superstructure response, measured at a corner, is associated with the shearing and torsional distortion of the frame, while the wall response, which measured in the middle of the wall, is associated with bending of that particular wall. The wall and superstructure continue to vibration freely after the passage of the ground motion, according to Dowding (1985). He also indicated that the wall motion tend to be larger in amplitude than the superstructure motions and tend to occur at higher frequencies during free vibration than those of the superstructure. Detailed studies (Dowding et al., 1980; Medearis, 1976) have shown that the natural frequencies of walls range from 12 to 20 Hz and those of superstructures from 5 to 10 Hz.

The response of any structure to vibration can be calculated if its natural frequency and damping are known or can be estimated. The fundamental natural frequency  $F_d$  of the superstructure of any tall building can be estimated from compilations of work in earthquake engineering (Newmark and Hall, 1982):

$$F_d = 1 / 0.1 * N \quad (2.4)$$

where, N is the number of the stories.  $F_d$  values can be compared favorably with results of actual measurements (Dowding, 1992).



Damping  $\beta$  is a function of building construction and to some extent the intensity of vibration. Measurement reveals a wide range of damping for residential structure with an average of 5% (Dowding et al., 1981).

Excessive structural response has been separated into three categories arranged below in the order of declining severity and increasing distance of occurrence (Nothwood et al., 1963; Siskind et al., 1980). Beginning with effects that occur closest to the blast, the categories are listed here:

1. Major (Permanent Distortion). Resulting in serious weakening of the structure (e.g. large cracks or shifting of foundations or bearing walls, major settlement resulting in distortion or weakening of the superstructure, walls out of plump).
2. Minor (Displaced Cracks). Surficial, not affecting the strength of the structure (e.g. broken windows, loosened or fallen plaster), hairline cracks in masonry.
3. Threshold (Cosmetic Cracking). Opening of old cracks and formation of new plaster cracks, dislodging of loose objects (e.g. loose bricks in chimneys) (Dowding, 1992).

### **2.7.2. Resonance and Amplification Factor**

The probability of damage in structures depends on the relationship between dominant frequency of the ground vibration and natural frequency of the structure. Most significant for blasting is that the principal frequencies of the ground motion almost always equal or exceed the gross structure natural frequencies of 4 to 10 Hz. In this case, structure resonates and it is shaken by amplified vibration a few seconds. People may still perceive and are concerned about this situation. While structure resonates, it may not be damaged but people may still complain even if particle velocity is much below the limiting vibration value. However, the damages

within the structures are caused when structure resonates at a particle velocity exceeding vibration limit. Although amplitude of the exciting wave traveling in the ground is not sufficient to cause damage to structure, structure may be damaged due to amplification during resonance. Amplification is defined as the increase in the amplitude measured in the structure with respect to ground amplitude due to the transfer of the exciting wave on the ground to the structure. The ratio of amplitude of the structure to ground amplitude is called as amplification factor (Esen and Bilgin, 2001).

Public concerns are completely due to the low-frequency and highamplitude ground vibrations as in the case of Can Lignite Mine, Turkey (Bilgin et al., 1998, Bilgin et al., 1999) where ground vibration levels are much below 12.7 mm/sec and no damages are encountered. It may be explained by the low frequency waves that people perceive. When the frequency is high, it is hard for humans to feel and they do not react. Since frequencies below 10 Hz create great displacements and high level unit deformations on ground, they increase the damage risk (Siskind et al., 1980)

### **2.7.3. Distinction of Blast-Induced Cracking from Natural Cracking**

Control of blast-induced transient effects to prevent threshold or cosmetic cracking reduces blast-induced displacement or strains in structures to below that caused by every day activities and change in the weather (Stagg et al., 1984; Dowding, 1988).

The blast induced threshold cracks can be scientifically observed only with visual inspection immediately before and after each blast. However, the multiple origins of cracks should be taken into consideration. Several institutional references (Anon, 1977; Anon, 1956; Thoenen and Windes, 1942) summarized that cracks basically are found to be caused by the following non-blast factors:

- 1- Differential thermal expansion.

- 2- Structural overloading.
- 3- Chemical change in mortar, bricks, plaster, and stucco.
- 4- Shrinking and swelling of wood.
- 5- Fatigue and aging of wall coverings.
- 6- Differential foundation settlement.

**2.7.4. Safe Levels of Blasting Vibrations for Residential Type Structures**

The safe levels of blasting vibration is given in Table 2.1, as determined by USBM taking coal mines into account which are the most risky in terms of structural damage. Safe levels of blasting vibration, that will not create any damage in residential type of buildings, are given in Table 2.1 with respect to structure types and wave frequencies (Siskind et. al., 1980). Criteria given in Table 2.1 are valid for the structures built on well constructed foundations, not having more than two stories, and the ground vibrations induced by blasting and having a few seconds duration.

Table 2.1 Safe levels of blasting vibrations (Siskind et. al., 1980, USBM).

Type of Structure	Ground vibration-Peak particle velocity (mm/s)	
	At low frequency (<40 Hz)	At high frequency (>40 Hz)
Modern Houses	19.0	50.8
Older Houses	12.7	50.8

Safe blasting limits given in Table 2.1 are determined lower than the levels at which the occurrence of threshold damage was observed during the research conducted at coal mines in USA. The limits given in Table 2.1 assume a 5 % cracking probability for very superficial cracks at 12.7 mm/s. In other saying, the given limits provide protection from superficial cracking in 95 % at about 12.7 mm/s (Siskind et. al.,

1980). However, the actual damage versus non-damage data shows zero probability at about 12.7 mm/s (Siskind, 2000).

US Office of Surface Mining (OSM) reviewed the criteria proposed by USBM and developed a workable distance dependent peak particle velocity (PPV) criteria (Table 2.2). These criteria are included in US Code of Federal Regulations (CFR).

Table 2.2 Maximum allowable peak particle velocity for blasting vibrations (OSM, 1983, 30 CFR, Parts 715, 780, 816, 817)

<b>Distance from the blasting site, m (ft)</b>	<b>Maximum allowable peak particle velocity, mm/s (inches/s)</b>	<b>Scaled distance factor to be applied without seismic monitoring</b>
0-92 (0-300)	31.75 (1.25)	50
92-1524 (301-5000)	25.40 (1.00)	55
>1524 ( $\geq$ 5001)	19.05 (0.75)	65

Maximum allowable limits given in Table 2.2 don't take the frequency and the structure type into account. Also it assumes that the structures are engineered and built according to building standards. However, the use of Table 2.2 is not preferred since the structures around Kışladağ Gold Mine are not engineered and built according to construction standards. Maximum allowable peak particle velocity is given as 19 mm/s in Turkish Regulation and US Federal Regulation for 4-10 Hz frequency range. However, it may be more appropriate to consider the limiting value of 12.7 mm/s proposed by USBM (1980) to remain at the safe side (Table 2.2). The above mentioned limiting value of 12.7 mm/s vibration velocity is the safe value which doesn't create hairline cracks at the plaster of old buildings. In other saying, it doesn't damage the skeleton and the load bearing walls of the buildings.

Both USBM and US OSM proposed alternative criteria taking the frequency of vibration waves into account (Figure 2.8). USBM criteria given in Figure 2.8 allows vibration velocities of 12.7 mm/s in the frequency range of 2.5-10 Hz, and 50.8 mm/s in the frequency range of 40-100 Hz. US OSM found USBM criteria conservative and very safe and rose the allowable velocity limits to 19.05 mm/s (19 mm/s in Turkish Regulation) for the frequency range of 4-10 Hz and 50.8 mm/s (50 mm/s in Turkish Regulation) for the frequency range of 30-100 Hz. Therefore it is possible to say that both Turkish Regulation and EU Directive numbered 2002/49/EC are based on OSM-1983 criteria (Bilgin et. al., 2007).

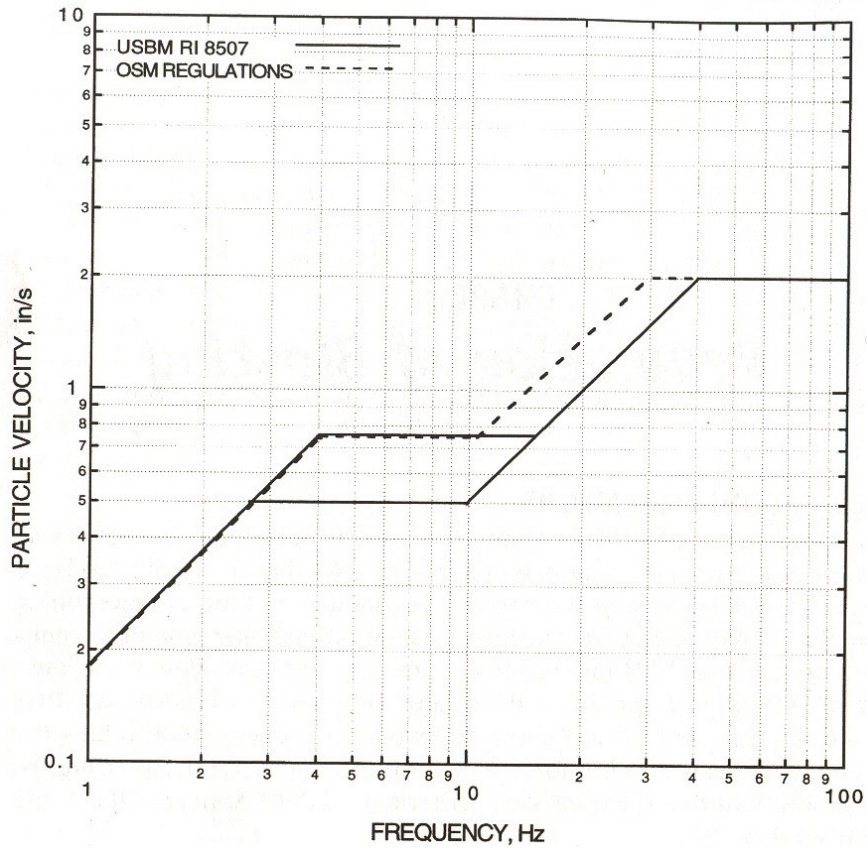

Figure 2.8 Safe level blasting vibration criteria for houses from USBM RI 8507 and the derivative version, the chart option from OSM Regulation (Siskind, 2000).

For the interpretation and evaluation in this research study, Turkish Regulation, USBM (RI 8507, 1980) and US OSM (OSM, 1983) criteria given in Figure 2.8 are all taken into consideration together. All of them consider not only the vibration velocity but also the frequency. USBM (RI 8507, 1980) criteria given in Figure 2.8 is on purposely taken into account to remain at the safe side and not to take any risks, since the buildings located at the settlements around Kışladağ Gold Mine are not engineered. For the same reason DIN 4150 standard given in Table 2.5 is also considered.

Allowable (safe) vibration levels as a function of seismic wave frequency, which will not cause any damage in structures, are given in Table 2.3 based on USBM RI 8507, 1980 criteria given in Figure 2.8 which is more conservative (safer) than Turkish Regulation.

Table 2.3 Allowable peak vibration levels as a function of seismic wave frequency (USBM RI 8507)

<b>Seismic Wave Frequency (Hz)</b>	<b>Allowable Vibration Velocity in Ground (mm/s)</b>
1	5
2.5-10	12.7
12	15.62
14	19.55
16	21.33
18	23.36
20	25.40
30	34.29
40-100	50.80

Table 2.4 Allowable peak component velocities in DIN 4150 Standard

Line No	Type of Structure	Peak Component Velocity (mm/s) at Foundation for Short Term Vibration		
		<10 Hz	10-50 Hz	50-100 Hz
1	Structures that, because of their particular sensitivity to vibration, do not correspond to those listed in rows 2 and 3, and are of great intrinsic value (e.g. buildings that are under a preservation order)	3	3-8	8-10
2	Dwellings and buildings of similar design and/or use	5	5-15	15-20
3	Buildings used for industrial purposes, industrial buildings and buildings of similar design	20	20-40	40-50

The German Standard DIN 4150, which was in force in Germany before EU Directive No. 2002/49/EC is valid, is the most restrictive and conservative vibration standard in the world (Table 2.4). The specified levels in DIN 4150 were not damage-based, but intended to minimize perceptions and complaints. They had no damage versus non-damage data, making the German standards very different and not applicable to USBM RI 8507 (Siskind, 2000).

## 2.8. Human Response to Blast Induced Ground Vibrations

Human response to blast induced ground vibrations may be the most decisive parameter for the control of ground vibrations. Humans notice and react to blast-produced vibrations at levels that are well lower than the damage thresholds for structures. The lowest levels of ground vibration that can be perceived by humans is about 1.5 mm/s and under special conditions this may be as low as 0.5 mm/s. Human response to vibrations depend on the particle velocity as well as the duration and the frequency of seismic waves (Bilgin et. al., 2000). In Figure 2.9 the degrees of perception of human beings are given depending on the duration of vibration

(Siskind et. al., 1980). The degrees of perception of humans described as “barely perceptible”, “distinctly perceptible” and “strongly perceptible” are shown in Figure 2.10 depending on vibration duration (0.1-5.0 seconds) and frequency range (4-25 Hz).

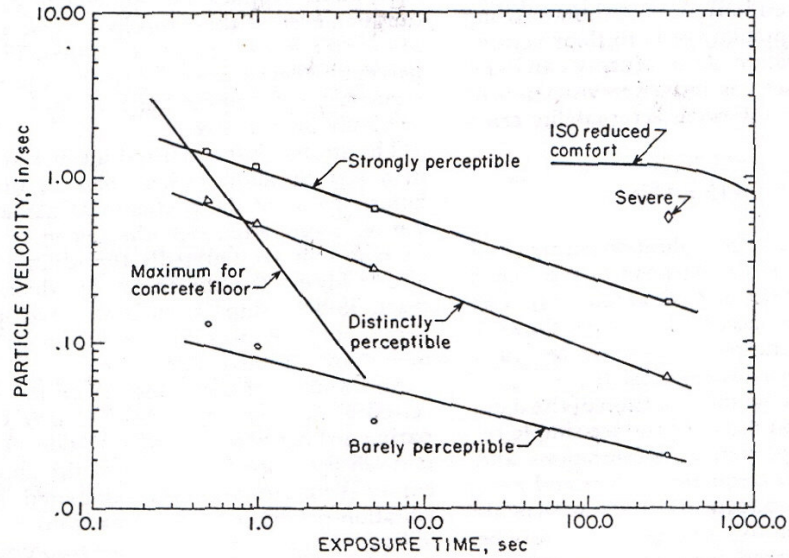

Figure 2.9 Human response to vibrations of various durations, summary. ISO values are from Standard 2631 (Siskind et. al., 1980).

Humans react and become anxious when they are subjected to ground vibration while they are sleeping, watching TV, reading, dining, and praying etc. The most important problems for the humans in the buildings are the fear both for the damage of the building and the possibility of injury (Siskind et. al., 1980; Siskind et. al., 1993). Sincere responses of humans should be taken in to account during the control of ground vibration even though the vibration level is very well below the allowable vibration levels for structural damage since the house rattling may result in secondary noises (Bilgin et. al., 2000). For this reason in case of presence of an inhabited area within a few hundreds of meters it is recommended not to conduct



blasting operations during activities that several inhabitants meet. Since Gümüşkol Village is 1109 m distant to the final pit boundary of Kışladağ Gold Mine, there is no necessity for this. The blasting operations at Kışladağ Gold Mine are carried out during day time and this is in accordance with the regulation.

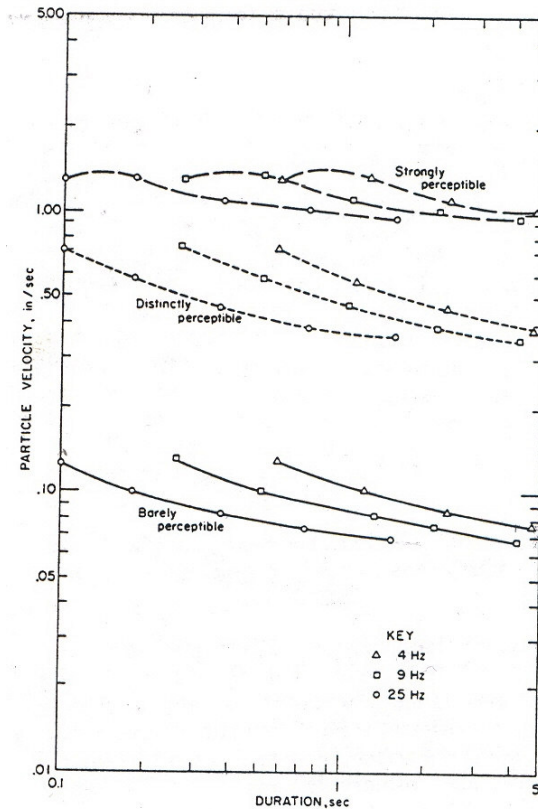

Figure 2.10 Human response to transient vibration velocities of various durations and frequencies (Siskind et. al., 1980).

There is no regulation which describes the effect of vibration on humans and gives the maximum tolerable limits in Turkey. For this reason, two standards developed by American National Standards Institute (ANSI) are used to interpret and evaluate the results in this report. Three possible physiological effects are defined by ANSI,

in order of increasing amplitudes of motion: (1) perceptibility and startle (comfort), (2) proficiency boundary or activity interference, and (3) health and safety. ANSI addressed whole-body vibration concerns for the general population in its standard ANSI S3.18-1979. This standard is basically for steady-state (e.g. a person operating a vehicle) rather than transient blast-like vibration and address issues of health, task proficiency and comfort. This standard is given in Table 2.5.

Table 2.5 Tolerable limits for vibration velocity (whole-body vibration for one-minute durations)

<b>Frequency, Hz</b>	<b>Comfort</b>	<b>Proficiency</b>	<b>Health limits</b>
4	35 mm/s	112 mm/s	224 mm/s
8-20	17.8 mm/s	56 mm/s	112 mm/s

ANSI has developed a separate standard numbered ANSI S3.29-1983 for the humans in buildings. This standard covers the condition of people not responding directly to the vibration but to the structure's response to the vibration, including all the secondary effects such as window rattling, superstructure groans and creaks, and movement of loose items on shelves and pictures on walls. This standard is given in Table 2.6. Table 2.6 lists PPV values for transient vibrations of less than 1-second duration for ANSI's worse case. A downward adjustment is used for events longer than 1-second.

Table 2.6 Peak vibration amplitudes tolerated by humans in buildings

<b>Number of events per day</b>	<b>1</b>	<b>12</b>	<b>26</b>
Residence, night	0.20 mm/s	0.09 mm/s	0.07 mm/s
Residence, day	12.70 mm/s	6.35 mm/s	4.30 mm/s
Office or workshop	18.00 mm/s	8.90 mm/s	6.10 mm/s

## 2.9. Determination of Scaled Distance versus Peak Particle Velocity Relation

It is necessary to determine the relations between scaled distance and peak velocities for longitudinal, vertical and transverse components and vector sum and peak particle velocity after taking the records by placing the seismographs to monitoring stations.

The scaled distance is a concept put forward by using the amount of explosive energy in air shock and seismic waves, and this affects the basis of distance. The scaled distance is derived by combining the distance between source and measurement points, and the maximum charge per delay. This scaled distance is defined by equation below (Dowding, 1985):

$$SD = R/Q^{1/2} \quad (2.5)$$

Where,

SD is the scaled distance ( $m/kg^{1/2}$ ),

R is the absolute distance between the shot and the station (m), and Q is the maximum explosive charge per delay (kg).

In ground vibration analysis preferably square root or rarely cube root scaling is used, whereas in air overpressure analysis cube root scaling is used.

The ground motion wave front resulting from a column charge (length to diameter ratio greater than 6:1) takes the form of an expanding cylinder. The volume of this compression cylinder varies as the square of its radius. Thus, the peak level of ground motion at any given point is inversely proportional to the square of the distance from the shot point (Dowding, 1985).

The peak particle velocity (PPV) is given by the following equation;

$$\text{PPV}(\text{mm/sec}) = K * (\text{SD})^{-\beta} \quad (2.6)$$

Where,

K is the ground transmission coefficient and,

$\beta$  is a specific geological constant.

The site factors are determined from a logarithmic plot of peak particle velocity (PPV) versus scaled distance (SD). The straight line best representing the data has a negative slope  $\beta$  and an intercept K at a scaled distance of 1.

This equation is used by several researchers at 50 % confidence in the early works. However, the equation with 50 % confidence is reliable only when the correlation coefficient, R, is close to unity. But, when the correlation coefficient is low this equation should not be used. In such cases, some researchers (Erkoc and Esen, 1998; Bilgin et. al., 1999) achieved successful increase in correlation coefficients in their detailed analysis. Fast Fourier Transform (FFT) analysis and filtering are among the scope of detailed analysis. But these operations are taking time and the software of the monitoring device must be capable of carrying out these operations (Bilgin et. al., 2000).

The most practical and reliable method is to determine the equation in 95 % confidence. 95 % confidence means the vibration value to be recorded during a future blast would be less than the vibration value predicted by the equation with a possibility of 95 %. This method of approach is provided by the software offered with some monitoring instruments or the researcher can compute by himself using the approach described by Dowding (1985), (Bilgin et. al., 2000). In this study, prediction equation with 95 % confidence (upper limit) is used to calculate safe distances or charge amounts in order to eliminate structural damage risk at all.

## **2.10. Previous Investigations for Damage Criteria**

Although many studies have been carried out to diminish environmental problems induced by blasting, a general reliable approach has not been established yet. The complexity of ground motions, blasting and test site factors restrict the establishment of a ground vibration criterion. Thus, experimental studies are still necessary for each site in order to minimize environmental problems, (Kahrman, 2001a). However, a number of investigators studied ground vibration induced by blasting and developed some theoretical and empirical approaches to explain the matter in detail. Therefore, a review of previous investigations for damage criteria is given below;

### **2.10.1. Vibration Energy as Damage Criteria**

(a) Rockwell's Energy Formula, 1934.

This formula considers frequency and amplitude as parameters for estimating the potential damage (Kahrman, 2001b).

(b) United States Bureau of Mines (USBM) formula, 1942.

It was the first USBM criteria concerning the blast-induced ground vibration and was based on amplitude, quantity and distance (Kahrman, 2001b).

(c) Crandell's Energy Ratio Concept, 1949.

This damage criterion is based on pre and postblast investigations, and it has recommended that no damage can occur below 3.0 of energy ratio.

### **2.10.2. Peak Particle Velocity as Damage Criteria**

(a) Particle Velocity Criterion of Langefors, Kihlstrom and Westerberg, 1958.

It was adopted for the first time by State of Pennsylvania to assess the damage potential of the ground vibration, and 2.0 in/sec used as an overall safe level for residential structures.

(b) Edwards' and Northwood's Particle Velocity, 1960.

This criterion is also based on the amplitude of particle velocity and damage type, and indicated that no damage can occur below 2.0 in/sec.

(c) USBM's Particle Velocity Criteria, 1971.

The Bureau of Mines studied various aspects of ground vibration, airblast, and seismic instrumentation, and published that in Bulletin 656 in 1971. Bulletin 656 established the use of peak particle velocity in place of displacement, and recommended to use 2.0 in/sec as an overall safe level for residential structure.

These recommendations were widely adopted by the mining and construction industry. However, soon after publication of the 2.0 in/sec safe level criterion, it became apparent that it was not practical to blast at this high vibration level. Many mining operations with nearby neighbors were designing their blast to keep velocities as low as 0.4 in/sec, and many homeowners were attributing all cracks to the blast vibration.

(d) Indian Standard Institute, 1973.

Particle velocity and rock type were the bases of this criteria.

(e) Canmet, Bauer and Calder's Particle Velocity Criterion, 1977.

The criterion considers particle velocity with connection to structure components and damage types, and adopted 0.5 mm/sec as a safe level.

### 2.10.3. Peak Particle Velocity and Frequency as Damage Criteria

(a) Langefors and Kihlstrom's Criterion, 1967.

Damage effects are described by peak particle velocity, and frequency, Table 2.7.

Table 2.7 Langefors and Kihlstrom's Criterion

Damage Effects	Peak Particle Velocity					
	Sand, gravel, clay below water level; c=1,000-1,500 m/sec <sup>1</sup>		Moraine, slate, or soft limestone; c=2,000-3,000 m/sec		Granite, hard limestone, diabase c=4,500-6,000 m/sec	
	mm/sec	in/sec	mm/sec	in/sec	mm/sec	in/sec
No noticeable crack formation	18	0.71	35	1.4	70	2.8
Fine cracks & falling plaster...	30	1.2	55	2.2	100	3.9
Crack formation.....	40	1.6	80	3.2	150	5.9
Severe crack.....	60	2.4	115	4.5	225	8.9

<sup>1</sup> Propagation velocity in media is given by c.

(b) Medearis's Approach, 1976.

Particle velocity and predominant frequency were the bases of the damage criteria.

(c) USBM's Criterion, According to Siskind et al., 1980.

Safe blasting vibration criteria were developed by USBM for residential structures, involving frequency, velocity, and displacement, Figure 2.11. Safe levels of ground vibration from blasting range from 0.5 to 2.0 in/sec peak particle velocities, and having two frequency ranges and a sharp discontinuity at 40 Hz. The criteria indicated that damage potentials for low-frequency blasts (<40 Hz) are considerably higher than those for high-frequency blasts (>40 Hz), with the latter often produced by close-in construction and excavation blasts.

Moreover, practical safe criteria for blasts that generate low-frequency ground vibrations are 0.75 in/sec for modern gypsumboard houses and 0.5 in/sec for plaster on lath interiors. For frequencies above 40 Hz, a safe particle velocity maximum of 2.0 in/sec is recommended for all houses (Siskind et al., 1980).

(d) German DIN Standard 4150, 1993,

German Institute of Standard developed a criterion for vibration effects on structures based on peak particle velocity, frequency, and type of structures. This criterion is illustrated in Table 2.9 and in Figure 2.11 (Nick, 2002)

Table 2.8 Guideline value of vibration velocity, DIN 4150, 1993 (Nick, 2002)

Line	Type of Structure	Vibration Velocity (mm/sec)		
		Foundation Frequency		
		Less than 10 Hz	10 to 50 Hz	50 to 100* Hz
1	Buildings used for commercial purposes, industrial buildings and buildings of similar design	20	20 to 40	40 to 50
2	Dwellings and buildings of similar design and/or use	5	5 to 15	15 to 20
3	Structures that, because of their sensitivity to vibration, do not correspond to those listed in lines 1 and 2 and are of great intrinsic value (eg buildings that are under a preservation order)	3	8 to 10	8 to 10
* For frequencies above 100 Hz, at least the values specified in this column shall be applied				



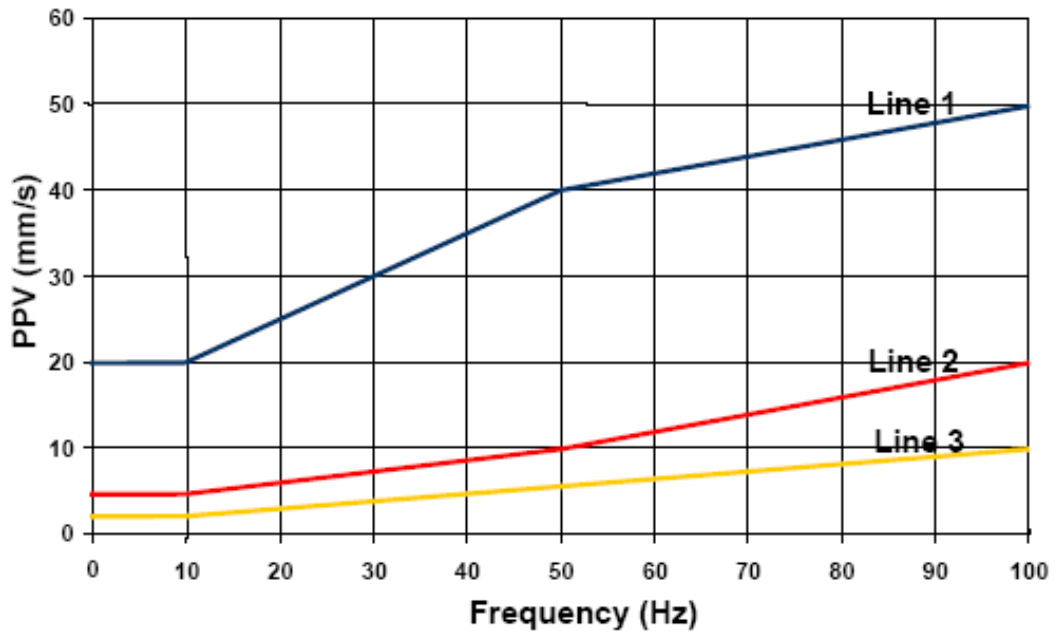

Figure 2.11 Curves representing the vibration velocity as a function of the frequency

(e) Indian CMRI Standard, 1987.

This criteria depending mainly on peak particle velocity and frequency associated with specification of structures (Kahrirman, 2001b).

#### 2.10.4. Peak Particle Velocity and Scaled Distance as Damage Criteria

(a) Federal Regulations of United States Office of Surface Mining (OSM), 1983.

The Office of Surface Mining (OSM) adopted a modification of the USBM's safe blasting criteria, 1980, which allows three methods for a blasting operation to demonstrate compliance, i.e. the maximum overall peak particle velocity (PPV) method, the scaled charge weight/ distance method, and the velocity-frequency chart method.

In this figure, note that the 2.0 in/sec range begins at 30 Hz as distinct from the USBM RI 8507 range which begins at 40 Hz. It also indicated that at large distance a lower peak particle velocity, 0.75 in/sec, and a large scaled distance,  $SD = 65$ , are mandated. At the shorter distances, a higher peak particle velocity, 1.25 in/sec and a smaller scaled distance,  $SD = 50$ , are permitted.

However, Dimitrios et al., (2001) recommended that in many projects located in urban areas, the vibration thresholds should be based more on human response than the probability of structural damage or harmful effects. The human reactions to blasting, however, was considered to be the limiting factor as shown earlier in the USBM's study in 1980.

Present regulatory control limits in many countries are below those levels at which cosmetic cracking may appear. There are two principle reasons for such tight restrictions. First, regulatory limits are influenced heavily by human response to blast-induced vibration and noise. Since humans are approximately 10 times more sensitive than structures to vibration, low regulatory limits are understandable.

Second, many regulations appear to have been adopted without the documented, scientific experimentation necessary to determine the vibration levels that cause cracking. In general, appropriate vibration thresholds, in conjunction with systematic vibration monitoring and continuous information of the residents, appease public anxiety. Hence, the mining and construction projects are protected from unjustifiable complaints, which, in some cases, can create obstacles, which are hard to overcome.

## CHAPTER 3

### MINE SITE AND GEOLOGY

#### 3.1. Mine Site

Mine site is located in the northwest region of Ulubey and İnay township of Uşak province, near the Gümüşkol and Sogutlu Village of Ulubey Township and Katrancılar District of Esmе Township in the western region of Turkey (Figure 3.1). The measurements are taken at Uşak Kışladağ Open Pit Gold Mine which is operated by TÜPRAG Metal Madencilik Sanayi ve Ticaret Ltd. Sti. Kışladağ Gold Mine Management carries out bench blasting operations at Uşak Kışladağ Open Pit Mine both for ore production and the stripping (removal of cover rocks), as well as presplit blasting operations for bench stability. Gümüşkol Village, its Micanlar District, and Karapınar and Katrancılar districts are located around Kışladağ Gold Mine. At present, the stripping and required blasting operations are done at distances varying between 1310 meters to 1460 meters from the Gümüşkol Village, 2050 meters to 2090 meters from the Karapınar District and 1650 meters to 1880 meters from the Katrancılar District. However the mine will expand and come closer to the Gümüşkol Village, its Micanlar District, and Karapınar and Katrancılar districts in the future. After the expansion of the mine, the final border will be located 1110 meters from the Gümüşkol Village, 1400 meters from the Karapınar District, 1370 meters from the Katrancılar District. In Figure 3.2 general view of Uşak Kışladağ Open Pit Gold Mine from the mine site is presented. The final pit boundary of the Uşak Kışladağ Open Pit Gold Mine, the Gümüşkol Village, Karapınar and Katrancılar districts and the monitoring stations are shown in Figure 3.3. In Figure 3.3, the closed red line in zig zag form shows the final pit boundary. Within the final pit boundary, red colored star symbols indicate the locations of the production blast rounds, whereas blue colored small circles represent the locations

of the presplit blast groups. The locations of monitoring stations are marked by yellow small squares with blue colored boundaries for Karapınar and Katrancılar districts and red colored boundaries for Gümüşkol Village. The codes of monitoring stations are written in black beside the small squares.

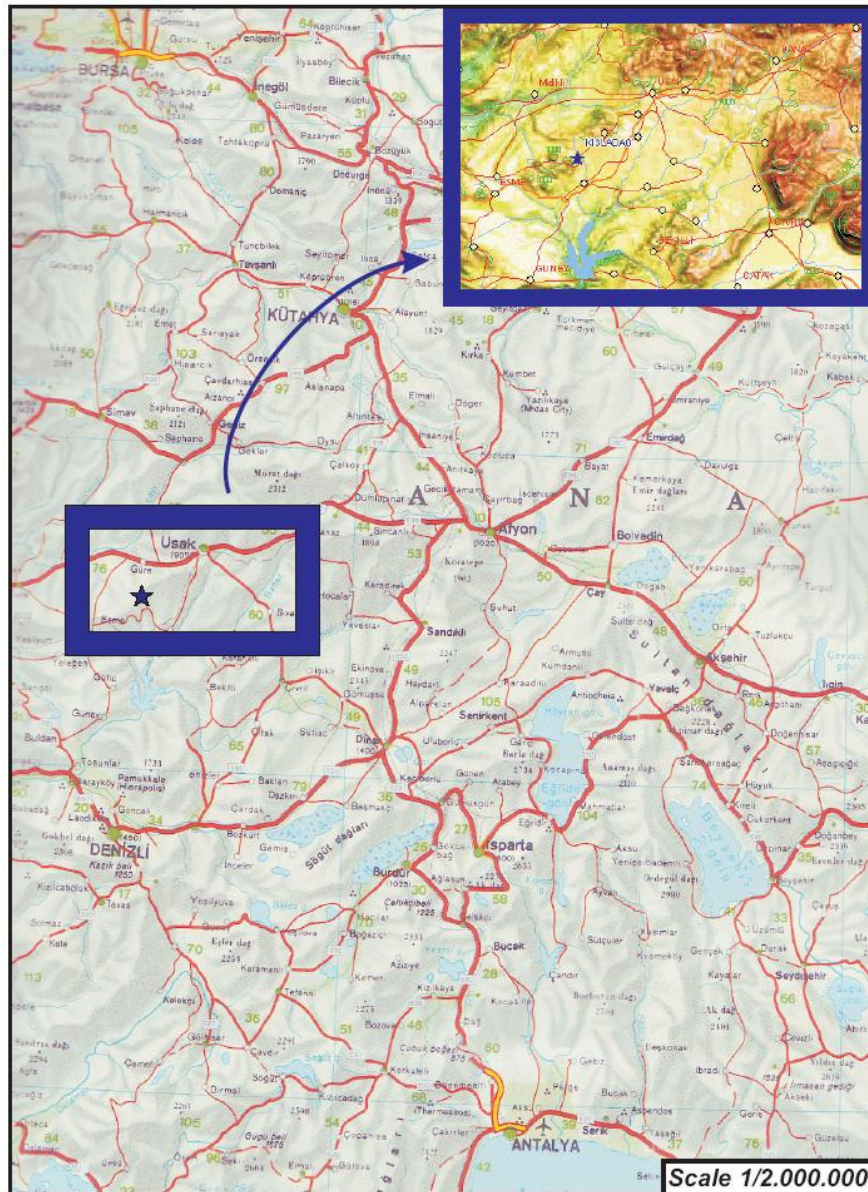

Figure 3.1 Location of the mine site



Figure 3.2 General view of Uşak Kışladağ Open Pit Gold Mine from the mine site.



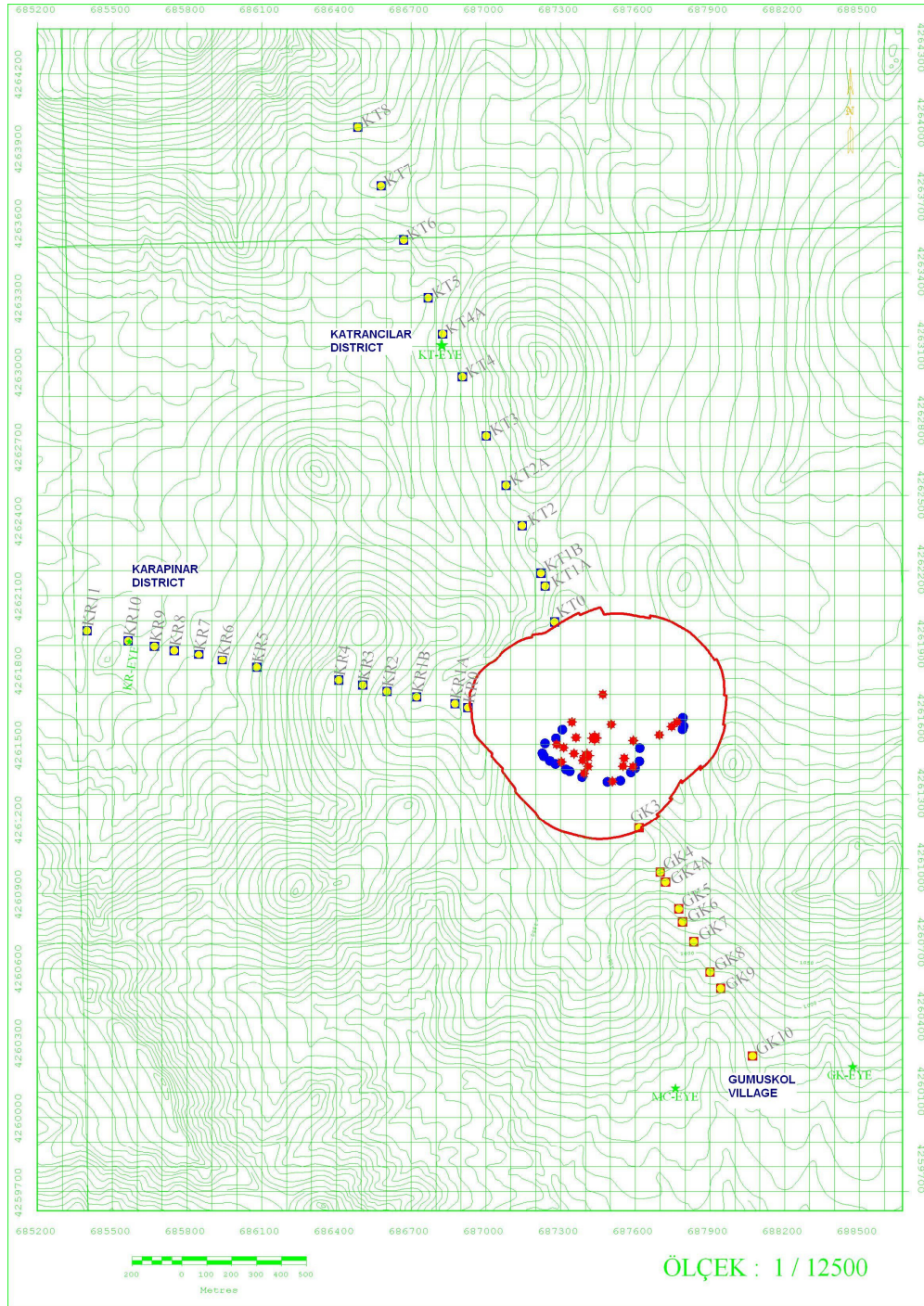

Figure 3.3 Final pit boundary of the Uşak Kışladağ Open Pit Gold Mine, the Gümüşkol Village, Karapınar and Katrancılar districts and the monitoring stations

## **3.2. Geology**

### **3.2.1. Introduction**

The Kışladağ project area occurs within intrusive, extrusive, and volcanoclastic rocks of an eroded Pliocene stratovolcano, which is emplaced within and overlies regional pre-Cretaceous basement schists and gneisses of the Menderes Metamorphic Complex (Orhan, 2004). The volcanic and intrusive rocks at Kışladağ extend well beyond the property boundaries, and are assigned to the Beydagi Volcanic sequence. Away from the volcanic centers, rocks of the Beydagi Volcanic sequence interfinger with and grade into partially coeval clastic sedimentary rocks and lacustrine limestones of the Ulubey and Ahmetler Formations (Lewis Geoscience Services Inc., 2002). Rocks belonging to Beydagi Volcanic sequence are exposed at the mine site, and within the close neighborhood, at Gümüşkol Village, its Micanlar District, Katrancılar and Karapınar Districts. Light brown colored soil cover is observed with a thickness varying between 0.2 to 0.4 meters almost everywhere except the outcrops of main lithological units. Depth of soil cover may reach to 1.5-2.0 meters at places, however the thickness of soil may rarely be greater in some agricultural areas (Orhan, 2004).

Most igneous rocks of the Beydagi Volcanic sequence are porphyritic with a phenocryst assemblage of plagioclase, K-feldspar, biotite, hornblende, with or without quartz. They probably represent only a small compositional range within a comagmatic suite, and the petrographic studies completed to date identify them to have a latite composition (Lewis Geoscience Services Inc., 2002). Although these volcanic rocks have been identified as andesitic in some previous studies conducted at the region, they have latitic composition within the project area (Orhan, 2004).

At the north of project area, massive to flow-banded porphyritic rocks of latitic composition with rare quartz are observed. Flow rocks occur as discontinuous,

tabular units of up to several tens of meters thick and interstratified with fragmental rocks. Monolithologic breccias observed at north interfinger or overlie the latite flows. At the south of mine site area (Gümüşkol Village direction) massive porphyritic quartz latite flows form a layer 10-20 meters thick within volcanoclastic (stratified tuffaceous and epiclastic) rocks. In most parts of the surrounding area the volcanoclastic sequence overlie the latite flows and monolithologic breccias.

In summary, the main lithologic rock units are massive or flow-banded, latitic, flow rocks with or without quartz, volcanic breccias, stratified tuffaceous and epiclastic rocks, volcanic conglomerates, fine crystal tuffs, lapilli tuffs or tuffaceous siltstones. The neighboring inhabited areas are located generally on Beydagi Volcanic sequence. The dominant frequencies of seismic waves are determined to be 10 Hz or above during the research work conducted by the University at some other sites where the ground conditions are almost the same and similar types of volcanic rocks prevails. During the monitoring study that will be carried out in this site, a similar behavior is expected for the seismic wave frequency range. For this reason, in case of low levels of ground vibration velocity that will be monitored, the possibility of structural damage at neighboring settlements is expected to be low accordingly.

### **3.2.2. Lithologic Units**

The Kışladağ project area occurs within intrusive, extrusive, and volcanoclastic rocks of an eroded Pliocene stratovolcano, which is emplaced within and overlies regional pre-Cretaceous basement schists and gneisses of the Mendere Metamorphic Complex. The volcanic and intrusive rocks at Kışladağ extend well beyond the property boundaries, and are assigned to the Beydagi Volcanic sequence. Away from the volcanic centers, rocks of the Beydagi Volcanic sequence interfinger with and grade into partially coeval clastic sedimentary rocks and lacustrine limestones of the Ulubey and Ahmetler Formations. Rocks exposed at



surface in the map area belong to either the basement schists and gneisses, or the Beydagi Volcanic sequence.

#### **3.2.2.1. Outcrop Lithology Codes**

Most igneous rocks of the Beydagi Volcanic sequence are porphyritic with a phenocryst assemblage of plagioclase, K-feldspar, biotite, hornblende,  $\pm$  quartz. They probably represent only a small compositional range within a comagmatic suite, and the petrographic studies completed to date identify them to have a latite composition (Northcote, 1999).

Textural variations within the latites range from massive porphyritic rocks of probable hypabyssal or flow origin, to polyolithic fragmental rocks of epiclastic origin. The massive porphyritic rocks can have crowded phenocryst textures, and K-feldspar phenocrysts up to a centimeter long are present locally. Flow banding is variably developed, and can be present within both intrusive and extrusive porphyries.

#### **3.2.2.2. Basement Metamorphic Rocks (pCM)**

The basement metamorphic rocks show a compositional range from biotite-rich mafic schists, to highly quartzose siliceous schists. Compositional layering can occur on the scale of centimeters to meters or tens of meters. Exposures of the basement sequence within the project area are insufficient to define mappable subunits on the basis of this compositional variation.

#### **3.2.2.3. Beydagi Volcanic Sequence**

The Beydagi Volcanic Sequence contains a variety of rock types consistent with the stratovolcano setting in which it formed. Most of the volcanic sequence in the present mine site consists of coarse fragmental rocks, flows, and porphyritic

intrusions, representing lithofacies proximal to the volcanic center. These units grade laterally into coeval distal volcanoclastic facies, siltstones, and limestones just outside of the map area boundaries.

#### **3.2.2.3.1. Latite Flows (PBf)**

Massive to flow-banded porphyritic rocks containing a phenocryst assemblage of plagioclase, K-feldspar, biotite, hornblende, and rare quartz are exposed in the northern project area. They form discontinuous, tabular units up to several tens of meters thick, occur both immediately above the basement unconformity, and higher in section interstratified with fragmental rocks. Phenocrysts can form up to 40% of the rock volume, and are enclosed in a very fine-grained to aphanitic groundmass. Most phenocrysts are less than 3-4 mm in maximum dimension, with the exception of coarse K-feldspar crystal, which can reach a centimeter in length.

Most outcrops of latite flows contain flow banding, which varies from a weak parting, to a strong alignment of phenocrysts that imparts a strong fissility on the rock. This flow banding is contorted by flow folds that have open to tight or isoclinal forms.

#### **3.2.2.3.2. Quartz Latite Flows (PBq)**

In the southern part of the proposed waste dump area, massive porphyritic quartz latite flows form a layer 10-20 meters thick within a volcanoclastic rock-dominated package. The quartz latite flows are texturally similar to the latite flows, with the primary difference being the presence of up to 2-3% conspicuous, subrounded quartz phenocrysts in the former. Monolithologic breccias occur locally as lenses along the contacts of the flows. In contrast to the latite flows, flow banding is rare to nonexistent.

#### **3.2.2.3.3. Monolithologic Breccia (PBb)**

Monolithologic breccias form much of the Beydagi Volcanic sequence. The breccias are at least several tens of meters thick. They lack visible stratification on the outcrop (meter to sub-meter) scale, but slopes underlain by the breccias of ten have linear, subhorizontal ledge-forming outcrops, suggesting layering may exist on the scale of several meters to tens of meters.

The monolithologic breccias are best interpreted as autoclastic flow breccias, deposited in a vent-proximal volcanic environment.

#### **3.2.2.3.4. Stratified Tuffaceous and Epiclastic Rocks (PBvc)**

The volcanoclastic sequence appears to overlie the latite flows and monolithologic breccias. However, the latite flows and breccias grade laterally into lithologically similar volcanoclastic units. The stratified volcanoclastic section includes rocks ranging from coarse, monolithologic to slightly heterolithic breccias and conglomerates, to welded lapilli tuffs, to fine crystal tuffs or tuffaceous siltstone. These rocks include both primary pyroclastic products (welded tuffs), and reworked (epiclastic) deposits. Fine-grained tuffaceous rocks contain well-defined laminations to thin beds, whereas stratification in the breccias and conglomerates, if present at all, is poorly defined and on the meter scale.

#### **3.2.2.3.5. Volcanic Conglomerate (PBcg)**

A sequence of coarse fragmental rocks consists of clast to matrix-supported, monolithologic latite volcanic conglomerates to breccias. Clasts within the unit are lithologically similar to the latites. Although they share some lithologic characteristics, these rocks differ from the monolithologic volcanic breccia in that they contain subrounded clasts, common megaclasts exceeding a meter in longest

dimension, and matrix supported interval. They are distinguished from the volcanoclastic sequence by their lack of stratification.

#### **3.2.2.3.6. Intrusive Rocks (PBi)**

Intrusive subunits defined include the following:

1. An early, pre-mineralization phase (phase 1) consists of strongly to intensely altered rocks, and forming outermost parts of the intrusive complex.
2. Syn-mineral phase 2 forms an east-west elongate stock cutting phase 1, weaker alteration than phase 1, and the presence of abundant, relatively unaltered magmatic biotite. Contacts between phases 1 and 2 are subvertical.
3. Phase 3, termed "microdiorite", is a late-mineral, less altered circular stock occurring in the center of the intrusive complex, is significantly less altered than the earlier phases. Contacts with older phases are subvertical.

### **3.3. Structural Geology**

#### **3.3.1. Pre-volcanic Deformation**

Basement metamorphic rocks in the project area contain strong to intense tectonic fabrics that formed prior to volcanic activity, presumably during a regional deformation associated with orogenic activity. Although this deformation clearly predates mineralization, there is potential that major structures that were active at this time may have been reactivated and helped to localize subsequent magmatic and/or hydrothermal events. Structural fabrics in the basement sequence were not examined in detail in this study, but the following characteristics are common:

- Foliation is defined by compositional layering and grain orientation fabrics, and in most areas is subhorizontal to gently dipping (<20°). The foliation imparts a strong schistosity in micaceous outcrops, and in siliceous rocks, can have a mylonitic character defined by highly-elongate quartz ribbon grains.

- Foliation surfaces, especially within the mylonitic siliceous rocks, commonly contain a moderate to strong mineral lineation, which trends approximately north-south.
- Asymmetric grain-scale fabrics, include C-S foliation and shear bands, attest to northerly-directed shear strain associated with formation of the composite foliation/lineation.
- The metamorphic rocks commonly contain closely-spaced joint sets absent from the overlying volcanic sequence. These joint surfaces typically have steep dips, and are either perpendicular to or form conjugate sets equally inclined to the mineral lineation; thus, they are best interpreted as having formed during late stages of the regional metamorphic event.

### **3.3.2. Syn- and Post- Volcanic Deformation**

Deformation within the Beydagi Volcanic sequence is minor. No mappable fault offsets of lithologic contacts have been recognized and the gentle stratigraphic dips in sequence suggests that little or no fault-related tilting has occurred. Fracturing is most pronounced in rocks adjacent to intrusive contacts, where anomalously steep bedding dips (up to 45°) may also occur. This probably reflects both strain localization at competency contrasts, and deformation related to the emplacement of the intrusion itself.

### **3.4. Rock Mass Property Description**

The rock masses exposed within the pit (Figure 3.4) and at the road cuts along Gümüşkol Village path (Figure 3.5) are studied and described well from engineering geology point of view. Since the rock masses existing along Karapınar and Katrancılar monitoring paths are not exposed, that is covered by vegetation, forest, thick soil or talus cover, they could not be described unfortunately.



Figure 3.4 The rock masses exposed within the pit

56



Figure 3.5 The rock masses exposed at the road cuts along Gümüşkol Village path

Detailed discontinuity survey is conducted within the pit and at the road cuts along Gümüşkol path. The dip direction and dip amounts of 106 discontinuities (Appendix F, Table F.1) are measured in the pit and analyzed by the software 'Rockscience Dips Version 5'. The concentration of the poles is shown in Figure 3.6 for the discontinuities measured in the pit. It is understood that there are four joint sets. The joint set 1 and 2 are major sets. The dip direction and dip amounts of four joint sets observed in the pit are:

Dip direction/dip :

Joint set 1: 327/62

Joint set 2: 061/58

Joint set 3: 105/84

Joint set 4: 001/67

At the road cuts along Gümüşkol path, 83 discontinuities (Appendix F, Table F.2) are measured by geologist's compass for which the analysis result is presented in Figure 3.7. It is understood from Figure 3.7 that there are four joint sets given in decreasing order of observation. The joint set 1 and 2 are major sets. The dip direction and dip amounts of four joint sets observed along road cuts are:

Dip direction/dip :

Joint set 1: 308/80

Joint set 2: 081/87

Joint set 3: 200/88

Joint set 4: 282/83

The joint sets also have got similar properties. The continuity is 8 m on average (minimum 5 meters up to 30 meters). Spacing varies from 2 cm up to 60 cm in the first set, whereas the spacing changes between 2 cm and 80 cm in the second set.

Separation of the joint sets varies from 0 to 10 mm in general. The separation is less than 1 mm where the rock is slightly weathered. The separation usually observed as 0-5 mm thick with clay infilling. The weathering of rock penetrates up to 10 mm depth from joint surface from place to place.

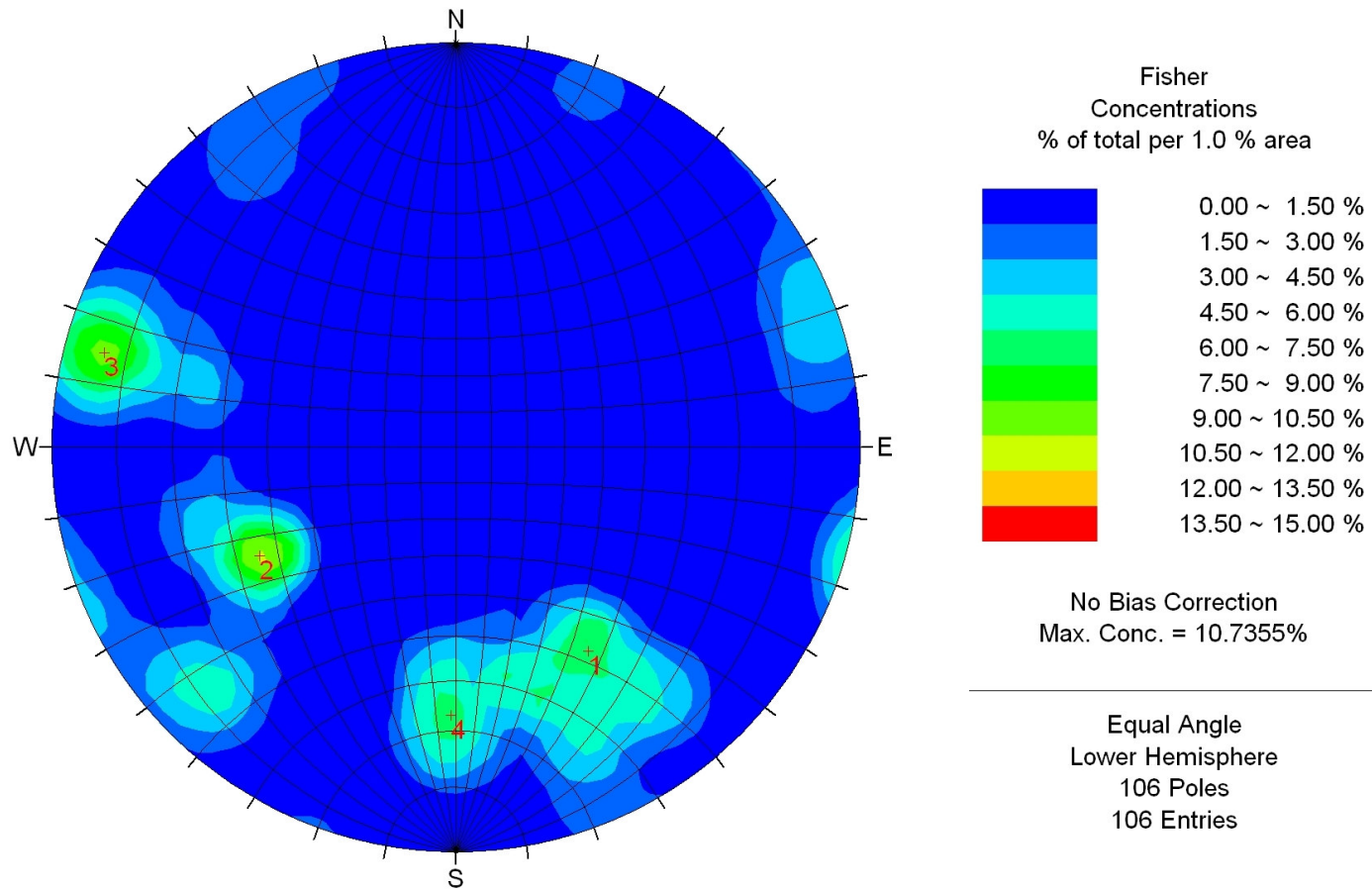

Figure 3.6 The dip direction and dip amounts of 106 discontinuities that are measured in the pit and analyzed by the software 'Rockscience Dips Version 5'



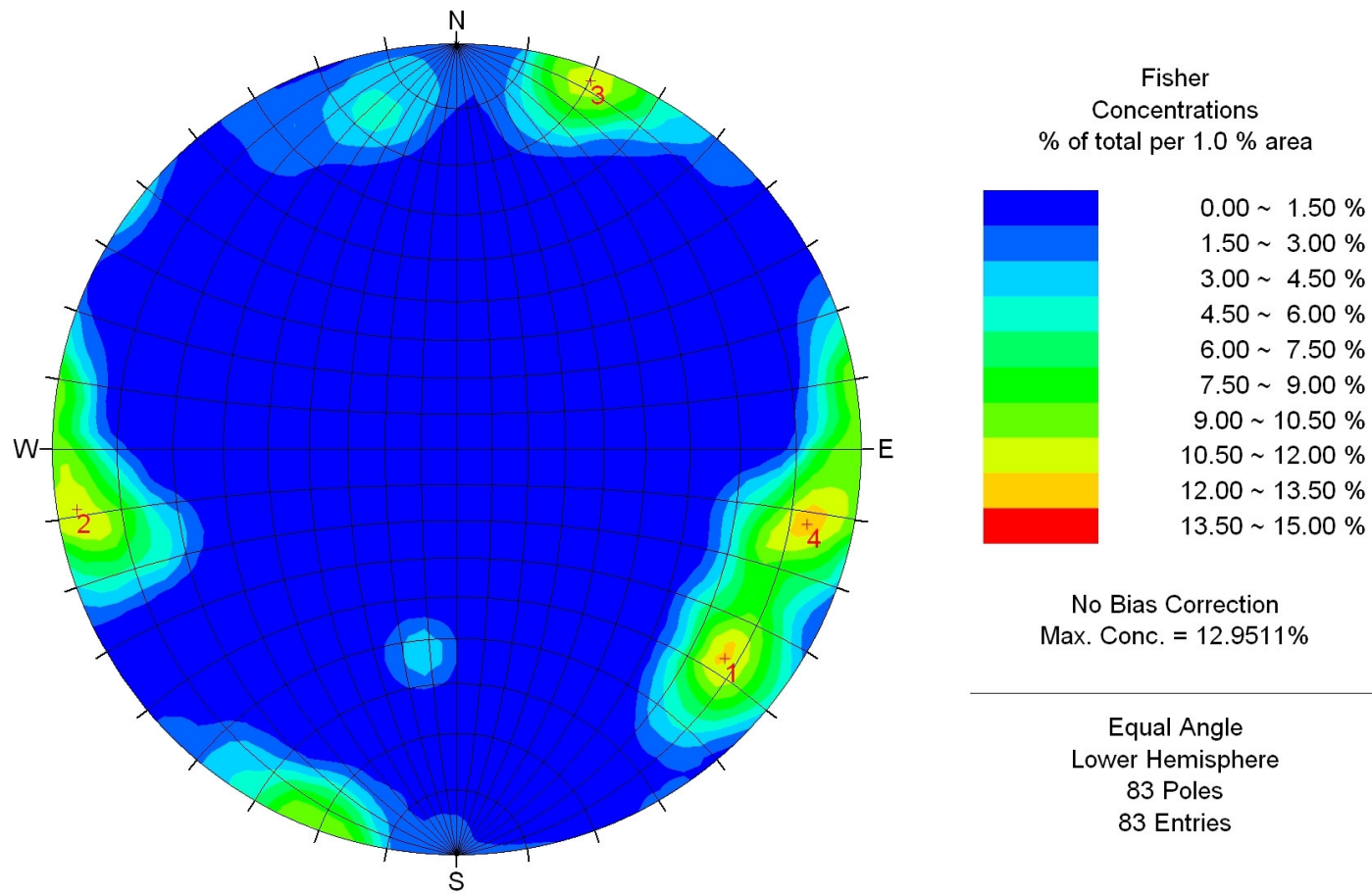

Figure 3.7 The dip direction and dip amounts of 83 discontinuities that are measured at the roadcuts along Gümüşkol path and analyzed by the software 'Rockscience Dips Version 5'

Almost all the joint surfaces are surface stained with some degree of weathering. But at some places the joint surfaces are slickensided and contain clay coating, which are the evidence of past movements (shearing) in the rock mass.

The intact rock strength as measured in the laboratory varies from 60 to 80 MPa depending on the degree of weathering as well. The recorded properties of the rock mass give RMR values varying between 47 and 69 depending on the degree of weathering and the ground water condition. So the rock masses, consisting mainly of volcanoclastic rocks along monitoring paths and latite porphyritic rocks inside the pit, are classified as fair to good rocks.

## CHAPTER 4

### BLASTING METHOD AND MONITORING PROCEDURE

#### 4.1. Introduction

First of all, the information about the blasting operations is gathered, the mine site and the blasting sites are visited, and the ground conditions are observed in situ, and the data on geology are obtained by the university research team. The method of work is observed and the blasting parameters are investigated during the site visit. The surrounding settlements are visited and coordinates of the structures closest to the mine are recorded using GPS. Approximate locations for monitoring stations are selected. Later the final pit boundary is determined in situ using the provided information; the distances between neighboring settlements and the final pit boundary are calculated. The paths for monitoring vibration are determined between the mine and the neighboring settlements. The monitoring stations along the paths are marked. Finally the coordinates of each monitoring station are exactly determined by surveying technique to finalize the monitoring locations. The distance calculations are updated and finalized.

Gümüřkol Village, Micanlar (Ozcanlar) District of this village, and Karapınar and Katrancılar Districts located around Kışladağ Surface Gold Mine are shown in Figure 4.1. The final boundary of open pit mine is marked with blue colored line in Figure 4.1. The locations of production blasts are shown by blue star symbols, whereas that of presplit blasts are marked by red circle symbols in the figure. The monitoring stations, selected along the paths towards Gümüřkol Village, Katrancılar District and Karapınar District are marked by light blue colored square symbols. The codes (consisting of letters and numbers) given to monitoring stations

are written in red nearby the light blue square symbols. The buildings in settlements are marked as small dark blue colored squares.



Figure 4.1 Uşak Kışladağ Open Pit Mine final boundary, neighboring settlements and monitoring paths

During the monitoring work, the devices are installed 122 times at the monitoring stations, but in 15 trials no records are obtained due to the low level of vibration or airblast. The number of vibration records obtained during monitoring is 107. Out of 107 records, 42 records are obtained from the monitoring stations along Gümüşkol path. 34 records are taken from the stations located along the path between

Katrancılar District and the mine. The number of records obtained from the stations located along the path between Karapınar District and the mine is 31.

The blast holes' locations are determined by measuring their coordinates before each blast. On the other hand, a copy of blasting pattern and the charts related to each blast, designed and documented by the engineering team is obtained and investigated. The investigations of blast plans are done separately for production and presplit blasts. Each blast hole in production blasts is planned and practiced to detonate separately irrespective of the total number of blast holes available in each blast round. By this way, the hole number with the maximum charge amount per delay is determined and its coordinates are taken into consideration in the distance calculation.

The results of monitoring realized during the blasts conducted in panels are arranged and given in tables and analyzed in detail to assess the environmental impacts. The dominant frequencies of the seismic waves propagating in the ground are determined and the safe explosive amounts that can be detonated per delay are calculated separately using the propagation law for each of three monitoring paths. In addition, safe explosive amount tables are prepared for different physical distances.

#### **4.2. Methods of Mining and Blasting Practiced**

Kışladağ Gold Mine is a typical porphyry gold deposit consisting of several intrusions surrounding a central intrusion. Waste rocks exist both above and in between the intrusions carrying gold. The ore and the waste rocks are both strong and hard and necessitate blasting. The open pit mining method with bench blasting is practiced for both the ore and the waste rocks utilizing excavator-truck system. The pit is at its early stages at present and new benches are formed. Bench blasting is used for ore production at newly and the previously formed benches. On the other hand, presplit blasting is carried out for improving bench stability.

#### 4.2.1. Production Blasting Parameters

The bench blasting parameters practiced in the pit at present are determined by observations made in situ. The holes in the front row of a blast round are drilled shorter, whereas those at the back rows are drilled longer to form new benches in natural sloping ground, since the pit is developing and at its early stages (Figure 4.2). The depth of blast holes in front row is usually 3.5 meters. The depths of blast holes in the back row of a blast round are 11 meters in general, since the bench height is determined as 10 meters.

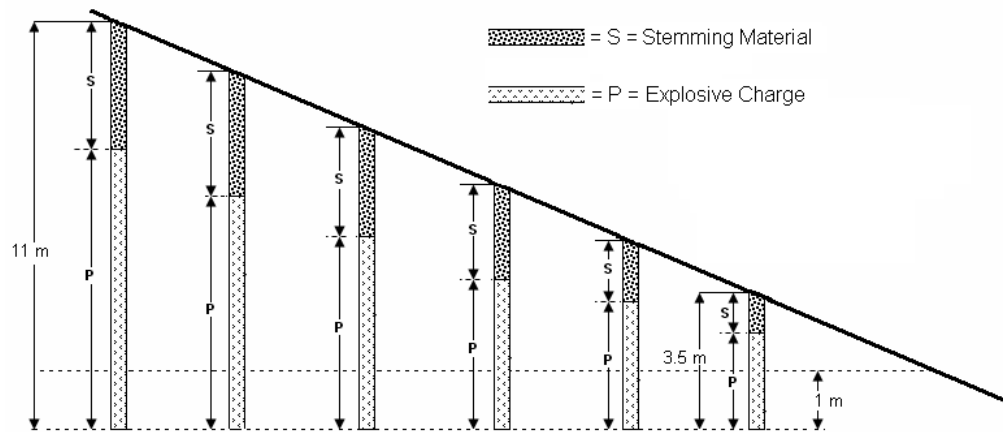

Figure 4.2 Charging pattern used to form a new bench at a natural slope

The diameters of production blast holes are varying as 152 mm (6 in), 158 mm (6 ¼ in) and 165 mm (6 ½ in) depending on the bit diameter. The major blasting agent used is ANFO. The density of ANFO is determined to vary between 0.72 gr/cm<sup>3</sup> and 0.80 gr/cm<sup>3</sup> depending on the batch. For this reason, depending on the hole diameter and the ANFO density, loading density varies between a minimum of 13 kg/m and a maximum of 18 kg/m. The burden distance for the holes in front row changes from 4.5 meters to 5.5 meters (Figure 4.3). The spacing distance between

the holes in a row varies from 5 meters to 6 meters. Accordingly, it is possible to say that the drilling pattern applied is 5 m x 5.5 m on average.

The explosive amount, for a short blast hole with a depth of 3.5 m, is determined to vary between 13 kg and 20 kg. The charge amount per blast hole, of 11 m depth, usually varies from 80 kg to 95 kg of ANFO. However, it is understood from the records that, the long blast holes are charged at 100 kg rarely, and at 110 kg at maximum. Once, 122 kg of ANFO is charged to a single hole of 11.4 m depth, by reducing the stemming length to 4 meters, to make a test shot.

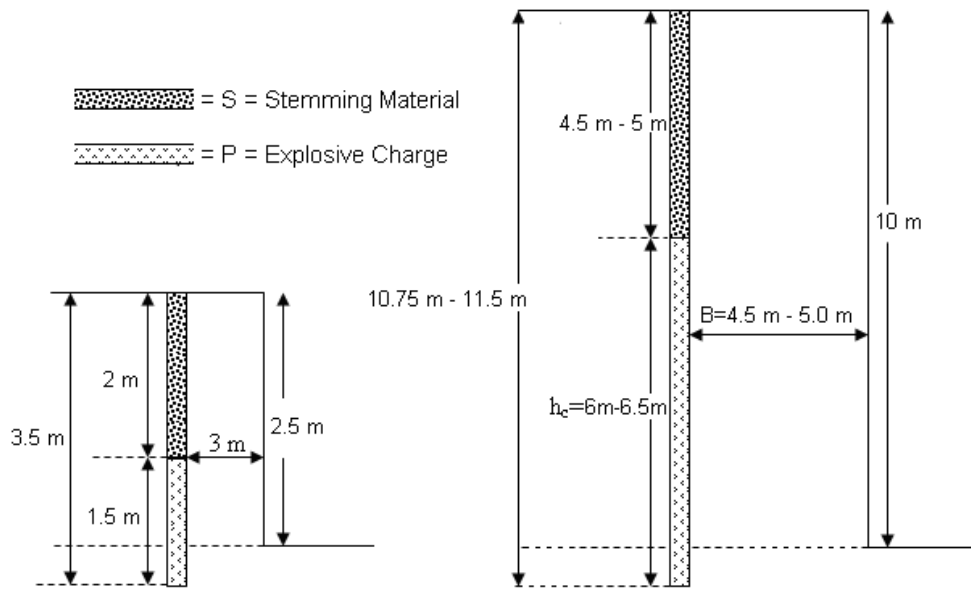

Figure 4.3 Explosive charging patterns for short and long blast holes

A cap sensitive emulsion explosive cartridge, weighing either 0.74 kg or 1 kg, is used as primer in each blast hole. Initiation of primers is done using nonelectric shock tube detonators. Each blast hole in a blast round detonates separately one after the other, since delay periods are applied within each row and in between the rows of holes. For this reason, the total number of blast holes in a blast round

doesn't have any importance. In another saying, the explosive amount to be taken into consideration from ground vibration point of view is the charge amount detonated per delay. Two types of delay firing patterns are used. In the first pattern, the delay periods are 25 ms (milliseconds) between successive holes in a row and 42 ms between the rows (Figure 4.4). In the second pattern, the delay periods used are 42 ms (milliseconds) in row, and 67 ms in between the rows (Figure 4.5). It is determined that the seismic waves are tried to be separated from each other and the super positioning of the waves are tried to be prevented, hence the control of ground vibration is provided in this way. The stemming is always employed at the collar of production blast holes (Figure 4.3), the occurrence of air blast waves are prevented. The stemming lengths practiced are not shorter than 2.0-2.5 meters in short holes, whereas not shorter than 4.0-4.5 meters in long blast holes. This blasting pattern is strictly employed and it is observed that the blasting operations are conducted according to technical and scientific principles in a strict discipline (Bilgin et. al., 2007).

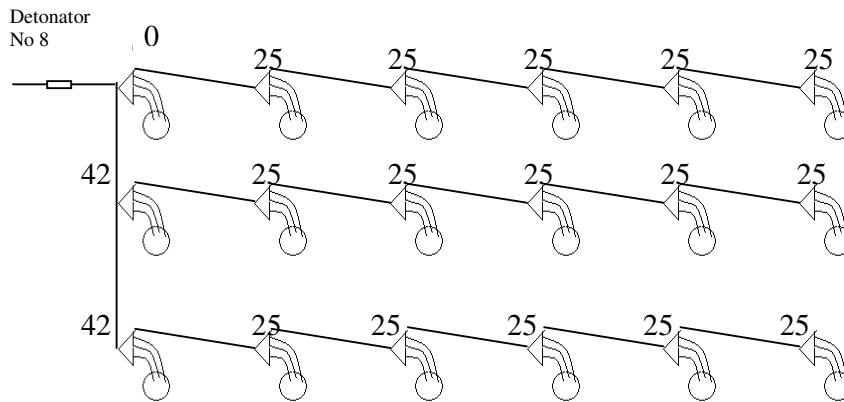

Figure 4.4 Initiation pattern using 25 ms in row and 42 ms inter row delay periods



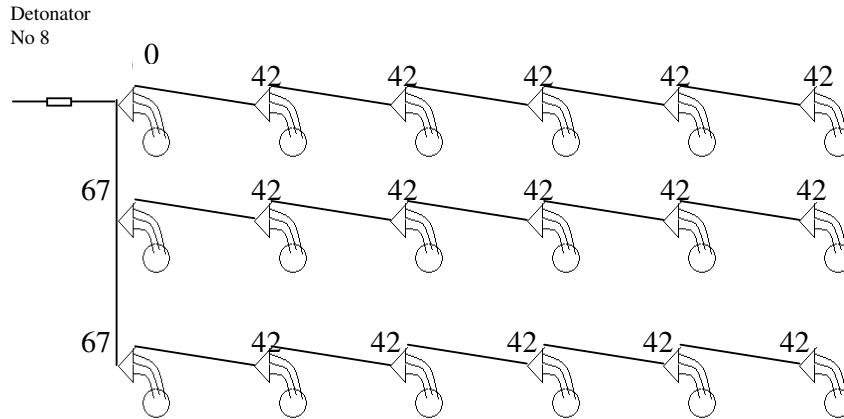

Figure 4.5 Initiation pattern using 42 ms in row and 67 ms inter row delay period

### 4.3. Structural Features of the Buildings

The probability of structural damage occurrence due to ground vibration induced by blasting depends on the technical features of the buildings as well as the characteristics of blasts. In other words, the vibration levels that a building can tolerate without experiencing damage vary depending on its technical features. For this reason, the buildings are inspected in terms of their technical conditions by visiting the nearest inhabited areas at the beginning of research work. The settlements visited are Gümüşkol Village, its Micanlar District and Karapınar and Katrancılar Districts.

The structures at the settlements are one or two story residential buildings. Most of them are constructed of rubble stone using clay mortar with a few exceptions (Figure 4.6, Figure 4.7, and Figure 4.8). Dressed stones are used at the corners of some buildings (Figures 4.6, 4.7, 4.8). Some of the buildings are hybrid structures since dressed and undressed stones and solid bricks are used together (Figures 4.7, 4.8). Close in view of clay mortar and rubble stone wall is given in Figure 4.9. Clay mortar is a material with no tensile strength. To avoid this drawback, continuous wooden courses are generally used at the walls to form framed structure so that the building can be reinforced against the earthquakes, the ground or foundation

settlements. However, almost no wooden courses are observed at the walls of structures in the settlements investigated. Wooden courses are used above the walls only to make wooden ceilings in single or two story buildings (Figures 4.6, 4.8). Since buildings have got walls with no tensile strength, this fact is taken into consideration during ground vibration evaluation and determination of allowable vibration level (Bilgin et. al., 2007).

Damages, not induced by blasts, in the form of cracks formed previously due to ground settlement, weak foundation or water penetration to foundation are observed in conjunction with absence of wooden courses at walls (Figures 4.7, 4.10).

A few numbers of lime mortared, cellular brick walled and/or reinforced concrete structures are also observed besides clay mortared rubble stone buildings (Figure 4.11). These structures are not engineered but built by local bricklayers. A single story building with cellular brick walls, reinforced roof slab and reinforced lintels above windows is shown in Figure 4.12. However, it is determined that the brick walls and the foundation walls are laid using clay mortar. In spite of the reinforced concrete roof slab, the building will suffer from damage due to a possible deformation in the clay mortared foundation wall, since clay mortar has got no tensile strength.

Two story buildings may have cellular brick walls at first floor, even if they have clay mortared rubble stone foundation and ground floor walls (Figure 4.13). Even if lime mortar is used in the first floor walls, these walls suffer from damage due to a possible damage in clay mortared ground floor wall (Figure 4.14). A vertical crack formed at intersection of first floor walls is shown in Figure 4.14. The wall at left is an interior wall, whereas the wall at right is an exterior wall (Figure 4.14). Someone, who is not an expert, may conclude at first look that this crack is formed due to blast induced ground vibration at the intersection of the walls. But this is not true (hatchure is the evidence). The crack at the intersection of walls is formed due both to shear movement (shear stress) of interior wall which is resting on the

deflecting wooden floor slab (Figure 4.15) and the settlement of exterior wall. A drawing explaining this mechanism is given in Figure 4.16 with the code MODEL NVSC (Bilgin et. al., 2007).

Another vertical crack is observed at the upper right corner of Figure 4.14, which has descending closure and finally disappearing. This fact proves that vertical crack is formed as a result of tensile stress acting within the plane of wall due to downward deflection of opposite foundation corners. A drawing explaining the mechanism of normal vertical tension crack is given in Figure 4.16 with a code MODEL NVTC-1.

The first storey floor is made of timber. Wooden floor rests on wood beams. But, although the ends of the beams rest on exterior walls, the central part of the beams are free to deflect downward since they have insufficient support. Besides, one of the main beams rest on interior door opening (door lintel) (Figure 4.15). For this reason, the main beam and hence first storey wood floor deflects seasonally and continuously. The interior wall, resting on first storey wood floor, is cracked for this reason. The other cause is the settlement of foundation corners of exterior wall. As it is explained in detail above, it is certainly understood that the cracks observed in this house are not formed due to ground vibration (seismic effects).



Figure 4.6 Clay mortared rubble stone building at Gümüşkol Village



Figure 4.7 Structure built with undressed stone and dressed stones at corners using clay mortar in 1945 at Katrancılar District



Figure 4.8 Clay mortared hybrid (undressed and dressed stones and solid bricks) structure at Gümüşkol Village



Figure 4.9 Close in view of clay mortar at the bare wall of rubble stone building at Gümüşkol Village





Figure 4.10 The repaired tension cracks at the corner of the building formed previously due to differential ground settlement or weak foundation at Gümüşkol Village



Figure 4.11 Different structure types at Gümüşkol Village; rubble stone building with clay mortar at right, lime mortared solid/cellular brick walled and reinforced but not engineered structures at the middle and left



Figure 4.12 Hybrid structure at Gümüşkol Village (rubble stone foundation and cellular brick wall are laid using clay mortar, lintel above window and roof slab are reinforced concrete)



Figure 4.13 Two story hybrid structure at Micanlar District (rubble stone wall at ground floor and cellular brick wall at first floor are laid using clay mortar, lintels above windows are reinforced concrete)



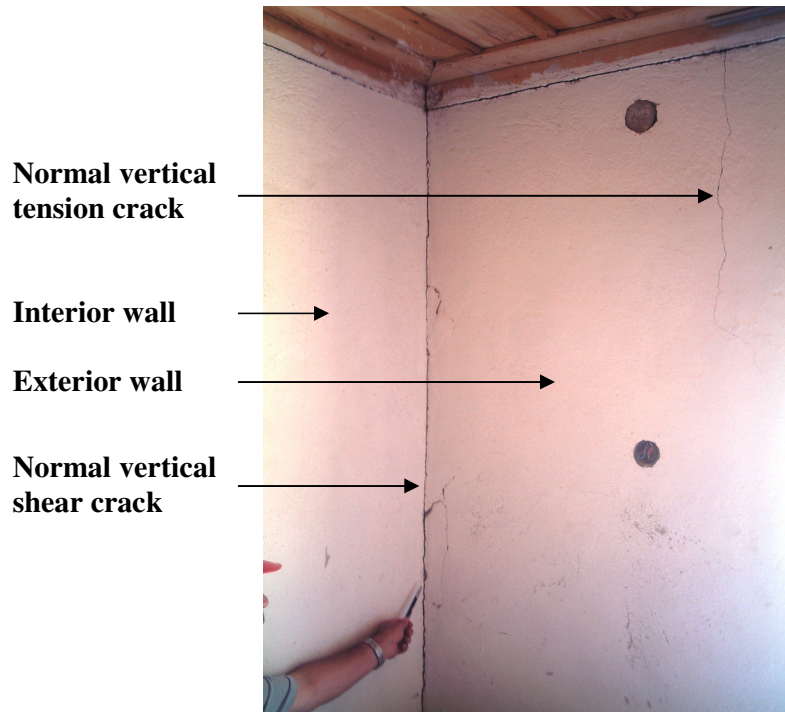

Figure 4.14 House at Micanlar District (Normal vertical tension crack at exterior wall and normal vertical shear crack at the intersection of exterior and interior walls, note hatchures across the crack)



Figure 4.15 House at Micanlar District (deflection of wood beam, resting on interior door lintel instead of a column, contributed to the development of shear crack at the wall intersection in Figure 4.14)



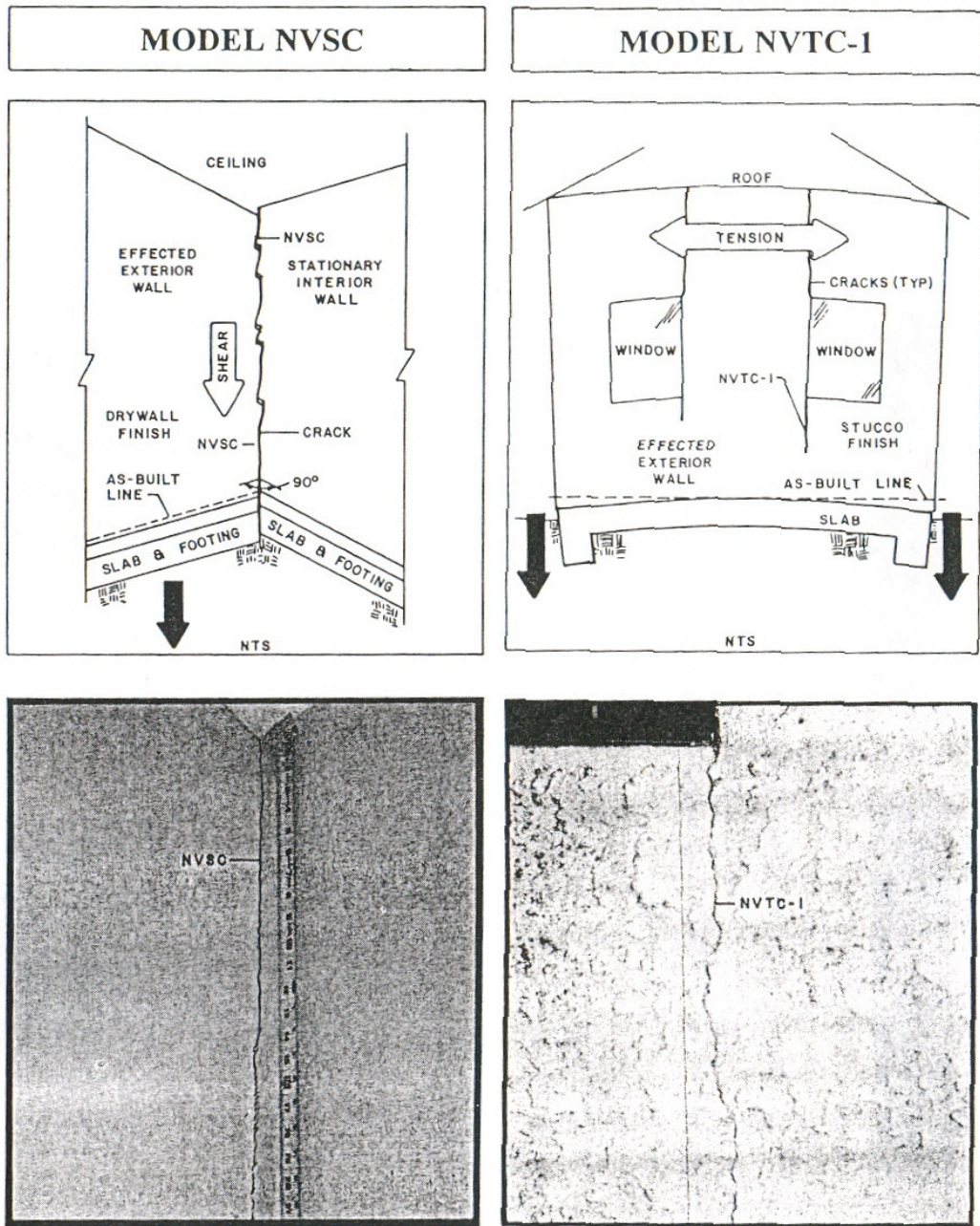

Figure 4.16 Crack patterns explaining the mechanism of formation of cracks observed at the first floor of house and given in Figure 4.14 (normal vertical tension crack at right, normal vertical shear crack at left, Audell, 1996)

#### 4.4. Monitoring Procedure

For determination of the coordinates of the holes and the monitoring stations a handheld GPS (Global Positioning System) instrument is used. The absolute distances between the boreholes and the monitoring stations are also calculated by GPS instrument.

For the monitoring of the ground vibration components White Mini-Seis II model and Instantel® Minimate® model digital vibration and overpressure monitoring seismographs are used. Instruments used in the study are shown in Figure 4.17 and Figure 4.18.

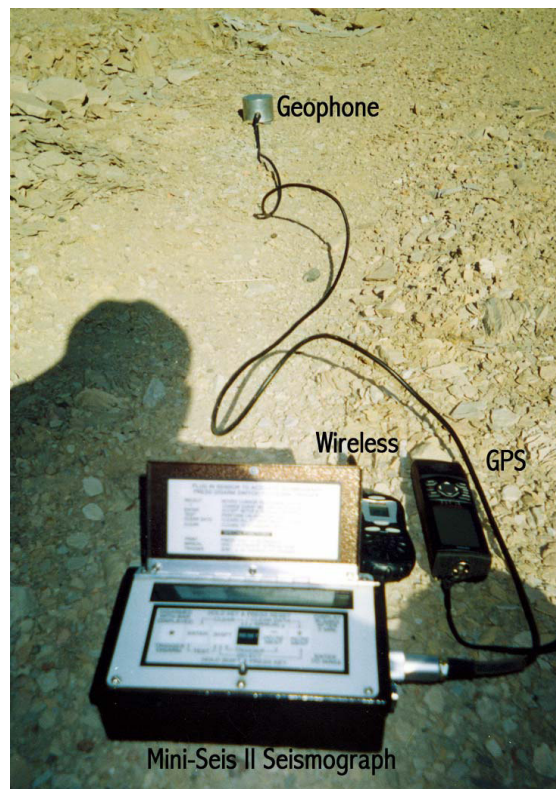

Figure 4.17 White Mini-Seis II model seismograph and GPS (Global Positioning System) instrument.



Figure 4.18 Instantel® Minimate® model seismograph.

#### 4.4.1. White Mini-Seis II model seismograph

The specifications of the White Mini-Seis II model seismograph are summarized below.

- 1- The model is portable seismograph for monitoring and recording seismic and sound signals produced from blasting.
- 2- It can be used for a single shot or a continuous mode.
- 3- It basically consists of three geophones (transversal, vertical and longitudinal) positioned perpendicular to one another in a steel body and an external microphone.
- 4- A microphone rated to at least 100 dB can be connected to the seismograph.
- 5- Mini-Seis II can record frequencies from 2 to 250 Hz.
- 6- The full waveform signature is stored in solid state memory for up to 341 events.

- 7- Seismic recording range selected is from 0.250 to 64 mm/sec.
- 8- With a full charged battery, the instrument will operate from 7 to 10 days.
- 9- Maximum record duration is 9 seconds; accuracy is  $\pm 1\%$  at 15 Hz.

The instrument records peak values of particle velocity in three directions, transverse, vertical and longitudinal (radial) as well as the time-histories of seismic vibrations. The seismograph also has its own data analysis software called “White Seismograph Data Analysis 2003”, which provides the easiest way to access and analyze recorded data. This program was installed in a portable computer brought to the mine site, so the recorded data could be downloaded to the computer and analyzed daily. An example of the waveform time-history of a blasting event is given in Figure 4.19.

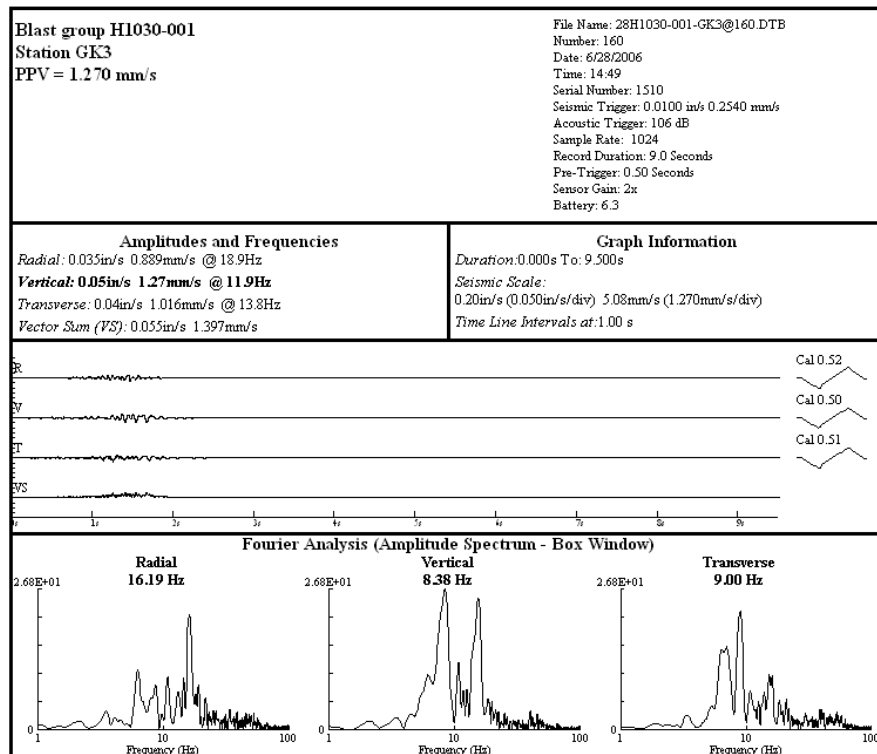

Figure 4.19 Waveforms of a round-blast event from data analysis software called “White Seismograph Data Analysis 2003”.

#### **4.4.2. InstanTel® Minimate® model seismograph**

The specifications of the InstanTel® Minimate® model seismograph are summarized below.

1. The model is portable seismograph for monitoring and recording seismic and sound signals produced from blasting.
2. It basically consists of three geophones (transversal, vertical and longitudinal) positioned perpendicular to one another in a steel body and an external microphone.
3. There are three record modes; Manual, Single-shot, Continuous.
4. Seismic trigger range selected is from 0.25 to 127 mm/s (0.01 to 5 in/s)
5. Acoustic trigger range selected is from 106 to 148 dB
6. Record time ranges from 1 to 10 seconds (programmable in one-second steps)
7. Battery is rechargeable 6V sealed gel cell - capacity for 240 hours continuous monitoring.
8. Auto-record time is auto window programmable from 1 to 9 seconds, plus a 0.25 second pre-trigger. Event is recorded until activity remains below trigger level for duration of auto window, or until available memory is filled.
9. The full waveform signature is stored in solid state memory for up to 40 events.
10. Accuracy is  $\pm 1\%$  at 15 Hz whereas the resolution is 0.125 mm/s.

The instrument records peak values of particle velocity in three directions, transverse, vertical and longitudinal (radial) as well as the time-histories of seismic vibrations. Recorded events are easily downloaded to a computer via a standard RS-232 interface using the InstanTel Blastware® Compliance Module software. Blastware software also provides the tools you need to manage event files, with the ability to print both event reports and FFT frequency analysis. This program was installed in a portable computer brought to the mine site, so the recorded data could be downloaded to the computer and analyzed daily. An example of the waveform time-history of a blasting event is given in Figure 4.20.

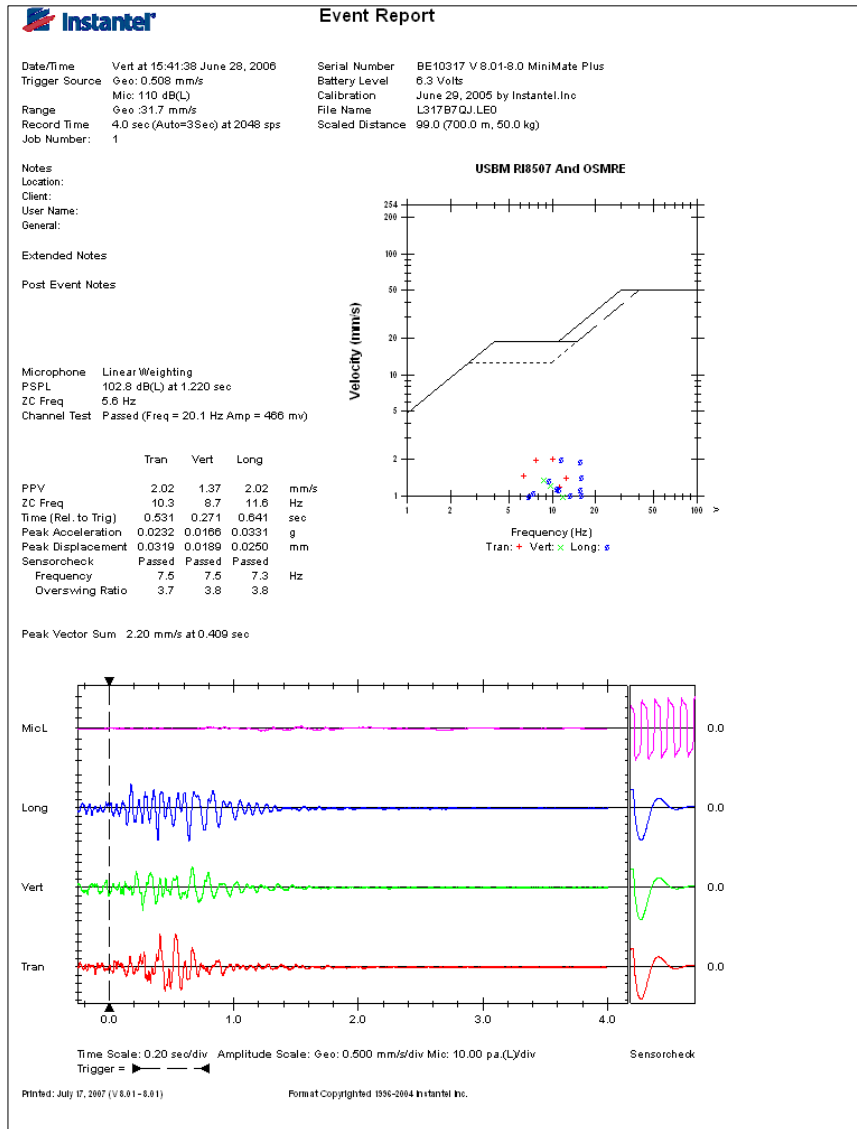

Figure 4.20 Waveforms of a round-blast event from data analysis software called “Instantel Blastware® Compliance Module software”.

The blasting geometry applied in the mine and the charging process was designed by blasters from the company, and the vibration measurements were applied to this blasting geometry. In other words, the blasting pattern (borehole length, spacing and burden) as well as the amount of charge to be fired at the same delay period, were the only data obtained from the blast site, which would be the basis of monitoring.

## CHAPTER 5

### RESULTS AND DISCUSSIONS

#### 5.1. Monitoring Paths

##### 5.1.1. Gümüşkol Village Path

The position of final pit boundary, the locations of monitoring stations along Gümüşkol Village path, and that of production and presplit blasting operations conducted at the mine, during which the monitoring and recording of ground vibration is made, are shown in Figure 5.1.

In Figure 5.1, the closed red line in zig zag form shows the final pit boundary. Within the final pit boundary, red colored star symbols indicate the locations of the production blast rounds, whereas blue colored small circles represent the locations of the presplit blast groups. The locations of monitoring stations are marked by yellow small squares with red colored boundaries. The codes of monitoring stations are written in black beside the small squares. The buildings at Gümüşkol Village (GK) and its Micanlar District (MC), which are closest to the mine, are represented by green colored star symbols and their codes are written beside each star symbol in green as GK-EYE and MC-EYE. The monitoring station, which is nearest to the settlement and coded GK-10, is located at 335 meters from MC-EYE and at 404 meters from GK-EYE towards the mine. The monitoring station coded GK-10 is 1109 meters distant from the final pit boundary.



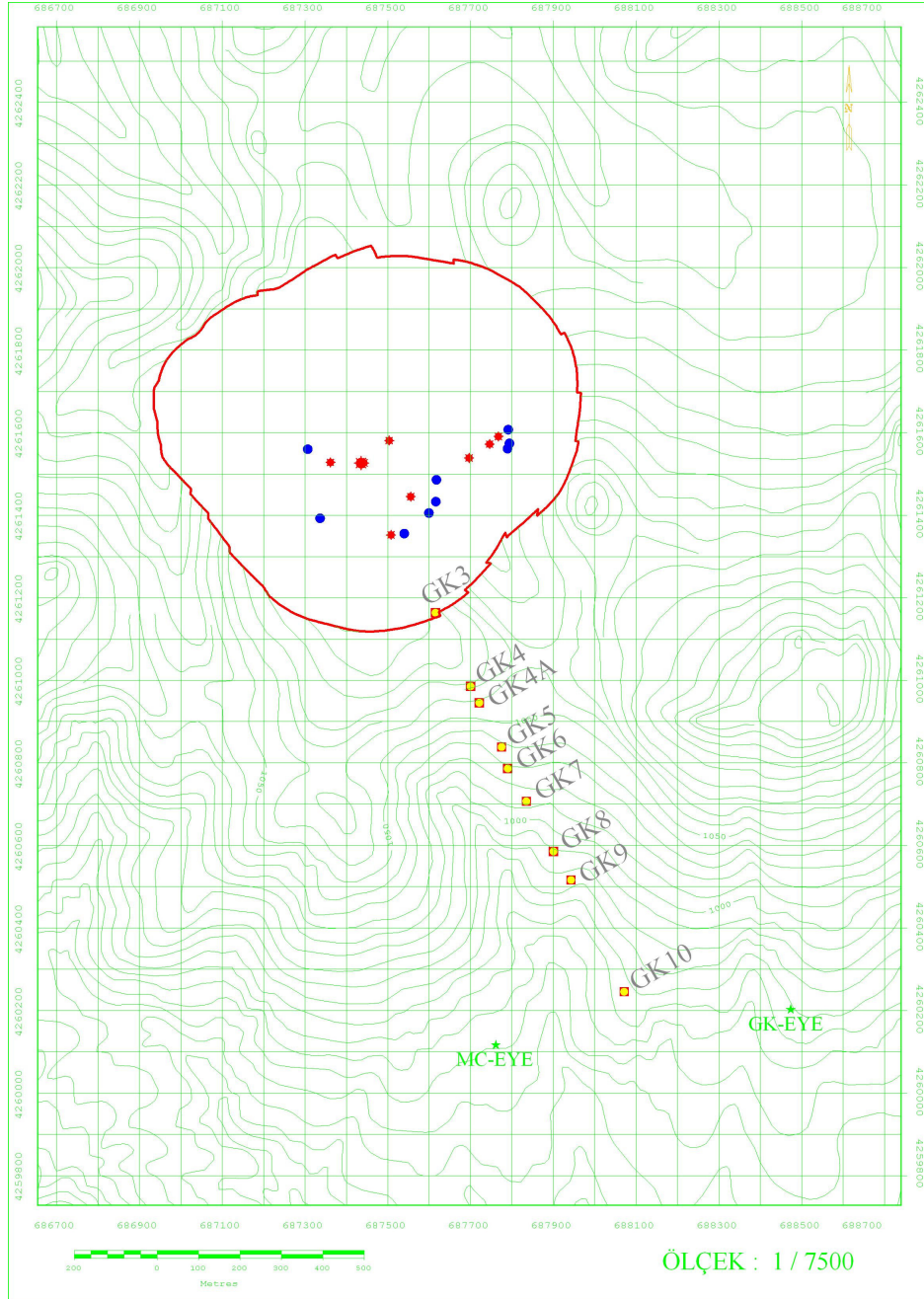

Figure 5.1 Monitoring stations along Gümüşkol Village path



### 5.1.2. Katrancilar District Path

The position of final pit boundary, the locations of monitoring stations along Katrancilar District path, and that of production and presplit blasting operations conducted at the mine, during which the monitoring and recording of ground vibration is made, are shown in Figure 5.2.

In Figure 5.2, the closed red line in zig zag form shows the final pit boundary. Within the final pit boundary, red colored star symbols indicate the locations of the production blast rounds, whereas blue colored small circles represent the locations of the presplit blast groups. The locations of monitoring stations are marked by yellow small squares with blue colored boundaries. The codes of monitoring stations are written in black beside the small squares. The building (haymow) closest to the mine at Katrancilar District (KT) is represented by green colored star symbol and its code is written beside the star symbol in green as KT-EYE. Monitoring station coded KT-4A, which is located 39 meters north of KT-EYE, is 1258 meters distant to the final pit boundary. Actually, KT-4A is in the same line with the closest dwelling. Thus, the nearest building (haymow) coded KT-EYE is 1220 meters and the nearest dwelling is 1258 meters distant to the final pit boundary.

Sogutlu Village is located at north of Katrancilar District (far back from the mine) and is 3515 meters distant from the final pit boundary and is approximately in the same direction with respect to the mine. For this reason, there is left no necessity to carry out monitoring for Sogutlu Village. Two valid reasons are:

- a. Both settlements are approximately on the same line and the ground characteristics, in which the seismic waves will propagate, are the same. Therefore, the empirical law to be determined for wave propagation and attenuation will be valid for both settlements.
- b. If the blasting operations conducted doesn't carry any risk for structural damage at Katrancilar District, which is 1220 meters distant to the final pit

boundary, there will be no damage risk at Sogutlu Village at all, which is 3515 meters distant to the mine.

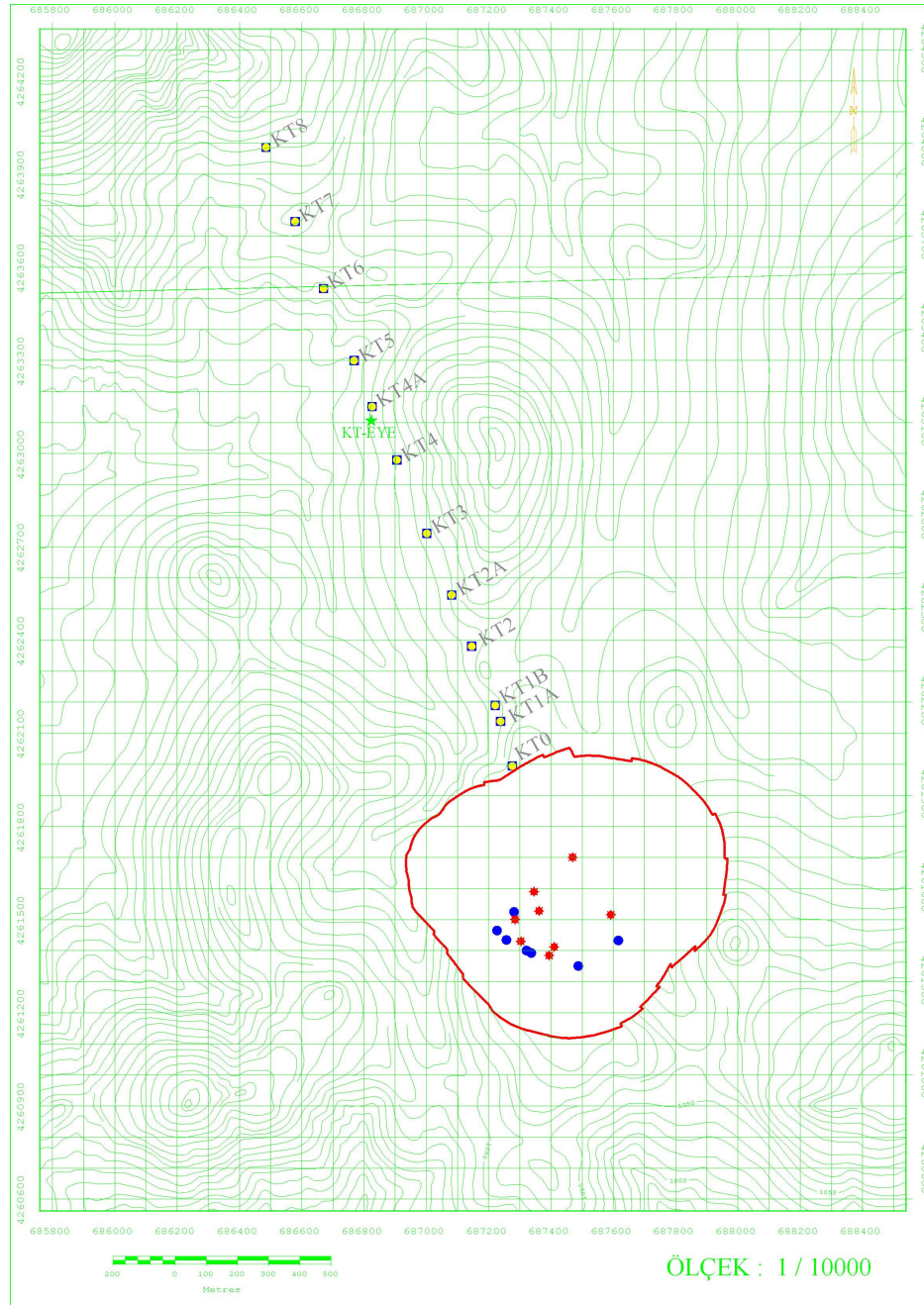

Figure 5.2 Monitoring stations along Katrancilar District path

### 5.1.3. Karapınar District Path

The position of final pit boundary, the locations of monitoring stations along Karapınar District path, and that of production and presplit blasting operations conducted at the mine, during which the monitoring and recording of ground vibration is made, are shown in Figure 5.3.

In Figure 5.3, the closed red line in zig zag form shows the final pit boundary. Within the final pit boundary, red colored star symbols indicate the locations of the production blast rounds, whereas blue colored small circles represent the locations of the presplit blast groups. The locations of monitoring stations are marked by yellow small squares with blue colored boundaries. The codes of monitoring stations are written in black beside the small squares. The building (dwelling) closest to the mine at Karapınar District (KR) is represented by green colored star symbol and its code is written beside the star symbol in green as KR-EYE. Monitoring station coded KR-10 is located near to the corner of the building (KR-EYE) closest to the mine at Karapınar District. Monitoring station KR-10 is 1402 meters distant to the final pit boundary.

Bekisli Village is located at northwest of Karapınar District (far back from the mine) and is 3037 meters distant from the final pit boundary and is approximately in the same direction with respect to the mine. For this reason, there is left no necessity to carry out monitoring for Bekisli Village. Two valid reasons are:

- a. Both settlements are approximately on the same line and the ground characteristics, in which the seismic waves will propagate, are the same. Therefore, the empirical law to be determined for wave propagation and attenuation will be valid for both settlements.
- b. If the blasting operations conducted doesn't carry any risk for structural damage at Karapınar District, which is 1402 meters distant to the final pit boundary, there

will be no damage risk at Bekisli Village at all, which is 3037 meters distant to the mine.

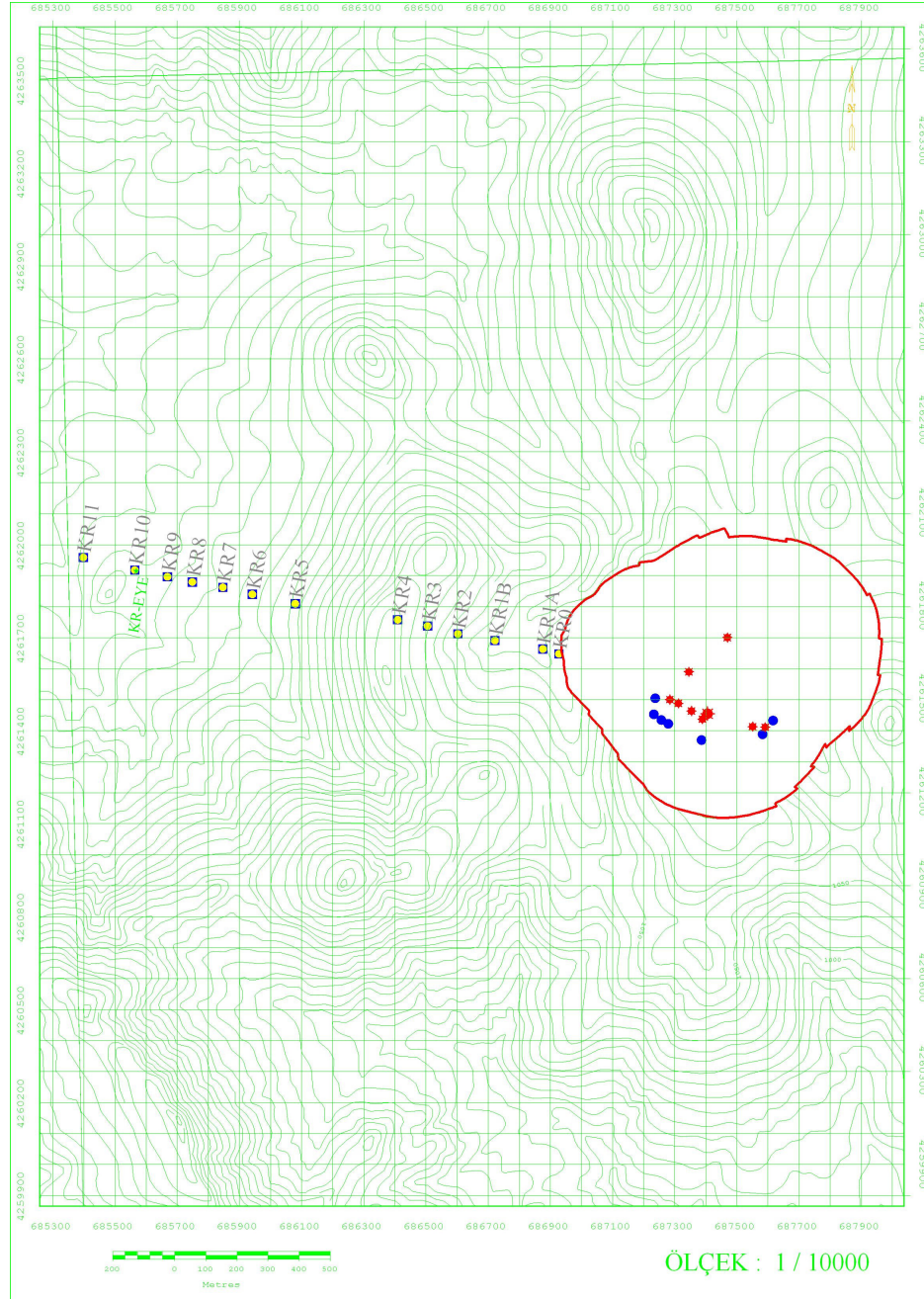

Figure 5.3 Monitoring stations along Karapınar District path

## 5.2. Records Taken Along Gümüşkol Village Path

The recorded values of ground vibration are presented in Table 5.1 while monitoring along Gümüşkol Village path during the blasting operations conducted at Kışladağ Gold Mine by TÜPRAG Metal Madencilik Sanayi ve Ticaret Ltd. Sti. In table; device no, monitoring station code, recorded particle velocities for longitudinal (R), vertical (V), and transverse (T) components, vector sum velocity (VS), peak particle velocity (PPV), charge amount per delay (Q), distance between monitoring station and blast hole having the maximum charge per delay (D) and scaled distance (SD) calculated are given. Particle velocity components are described as follows: Particle motion, due to a propagating seismic wave in the ground, occurring back and forth is called longitudinal component (R), whereas occurring up and down is called vertical component (V). Similarly motion of a particle in the ground occurring sidewise is called transverse component (T). The resultant of three components of motion is called vector sum (VS) velocity. Table 5.1 includes the dominant frequencies of seismic waves, calculated by Fast Fourier Transform technique (FFT), for longitudinal (R, Hz), vertical (V, Hz) and transverse (T, Hz) components also. In addition, blast round codes together with date and time are given in Table 5.1. Event reports of blast rounds taken for Gümüşkol Village path from data analysis soft wares “White Seismograph Data Analysis 2003” and “Instanet Blastware® Compliance Module software” are presented in Appendix A.

Scaled distance-particle velocity graphs drawn by using the data given in Table 5.1 for Gümüşkol Village path are presented in Appendix B. In graphs, the straight line below represents 50 % confidence, whereas above represents 95 % confidence. The equations given beside the straight lines are attenuation equations for seismic waves. Distance-maximum allowable charge table is prepared using PPV equation for 95 % confidence (Table 5.2). Distance-maximum allowable charge table is used for determining the safe explosive amount to be detonated per delay in case the distance between the shot location and the structure, which is not to be damaged

even at threshold level, is measured and known. Distance-maximum allowable charge table given in this section is valid only for Gümüşkol Village path and should not be used to determine safe charge amount for any other path, since the ground conditions and accordingly the propagation and attenuation characteristics are different for another path.

### **5.2.1. Evaluation of Vibration Velocities Recorded Along Gümüşkol Village Path**

The shortest distance between final pit boundary and Gümüşkol Village is measured as 1109 meters. However, the blasts are conducted at the middle of the pit at present and the pit has not reached its final boundary yet. For this reason, the blasts are realized at 1200 to 1465 meters distances to Gümüşkol Village. The highest particle velocities monitored are recorded at monitoring station GK3 located 11 m inside the final pit boundary as 8.48 mm/s and 8.03 mm/s at 217 m and 287.4 m distances from shot locations respectively. Excluding the above given highest values, vibration velocities are in the range of 0.5 to 2.9 mm/s in general. The lowest particle velocity is recorded as 0.25 mm/s at monitoring station GK10 located 95 m away from Gümüşkol Village towards the mine. US Federal Regulation, (Table 2.2); permits vibration velocities up to 25.40 mm/s for blasts conducted at 92-1524 m distances, whereas Turkish Regulation gives the limiting value as 19 mm/s for the frequency range of 4-10 Hz. Accordingly, all the blasts made are in accordance with Turkish and US Regulations and obey the scientific and technical rules. All of the vibration velocities recorded complies with the limit of 12.7 mm/s given in Table 2.1 for older houses in USBM (1980) criteria.

Table 5.1 Ground vibrations recorded along Gümüşkol Village path

Device No	Station Code	Particle Velocity (mm/s)					Charge Q (kg)	Distance D (m)	Scaled Distance SD ( $kg/\sqrt{m}$ )	Dominant Frequency (Hz)			Blast Round No	Time	Date
		R	V	T	VS	PPV				R	V	T			
316	GK3	2.320	2.190	1.620	2.490	2.320	88.97	404.38	42.87	6.38	9.00	11.90	1030-001-145	15:40:24	28-Jun-06
317	GK4	2.020	1.370	2.020	2.200	2.020	88.97	601.79	63.80	16.00	8.75	6.88		15:41:38	
W-160	GK5	0.889	1.270	1.016	1.397	1.270	88.97	766.69	81.28	16.19	8.38	9.00		14:49:00	
317	GK3	8.410	5.920	8.480	8.990	8.480	88.56	216.81	23.04	23.10	37.40	44.80	1040-020-076	15:44:12	29-Jun-06
316	GK4A	2.210	1.900	2.520	2.900	2.520	88.56	458.89	48.76	15.10	23.00	23.00		15:44:11	
W-161	GK-6	1.397	1.524	2.540	2.540	2.540	88.56	632.02	67.16	23.19	17.75	13.25		15:42:00	
317	GK5	0.794	0.714	0.889	1.010	0.889	59.93	704.37	90.99	32.50	14.00	11.00	1010-005-135	16:11:26	03-Jul-06
316	GK6	0.730	0.508	0.746	0.774	0.746	59.93	757.84	97.89	14.30	14.30	11.00		16:11:16	
W-165	GK7	0.508	0.381	0.381	0.508	0.508	59.93	842.77	108.86	22.50	23.06	22.69		16:09:00	
317	GK5	1.510	0.952	1.650	1.770	1.650	94.70	763.99	78.51	11.40	15.80	10.90	1030-002-129	16:41:10	06-Jul-06
W-170	GK9	0.889	0.635	0.762	1.016	0.889	94.70	1126.91	115.80	14.06	8.50	16.63		16:40:00	
317	GK4	1.700	2.030	1.570	2.170	2.030	99.18	588.52	59.09	14.10	22.60	9.88	1010-007-113	16:15:09	07-Jul-06
316	GK5	1.560	1.240	1.170	1.650	1.560	99.18	734.18	73.72	21.30	22.60	12.60		16:06:56	
W-173	GK8	0.508	0.508	0.635	0.635	0.635	99.18	998.39	100.25	12.88	12.69	23.19	16:14:00		
317	GK3	2.600	2.170	1.860	3.210	2.600	86.55	431.68	46.40	10.90	10.80	14.60	1010-009-166	15:09:48	11-Jul-06
316	GK4	1.810	1.830	1.830	2.140	1.830	86.55	626.87	67.38	9.75	11.10	11.10		15:01:27	
317	GK3	8.030	6.180	7.220	8.250	8.030	90.32	287.44	30.25	23.60	23.40	23.90	1030-003-130	15:25:07	13-Jul-06
316	GK4	2.860	4.600	4.750	5.330	4.750	90.32	481.66	50.68	23.40	24.10	19.90		15:24:04	
W-174	GK5	2.794	2.786	2.921	3.429	2.921	90.32	644.86	67.85	23.19	23.94	23.44		15:23:00	
317	GK4	2.000	1.640	2.290	2.390	2.290	96.71	608.81	61.91	16.60	22.30	8.88	1010-008-040	16:54:27	14-Jul-06
316	GK4A	1.710	1.210	1.600	1.870	1.710	96.71	646.36	65.73	27.50	19.10	24.40		16:54:27	
W-175	GK5	1.524	1.143	1.347	2.032	1.524	96.71	752.01	76.47	18.69	23.94	18.06		16:54:00	
W-010	GK10	0.254	0.127	0.254	0.254	0.254	90.73	1465.14	153.82	27.06	30.69	15.69	1030-012-063	16:17:00	08-Aug-06

Vibration velocity of 0.25 mm/s, recorded at monitoring station nearest to Gümüşkol Village (GK10), is equal to one seventy fifth (1.33 percent) of the limit of 19 mm/s set in Turkish Regulation. 0.25 mm/s vibration velocity measured is equal to 1 percent of the limit (25.40 mm/s) given in US Federal Regulation, whereas it is equal to 2 percent of the limit (12.7 mm/s) given for older houses in USBM (1980) criteria. It is also equal to one twelfth of the limit of 3 mm/s set in German DIN 4150 standard for buildings particularly sensitive (under preservation order such as ruins, ancient and historic buildings) to vibration. Accordingly, buildings in Gümüşkol Village are subjected to very low vibration levels that won't create any damage at all even in buildings under preservation order. For this reason, it is concluded that no damage occurred in the buildings at Gümüşkol Village due to blasting made at the mine.

Table 5.2 Maximum allowable charge amount per delay calculated for different distances and limiting PPV values for Gümüşkol Village path

<b>DISTANCE (m)</b>	<b>Maximum Allowable Charge Amounts (kg) per Delay for Selected Limiting PPV (mm/s) Values</b>			
	<b>3.00 mm/s</b>	<b>5.00 mm/s</b>	<b>12.70 mm/s</b>	<b>19.00 mm/s</b>
<b>500</b>	50.38	89.08	252.01	395.01
<b>600</b>	72.55	128.27	362.90	568.81
<b>700</b>	98.75	174.60	493.95	774.22
<b>800</b>	128.98	228.04	645.16	1011.22
<b>900</b>	163.24	288.62	816.53	1279.83
<b>1000</b>	201.53	356.32	1008.06	1580.03
<b>1100</b>	243.85	431.15	1219.75	1911.84
<b>1200</b>	290.20	513.10	1451.61	2275.25
<b>1300</b>	340.58	602.18	1703.62	2670.26
<b>1400</b>	395.00	698.39	1975.80	3096.87
<b>1500</b>	453.44	801.72	2268.13	3555.08
<b>1600</b>	515.91	912.18	2580.63	4044.89
<b>1700</b>	582.42	1029.76	2913.29	4566.30
<b>1800</b>	652.95	1154.47	3266.11	5119.31



Maximum allowable charge amounts per delay are calculated for various distances and different limit vibration values using the attenuation equation (Appendix B, Figure B.5) derived from the records taken along Gümüşkol Village path, and presented in Table 5.2. Assuming that the blasts will be carried out at the final pit boundary in the future, maximum allowable charge amount per delay is calculated as 243.85 kg for Gümüşkol Village, which is 1100 m distant to the final pit boundary, so that the vibration velocities will not exceed the limit (3 mm/s) set for buildings particularly sensitive to vibration (Table 5.2). During the studies, it is determined that a hole is charged at 80-95 kg's normally, at 100 kg's scarcely and 110 kg's at maximum and one hole detonates at a time. Accordingly, the charge amount detonated per delay at present, is less than the maximum allowable charge amount (110 kg < 243.85 kg) calculated for Gümüşkol Village (1100 m distant) and is technically appropriate .

### **5.2.2. Dominant Frequencies of Seismic Waves**

Dominant frequencies of seismic waves induced by blasts in the mine are determined by Fast Fourier Transform (FFT) technique as 6.38 Hz at minimum and 44.80 Hz at maximum. The dominant frequency is determined as 17.94 Hz on average by analyzing the seismic waves monitored along Gümüşkol path. In other saying, the dominant frequencies of seismic waves propagating in ground are greater than 10 Hz in 88 % of the cases. For this reason, it is concluded that there is no risk for structural damage (even at threshold level, such as cosmetic cracking in plaster).

The duration of the seismic waves is determined as 2.8 seconds from the records taken along Gümüşkol path. Thus, the lowest level of vibration velocity which may be perceived by humans is 1.78 mm/s for a seismic wave having 9 Hz frequency. On the other hand, the vibration velocities recorded at locations within 500 m distances to Gümüşkol Village are lower than 1 mm/s. Thus, it is impossible for

inhabitants to perceive the ground vibrations. Inhabitants probably suppose to be subjected to high vibration levels due to the noise they hear during presplit blasts. To completely eliminate the perception of inhabitants, the ground vibration level may be limited to 2 mm/s. However, it must be remembered that ANSI permits vibration levels up to 12.7 mm/s for 1 blast a day or up to 6.35 mm/s for 12 blasts a day for the humans in the buildings during day time (Table 2.6).

Considering the distance, which is 1109 meters, between Gümüşkol Village and the final pit boundary, charge amount per delay is calculated as 155.12 kg for PPV=2 mm/s to prevent the perception of inhabitants completely. But, a blast hole, having 165 mm diameter and 11 meters depth with a stemming length of 4.5 meters, can accommodate 110 kg of explosive at maximum. Thus, it is concluded that Gümüşkol Village inhabitants won't perceive the vibration at all or perceive it so slightly that they won't be disturbed, besides no structural damage, since 110 kg charge per delay is less than 155.12 kg and very much less than 243.85 kg.

Distances at which PPV falls to the selected different limiting PPV values for various charge amounts per delay for Gümüşkol Village path are calculated (Table 5.3). Thus, the ground vibration velocity decreases to 5 mm/s, 3 mm/s and 2 mm/s at distances of 555.62 m, 738.80 m and 926.31 m respectively, when a charge of 110 kg is loaded per hole and one hole is detonated at a time. Besides, the vibration velocity that is to be monitored at Gümüşkol Village will certainly be lower than 2 mm/s in any case, since Gümüşkol Village is 1109 m distant to the final pit boundary.

Table 5.3 Distances at which PPV falls to the selected different limiting PPV values for various charge amounts per delay for Gümüşkol Village path

EXPLOSIVE AMOUNT PER DELAY (kg)	Distances (m) Calculated for Selected Limiting PPV Values			
	3.00 mm/s	5.00 mm/s	12.70 mm/s	19.00 mm/s
50	498.10	374.60	222.71	177.89
60	545.64	410.35	243.97	194.87
70	589.36	443.23	263.52	210.48
80	630.05	473.83	281.71	225.02
90	668.27	502.58	298.80	238.66
100	704.42	529.76	314.96	251.57
110	738.80	555.62	330.33	263.85
120	771.65	580.32	345.02	275.59
130	803.16	604.02	359.11	286.84
140	833.48	626.82	372.67	297.67
150	862.73	648.82	385.75	308.11
160	891.03	670.10	398.40	318.22

### 5.3. Records Taken Along Karapınar District Path

The recorded values of ground vibration are presented in Table 5.4 while monitoring along Karapınar District path during the blasting operations conducted at Kışladağ Gold Mine by TÜPRAG Metal Madencilik Sanayi ve Ticaret Ltd. Sti. In table; device no, monitoring station code, recorded particle velocities for longitudinal (R), vertical (V), and transverse (T) components, vector sum velocity (VS), peak particle velocity (PPV), charge amount per delay (Q), distance between monitoring station and blast hole having the maximum charge per delay (D) and scaled distance (SD) calculated are given. Particle velocity components are described as follows: Particle motion, due to a propagating seismic wave in the ground, occurring back and forth is called longitudinal component (R), whereas

occurring up and down is called vertical component (V). Similarly motion of a particle in the ground occurring sidewise is called transverse component (T). The resultant of three components of motion is called vector sum (VS) velocity. Table 5.4 includes the dominant frequencies of seismic waves, calculated by Fourier Transform Technique (FTT), for longitudinal (R, Hz), vertical (V, Hz) and transverse (T, Hz) components also. In addition, blast round codes together with date and time are given in Table 5.4. Event reports of blast rounds taken for Karapınar Village path from data analysis soft wares “White Seismograph Data Analysis 2003” and “InstanTel Blastware® Compliance Module software” are presented in Appendix C.

Scaled distance-particle velocity graphs drawn by using the data given in Table 5.4 for Karapınar District path are presented in Appendix D. In graphs, the straight line below represents 50 % confidence, whereas above represents 95 % confidence. The equations given beside the straight lines are attenuation equations for seismic waves. Distance-maximum allowable charge table is prepared using PPV equation for 95 % confidence (Table 5.5). Distance-maximum allowable charge table is used for determining the safe explosive amount to be detonated per delay in case the distance between the shot location and the structure, which is not to be damaged even at threshold level, is measured and known. Distance-maximum allowable charge table given in this section is valid only for Karapınar District path and should not be used to determine safe charge amount for any other path, since the ground conditions and accordingly the propagation and attenuation characteristics are different for another path.

Table 5.4 Ground vibrations recorded along Karapınar District path

Device No	Station Code	Particle Velocity (mm/s)					Charge Q (kg)	Distance D (m)	Scaled Distance SD ( $kg/\sqrt{m}$ )	Dominant Frequency (Hz)			Blast Round No	Time	Date
		R	V	T	VS	PPV				R	V	T			
W-178	KR10	0.381	0.127	0.381	0.508	0.381	98.16	2090.11	210.96	8.88	8.56	9.69	1030-004-182	15:40:00	18-Jul-06
W-184	KR10	0.254	0.254	0.381	0.508	0.381	90.98	2050.37	214.96	12.56	12.94	9.13	1030-005-028	16:30:00	21-Jul-06
317	KR2	1.320	0.921	1.370	1.600	1.370	89.64	843.30	89.07	18.00	18.80	20.00	1030-006-069	16:11:23	25-Jul-06
316	KR4	0.571	0.508	0.714	0.716	0.714	89.64	1041.75	110.03	18.50	25.30	15.00		16:11:02	
W-188	KR8	0.254	0.127	0.254	0.254	0.254	89.64	1710.92	180.71	27.13	25.50	9.38		16:12:00	
317	KR3	0.730	0.667	0.873	0.910	0.873	97.09	933.40	94.73	25.00	35.00	21.50	1030-007-064	16:09:49	28-Jul-06
316	KR4	0.460	0.429	0.714	0.815	0.714	97.09	1031.23	104.66	35.00	9.75	25.00		16:09:22	
W-193	KR7	0.127	0.254	0.254	0.254	0.254	97.09	1599.91	162.37	9.44	25.00	9.63	16:10:00		
317	KR2	1.970	1.140	1.430	2.000	1.970	100.00	791.22	79.12	15.10	8.75	17.60	1030-013-079	16:39:07	31-Jul-06
316	KR6	0.349	0.270	0.714	0.750	0.714	100.00	1461.59	146.16	15.30	6.25	7.25		16:38:34	
W-195	KR7	0.254	0.381	0.254	0.381	0.381	100.00	1558.94	155.89	15.19	15.31	6.94		16:40:00	
316	KR6	0.460	0.286	0.556	0.614	0.556	95.00	1414.92	145.17	10.50	6.25	7.25	1030-014-118	17:39:09	01-Aug-06
W-200	KR8	0.254	0.254	0.381	0.381	0.381	95.00	1611.87	165.37	16.19	8.38	9.00		17:41:00	
W-000	KR6	0.508	0.254	0.381	0.635	0.508	122.17	1522.44	137.74	9.94	7.63	9.31	1030-015-079	16:10:00	15-Aug-06
317	KR1A	1.020	1.000	0.841	1.150	1.020	80.00	475.39	53.10	23.90	12.30	13.90	1030-010-111	16:42:44	17-Aug-06
316	KR3	0.778	0.571	0.429	0.831	0.778	59.85	964.82	124.71	9.38	19.10	10.30	1010-010-202	18:05:21	18-Aug-06

### **5.3.1. Evaluation of Vibration Velocities Recorded Along Karapınar District Path**

The shortest distance between final pit boundary and Karapınar District is measured as 1402 meters. However, the blasts are conducted at the middle of the pit at present and the pit has not reached its final boundary yet. Thus, the blasts are realized at 1750 to 2090 meters distances to Karapınar District. The highest particle velocity monitored is recorded, at monitoring station KR2 which is 342.6 meters distant to the final pit boundary, as 1.97 mm/s at 791.2 meters distance from the shot location. The highest vibration velocity of 1.97 mm/s is lower than the allowable limit velocity of 3 mm/s set in DIN 4150 standard for structures particularly sensitive to vibration such as ruins, ancient and historic buildings. The lowest particle velocities are recorded as 0.381 mm/s between the station coded KR7 located 283.7 meters in front of Karapınar District towards the mine and Karapınar District itself (station coded KR10). US Federal Regulation, (Table 2.2); permits vibration velocities up to 25.40 mm/s for blasts conducted at 92-1524 m distances, whereas Turkish Regulation gives the limiting value as 19 mm/s for the frequency range of 4-10 Hz. Thus, all the blasts made are in accordance with Turkish and US Regulations and obey the scientific and technical rules. All of the vibration velocities recorded complies with the limit of 12.7 mm/s given in Table 2.1 for older houses in USBM (1980) criteria.

Vibration velocity of 0.381 mm/s, recorded at monitoring station nearest to Karapınar District (KR10), is equal to one fiftieth (2 percent) of the limit of 19 mm/s set in Turkish Regulation. 0.381 mm/s vibration velocity measured is equal to 1.5 percent of the limit (25.40 mm/s) given in US Federal Regulation, whereas it is equal to 3 percent of the limit (12.7 mm/s) given for older houses in USBM (1980) criteria. It is also equal to one seventh of the limit of 3 mm/s set in German DIN 4150 standard for structures particularly sensitive (under preservation order such as ruins, ancient and historic buildings) to vibration. Accordingly, buildings in

Karapınar District are subjected to very low vibration levels that won't create any damage at all even in buildings under preservation order. For this reason, it is concluded that no damage occurred in the buildings at Karapınar District due to blasting made at the mine.

Table 5.5 Maximum allowable charge amount per delay calculated for different distances and limiting PPV values for Karapınar District path

<b>DISTANCE (m)</b>	<b>Maximum Allowable Charge Amounts (kg) per Delay for Selected Limiting PPV Values</b>			
	<b>3.00 mm/s</b>	<b>5.00 mm/s</b>	<b>12.70 mm/s</b>	<b>19.00 mm/s</b>
<b>500</b>	62.46	140.33	614.72	1163.90
<b>600</b>	89.94	202.08	885.20	1676.02
<b>700</b>	122.42	275.05	1204.86	2281.25
<b>800</b>	159.90	359.25	1573.69	2979.59
<b>900</b>	202.37	454.67	1991.71	3771.04
<b>1000</b>	249.84	561.33	2458.90	4655.61
<b>1100</b>	302.31	679.21	2975.26	5633.28
<b>1200</b>	359.77	808.31	3540.81	6704.07
<b>1300</b>	422.23	948.64	4155.53	7867.97
<b>1400</b>	489.69	1100.20	4819.43	9124.99
<b>1500</b>	562.14	1262.99	5532.51	10475.11
<b>1600</b>	639.59	1437.00	6294.77	11918.35
<b>1700</b>	722.04	1622.24	7106.21	13454.70
<b>1800</b>	809.48	1818.70	7966.82	15084.16

Maximum allowable charge amounts per delay are calculated for various distances and different limit vibration values using the attenuation equation (Appendix D, Figure D.5) derived from the records taken along Karapınar District path, and presented in Table 5.5. Assuming that the blasts will be carried out at the final pit boundary in the future, maximum allowable charge amount per delay is calculated as 489.69 kg for Karapınar District, which is 1400 m distant to the final pit boundary, so that the vibration velocities will not exceed the limit of 3 mm/s set for

buildings particularly sensitive to vibration (Table 5.5). During the studies, it is determined that a hole is charged at 80-95 kg's normally, at 100 kg's scarcely and 110 kg's at maximum and one blast hole detonates at a time. Accordingly, the charge amount detonated per delay at present, is less than the maximum allowable charge amount ( $110 \text{ kg} < 489.69 \text{ kg}$ ) calculated for Karapınar District (1400 m distant) and is technically appropriate .

### **5.3.2. Dominant Frequencies of Seismic Waves**

Dominant frequencies of seismic waves induced by blasts in the mine are determined by Fast Fourier Transform (FFT) technique as 6.25 Hz at minimum and 35.00 Hz at maximum. The dominant frequency is determined as 14.91 Hz on average by analyzing the seismic waves monitored along Karapınar District path. In other saying, the dominant frequencies of seismic waves propagating in ground are greater than 10 Hz in 77 % of the cases. For this reason, it is concluded that there is no risk for structural damage (even at threshold level, such as cosmetic cracking in plaster).

The duration of the seismic waves is determined as 3.0 seconds from the records taken along Karapınar District path. Thus, the lowest level of vibration velocity which may be perceived by humans is 1.78 mm/s for a seismic wave having 9 Hz frequency. On the other hand, the vibration velocities recorded at locations within 284 m distances to Karapınar District are equal to or lower than 0.381 mm/s. Thus, it is impossible for inhabitants to perceive the ground vibrations. Inhabitants probably suppose to be subjected to high vibration levels due to the noise they hear during presplit blasts. To completely eliminate the perception of inhabitants, the ground vibration level may be limited to 2 mm/s. However, it must be remembered that ANSI permits vibration levels up to 12.7 mm/s for 1 blast a day or up to 6.35 mm/s for 12 blasts a day for the humans in the buildings during day time (Table 2.6).



The charge amount per delay is calculated as 257.56 kg for PPV=2 mm/s to prevent the perception of inhabitants completely for 1402 meters distance between Karapınar District and the final pit boundary. But, a blast hole, having 165 mm diameter and 11 meters depth with a stemming length of 4.5 meters, can accommodate only 110 kg of explosive at maximum. Thus, it is concluded that Karapınar District inhabitants won't perceive the vibration at all or perceive it so slightly that they won't be disturbed, as well as no damage will occur, since 110 kg charge per delay is less than 257.56 kg and very much less than 489.69 kg.

Table 5.6 Distances at which PPV falls to the selected different limiting PPV values for various charge amounts per delay for Karapınar District path

<b>EXPLOSIVE AMOUNT PER DELAY (kg)</b>	<b>Distances (m) Calculated for Selected Limiting PPV Values</b>			
	<b>3.00 mm/s</b>	<b>5.00 mm/s</b>	<b>12.70 mm/s</b>	<b>19.00 mm/s</b>
<b>50</b>	447.36	298.45	142.60	103.63
<b>60</b>	490.06	326.94	156.21	113.52
<b>70</b>	529.32	353.14	168.72	122.62
<b>80</b>	565.87	377.52	180.37	131.09
<b>90</b>	600.19	400.42	191.32	139.04
<b>100</b>	632.66	422.08	201.66	146.56
<b>110</b>	663.54	442.68	211.51	153.71
<b>120</b>	693.04	462.36	220.91	160.55
<b>130</b>	721.34	481.24	229.93	167.10
<b>140</b>	748.57	499.41	238.61	173.41
<b>150</b>	774.85	516.94	246.99	179.50
<b>160</b>	800.26	533.89	255.09	185.38

Distances at which PPV falls to the selected different limiting PPV values for various charge amounts per delay for Karapınar District path are calculated (Table 5.6). Thus, the ground vibration velocity decreases to 5 mm/s, 3 mm/s and 2 mm/s at distances of 442.68 m, 663.54 m and 914.93 m respectively, when a charge of 110 kg is loaded per hole and one hole is detonated at a time. Besides, the vibration

velocity, that is to be monitored at Karapınar District, will certainly be lower than 2 mm/s in any case, since Karapınar District is 1402 m distant to the final pit boundary.

#### **5.4. Records Taken Along Katrancılar District Path**

The recorded values of ground vibration are presented in Table 5.7 while monitoring along Katrancılar District path during the blasting operations conducted at Kışladağ Gold Mine by TÜPRAG Metal Madencilik Sanayi ve Ticaret Ltd. Sti. In table; device no, monitoring station code, recorded particle velocities for longitudinal (R), vertical (V), and transverse (T) components, vector sum velocity (VS), peak particle velocity (PPV), charge amount per delay (Q), distance between monitoring station and blast hole having the maximum charge per delay (D) and scaled distance (SD) calculated are given. Particle velocity components are described as follows: Particle motion, due to a propagating seismic wave in the ground, occurring back and forth is called longitudinal component (R), whereas occurring up and down is called vertical component (V). Similarly motion of a particle in the ground occurring sidewise is called transverse component (T). The resultant of three components of motion is called vector sum (VS) velocity. Table 5.7 includes the dominant frequencies of seismic waves, calculated by Fourier Transform Technique (FTT), for longitudinal (R, Hz), vertical (V, Hz) and transverse (T, Hz) components also. In addition, blast round codes together with date and time are given in Table 5.7. Event reports of blast rounds taken for Katrancılar Village path from data analysis soft wares “White Seismograph Data Analysis 2003” and “Instanet Blastware® Compliance Module software” are presented in Appendix E.

Scaled distance-particle velocity graphs drawn by using the data given in Table 5.7 for Katrancılar District path are presented in Appendix F. In graphs, the straight line below represents 50 % confidence, whereas above represents 95 % confidence. The

equations given beside the straight lines are attenuation equations for seismic waves. Distance-maximum allowable charge table is prepared using PPV equation for 95 % confidence (Table 5.8). Distance-maximum allowable charge table is used for determining the safe explosive amount to be detonated per delay in case the distance between the shot location and the structure, which is not to be damaged even at threshold level, is measured and known. Distance-maximum allowable charge table given in this section is valid only for Katrancilar District path and should not be used to determine safe charge amount for any other path, since the ground conditions and accordingly the propagation and attenuation characteristics are different for another path.

#### **5.4.1. Evaluation of Vibration Velocities Recorded Along Katrancilar District Path**

The shortest distance between final pit boundary and Katrancilar District is measured as 1220 meters. However, the blasts are conducted at the middle of the pit at present and the pit has not reached its final boundary yet. Thus, the blasts are realized at locations 1550 m to 1800 meters distant to Katrancilar District. The highest particle velocity monitored is recorded, at monitoring station KT1A which is 165.27 meters distant to the final pit boundary, as 3.048 mm/s at 769.36 meters distance from the shot location. The lowest particle velocities are recorded as 0.254 mm/s at the monitoring stations coded KT3 located 406 m in front of, and KT4 located 152 m in front of Katrancilar District. US Federal Regulation, (Table 2.2); permits vibration velocities up to 25.40 mm/s for blasts conducted at 92-1524 m distances, whereas Turkish Regulation gives the limiting value as 19 mm/s for the frequency range of 4-10 Hz. Thus, all the blasts made are in accordance with Turkish and US Regulations and obey the scientific and technical rules. All of the vibration velocities recorded complies with the limit of 12.7 mm/s given in Table 2.1 for older houses in USBM (1980) criteria.

Table 5.7 Ground vibrations recorded along Katrancılar District path

Device No	Station Code	Particle Velocity (mm/s)					Charge Q (kg)	Distance D (m)	Scaled Distance SD ( $kg/\sqrt{m}$ )	Dominant Frequency (Hz)			Blast Round No	Time	Date
		R	V	T	VS	PPV				R	V	T			
317	KT2	1.080	1.250	1.300	1.600	1.300	98.45	1003.39	101.13	24.40	9.50	22.00	1030-008-009	16:46:57	04-Aug-06
W-004	KT4	0.254	0.127	0.254	0.254	0.254	98.45	1647.08	166.00	14.06	22.63	22.88		16:48	
317	KT2	0.857	0.968	1.110	1.190	1.110	90.73	878.96	92.28	21.00	23.30	22.60	1030-012-063	16:15:03	08-Aug-06
316	KT2A	0.333	0.349	0.635	0.714	0.635	90.73	1062.21	111.52	8.75	5.00	22.30		16:14:14	
W-016	KT1A	3.048	1.397	2.032	3.302	3.048	98.24	769.36	77.62	14.06	22.63	22.88	1030-009-009	16:07	11-Aug-06
317	KT1B	1.080	0.794	0.921	1.180	1.080	98.24	823.43	83.08	27.50	24.80	24.50		16:04:54	
316	KT2A	0.571	0.349	0.460	0.580	0.571	98.24	1208.88	121.97	13.30	14.50	19.80		16:03:59	
316	KT3	0.619	0.508	0.857	0.890	0.857	122.17	1414.11	127.94	9.00	8.75	9.25	1030-015-079	16:06:29	15-Aug-06
316	KT1A	0.746	0.667	0.968	1.010	0.968	80.00	558.52	62.44	43.10	9.88	44.30	1030-010-111	16:41:36	17-Aug-06
W-002	KT3	0.127	0.127	0.254	0.254	0.254	80.00	1203.43	134.55	7.31	11.94	14.44		16:45:00	
317	KT1B	2.380	1.710	1.460	2.600	2.380	59.85	548.64	70.92	19.10	23.00	9.50	1010-010-202	18:06:31	18-Aug-06
W-007	KT3	0.508	0.508	0.508	0.635	0.508	59.85	1142.86	147.73	18.69	15.13	9.38		18:09:00	
317	KT1A	1.380	0.778	1.350	1.880	1.380	90.00	711.03	74.95	44.10	20.80	46.40	1030-017-012	16:41:35	22-Aug-06
316	KT1B	0.683	0.794	0.968	1.160	0.968	90.00	764.13	80.55	9.75	10.50	24.00		16:40:17	
W-024	KT3	0.254	0.127	0.254	0.254	0.254	90.00	1347.38	142.03	9.94	7.63	9.91		16:45	
316	KT2	0.651	0.460	0.524	0.817	0.651	100.74	972.72	96.91	7.63	12.00	27.90	1010-012-002	14:13:19	25-Aug-06
W-004	KT2A	0.254	0.254	0.508	0.508	0.508	100.74	1156.98	115.27	6.31	6.13	5.75		14:18	

Vibration velocities of 0.254 mm/s, recorded at monitoring stations near to (KT3, KT4) Katrancilar District, is equal to one seventy fifth (1.33 percent) of the limit of 19 mm/s set in Turkish Regulation. 0.254 mm/s vibration velocity measured is equal to 1 percent of the limit (25.40 mm/s) given in US Federal Regulation, whereas it is equal to 2 percent of the limit (12.7 mm/s) given for older houses in USBM (1980) criteria. It is also equal to one twelfth of the limit of 3 mm/s set in German DIN 4150 standard for structures particularly sensitive (under preservation order such as ruins, ancient and historic buildings) to vibration. Accordingly, buildings in Katrancilar District are subjected to very low vibration levels that won't create any damage at all even in buildings under preservation order. For this reason, it is concluded that no damage occurred in the buildings at Katrancilar District due to blasting made at the mine.

Table 5.8 Maximum allowable charge amount per delay calculated for different distances and limiting PPV values for Katrancilar District path

<b>DISTANCE (m)</b>	<b>Maximum Allowable Charge Amounts (kg) per Delay for Selected Limiting PPV Values</b>			
	<b>3.00 mm/s</b>	<b>5.00 mm/s</b>	<b>12.70 mm/s</b>	<b>19.00 mm/s</b>
<b>500</b>	43.50	71.68	178.32	264.39
<b>600</b>	62.64	103.22	256.78	380.72
<b>700</b>	85.27	140.50	349.51	518.20
<b>800</b>	111.37	183.51	456.50	676.83
<b>900</b>	140.95	232.25	577.76	856.62
<b>1000</b>	174.01	286.73	713.28	1057.55
<b>1100</b>	210.55	346.94	863.07	1279.64
<b>1200</b>	250.58	412.89	1027.12	1522.87
<b>1300</b>	294.08	484.57	1205.44	1787.26
<b>1400</b>	341.06	561.99	1398.03	2072.80
<b>1500</b>	391.53	645.14	1604.88	2379.49
<b>1600</b>	445.47	734.02	1826.00	2707.33
<b>1700</b>	502.89	828.64	2061.38	3056.32
<b>1800</b>	563.80	929.00	2311.03	3426.47

Maximum allowable charge amounts per delay are calculated for various distances and different limit vibration values using the attenuation equation (Appendix F, Figure F.5) derived from the records taken along Katrancılar District path, and presented in Table 5.8. Assuming that the blasts will be carried out at the final pit boundary in the future, maximum allowable charge amount per delay is calculated as 250.58 kg for Katrancılar District, which is 1220 m distant to the final pit boundary, so that the vibration velocities will not exceed the limit of 3 mm/s set for buildings particularly sensitive to vibration (Table 5.8). During the studies, it is determined that a hole is charged at 80-95 kg's normally, at 100 kg's scarcely and 110 kg's at maximum and one blast hole detonates at a time. Accordingly, the charge amount detonated per delay at present, is less than the maximum allowable charge amount (110 kg < 250.58 kg) calculated for Katrancılar District (1220 m distant) and is technically appropriate.

#### **5.4.2. Dominant Frequencies of Seismic Waves**

Dominant frequencies of seismic waves induced by blasts in the mine are determined by Fast Fourier Transform (FFT) technique as 5.00 Hz at minimum and 46.40 Hz at maximum. The dominant frequency is determined as 17.72 Hz on average by analyzing the seismic waves monitored along Katrancılar District path. In other saying, the dominant frequencies of seismic waves propagating in ground are greater than 10 Hz in 76 % of the cases. For this reason, it is concluded that there is no risk for structural damage (even at threshold level, such as cosmetic cracking in plaster).

The duration of the seismic waves is determined as 2.6 seconds from the records taken along Katrancılar District path. Thus, the lowest level of vibration velocity which may be perceived by humans is 1.78 mm/s for a seismic wave having 9 Hz frequency. On the other hand, the vibration velocities recorded at stations (KT3, KT4) within 152 m to 406 m distances to Katrancılar District are equal to 0.254

mm/s. Thus, it is impossible for inhabitants to perceive the ground vibrations. Inhabitants probably suppose to be subjected to high vibration levels due to the noise they hear during presplit blasts. To completely eliminate the perception of inhabitants, the ground vibration level may be limited to 2 mm/s. However, it must be remembered that ANSI permits vibration levels up to 12.7 mm/s for 1 blast a day or up to 6.35 mm/s for 12 blasts a day for the humans in the buildings during day time (Table 2.6).

The charge amount per delay is calculated as 168.57 kg for PPV=2 mm/s to prevent the perception of inhabitants completely for 1220 meters distance between Katrancilar District and the final pit boundary. But, a blast hole, having 165 mm diameter and 11 meters depth with a stemming length of 4.5 meters, can accommodate only 110 kg of explosive at maximum. Thus, it is concluded that Katrancilar District inhabitants won't perceive the vibration at all or perceive it so slightly that they won't be disturbed, as well as no damage will occur, since 110 kg charge per delay is less than 168.57 kg and very much less than 250.58 kg.

Distances at which PPV falls to the selected different limiting PPV values for various charge amounts per delay for Katrancilar District path are calculated (Table 5.9). Thus, the ground vibration velocity decreases to 5 mm/s, 3 mm/s and 2 mm/s at distances of 619.39 m, 795.07 m and 969.36 m respectively, when a charge of 110 kg is loaded per hole and one hole is detonated at a time. Besides, the vibration velocity, that is to be monitored at Katrancilar District, will certainly be lower than 2 mm/s in any case, since Katrancilar District is 1220 m distant to the final pit boundary.

Table 5.9 Distances at which PPV falls to the selected different limiting PPV values for various charge amounts per delay for Katrancilar District path

EXPLOSIVE AMOUNT PER DELAY (kg)	Distances (m) Calculated for Selected Limiting PPV Values			
	3.00 mm/s	5.00 mm/s	12.70 mm/s	19.00 mm/s
50	536.04	417.59	264.76	217.44
60	587.20	457.45	290.03	238.19
70	634.25	494.10	313.27	257.28
80	678.04	528.21	334.90	275.04
90	719.17	560.26	355.21	291.72
100	758.07	590.56	374.43	307.50
110	795.07	619.39	392.70	322.51
120	830.43	646.93	410.17	336.85
130	864.34	673.34	426.92	350.61
140	896.96	698.76	443.03	363.84
150	928.45	723.29	458.58	376.61
160	958.90	747.01	473.62	388.96

### 5.5. Evaluation of Previous Vibration Records

Mine management monitored the ground vibration and took records during blasting operations using their own devices before university began the study. Records stored in the memory of the device can not be altered by the user. For this reason, there is no doubt that the previous records are correct. The following are determined from the detailed examination made on the documents and the records.

- 1) The amount of explosives stored in the explosive magazine and the used amounts are recorded regularly. The blasting operations are conducted under auspices of gendarme by keeping records. The records of blasting plans and the



related technical information are kept in electronic form regularly. All the records are examined by the university in detail.

2) The previous records cover the period between 12 August 2005 and 28 June 2006. There are 75 ground vibration records taken.

3) Great majority of the previous records are taken at the monitoring stations coded as Temporary station, M3 and M5. Monitoring at Gümüşkol Village is conducted in parallel to monitoring at station M5 but in most of the cases no records were obtained. During previous monitoring, the stations coded Temporary station and M3 were at short distances such as 50 to 150 m from the blast sites, whereas M5 monitoring station was 406-950 m distant to the blast sites. Monitoring station M5 is still available next to the cemetery of Ovacik Village.

4) Monitoring at Gümüşkol Village, which is the nearest settlement to the mine, was carried out during all blasts by placing the device next to some buildings, however, only limited number of records were obtained. The distances of buildings at Gümüşkol Village were 1223 m to 1540 m distant to blast locations. For this reason, no vibration records were obtained when limited amount of charge per delay was detonated.

5) Ground vibration velocities, monitored within the mine site at Temporary station and M3 station at distances of 50 m to 150 m, ranges from 4.35 mm/s to 21.6 mm/s.

6) Ground vibration velocities monitored and recorded at M5 station at distances ranging between 457 m and 955 m from blast locations; vary from 0.88 mm/s to 4.91 mm/s.

7) Data related to monitoring conducted next to buildings and the records taken during previous blasts are summarized in Table 5.10. As it is seen from Table 5.10, all of the vibration velocities, monitored outside the building at the ground, are well below the limit, 19 mm/s, set in Turkish Regulation. In other saying, the buildings at settlements are subjected to ground vibrations less than the limit, 3 mm/s, set for structures under preservation order such as ruins, ancient and historic buildings, for seismic waves having frequencies less than 10 Hz, in DIN 4150 standard. Measured

velocities, given in Table 5.10, are verified by the records taken at distances of 1000 m or beyond which are presented in Tables 5.1, 5.4 and 5.7.

Table 5.10 Vibration recorded at the ground next to buildings during previous blasts

<b>Building Code</b>	<b>Measurement Date</b>	<b>Measured Vibration Value (mm/s)</b>
House 1	31 August 2005 25 October 2005	0.095 triggered from microphone 0.571
House 2	06 September 2005 05 October 2005	0.064 triggered from microphone 0.556
House 3	07 December 2005 17 February 2006	1.270 0.571
House 4	02 May 2006 18 May 2006 15 June 2006 23 June 2006 28 June 2006	0.556 0.730 0.508 0.651 2.320
House 5	18 May 2006	0.905

8) It is determined that the charge per delay varied between 80 kg and 111 Kg in general during the previous blasts. Examination of explosive consumption documents for previous blasts revealed the following exceptional charge amounts per delay; 113 kg (four times), 116 kg (two times), 119 kg (two times), 123 kg, 136 kg, 140 kg, 149 kg and 151 kg (once). Vibration velocity is recorded as 0.714 mm/s at a distance of 952.83 m when 123 kg per delay is detonated. Maximum charge per delay is calculated as 243.85 kg for the vibration not to exceed 3 mm/s at the ground of nearest settlement, Gümüşkol Village located at 1109 m distance from the final pit boundary. Thus, since the charge amount detonated per delay during previous blasts are much less than the allowable amount (151 kg < 243.85 kg) per delay, it is concluded that no structural damage was created at the nearby settlements, namely Gümüşkol Village, Karapınar District and Katrancılar District.

### 5.5.1. Allowable Vibration Velocity

The permitted level of PPV to be monitored and recorded at the ground outside the nearest building is 19 mm/s for seismic wave frequency range of 4 Hz to 10 Hz in Turkish Regulation. US Federal Regulation permits 19.05 mm/s vibration velocity for the same frequency range (Figure 2.8, OSM Regulations). Safe level of blasting vibrations permitted in USBM criteria is 12.7 mm/s for older houses and for seismic waves having frequencies in 3 Hz to 10 Hz range (Siskind et. al., 1980, USBM). However, none of the buildings in settlements closest to Kışladağ Gold Mine are engineered and most of them are clay mortared rubble stone structures. Since clay mortar doesn't have any tensile strength, in order not to cause structural damage even in the form of hairline cracks; use of allowable vibration criteria much lower than the limit of 19 mm/s permitted in Turkish Regulation and US Federal Regulation is found appropriate. This criterion is German DIN 4150 standard. The permitted levels for seismic waves having frequencies less than 10 Hz are set as 5 mm/s for dwellings and as 3 mm/s for structures particularly sensitive to vibration such as ruins, ancient and historic buildings in DIN 4150. Mine management is free to decide to use any vibration velocity criterion below 19 mm/s which is permitted in Turkish Regulation. However in this study, the vibration velocity that can be allowed at surrounding settlements is taken as 3 mm/s to remain on the safe side.

Ground vibration velocities monitored and recorded during the study are given and interpreted in Section 5.2 for Gümüşkol Village, in Section 5.3 for Karapınar District and in Section 5.4 for Katrancılar District. Recorded vibration velocities are lower than 1 mm/s within 500 m distance to Gümüşkol Village, 0.5 mm/s within 284 m distance to Karapınar District and 0.5 mm/s within 152 m distance to Katrancılar District. Thus the recorded velocities comply with DIN 4150 standard too. The maximum allowable charge amounts, that can be detonated per delay, are calculated using the permitted velocity of 3 mm/s in DIN 4150 standard for structures particularly sensitive to vibration, not to create even hairline cracks, and given in Tables 5.2, Table 5.5 and Table 5.8. It is determined that the charge

amount detonated per delay at present is much lower than the allowable amounts given in the above mentioned tables for the respective monitoring paths. Therefore, no damage has been occurred in the structures at the neighboring settlements. The maximum charge amount detonated per delay is 110 Kg in production blasting at present. If the same practice would be followed, and the maximum charge amount per delay would be kept below 240 kg's or preferably less than 155 Kg, no damage to structures and no perception of citizens would occur in the future.

### **5.5.2. Allowable Vibration Limit from Dominant Frequency Point of View**

The dominant frequency values of seismic waves, interpreted in detail in Sections 5.2, 5.3 and 5.4 vary from 6.38 Hz to 44.80 Hz in Gümüşkol path, from 6.25 Hz to 35.00 Hz in Karapınar path, and from 5.00 Hz to 46.40 Hz in Katrancılar path. Thus, even for the lowest dominant frequency case, the measured velocities comply with the regulation, since the permitted velocity of 19 mm/s in Turkish Regulation is valid for the frequency range of 4 Hz to 10 Hz. It is wanted to point out here that no damage will occur in the structures in the future even if the frequency of seismic waves is the lowest, i.e. 5 Hz.

The permitted vibration velocity of 19 mm/s in Turkish Regulation is applicable to engineered structures constructed in accordance with technical requirements. However, the technical conditions and the quality of structures in neighboring settlements are poor to tolerate the permitted vibration level in regulation. Thus, as it is explained in Section 5.5.1 above, it is aimed in this study that the vibration to be monitored at the ground in the surrounding settlements should not exceed 3 mm/s. This is the fact proven by the records taken at present and in the past. It is recommended hereby that the proposal made above should be followed by Kışladağ Gold Mine Management to remain at the safe side.

ANSI S3.29-1983 standard permits 6.35 mm/s peak vibration amplitude as tolerable limit for humans in buildings up to 12 blast events a day. However, it is known that

seismic waves with low frequency are easily perceived by humans. Thus, minimizing the human response and avoiding the possible complaints are important. Provision of a wider safety margin is foreseen from human response point of view and the interpretation is done using 3 mm/s vibration velocity as a criterion in this study. As it is mentioned before, the minimum perception level for the most sensitive humans is 1.78 mm/s. In other words, the humans won't perceive the vibrations at all, as long as a charge of 110 kg is detonated per delay, since the vibrations will be lower than 1 mm/s at settlements as in current practice, or the humans slightly perceive the vibrations in case of amplification.

### **5.5.3. Summary on Ground Vibration Evaluation**

The peak particle velocities measured at the stations nearest to each settlement and the calculated vibration velocities at 95 % confidence for the respective settlements nearest to the mine are summarized in Table 5.11.

All of the calculated velocities given in 6<sup>th</sup> row of Table 5.11 are less than 1.50 mm/s which can not be perceived directly by the humans. On the other hand, the measured velocities given in 8<sup>th</sup> row of the table are all very much less than that given in 6<sup>th</sup> row of the table. Remembering that the limit given in DIN 4150 standard for structures under preservation order is 3 mm/s, and the tolerable limit allowed by ANSI for humans in buildings is 6.35 mm/s, it is concluded that neither the structural damage nor the human disturbance occurred in the past as a result of blasting operations at the mine. It is also concluded that scaled distances greater than 150 are very safe from both structural damage and human perception points of view.

Table 5.11 Comparison of the calculated and the measured vibration velocities

	<b>SETTLEMENTS</b>		
	<b>Gümüřkol</b>	<b>Karapınar</b>	<b>Katrancılar</b>
<b>1.</b> Physical distances of settlements to final pit boundary	1109 m	1402 m	1220 m
<b>2.</b> Physical distances taken as a base for vibration velocity calculation	1100 m	1400 m	1200 m
<b>3.</b> Maximum allowable charge per delay not to exceed 3 mm/s limit	243.85 kg	489.69 kg	250.58 kg
<b>4.</b> Maximum allowable charge per delay not to exceed 2 mm/s limit	155.12 kg	257.56 kg	168.57 kg
<b>5.</b> Charge per delay used at present	110 kg	110 kg	110 kg
<b>6.</b> Ground vibration velocity calculated for 110 kg/delay charge at 95 % confidence	1.47 mm/s	1.17 mm/s	1.29 mm/s
<b>7.</b> The code of monitoring station nearest to the settlement under consideration	GK10	KR10	KT4
<b>8.</b> The vibration velocity measured at the respective monitoring station	0.254 mm/s	0.381 mm/s	0.254 mm/s
<b>9.</b> The scaled distance realized while monitoring at the respective monitoring station	153.82	210.96	166.00
<b>10.</b> The measured physical distance between the shot location and the corresponding station	1465.14 m	2090.11 m	1647.08 m
<b>11.</b> Charge detonated per delay while monitoring at the respective monitoring station	90.73 kg	98.16 kg	98.45 kg

## CHAPTER 6

### CONCLUSIONS AND RECOMMENDATIONS

A monitoring study is conducted to investigate and determine the damage potential of the structures and the risk of startle of the occupants at the neighboring settlements due to the possible ground borne effects of blasting operations carried out at Kışladağ Gold Mine. Turkish Regulation and US Federal Regulation are used in parallel for the evaluation of the monitored and recorded ground vibrations from structural damage potential point of view. The permitted ground vibration limit in Turkish Regulation is 19 mm/s, and it is 19.05 mm/s in US Federal Regulation for seismic waves having frequencies ranging from 4 to 10 Hz.

The permitted levels in Turkish Regulation and US Federal Regulation are valid for the structures which are engineered and constructed in accordance with construction regulation. It is concluded that the conditions of clay mortared structures in neighboring settlements can not tolerate 19 mm/s vibration velocity. Thus, the limit of 3 mm/s, permitted in DIN 4150 standard for the structures under preservation order such as the ruins, ancient and historic buildings, is taken as a basis for evaluation of damage potential.

The results of and the conclusions drawn from the investigation, together with the technical and administrative precautions to be taken are determined and given below;

1) The recorded vibration velocities are lower than 1 mm/s within a distance of 500 m to Gümüşkol Village, 0.5 mm/s within a distance of 284 m to Karapınar District and 0.5 mm/s within a distance of 152 m to Katrancılar District. Thus, no

damage has been occurred in structures at surrounding settlements in the past and at present.

2) The maximum charge amount detonated per delay in production blasts at present is 110 Kg. There will be no damage risk at all, in the future also, if the maximum charge amount per delay is kept below 240 Kg or more preferably less than 155 Kg.

3) The permitted ground vibration limit is given as 6.35 mm/s by American National Standards Institute (ANSI, S3.29-1983) for eliminating intolerable levels of vibration for humans in buildings up to 12 blast events per day. However, this limit is found to be high from structural damage point of view, taking the conditions of clay mortared buildings into account, and the vibration limit to be allowed in the ground at settlements is accepted as 3 mm/s to remain at the safe side.

4) 3 mm/s vibration limit is taken as a basis for the evaluation of human response and disturbance as well. The lowest vibration level that can be perceived by the most sensitive occupants in settlements is 1.78 mm/s by taking the frequency range of seismic waves into account. However, the highest vibration levels arriving at neighboring settlements are less than 1 mm/s. Thus, it is concluded that the occupants aren't disturbed by the direct effect of vibrations.

5) Scaled distance values in excess of 150 are found to be safe both from structural damage and human disturbance points of view.

6) It can be declared hereby that the ground vibration levels recorded during this study and analyzed from the past records comply with Turkish and US Federal regulations.

7) Continuous monitoring of ground vibrations are recommended not to cause any damage in structures in the inhabited areas surprisingly, which may arise from unexpected geological features as the open pit mine deepens. If an anomaly is observed in the records during continuous monitoring, necessary measures can be taken accordingly.



## REFERENCES

- Aimone-Martin C. T., Martell M. A., McKenna L. M., Siskind D. E., Dowding C. H., 2003 Comparative Study of Structure Response to Coal Mine Blasting. *U.S. Office of Surface Mining*. (accessed 2007) <http://www.osmre.gov/blastingindex.htm>
- Anon., 1956. "Blasting Claims, A Guide to Adjusters," *Association of Casualty and Surety Companies, New York*.
- Anon., 1977, "Cracking in Buildings," *Building Research Establishment Digest*, Vol. 75, Building Research Station, Garston, UK, 8 pp.
- American National Standards Institute (ANSI), S3.29-1983, USA, 1983
- Arseven B., 2003, "Blasting Optimization for the Assessment of Ground Vibrations at Demirbilek Panel of Tunçbilek Mine. Msc. Thesis, the Middle East Technical University, Ankara, Turkey, pp. 12-14.
- Atlas Powder Company (1987), "Explosive and Rock Blasting", pp. 321-406.
- Audell, H. S., 1996, Geotechnical Nomenclature and Classification System for Crack Patterns in Buildings, *Environmental and Engineering Geoscience*, Vol. II, No. 2, pp. 225 -248.
- Berta G., 1990, "Explosives: An Engineering Tool", Italesplosivi, Milano, Italy
- Bilgin, H. A., Esen, S. and Kiliç, M., 1998, *A Research for Solving the Environmental Problems due to Blasting at TKI Çan Lignite Mine*, Project No: 97-03-05-01-08, ODTÜ, Ankara, Turkey, 100 pages, in Turkish.

Bilgin, H. A., Esen, S. and Kiliç, M., 1999, *Effect of Blasting Induced Ground Vibrations on Buildings and the Importance of the Amplification Factor*, 16th Mining Congress, Ankara, Turkey, pp. 25-32, in Turkish.

Bilgin, H.A., Esen, S., Kılıç, M. and Aldaş, G.G.U., 2000, Investigation of Blast Induced Ground Vibrations at Yenikoy Open Pit Lignite Mine, 4<sup>th</sup> Drilling and Blasting Symposium, Ankara, pp. 147-158 (in Turkish).

Bilgin, H.A., Kılıç, M., İnal, H.S. ve Büyükyıldırım, K., 2004, Risk Assessment for Blasting Vibrations at Kecioren Subway Construction, Project Code: 04-03-05-2-00-03, METU, Ankara, Final Report, 87 pages (in Turkish).

Bilgin, H.A., İnal, H.S. ve Büyükyıldırım, K., 2005, Risk Assessment for Gumuspinar Village due to Blasting at BLI Orhaneli Open Pit Lignite Mine, Project Code: 05-03-05-2-00-08, METU, Ankara, Final Report, 86 pages (in Turkish).

Bilgin, H.A. and Çakmak, B. B., 2006, Environmental Impact Assessment for Blasting at Raw Material Quarry of Konya Cement Factory, Project Code: 06-03-05-1-00-12, METU, Ankara, Final Report, 58 pages (in Turkish).

Bilgin, H.A., Çakmak, B. B. and Hacıosmanoğlu, M. E., 2007, Environmental Impact Assessment for Blasting Operations for Kışladağ Gold Mine, Project Code: 06-03-05-2-00-06, METU, Ankara, Final Report, 89 pages.

Dimitrios C. and Dimitrios G., 2001, Blasting Vibration Limits to Prevent Human Annoyance Remarks from some Case Studies. *Mineral Resources Engineering*, Vol. 10, No. 1, pp.71-82.

Djordjevic N., Kavetsky A., and Scott A., 1990, Blast Design Optimization to Minimize Induced Vibrations of Structures. *International Journal of Blasting and Fragmentation*, pp. 373-380.

Dowding, C. H., Beck W. K., and Atmatzidis D. K., 1980, Blast Vibration Implications of Cyclic Shear Behavior of Model Plaster Panels. *Geotechnical Testing J., ASTM*, v. 3, No. 2.

Dowding, C. H., Murray, P. D., and Atmatzidis, D. K., 1981, "Dynamic Response Properties of Residential Structures Subjected to Blasting Vibrations," *Journal of Structural Engineering*. Vol. 107, No. ST2, pp. 1233-1249.

Dowding, C.H., 1985, *Blast Vibration Monitoring and Control*. Prentice-Hall, Englewood Cliffs, 297 p.

Dowding, C. H., 1988, "Comparison of Environmental and Blast Induced Effects through Computerized Surveillance," *The Art and Science of Geotechnical Engineering at the Dawn of the 21st Century*, R. B. Peck Honorary Volume, W. J. Hall, ed., Prentice-Hall Englewood Cliffs, NJ, pp. 143-160.

Dowding, C. H. and Aimone C. T., 1992, Rock Breakage, Explosives. *Mining Engineering Handbook*, Chapter 9.2, pp. 722-746.

Dowding, C. H., 1992, "Monitoring and Control of Blast Effects". *Mining Engineering Handbook*, Vol. 1, pp. 746-760.

Dowding, C.H., 1996, *Construction Vibrations*, Prentice Hall, Upper Saddle River, 598 pages.

Duvall W. I., 1966, *Empirical Approach to Problems in Blasting, Failure and Breakage of Rocks.*, Ch 28., pp 500-523.

Esen, S. and Bilgin H. A., 2001, Evaluation of Blast Vibrations from Sekköy Surface Coal Mine in Turkey, *Proceedings of the Twenty-Seventh Annual*

*Conference on Explosives and Blasting Technique*. Orlando, Florida, USA, Vol. 1, pp. 313-327.

Edwards, A. T., and Northwood, T. D. (1960), "Experimental Studies of the Effects of Blasting on Structures," *The Engineer*, Vol. 210, 40 pp.

Erkoc, O.Y. and Esen, S., 1998, Monitoring and Evaluation of Blast Induced Ground Vibrations, 3<sup>rd</sup> Drilling and Blasting Symposium, Ankara, pp.139-147 (in Turkish).

Kahrman A., 2001a, Prediction of Particle Velocity Caused by Blasting for an Infrastructure Excavation Covering Granite Bedrock. *Mineral Resources Engineering*, Vol. 10, No. 2, pp. 205-218.

Kahrman A., 2001b, Analysis of Ground Vibrations Caused by Bench Blasting at Can Open-pit Lignite Mine in Turkey. *Environmental Geology*, Vol. 41, pp. 653-661.

Konya C. J. and Walter E. J., 1991, "Rock Blasting and Overbreak Control", National Highway Institute, 415 pp.

Kutter H.K. & Fairhurst C., 1971, On the Fracture Process in Blasting. *International Journal of Rock Mech. Min. Sci. & Geomech Abstr.* Vol. 8, p 181-202, Pergamon Press.

Langefors, U., B. Kihlstrom, and H. Westerberg., 1958, Ground Vibrations in Blasting. *Water Power*, pp. 421-424.

Langefors U. and Kihstrom B., 1967, The Modern Technique of Rock Blasting. Almquist and Wiksell. Upsalla, Sweden, (*John Wiley and Sons, New York, 405 p*).

Lewis Geoscience Services Inc., 2002, Report on Geological Mapping and Structural Analysis, Kışladağ Au Project, Western Turkey, 46 pages.

Medearis, K., 1976, The Development of Rational Damage Criteria for Low-Rise Structures Subjected to Blasting Vibrations. *Kenneth Medearis Associates, Final Rept. to National Crushed Stone Assn.*, Washington, D. C., 93 pp.

Newmark, N. M. and Hall, W. J., 1982, *Earthquake Spectra and Design*, Earthquake Engineering Research Institute, Berkeley, CA, 103 pp.

Nicholls, H. R., Johnson, C. F., and Duvall, W. I., 1971, Blasting Vibrations and Their Effects on Structures. *BuMines Bull.* 656.

Nick, S., 2002, Preliminary Vibration Assessment-Tahi Street, Mapua, Nelson. Prepared for *TONKIN & TAYLOR LTD.*, <http://www.tdc.govt.nz/pdfs/394.pdf>.

Northcote, K.E., 1999. Petrographic descriptions for 30 samples from the Kışladağ deposit, prepared for the Eldorado Gold Corporation. June 30, 1999.

Northwood, T. D., Crawford, R., and Edwards, A. T., 1963, "Blasting Vibrations and Building Damage," *Engineer*, Vol. 215, No. 5601, May.

Olofsson S. O., 1988, Applied Explosives Technology for Construction and Mining, *Applex, Arla, Sweden*, 304 p.

Orhan, A. A., 2004, Geologic Investigation Report as a Basis for Local Construction Plan for Kışladağ Gold Mine (UŞAK), 33 pages (in Turkish).

Persson P. A., 1978, The Basic Mechanisms in Rock Blasting. Proc. 2. *International Congress on Rock Mechanics*. Vol. 111b., Belgrade.

Singh S. P., 1999, The Effects of Shock and Gas Energies on Fracturing Process. *Proceedings of the 25th Annual Conference of Explosives and Blasting Technique.*, p397-406, Tennessee, USA.

Siskind, D. E., Stagg, M.S., Kopp, J.W., Dowding, C.H., 1980, Structure Response and Damage Produced by Ground Vibration From Surface Mine Blasting, RI 8507, *United States Bureau of Mines, Report of Investigation 8507*, 75 pages.

Siskind, D.E., Crum, S.V. and Plis, M.N., 1993, Blast Vibrations and Other Potential Causes of Damage in Homes Near a Large Surface Coal Mine in Indiana, RI 9455, Bureau of Mines, 62 pages.

Siskind, D.E., 2000, Vibrations from Blasting, International Society of Explosives Engineers, 120 p.

Stagg, M. S., and A. J. Engler, 1980, Ground Vibration Measurement and Seismograph Calibration. *BuMines RI. 8506*.

Stagg, M. S., Siskind, D. E., Stevens, M. G., and Dowding, C. H., 1984. "Effects of Repeated Blasting on a Wood-Frame House," *Report of Investigations 8896, US Bureau of Mines*, Washington, DC, 82 pp.

The Office of Surface Mining Reclamation and Enforcement, 1983, Federal Register, 30 CFR Parts, 715, 780, 816 and 817, Vol. 48, No. 46, Rules and Regulations (governing the blasts associated with surface and underground mines), pp. 9788-9811.

Thonen, J. R., and Windes, S. L., 1942, "Seismic Effects of Quarry Blasting," *Bulletin 441, US Bureau of Mines*, Washington, DC. 83 pp.

Turkish Republic Official Gazette, 2005, No. 25862, Turkish Regulation on Evaluation and Management of Environmental Noise, (in Turkish) 59 articles, 7 Appendices.

USBM Bulletin, OSM Bulletin, USA, 1983.

Wiss, J. F., and P. Linehan, 1979, Control of Vibration and Blast Noise from Surface Coal Mining. *BuMines Open File Rept.*.

# APPENDIX A



## Event Report

Date/Time Long at 15:40:24 June 28, 2006  
 Trigger Source Geo: 0.510 mm/s  
 Range Geo: 31.7 mm/s  
 Record Time 4.0 sec (Auto=3Sec) at 2048 sps  
 Job Number: 1

Serial Number BE10316 V 8.01-8.0 MiniMate Plus  
 Battery Level 6.3 Volts  
 Calibration June 29, 2005 by Instantel, Inc  
 File Name L316B7QJ.JCO  
 Scaled Distance 30.0 (300.0 m, 100.0 kg)

Notes  
 Location:  
 Client:  
 User Name:  
 General:

Extended Notes

Post Event Notes

Microphone Linear Weighting  
 PSPL 109.5 dB(L) at 1.424 sec  
 ZC Freq 4.5 Hz  
 Channel Test Passed (Freq = 20.1 Hz Amp = 499 mv)

	Tran	Vert	Long	
PPV	1.62	2.19	2.32	mm/s
ZC Freq	10.3	11.6	16.8	Hz
Time (Rel. to Trig)	0.764	0.857	0.741	sec
Peak Acceleration	0.0431	0.0431	0.0431	g
Peak Displacement	0.0214	0.0226	0.0217	mm
Sensorcheck	Passed	Passed	Passed	
Frequency	7.4	7.2	7.6	Hz
Overswing Ratio	3.6	3.7	3.7	

USBM R18507 And OSMRE

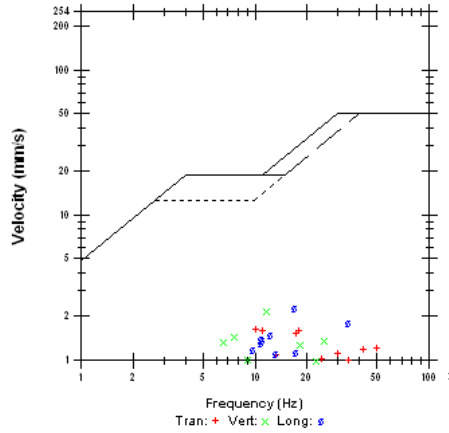

Peak Vector Sum: 2.49 mm/s at 0.741 sec

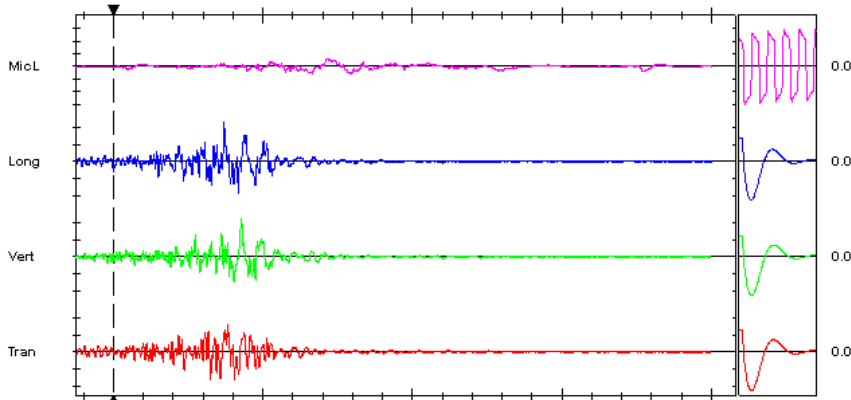

Time Scale: 0.20 sec/div Amplitude Scale: Geo: 1.000 mm/s/div Mic: 10.00 pa.(L)/div  
 Trigger = Sensorcheck

Printed: August 20, 2007 (V 8.01 - 8.01)

Format Copyrighted 1996-2004 Instantel, Inc.

Figure A.1 1st vibration record taken along Gümüskol village path.





### Event Report

Date/Time	Vert at 15:41:38 June 28, 2006	Serial Number	BE10317 V8.01-8.0 MiniMate Plus
Trigger Source	Geo: 0.508 mm/s	Battery Level	6.3 Volts
	Mic: 110 dB(L)	Calibration	June 29, 2005 by Instantel.Inc
Range	Geo :31.7 mm/s	File Name	L317B7.QJ.LE0
Record Time	4.0 sec (Auto=3Sec) at 2048 sps	Scaled Distance	99.0 (700.0 m, 50.0 kg)
Job Number:	1		

**Notes**

Location:  
Client:  
User Name:  
General:

**Extended Notes**

**Post Event Notes**

Microphone Linear Weighting  
 PSPL 102.8 dB(L) at 1.220 sec  
 ZC Freq 5.6 Hz  
 Channel Test Passed (Freq = 20.1 Hz Amp = 466 mv)

	Tran	Vert	Long	
PPV	2.02	1.37	2.02	mm/s
ZC Freq	10.3	8.7	11.6	Hz
Time (Rel. to Trig)	0.531	0.271	0.641	sec
Peak Acceleration	0.0232	0.0166	0.0331	g
Peak Displacement	0.0319	0.0189	0.0250	mm
Sensorcheck	Passed	Passed	Passed	
Frequency	7.5	7.5	7.3	Hz
Overswing Ratio	3.7	3.8	3.8	

**USBM R18507 And OSMRE**

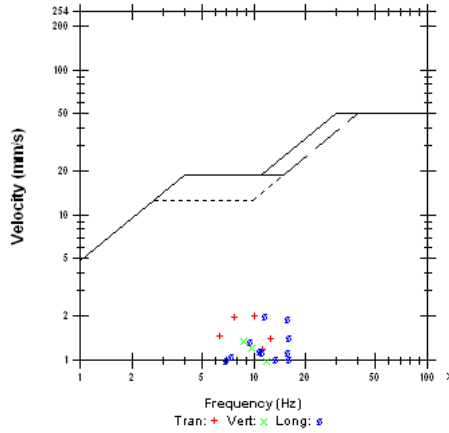

Peak Vector Sum 2.20 mm/s at 0.409 sec

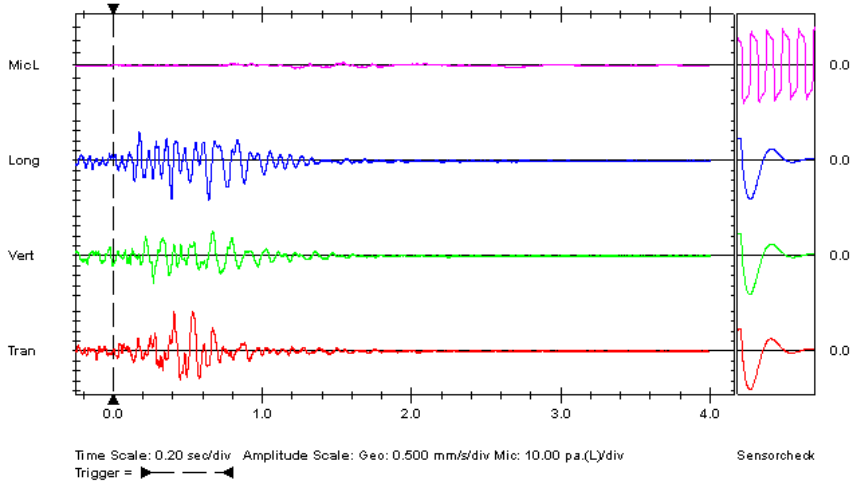

Printed: August 20, 2007 (V8.01-8.01) Format Copyrighted 1996-2004 Instantel Inc.

**Figure A.2** 2nd vibration record taken along Gümüşkol village path.

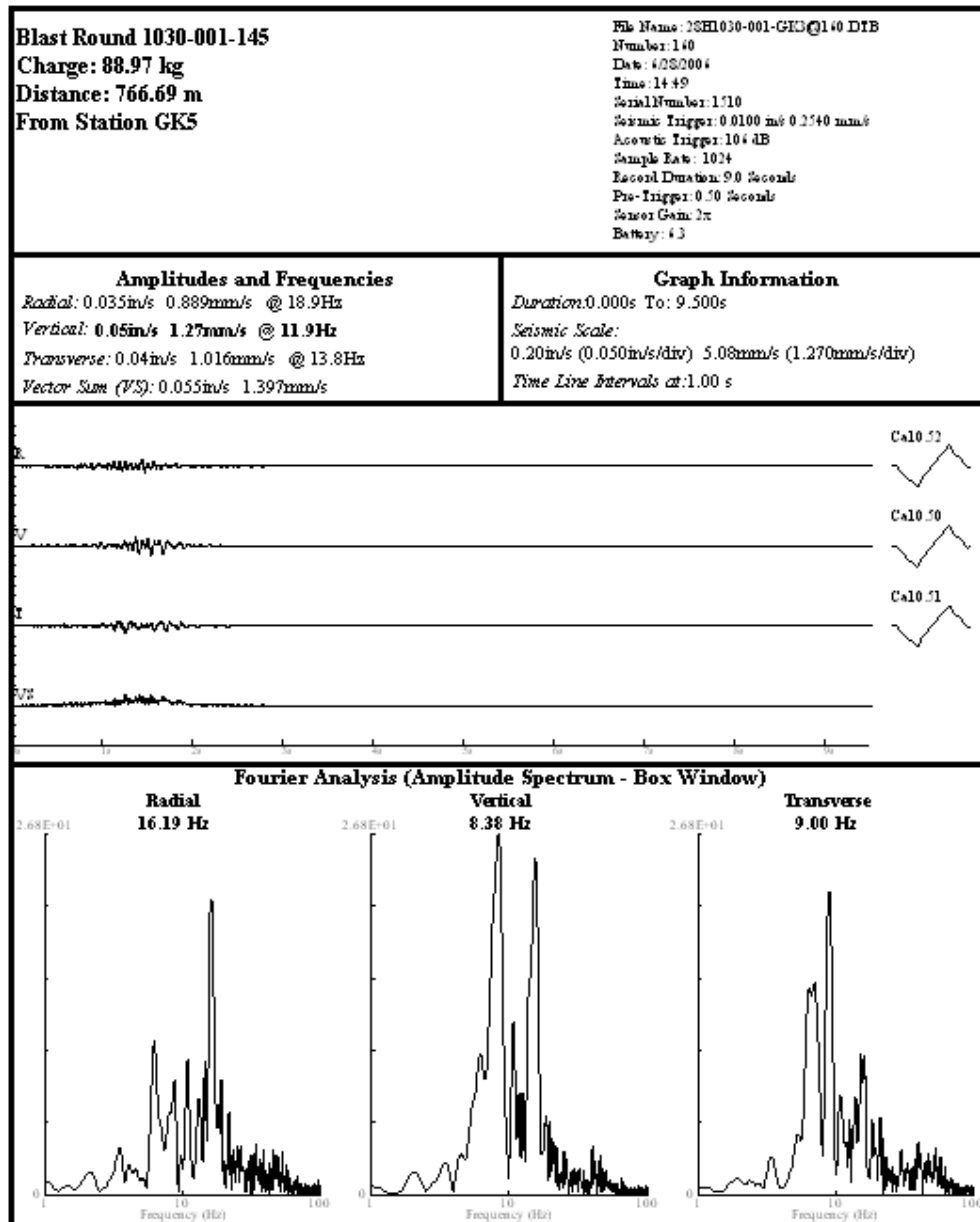

Figure A.3 3rd vibration record taken along Gümüşkol village path.



## Event Report

Date/Time Long at 15:44:12 June 29, 2006  
 Trigger Source Geo: 0.508 mm/s  
 Range Geo :31.7 mm/s  
 Record Time 5.0 sec (Auto=3Sec) at 2048 sps  
 Job Number: 1

Serial Number BE10317 V 8.01-8.0 MiniMate Plus  
 Battery Level 6.3 Volts  
 Calibration June 29, 2005 by Instantel, Inc  
 File Name L317B7 SE.D00  
 Scaled Distance 99.0 (700.0 m, 50.0 kg)

Notes  
 Location:  
 Client:  
 User Name:  
 General:

### Extended Notes

Post Event Notes  
 29 Haziran 2006 gunu bir delikte 88.5 kg kullanılarak yapilan uretim patlatmasinin ocagin hemen uzerinde 216.8 m mesafede alınan kaydi

Microphone Linear Weighting  
 PSPL 109.9 dB(L) at 0.994 sec  
 ZC Freq 5.5 Hz  
 Channel Test Passed (Freq = 20.1 Hz Amp = 538 mv)

	Tran	Vert	Long	
PPV	8.48	5.92	8.41	mm/s
ZC Freq	35	30	23	Hz
Time (Rel. to Trig)	1.163	1.150	0.551	sec
Peak Acceleration	0.275	0.192	0.229	g
Peak Displacement	0.0351	0.0280	0.0580	mm
Sensorcheck	Passed	Passed	Passed	
Frequency	7.5	7.5	7.4	Hz
Overswing Ratio	3.7	3.9	4.0	

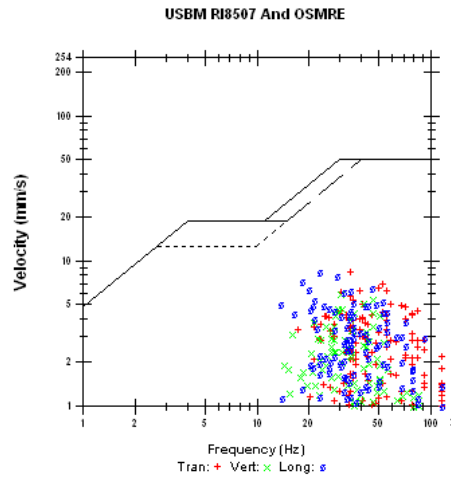

Peak Vector Sum 8.99 mm/s at 1.163 sec

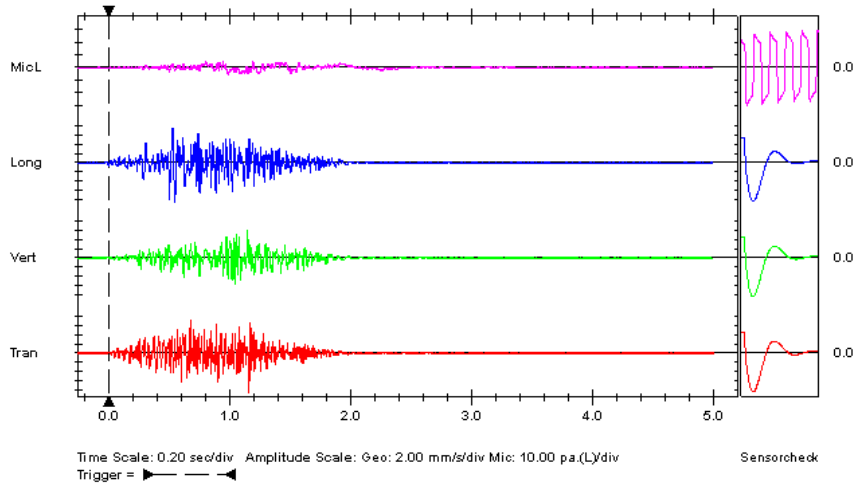

Printed: August 20, 2007 (V 8.01-8.01)

Format Copyrighted 1996-2004 Instantel Inc.

**Figure A.4** 4th vibration record taken along Gümüskol village path.



## Event Report

Date/Time	Tran at 15:44:11 June 29, 2006	Serial Number	BE10316 V 8.01-8.0 MiniMate Plus
Trigger Source	Geo: 0.510 mm/s	Battery Level	6.3 Volts
	Mic: 135 dB(L)	Calibration	June 29, 2005 by Instantel, Inc
Range	Geo :31.7 mm/s	File Name	L316B7SE.DNO
Record Time	4.5 sec (Auto=3Sec) at 2048 sps	Scaled Distance	30.0 (300.0 m, 100.0 kg)
Job Number:	1		

Notes  
Location:  
Client:  
User Name:  
General:

Extended Notes

Post Event Notes

Microphone Linear Weighting  
PSPL 102.8 dB(L) at 1.510 sec  
ZC Freq 4.2 Hz  
Channel Test Passed (Freq = 20.1 Hz Amp = 478 mv)

	Tran	Vert	Long	
PPV	2.52	1.90	2.21	mm/s
ZC Freq	12.2	28	20	Hz
Time (Rel. to Trig)	0.521	0.847	0.438	sec
Peak Acceleration	0.0630	0.0431	0.0663	g
Peak Displacement	0.0240	0.0115	0.0148	mm
Sensorcheck	Passed	Passed	Passed	
Frequency	7.5	7.2	7.5	Hz
Overswing Ratio	3.4	3.6	3.5	

USBM R18507 And OSMRE

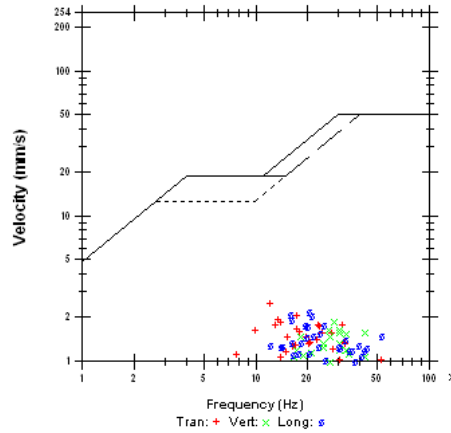

Peak Vector Sum 2.90 mm/s at 0.869 sec

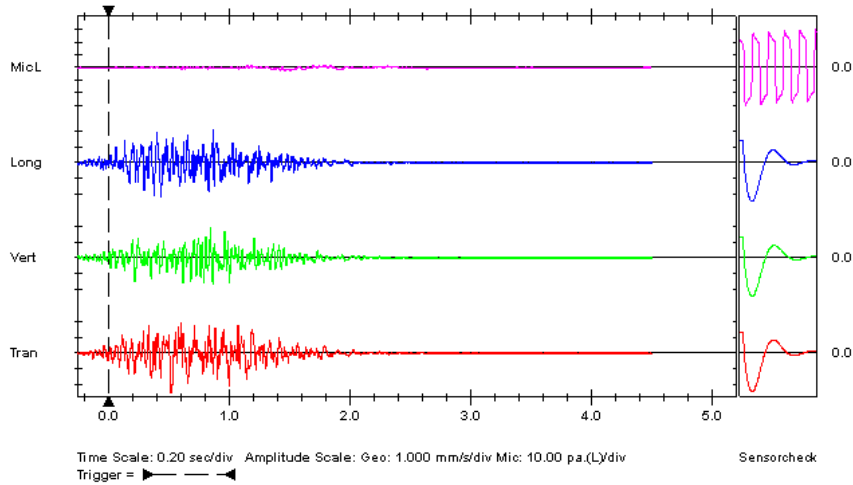

Printed: August 20, 2007 (V 8.01-8.01)

Format Copyrighted 1996-2004 Instantel Inc.

Figure A.5 5th vibration record taken along Gümüskol village path.

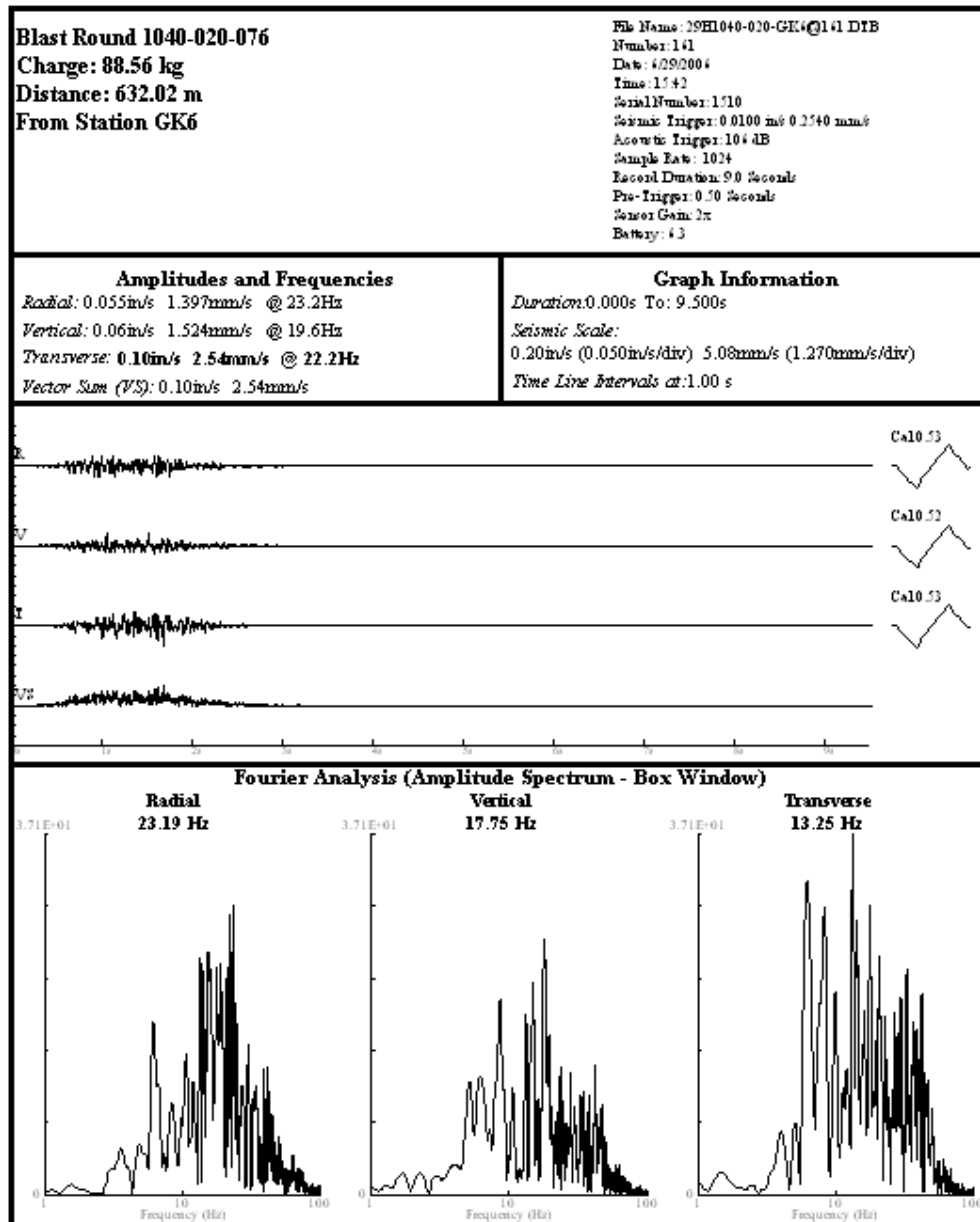

Figure A.6 6th vibration record taken along Gümüskol village path.



### Event Report

Date/Time Long at 16:11:26 July 3, 2006  
 Trigger Source Geo: 0.508 mm/s  
 Range Geo :31.7 mm/s  
 Record Time 3.75 sec (Auto=3Sec) at 2048 sps  
 Job Number: 1

Serial Number BE10317 V 8.01-8.0 MiniMate Plus  
 Battery Level 6.2 Volts  
 Calibration June 29, 2005 by Instantel, Inc  
 File Name L317B7ZU.B20  
 Scaled Distance 99.0 (700.0 m, 50.0 kg)

Notes  
 Location:  
 Client:  
 User Name:  
 General:

Extended Notes

Post Event Notes

Microphone Linear Weighting  
 PSPL 108.8 dB(L) at 1.884 sec  
 ZC Freq 4.8 Hz  
 Channel Test Passed (Freq = 20.5 Hz Amp = 539 mv)

	Tran	Vert	Long	
PPV	0.889	0.714	0.794	mm/s
ZC Freq	25	28	28	Hz
Time (Rel. to Trig)	0.154	0.091	0.537	sec
Peak Acceleration	0.0232	0.0199	0.0232	g
Peak Displacement	0.00819	0.00611	0.00507	mm
Sensorcheck	Passed	Passed	Passed	
Frequency	7.5	7.4	7.2	Hz
Overswing Ratio	3.8	3.9	4.0	

USBM R18507 And OSMRE

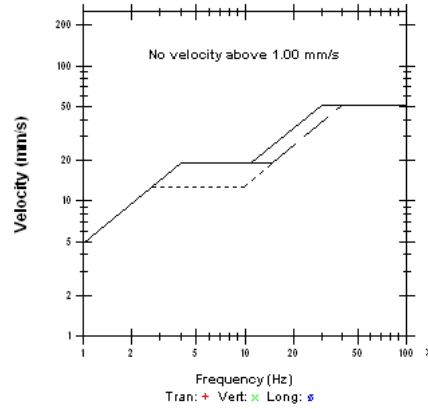

Peak Vector Sum 1.01 mm/s at 0.539 sec

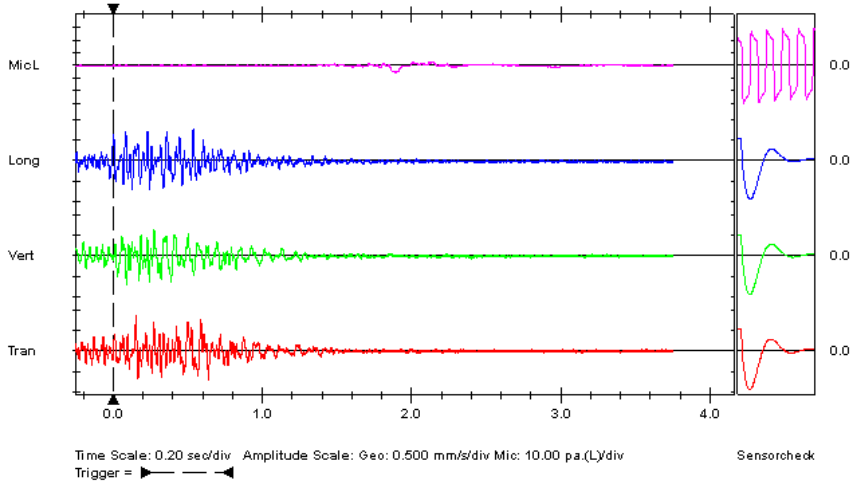

Printed: August 20, 2007 (V 8.01 - 8.01)

Format Copyrighted 1996-2004 Instantel Inc.

Figure A.7 7th vibration record taken along Gümüskol village path.



## Event Report

Date/Time Long at 16:11:16 July 3, 2006  
 Trigger Source Geo: 0.510 mm/s  
 Range Geo :31.7 mm/s  
 Record Time 3.75 sec (Auto=3Sec) at 2048 sps  
 Job Number: 1

Serial Number BE10316 V 8.01-8.0 MiniMate Plus  
 Battery Level 6.2 Volts  
 Calibration June 29, 2005 by Instantel, Inc  
 File Name L316B7ZU.A50  
 Scaled Distance 30.0 (300.0 m, 100.0 kg)

Notes  
 Location:  
 Client:  
 User Name:  
 General:

Extended Notes

Post Event Notes

Microphone Linear Weighting  
 PSPL 108.0 dB(L) at 1.966 sec  
 ZC Freq 3.5 Hz  
 Channel Test Passed (Freq = 20.1 Hz Amp = 521 mv)

	Tran	Vert	Long	
PPV	0.746	0.508	0.730	mm/s
ZC Freq	24	18.6	26	Hz
Time (Rel. to Trig)	0.499	0.671	0.034	sec
Peak Acceleration	0.0166	0.0133	0.0199	g
Peak Displacement	0.00718	0.00379	0.00572	mm
Sensorcheck	Passed	Passed	Passed	
Frequency	7.5	7.3	7.5	Hz
Overswing Ratio	3.6	3.7	3.7	

USBM R18507 And OSMRE

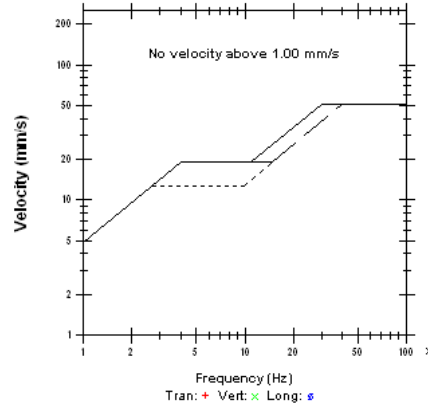

Peak Vector Sum 0.774 mm/s at 0.053 sec

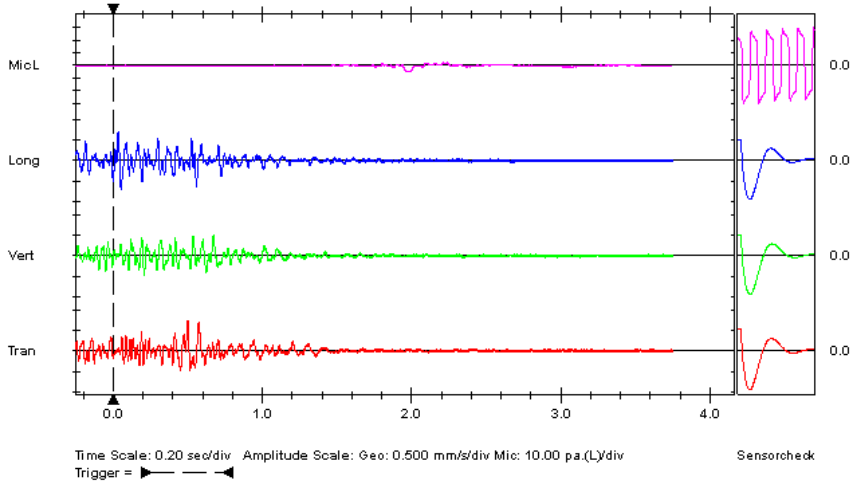

Printed: August 20, 2007 (V 8.01-8.01)

Format Copyrighted 1996-2004 Instantel Inc.

Figure A.8 8th vibration record taken along Gümüskol village path.

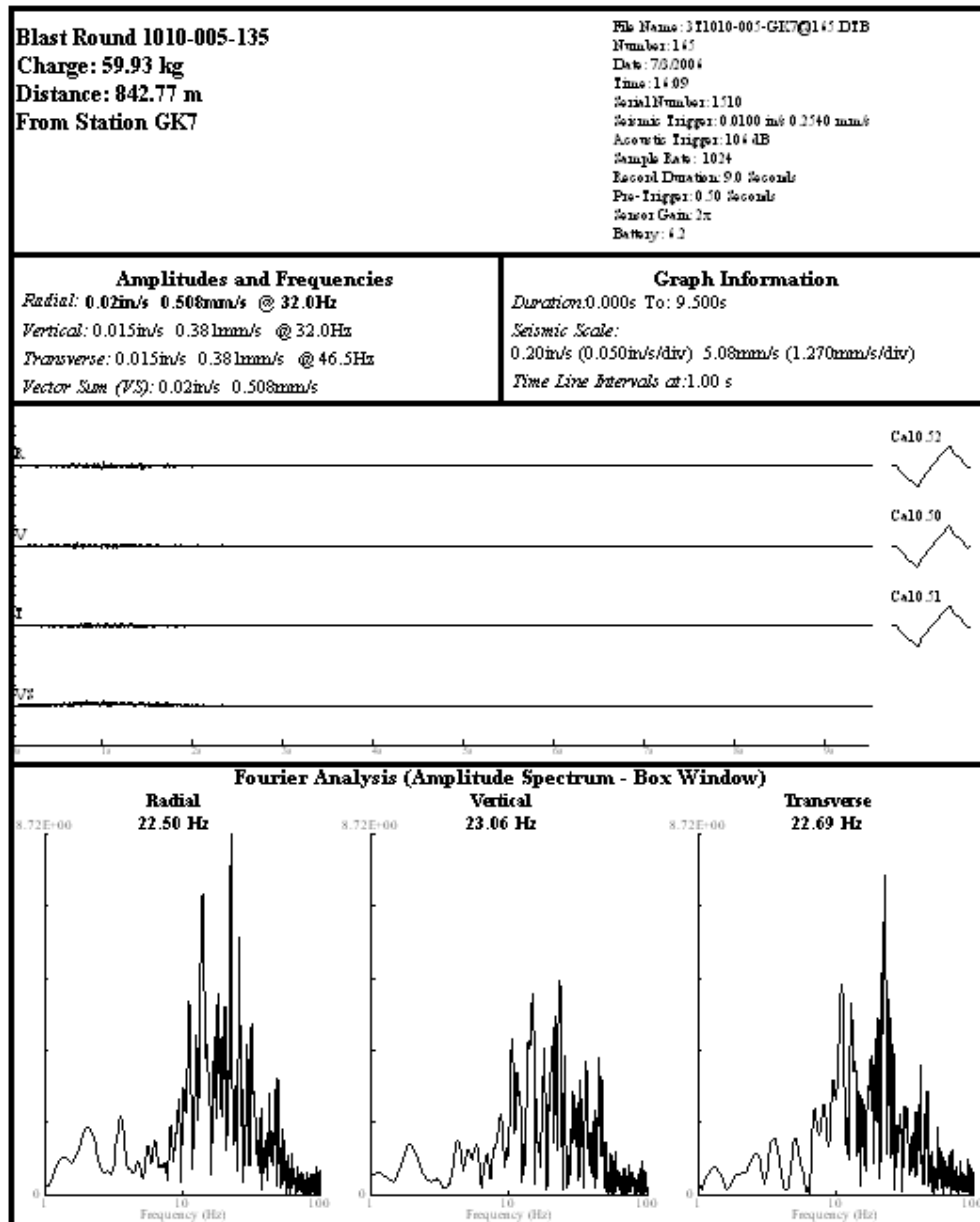

Figure A.9 9th vibration record taken along Gümüskol village path.





## Event Report

Date/Time	Tran at 16:41:10 July 6, 2006	Serial Number	BE10317 V 8.01-8.0 MiniMate Plus
Trigger Source	Geo: 0.508 mm/s	Battery Level	6.2 Volts
	Mic: 110 dB(L)	Calibration	June 29, 2005 by Instantel, Inc
Range	Geo :31.7 mm/s	File Name	L317B85F.DM0
Record Time	4.25 sec (Auto=3Sec) at 2048 sps	Scaled Distance	99.0 (700.0 m, 50.0 kg)
Job Number:	1		

### Notes

Location:  
Client:  
User Name:  
General:

### Extended Notes

### Post Event Notes

Microphone Linear Weighting  
 PSPL 104.9 dB(L) at 1.519 sec  
 ZC Freq 6.0 Hz  
 Channel Test Passed (Freq = 20.1 Hz Amp = 546 mv)

	Tran	Vert	Long	
PPV	1.65	0.952	1.51	mm/s
ZC Freq	11.5	23	16.5	Hz
Time (Rel. to Trig)	0.772	0.923	0.864	sec
Peak Acceleration	0.0232	0.0232	0.0298	g
Peak Displacement	0.0200	0.0135	0.0140	mm
Sensorcheck	Passed	Passed	Passed	
Frequency	7.5	7.4	7.3	Hz
Overswing Ratio	3.7	3.8	3.9	

Peak Vector Sum 1.77 mm/s at 0.771 sec

### USBM R18507 And OSMRE

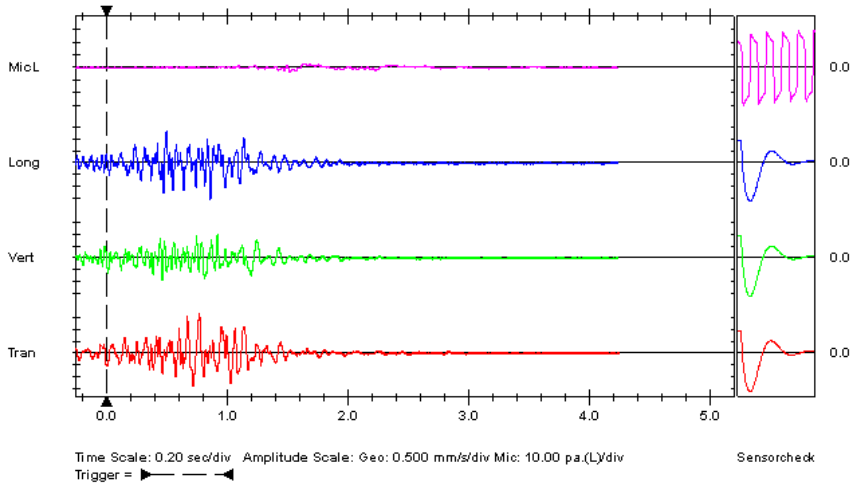
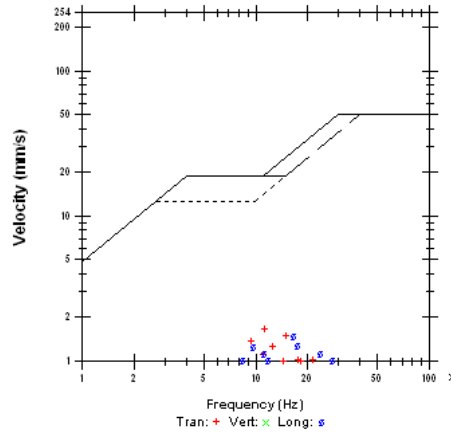

Printed: August 20, 2007 (V 8.01-8.01)

Format Copyrighted 1996-2004 Instantel Inc.

**Figure A.10** 10th vibration record taken along Gümüşkol village path.

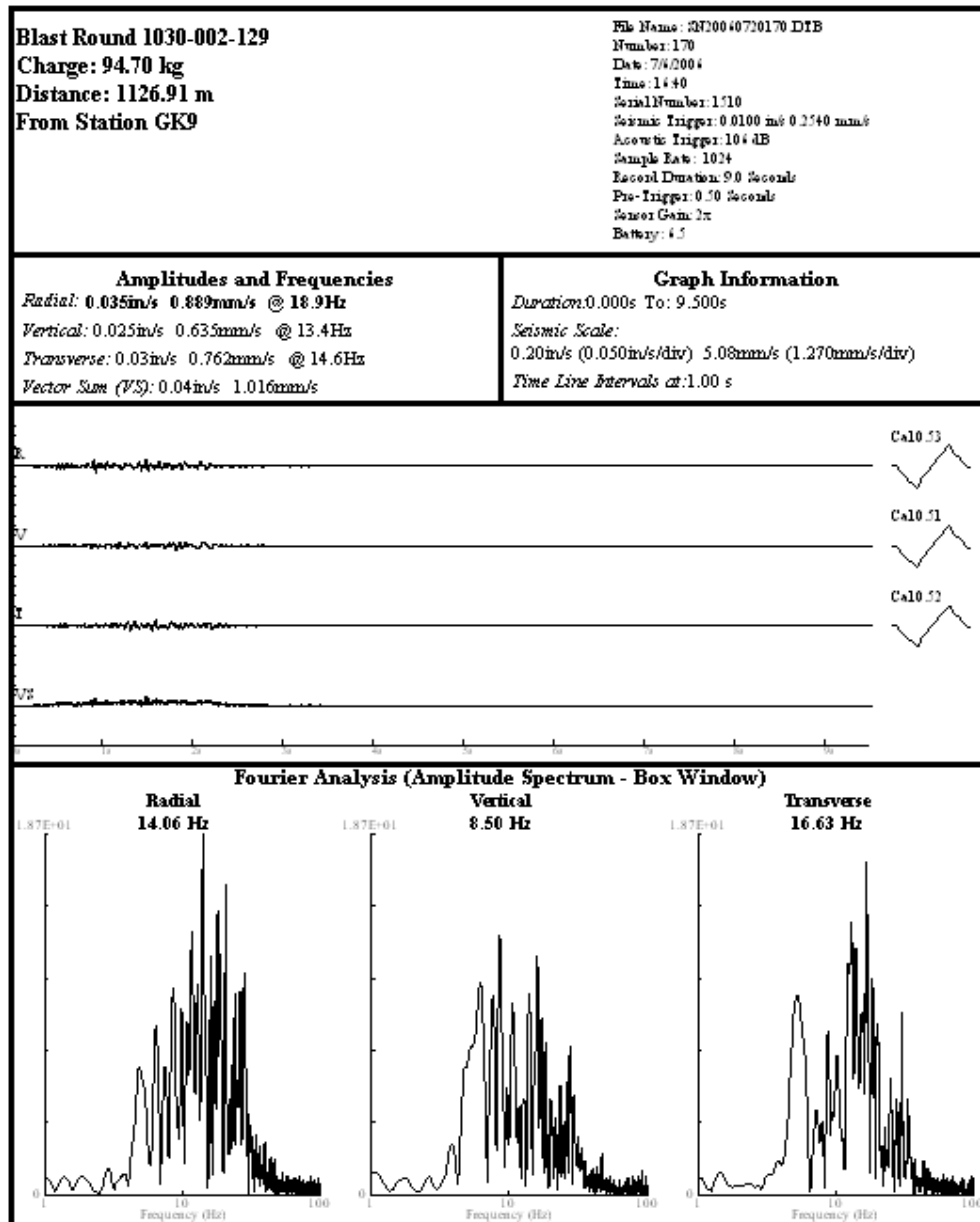

Figure A.11 11th vibration record taken along Gümüskol village path.



## Event Report

Date/Time	Tran at 16:15:09 July 7, 2006	Serial Number	BE10317 V 8.01-8.0 MiniMate Plus
Trigger Source	Geo: 0.508 mm/s	Battery Level	6.1 Volts
	Mic: 110 dB(L)	Calibration	June 29, 2005 by Instantel, Inc
Range	Geo :31.7 mm/s	File Name	L317B879.590
Record Time	4.75 sec (Auto=3Sec) at 2048 sps	Scaled Distance	99.0 (700.0 m, 50.0 kg)
Job Number:	1		

### Notes

Location:  
Client:  
User Name:  
General:

### Extended Notes

### Post Event Notes

Microphone Linear Weighting  
 PSPL 105.5 dB(L) at 2.457 sec  
 ZC Freq 10.9 Hz  
 Channel Test Passed (Freq = 20.1 Hz Amp = 439 mv)

	Tran	Vert	Long	
PPV	1.57	2.03	1.70	mm/s
ZC Freq	14.0	17.7	19.7	Hz
Time (Rel. to Trig)	0.973	0.870	0.656	sec
Peak Acceleration	0.0298	0.0298	0.0298	g
Peak Displacement	0.0171	0.0181	0.0162	mm
Sensorcheck	Passed	Passed	Passed	
Frequency	7.4	7.3	7.6	Hz
Overswing Ratio	3.5	3.6	3.5	

### USBM R18507 And OSMRE

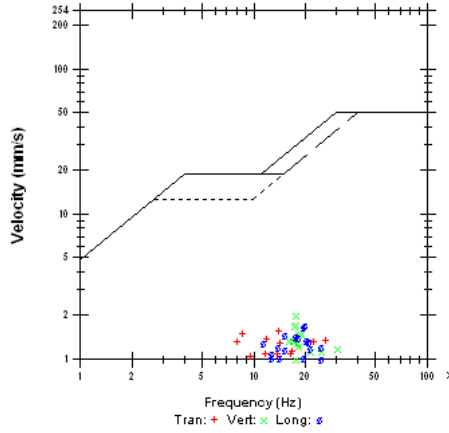

Peak Vector Sum 2.17 mm/s at 0.973 sec

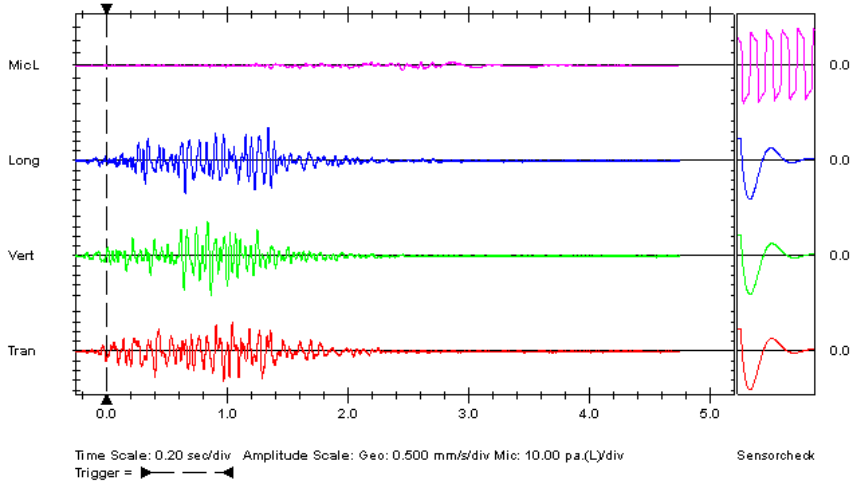

Printed: August 20, 2007 (V 8.01-8.01)

Format Copyrighted 1996-2004 Instantel Inc.

**Figure A.12** 12th vibration record taken along Gümüüşkol village path.



### Event Report

Date/Time Long at 16:06:56 July 7, 2006  
 Trigger Source Geo: 0.510 mm/s  
 Range Geo :31.7 mm/s  
 Record Time 4.5 sec (Auto=3Sec) at 2048 sps  
 Job Number: 1

Serial Number BE10316 V 8.01-8.0 MiniMate Plus  
 Battery Level 6.1 Volts  
 Calibration June 29, 2005 by Instantel, Inc  
 File Name L316B678.RK0  
 Scaled Distance 30.0 (300.0 m, 100.0 kg)

Notes  
 Location:  
 Client:  
 User Name:  
 General:

Extended Notes

Post Event Notes

Microphone Linear Weighting  
 PSPL 100.0 dB(L) at 2.740 sec  
 ZC Freq 9.3 Hz  
 Channel Test Passed (Freq = 20.1 Hz Amp = 492 mv)

	Tran	Vert	Long	
PPV	1.17	1.24	1.56	mm/s
ZC Freq	14.0	23	25	Hz
Time (Rel. to Trig)	1.020	0.906	0.838	sec
Peak Acceleration	0.0265	0.0265	0.0298	g
Peak Displacement	0.00959	0.00974	0.00964	mm
Sensorcheck	Passed	Passed	Passed	
Frequency	7.7	7.5	7.3	Hz
Overswing Ratio	3.7	3.8	3.9	

USBM R18507 And OSMRE

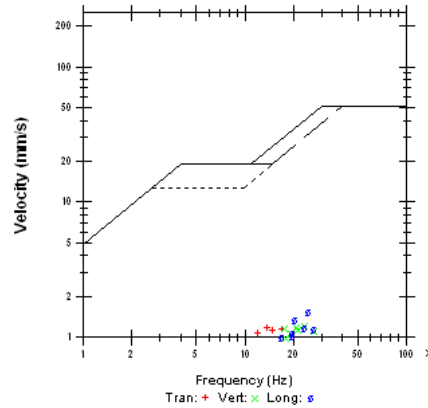

Peak Vector Sum 1.65 mm/s at 0.932 sec

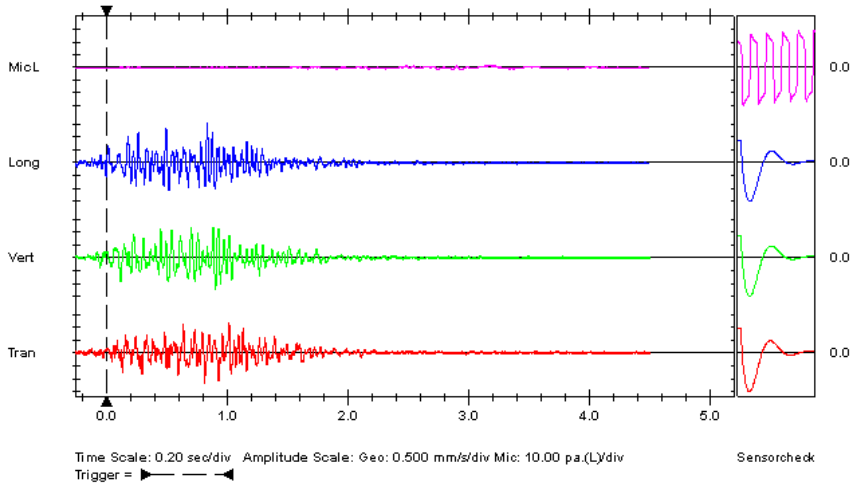

Printed: August 20, 2007 (V 8.01-8.01)

Format Copyrighted 1996-2004 Instantel Inc.

Figure A.13 13th vibration record taken along Gümüüşkol village path.

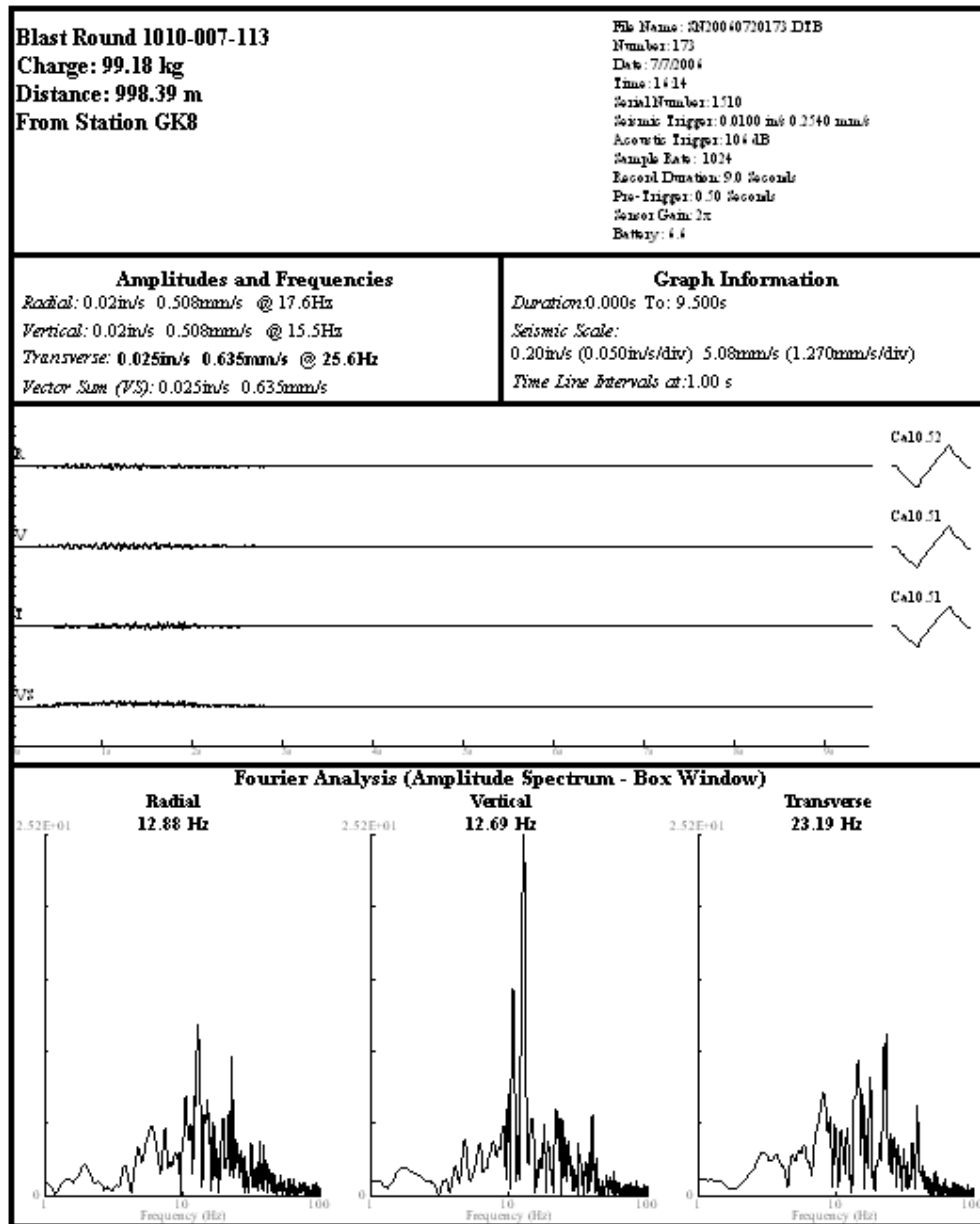

Figure A.14 14th vibration record taken along Gümüüşkol village path.



### Event Report

Date/Time	Tran at 15:09:48 July 11, 2006	Serial Number	BE10317 V 8.01-8.0 MiniMate Plus
Trigger Source	Geo: 0.508 mm/s	Battery Level	6.1 Volts
	Mic: 110 dB(L)	Calibration	June 29, 2005 by Instantel, Inc
Range	Geo :31.7 mm/s	File Name	L317B9EK.SCO
Record Time	5.5 sec (Auto=3Sec) at 2048 sps	Scaled Distance	99.0 (700.0 m, 50.0 kg)
Job Number:	1		

Notes  
Location:  
Client:  
User Name:  
General:

Extended Notes

Post Event Notes

Microphone Linear Weighting  
PSPL 117.2 dB(L) at 2.240 sec  
ZC Freq 51 Hz  
Channel Test Passed (Freq = 20.1 Hz Amp = 469 mv)

	Tran	Vert	Long	
PPV	1.86	2.17	2.80	mm/s
ZC Freq	38	14.6	24	Hz
Time (Rel. to Trig)	1.382	0.928	1.617	sec
Peak Acceleration	0.0762	0.0497	0.0630	g
Peak Displacement	0.0110	0.0211	0.0285	mm
Sensorcheck	Passed	Passed	Passed	
Frequency	7.4	7.2	7.5	Hz
Overswing Ratio	3.4	3.7	3.7	

USBM R18507 And OSMRE

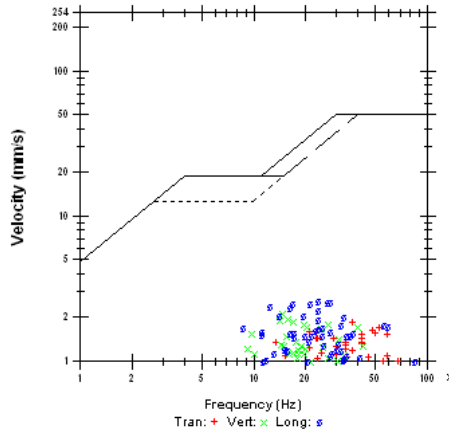

Peak Vector Sum 3.21 mm/s at 1.382 sec

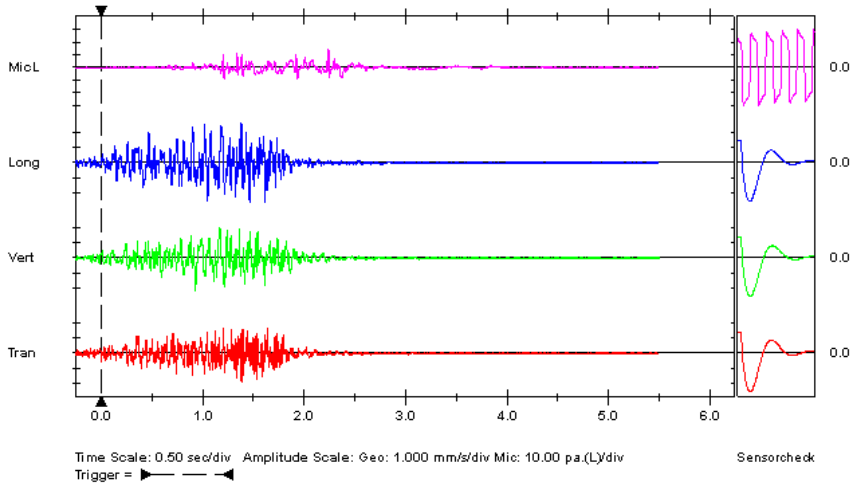

Printed: August 20, 2007 (V 8.01-8.01)

Format Copyrighted 1996-2004 Instantel Inc.

Figure A.15 15th vibration record taken along Gümüşkol village path.



### Event Report

Date/Time	Tran at 15:01:27 July 11, 2006	Serial Number	BE10316 V 8.01-8.0 MiniMate Plus
Trigger Source	Geo: 0.510 mm/s	Battery Level	6.1 Volts
	Mic: 106 dB(L)	Calibration	June 29, 2005 by Instantel, Inc
Range	Geo :31.7 mm/s	File Name	L316B8EK.EFO
Record Time	5.75 sec (Auto=3Sec) at 2048 sps	Scaled Distance	30.0 (300.0 m, 100.0 kg)
Job Number:	1		

**Notes**

Location:  
Client:  
User Name:  
General:

**Extended Notes**

**Post Event Notes**

Microphone Linear Weighting  
 PSPL 107.5 dB(L) at 2.637 sec  
 ZC Freq 49 Hz  
 Channel Test Passed (Freq = 20.1 Hz Amp = 434 mv)

	Tran	Vert	Long	
PPV	1.83	1.83	1.81	mm/s
ZC Freq	23	15.8	11.9	Hz
Time (Rel. to Trig)	1.422	0.934	1.661	sec
Peak Acceleration	0.0365	0.0298	0.0298	g
Peak Displacement	0.0171	0.0172	0.0233	mm
Sensorcheck	Passed	Passed	Passed	
Frequency	7.5	7.4	7.4	Hz
Overswing Ratio	3.6	3.8	3.7	

**USBM R18507 And OSMRE**

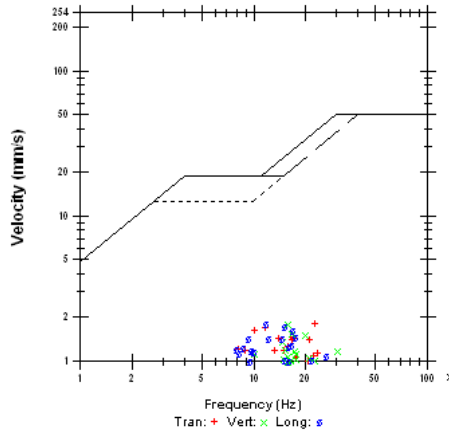

Peak Vector Sum 2.14 mm/s at 1.305 sec

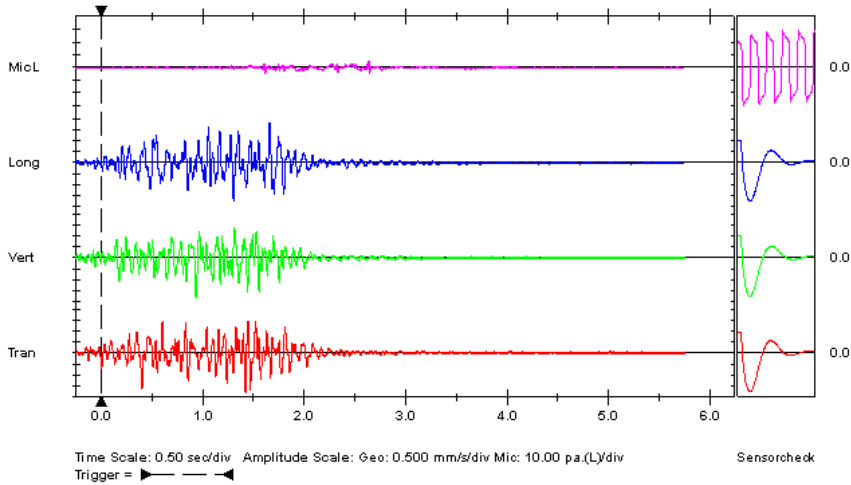

Printed: August 20, 2007 (V 8.01-8.01)

Format Copyrighted 1996-2004 Instantel Inc.

**Figure A.16** 16th vibration record taken along Gümüskol village path.



## Event Report

Date/Time Long at 15:25:07 July 13, 2006  
Trigger Source Geo: 0.508 mm/s  
Range Geo :31.7 mm/s  
Record Time 5.5 sec (Auto=3Sec) at 2048 sps  
Job Number: 1

Serial Number BE10317 V 8.01-8.0 MiniMate Plus  
Battery Level 6.3 Volts  
Calibration June 29, 2005 by Instantel, Inc  
File Name L317B81A.TV0  
Scaled Distance 99.0 (700.0 m, 50.0 kg)

Notes  
Location:  
Client:  
User Name:  
General:

### Extended Notes

Post Event Notes  
13 Temmuz 2006 günü bir delikte 90.32 kg kullanılarak yapılan uretim patlatma yerinden 287.44 m mesafede ocagin hemen uzunden alınan kaydi

Microphone Linear Weighting  
PSPL 119.1 dB(L) at 1.253 sec  
ZC Freq 12.3 Hz  
Channel Test Passed (Freq = 20.1 Hz Amp = 488 mv)

	Tran	Vert	Long	
PPV	7.22	6.18	8.03	mm/s
ZC Freq	32	23	39	Hz
Time (Rel. to Trig)	0.953	0.838	0.942	sec
Peak Acceleration	0.215	0.123	0.232	g
Peak Displacement	0.0428	0.0341	0.0414	mm
Sensorcheck	Passed	Passed	Passed	
Frequency	7.5	7.5	7.4	Hz
Overswing Ratio	3.7	3.9	4.0	

Peak Vector Sum 8.25 mm/s at 0.942 sec

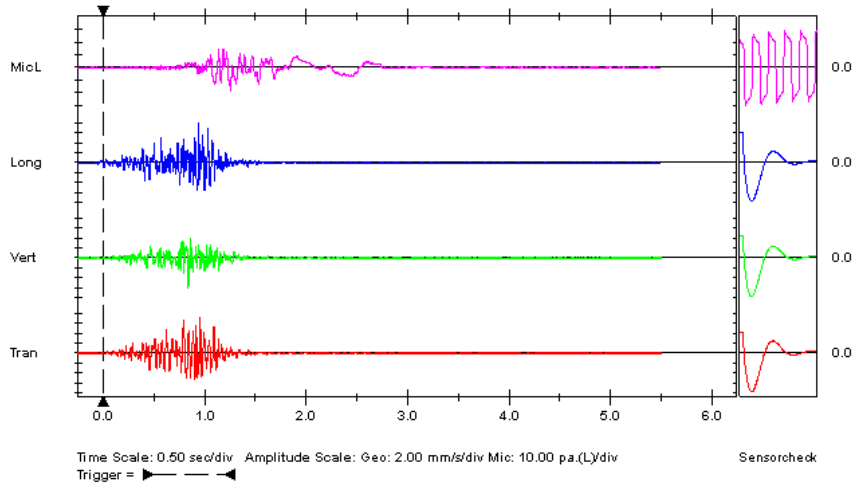

Printed: August 20, 2007 (V 8.01-8.01)

Format Copyrighted 1996-2004 Instantel Inc.

Figure A.17 17th vibration record taken along Gümüüşkol village path.





### Event Report

Date/Time	Tran at 15:25:04 July 13, 2006	Serial Number	BE10316 V 8.01-8.0 MiniMate Plus
Trigger Source	Geo: 0.510 mm/s	Battery Level	6.2 Volts
	Mic: 106 dB(L)	Calibration	June 29, 2005 by Instantel, Inc
Range	Geo :31.7 mm/s	File Name	L316B81A.TS0
Record Time	5.75 sec (Auto=3Sec) at 2048 sps	Scaled Distance	30.0 (300.0 m, 100.0 kg)
Job Number:	1		

Notes  
Location:  
Client:  
User Name:  
General:

Extended Notes

Post Event Notes  
13 Temmuz 2006 günü bir delikte 90.32 kg kullanılarak yapılan uretim patlatma yerinden 481.66 m mesafede Gokgoz Tepesi'nin Gumuskol koyune bakan yuzunde alınan kaydi

Microphone Linear Weighting  
PSPL 108.8 dB(L) at 1.442 sec  
ZC Freq 10.1 Hz  
Channel Test Passed (Freq = 20.1 Hz Amp = 480 mv)

	Tran	Vert	Long	
PPV	4.75	4.60	2.86	mm/s
ZC Freq	19.3	20	24	Hz
Time (Rel. to Trig)	0.590	0.726	0.603	sec
Peak Acceleration	0.0696	0.0663	0.0563	g
Peak Displacement	0.0354	0.0340	0.0209	mm
Sensorcheck	Passed	Passed	Passed	
Frequency	7.3	7.2	7.5	Hz
Overswing Ratio	3.6	3.7	3.6	

#### USBM R18507 And OSMRE

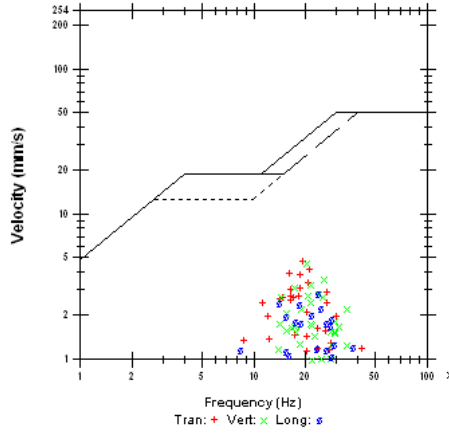

Peak Vector Sum 5.33 mm/s at 0.751 sec

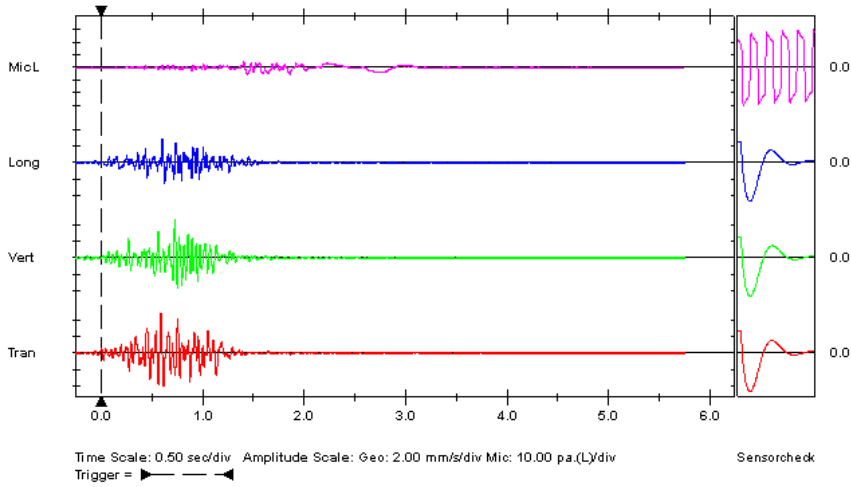

Printed: August 20, 2007 (V 8.01-8.01)

Format Copyrighted 1996-2004 Instantel Inc.

Figure A.18 18th vibration record taken along Gümüskol village path.

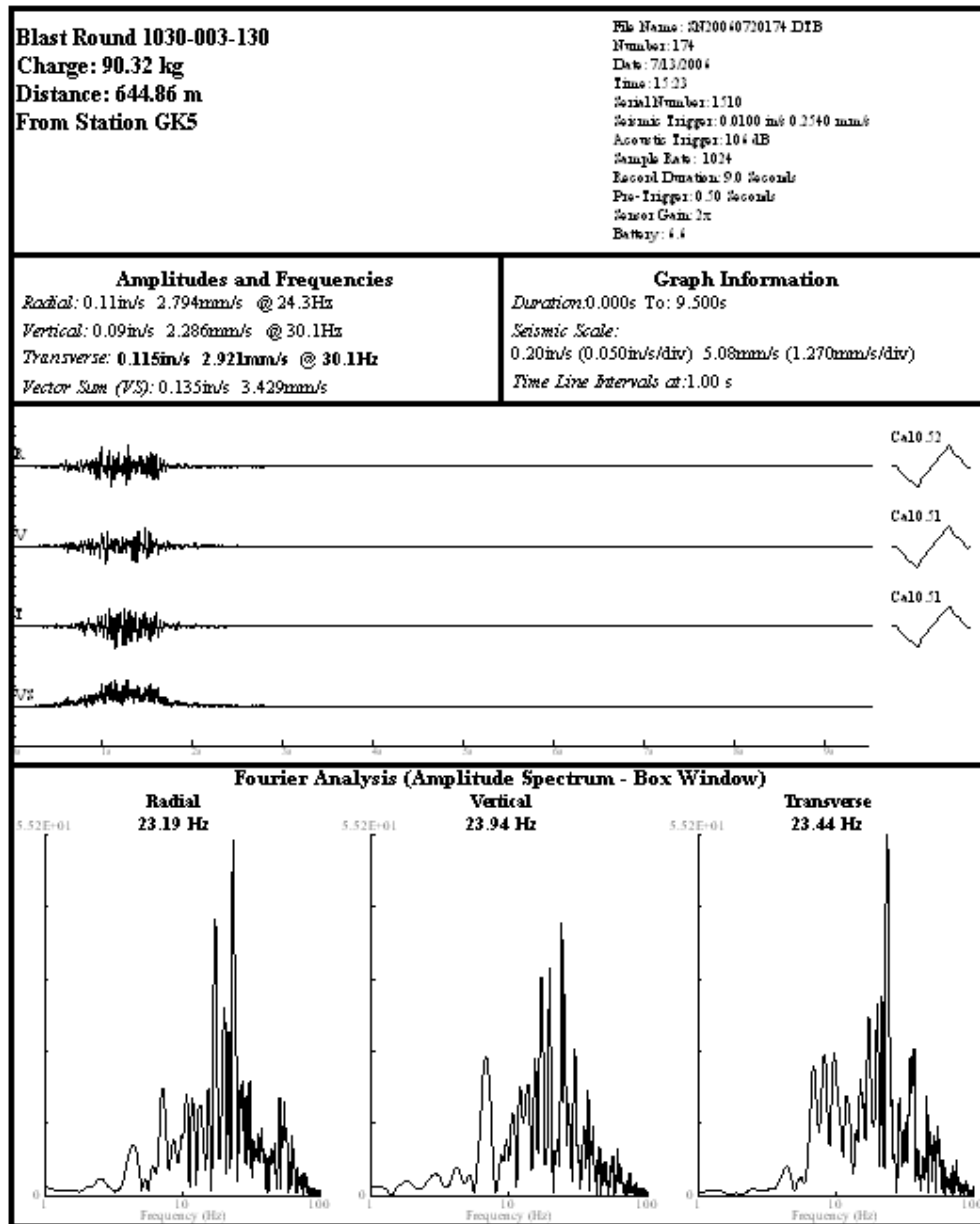

Figure A.19 19th vibration record taken along Gümüüşkol village path.



### Event Report

Date/Time	Vert at 16:54:27 July 14, 2006	Serial Number	BE10317 V 8.01-8.0 MiniMate Plus
Trigger Source	Geo: 0.508 mm/s	Battery Level	6.3 Volts
	Mic: 110 dB(L)	Calibration	June 29, 2005 by Instantel, Inc
Range	Geo :31.7 mm/s	File Name	L317B8K9.MR0
Record Time	4.25 sec (Auto=3Sec) at 2048 sps	Scaled Distance	99.0 (700.0 m, 50.0 kg)
Job Number:	1		

**Notes**

Location:  
Client:  
User Name:  
General:

**Extended Notes**

**Post Event Notes**

Microphone Linear Weighting  
 PSPL 103.5 dB(L) at 1.636 sec  
 ZC Freq 5.0 Hz  
 Channel Test Passed (Freq = 20.1 Hz Amp = 473 mv)

	Tran	Vert	Long	
PPV	2.29	1.64	2.00	mm/s
ZC Freq	12.8	22	13.1	Hz
Time (Rel. to Trig)	0.873	0.548	0.623	sec
Peak Acceleration	0.0365	0.0298	0.0331	g
Peak Displacement	0.0233	0.0158	0.0233	mm
Sensorcheck	Passed	Passed	Passed	
Frequency	7.3	7.2	7.5	Hz
Overswing Ratio	3.5	3.5	3.5	

**USBM R18507 And OSMRE**

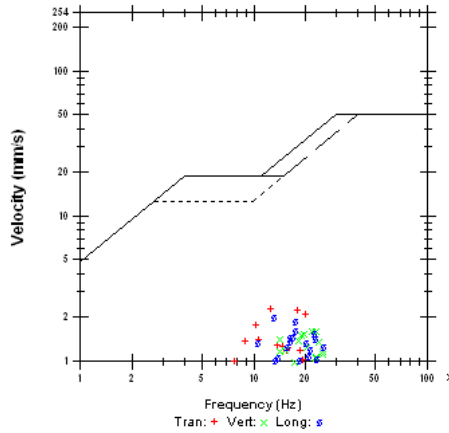

Peak Vector Sum 2.39 mm/s at 0.873 sec

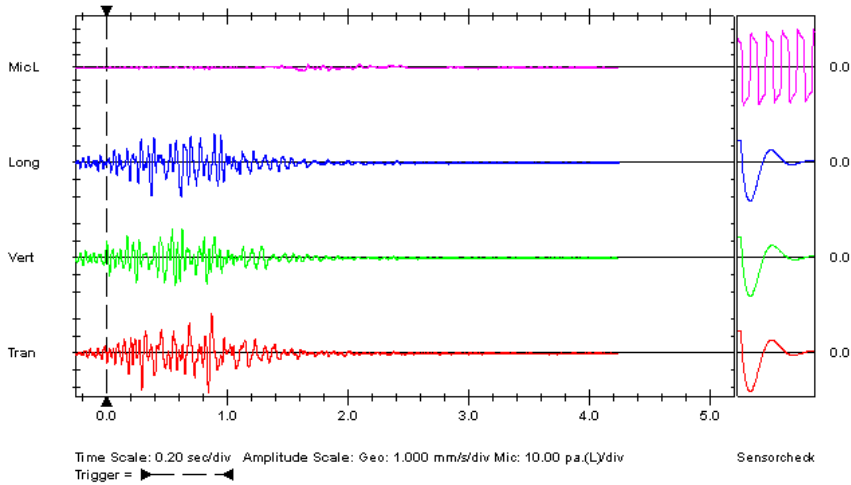

Printed: August 20, 2007 (V 8.01-8.01)

Format Copyrighted 1996-2004 Instantel Inc.

**Figure A.20** 20th vibration record taken along Gümüşkol village path.



### Event Report

Date/Time	Vert at 16:54:27 July 14, 2006	Serial Number	BE10316 V 8.01-8.0 MiniMate Plus
Trigger Source	Geo: 0.510 mm/s	Battery Level	6.2 Volts
	Mic: 106 dB(L)	Calibration	June 29, 2005 by Instantel, Inc
Range	Geo :31.7 mm/s	File Name	L316B8K9.MR0
Record Time	4.25 sec (Auto=3Sec) at 2048 sps	Scaled Distance	30.0 (300.0 m, 100.0 kg)
Job Number:	1		

Notes  
Location:  
Client:  
User Name:  
General:

Extended Notes

Post Event Notes

Microphone Linear Weighting  
PSPL 102.8 dB(L) at 1.850 sec  
ZC Freq 4.6 Hz  
Channel Test Passed (Freq = 20.1 Hz Amp = 477 mv)

	Tran	Vert	Long	
PPV	1.60	1.21	1.71	mm/s
ZC Freq	24	24	26	Hz
Time (Rel. to Trig)	0.613	0.740	0.392	sec
Peak Acceleration	0.0365	0.0298	0.0365	g
Peak Displacement	0.0120	0.0102	0.0111	mm
Sensorcheck	Passed	Passed	Passed	
Frequency	7.5	7.4	7.4	Hz
Overswing Ratio	3.7	3.8	3.7	

USBM R18507 And OSMRE

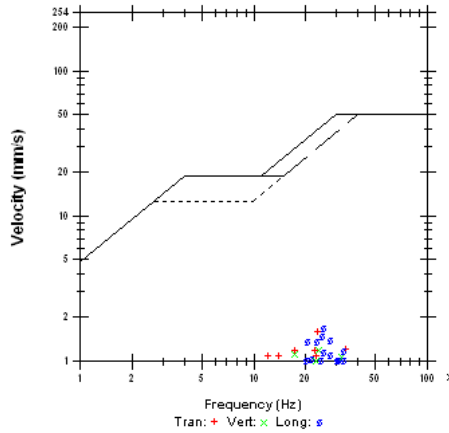

Peak Vector Sum 1.87 mm/s at 0.613 sec

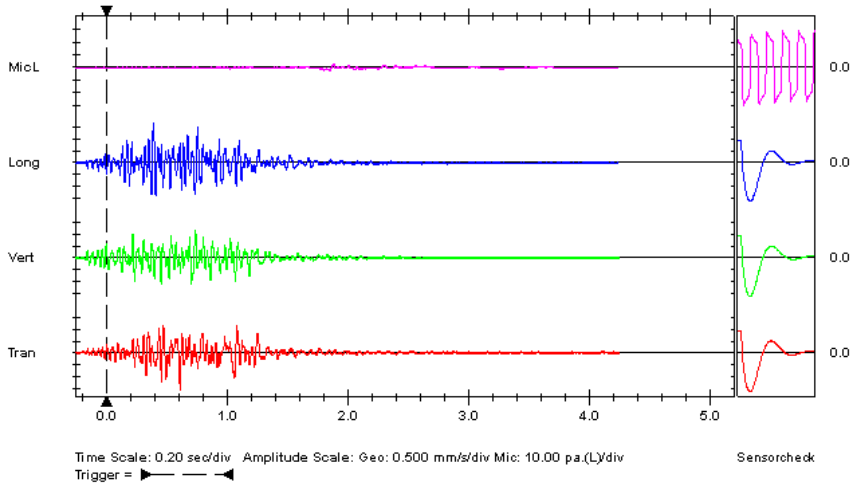

Printed: August 20, 2007 (V 8.01-8.01)

Format Copyrighted 1996-2004 Instantel Inc.

Figure A.21 21st vibration record taken along Gümüskol village path.

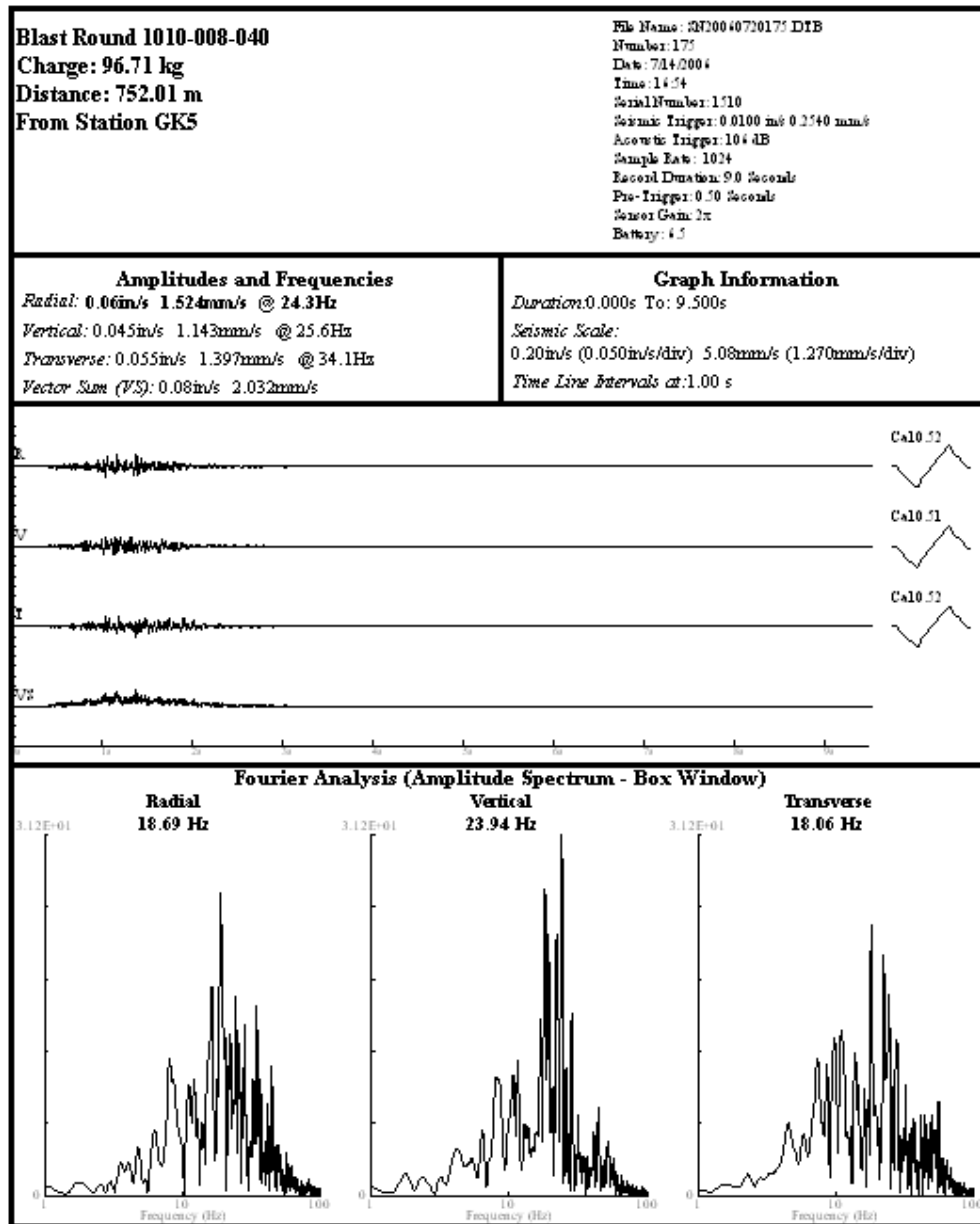

Figure A.22 22nd vibration record taken along Gümüşkol village path.

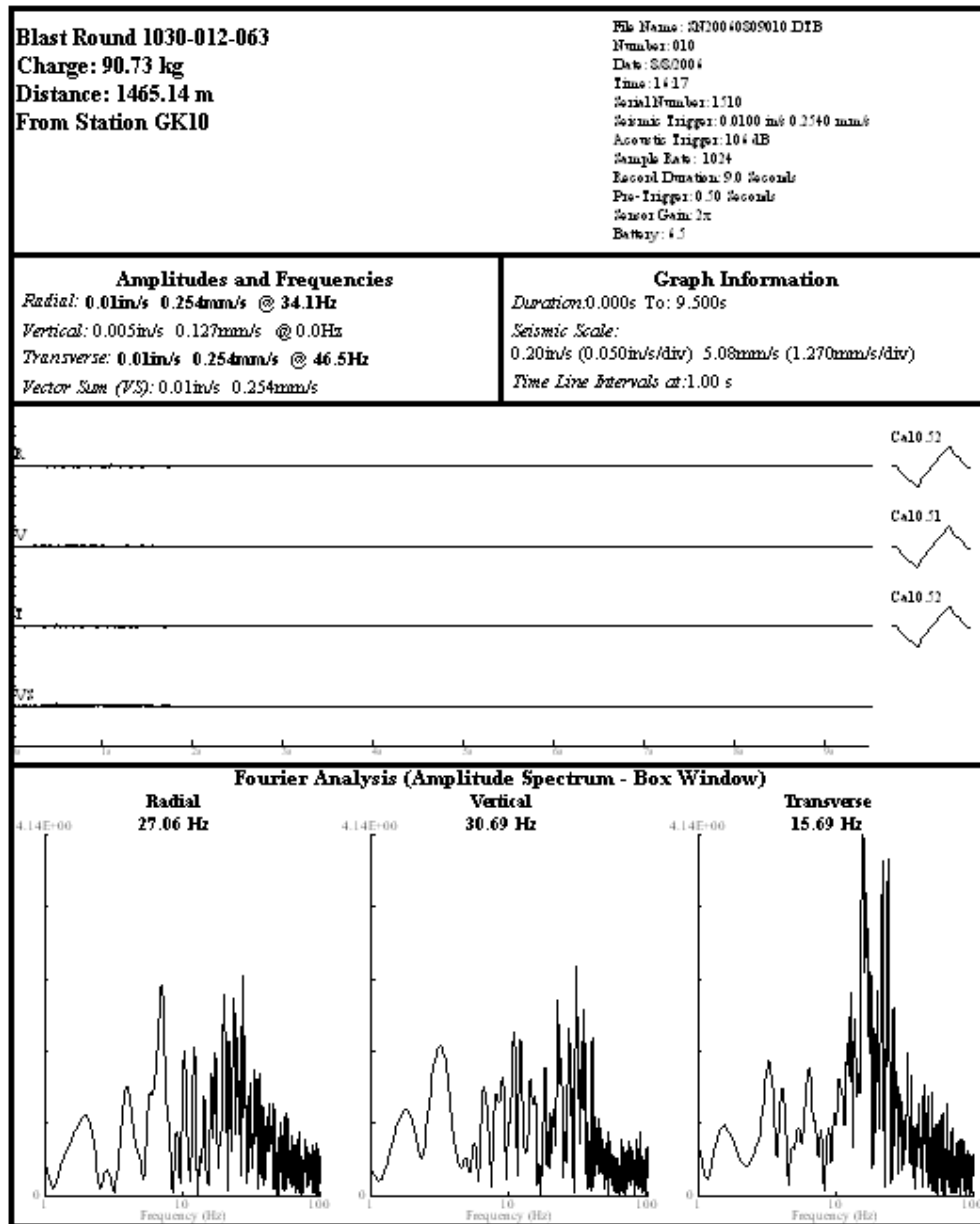
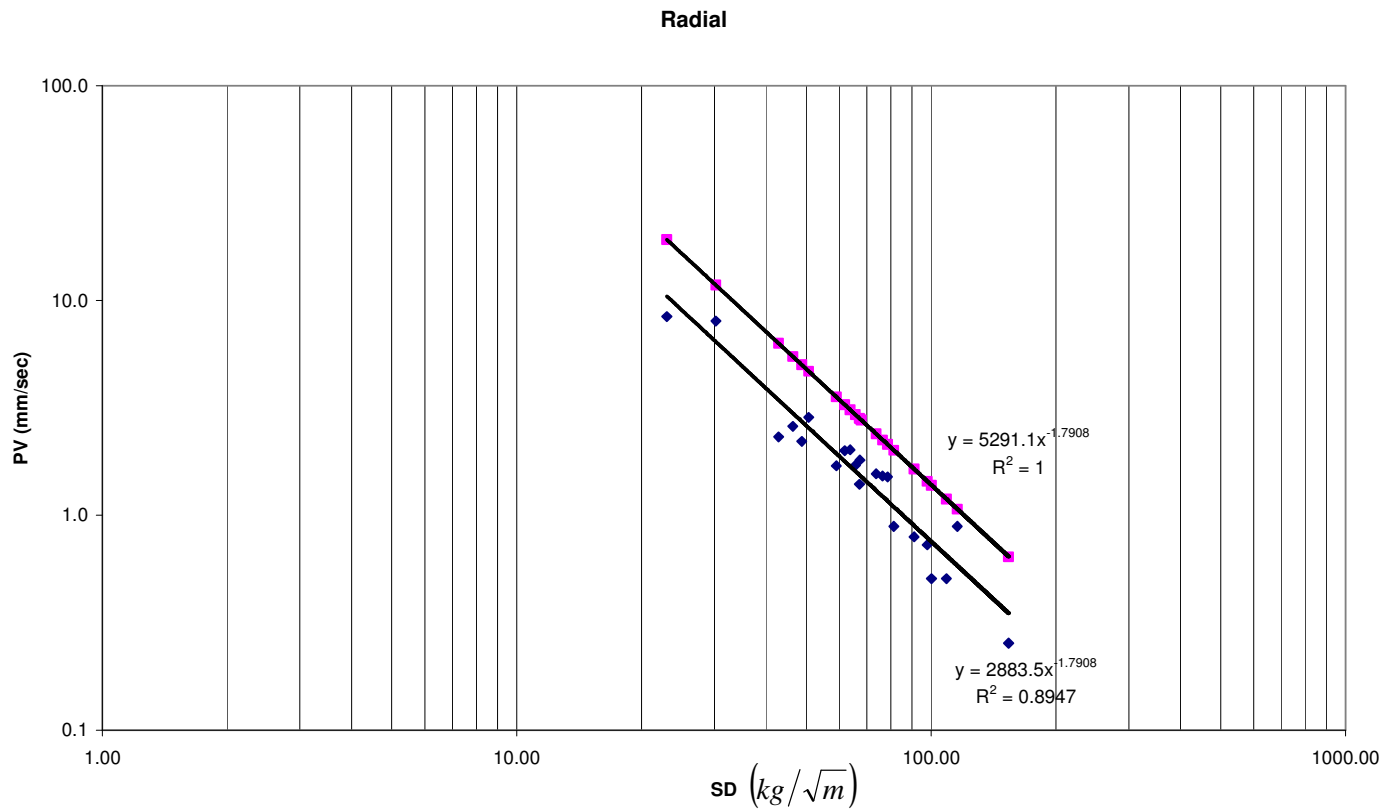
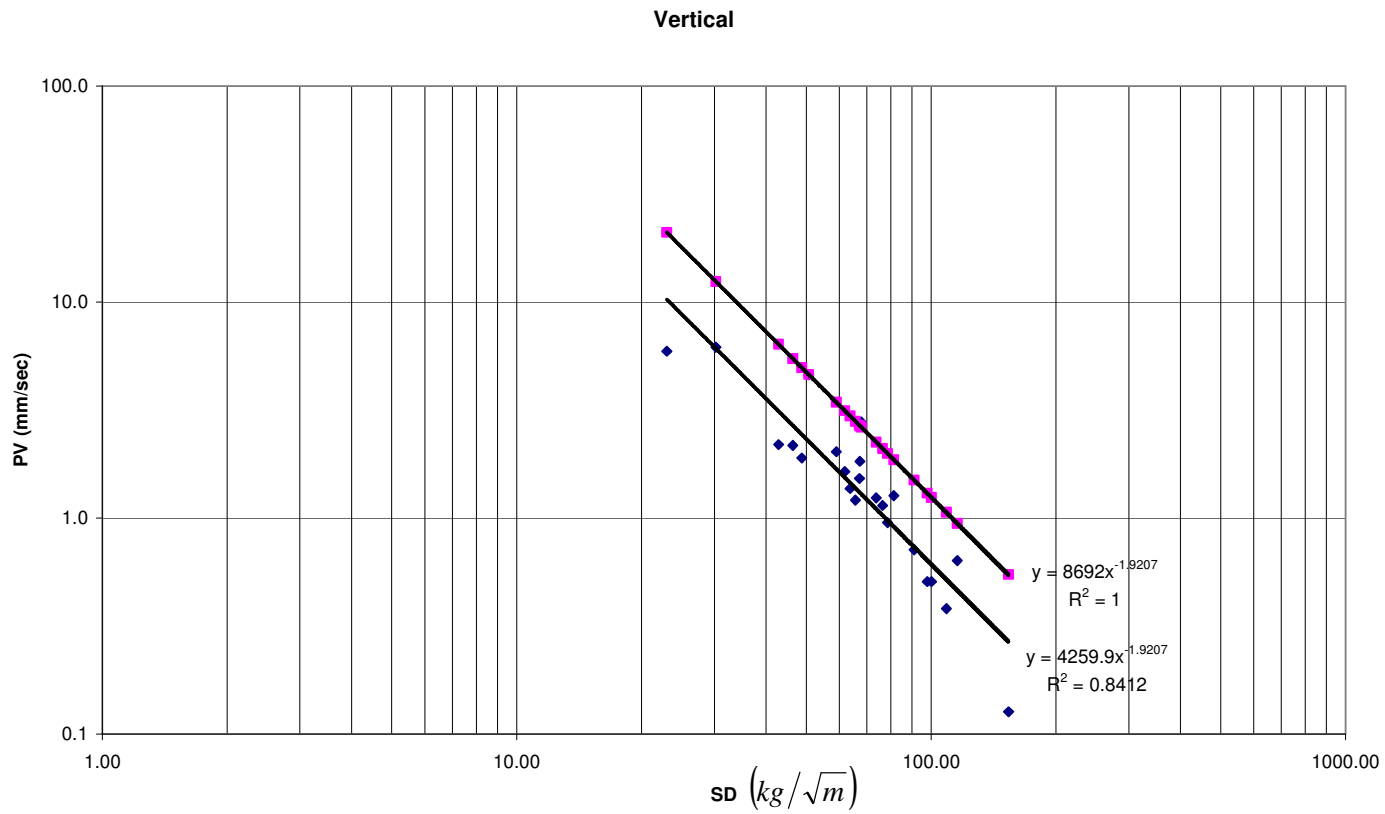

Figure A.23 23rd vibration record taken along Gümüŝkol village path.

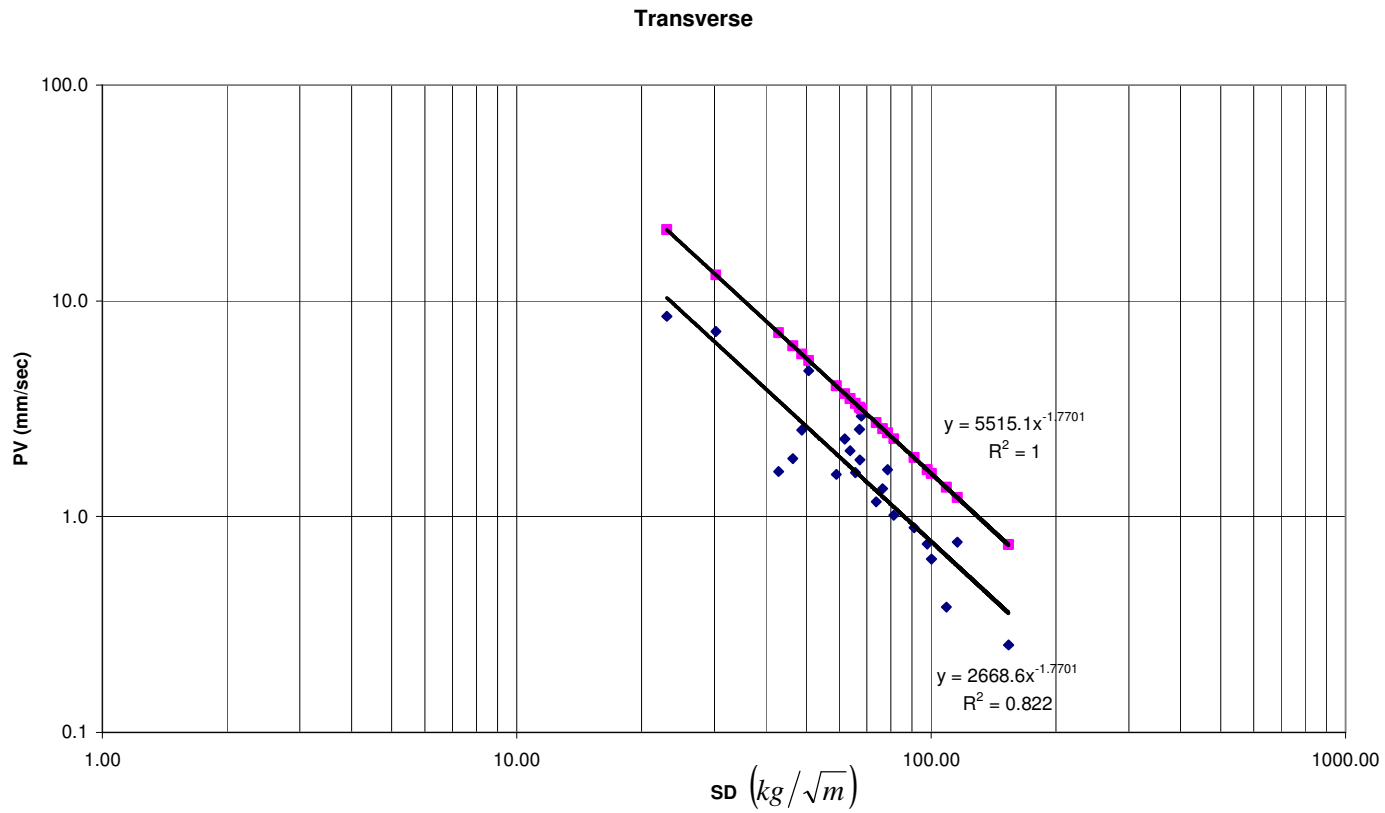

**Figure B.1** Scaled distance (SD) – particle velocity (PV) relation measured in longitudinal (R) component along Gümüşkol Village path

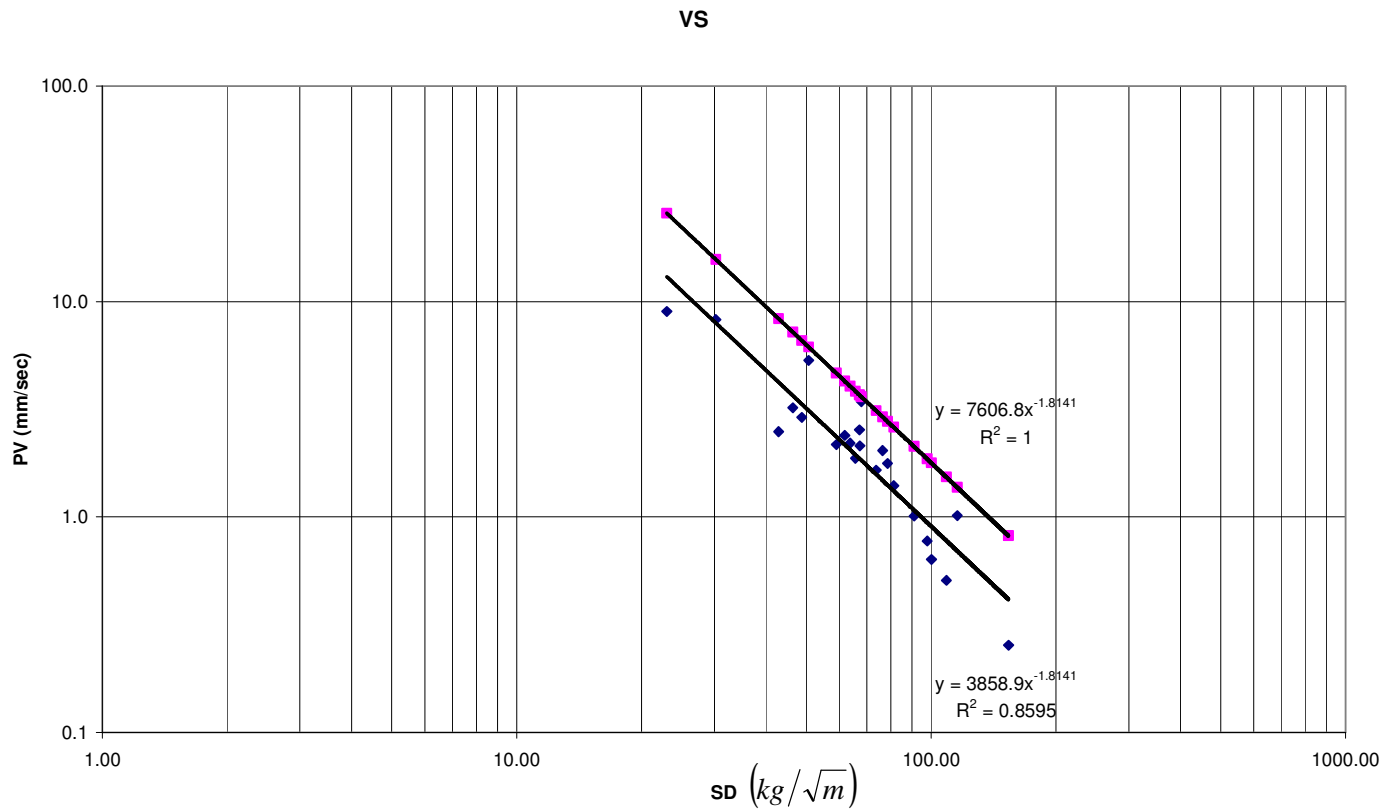

**Figure B.2** Scaled distance (SD) – particle velocity (PV) relation measured in vertical (V) component along Gümüşkol Village path

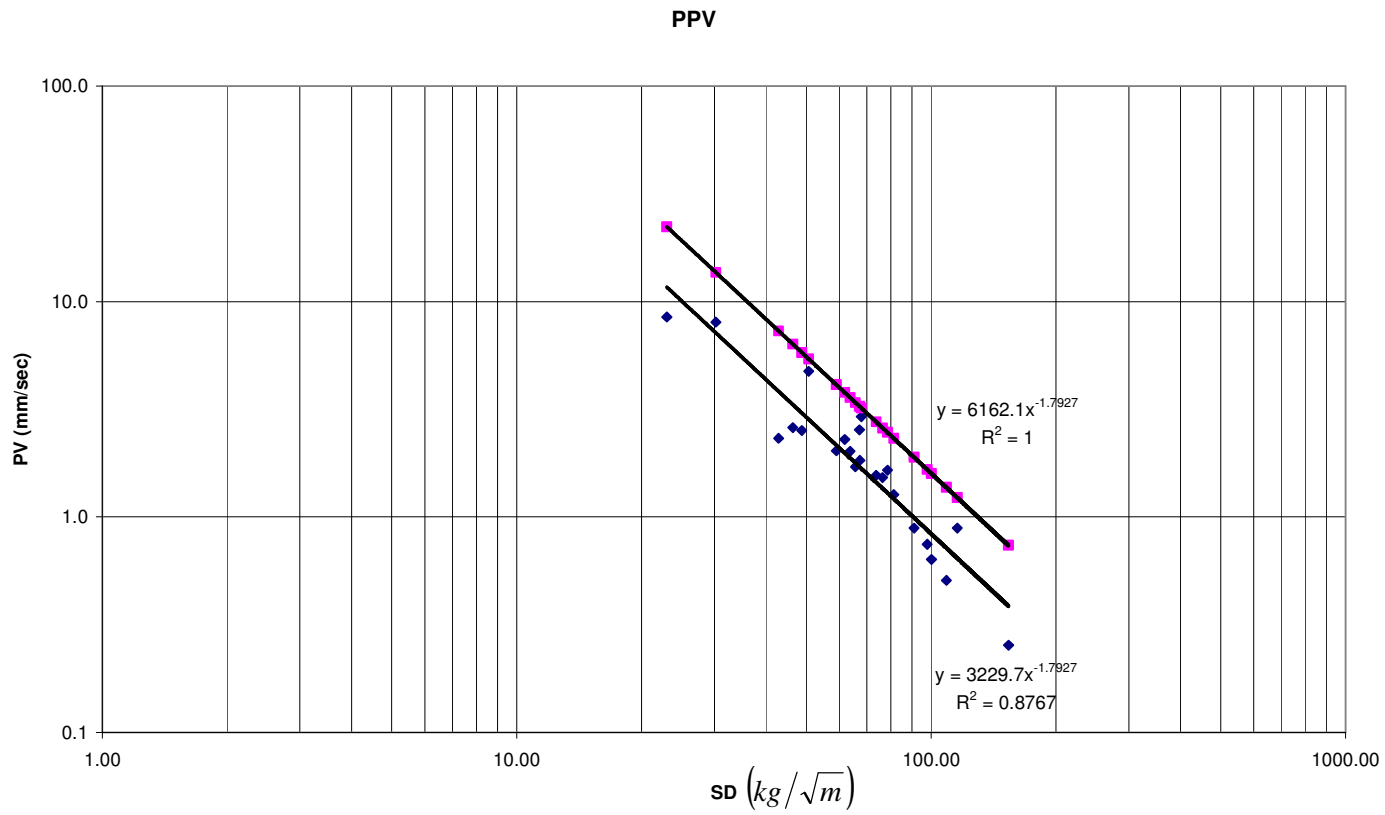



**Figure B.3** Scaled distance (SD) – particle velocity (PV) relation measured in transverse (T) component along Gümüşkol Village path



**Figure B.4** Scaled distance (SD) – particle velocity (PV) relation measured as vector sum (VS) along Gümüşkol Village path



**Figure B.5** Scaled distance (SD) – peak particle velocity (PPV) relation measured along Gümüşkol Village path

## APPENDIX C

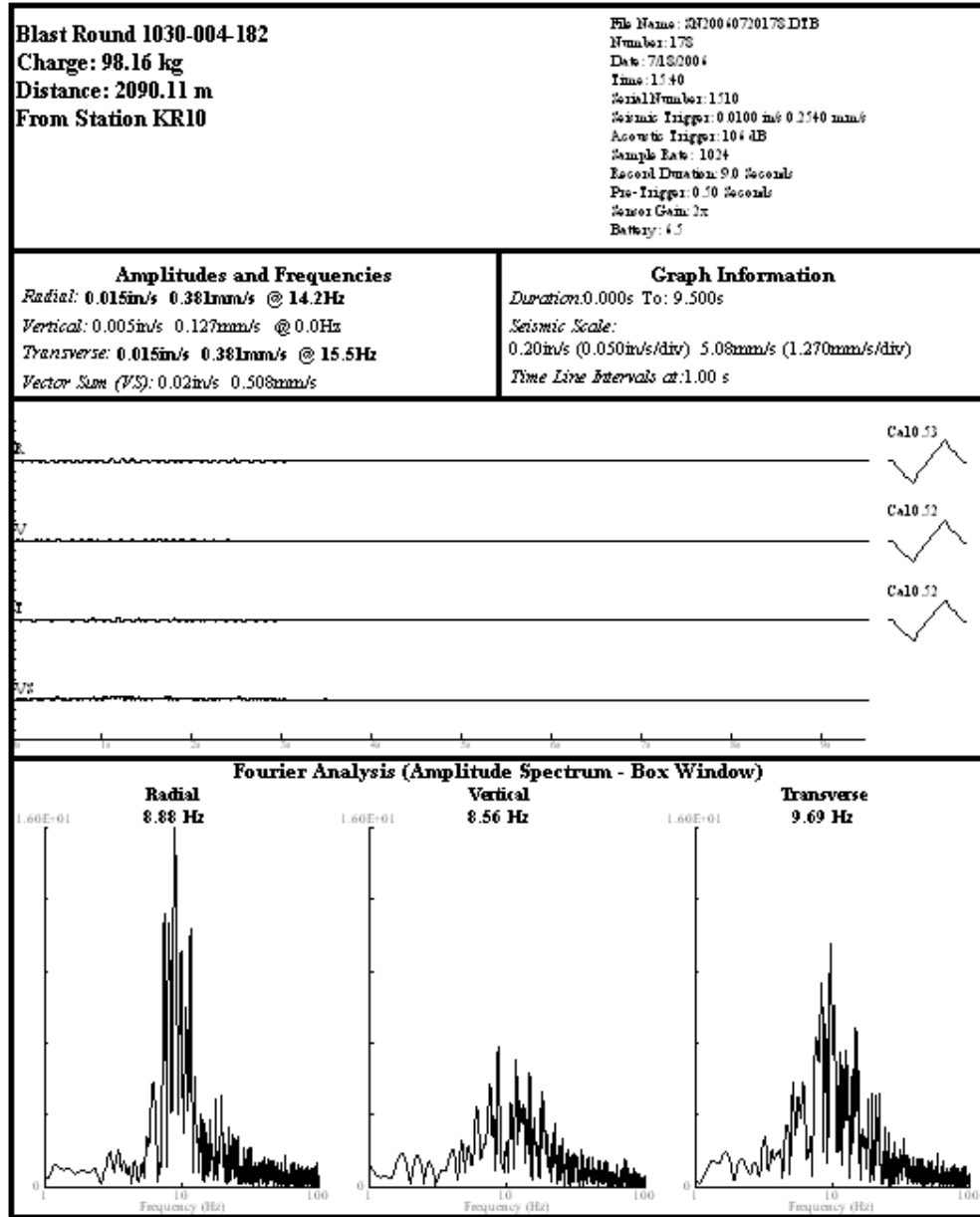

Figure C.1 1st vibration record taken along Karapınar District path.

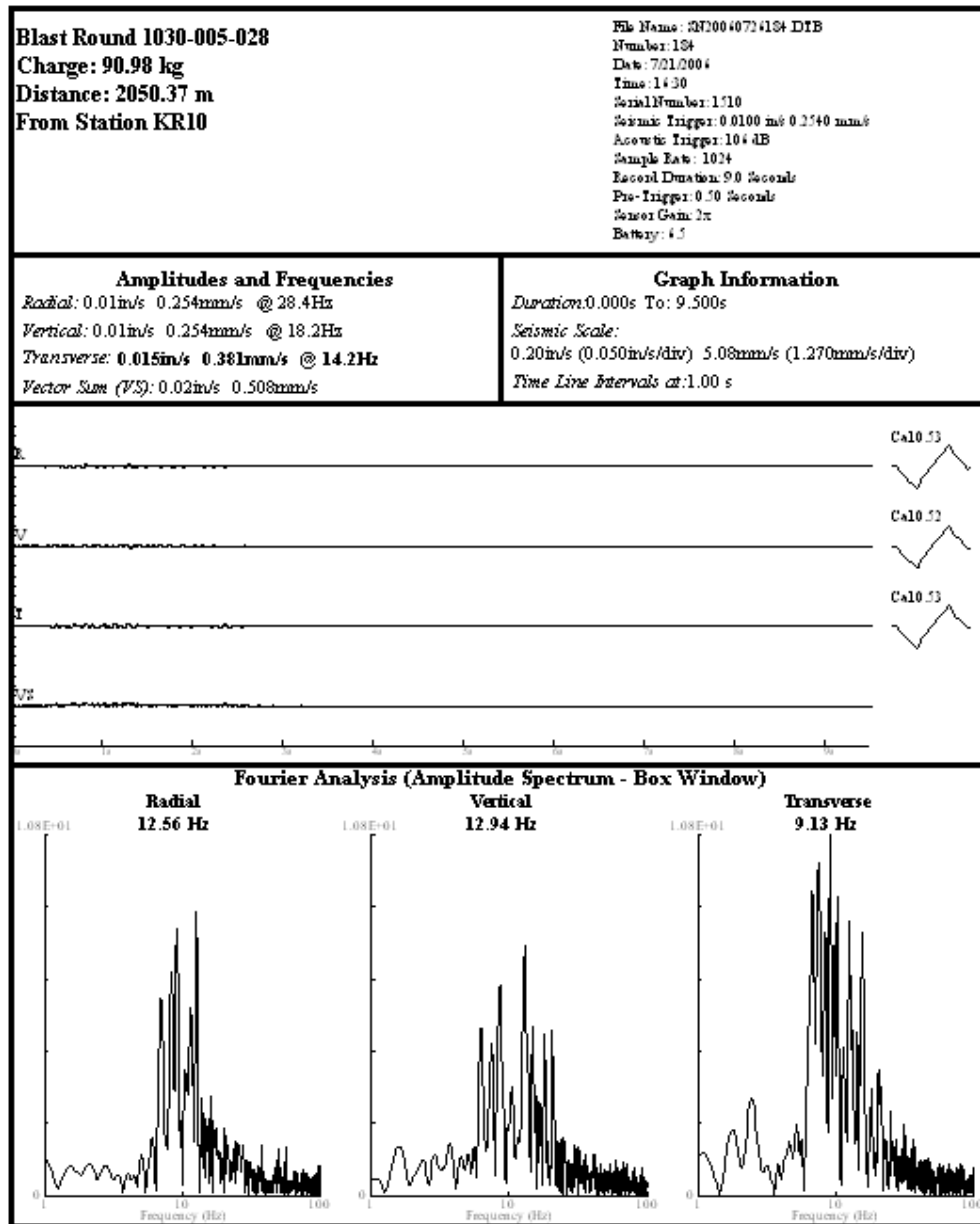

Figure C.2 2nd vibration record taken along Karapınar District path.



### Event Report

Date/Time Long at 16:11:23 July 25, 2006  
 Trigger Source Geo: 0.508 mm/s  
 Range Geo: 31.7 mm/s  
 Record Time 4.25 sec (Auto=3Sec) at 2048 sps  
 Job Number: 1

Serial Number BE10317 V 8.01-8.0 MiniMate Plus  
 Battery Level 6.1 Volts  
 Calibration June 29, 2005 by Instantel, Inc  
 File Name L317B94K.Y2D  
 Scaled Distance 99.0 (700.0 m, 50.0 kg)

Notes  
 Location:  
 Client:  
 User Name:  
 General:

Extended Notes

Post Event Notes

Microphone Linear Weighting  
 PSPL 104.9 dB(L) at 1.992 sec  
 ZC Freq 13.7 Hz  
 Channel Test Passed (Freq = 20.1 Hz Amp = 477 mv)

	Tran	Vert	Long	
PPV	1.37	0.921	1.32	mm/s
ZC Freq	20	26	22	Hz
Time (Rel. to Trig)	0.443	0.131	0.670	sec
Peak Acceleration	0.0298	0.0232	0.0232	g
Peak Displacement	0.0105	0.00596	0.00997	mm
Sensorcheck	Passed	Passed	Passed	
Frequency	7.4	7.2	7.5	Hz
Overswing Ratio	3.5	3.7	3.6	

Peak Vector Sum 1.60 mm/s at 0.443 sec

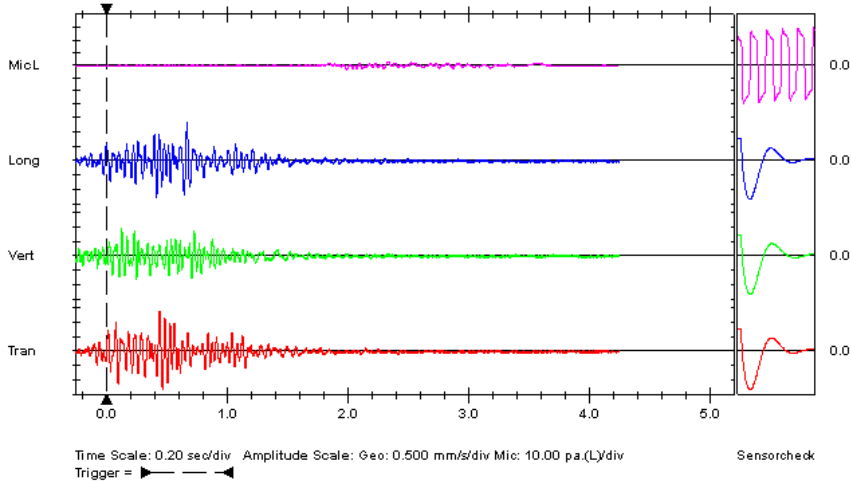
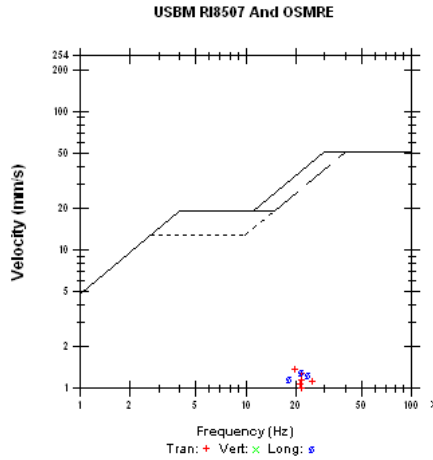

Printed: August 20, 2007 (V 8.01 - 8.01)

Format Copyrighted 1996-2004 Instantel Inc.

**Figure C.3** 3rd vibration record taken along Karapınar District path.



### Event Report

Date/Time	Tran at 16:11:02 July 25, 2006	Serial Number	BE10316 V 8.01-8.0 MiniMate Plus
Trigger Source	Geo: 0.510 mm/s	Battery Level	6.0 Volts
	Mic: 106 dB(L)	Calibration	June 29, 2005 by Instantel, Inc
Range	Geo :31.7 mm/s	File Name	L316B94K.YE0
Record Time	3.25 sec (Auto=3Sec) at 2048 sps	Scaled Distance	30.0 (300.0 m, 100.0 kg)
Job Number:	1		

Notes  
Location:  
Client:  
User Name:  
General:

Extended Notes

Post Event Notes

Microphone Linear Weighting  
PSPL 101.0 dB(L) at 2.524 sec  
ZC Freq 19.3 Hz  
Channel Test Passed (Freq = 20.1 Hz Amp = 445 mv)

	Tran	Vert	Long	
PPV	0.714	0.508	0.571	mm/s
ZC Freq	26	23	19.7	Hz
Time (Rel. to Trig)	0.200	0.099	0.110	sec
Peak Acceleration	0.0166	0.0166	0.0133	g
Peak Displacement	0.00448	0.00356	0.00430	mm
Sensorcheck	Passed	Passed	Passed	
Frequency	7.5	7.5	7.3	Hz
Overswing Ratio	3.6	3.7	3.8	

USBM R18507 And OSMRE

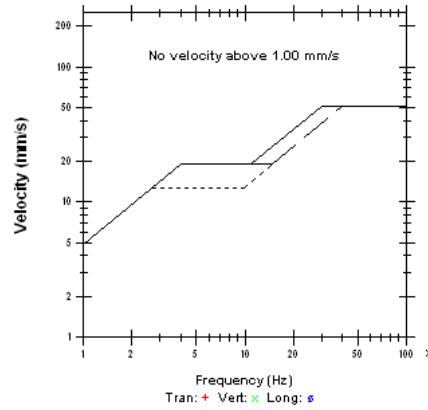

Peak Vector Sum 0.716 mm/s at 0.201 sec

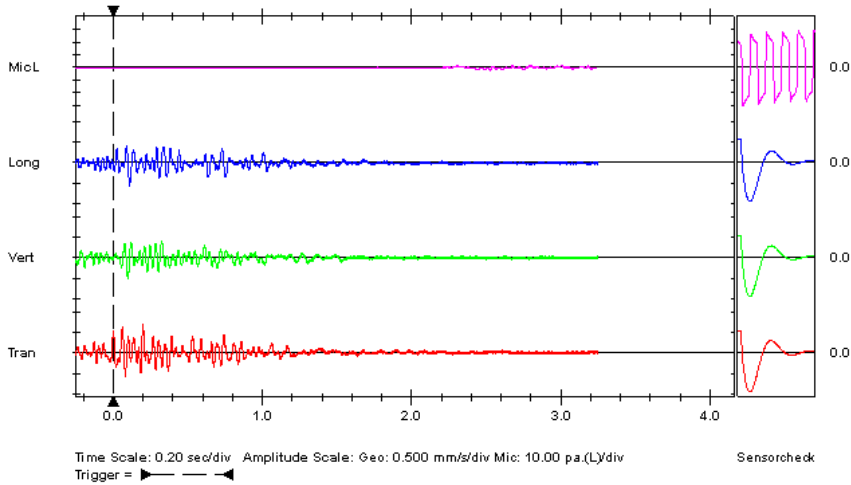

Printed: August 20, 2007 (V 8.01-8.01)

Format Copyrighted 1996-2004 Instantel Inc.

Figure C.4 4th vibration record taken along Karapınar District path.

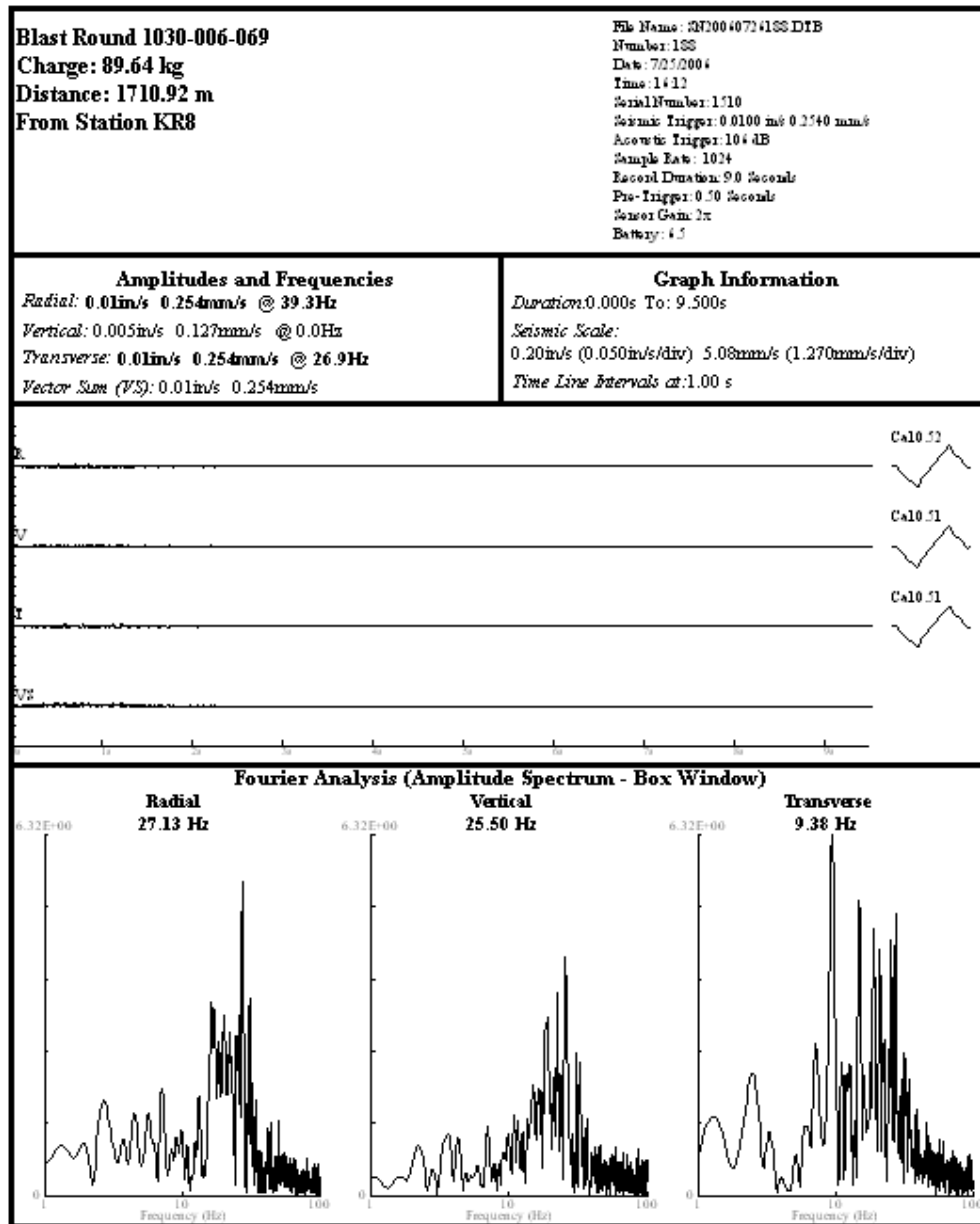

Figure C.5 5th vibration record taken along Karapinar District path.





## Event Report

Date/Time	Vert at 16:09:49 July 28, 2006	Serial Number	BE10317 V 8.01-8.0 MiniMate Plus
Trigger Source	Geo: 0.508 mm/s	Battery Level	6.1 Volts
	Mic: 110 dB(L)	Calibration	June 29, 2005 by Instantel, Inc
Range	Geo :31.7 mm/s	File Name	L317B9A4.WDD
Record Time	3.75 sec (Auto=3Sec) at 2048 sps	Scaled Distance	99.0 (700.0 m, 50.0 kg)
Job Number:	1		

Notes  
Location:  
Client:  
User Name:  
General:

Extended Notes

Post Event Notes

Microphone Linear Weighting  
PSPL 106.0 dB(L) at 2.311 sec  
ZC Freq 4.0 Hz  
Channel Test Passed (Freq = 20.1 Hz Amp = 419 mv)

	Tran	Vert	Long	
PPV	0.873	0.667	0.730	mm/s
ZC Freq	25	28	23	Hz
Time (Rel. to Trig)	0.559	0.445	0.305	sec
Peak Acceleration	0.0199	0.0199	0.0199	g
Peak Displacement	0.00540	0.00440	0.00496	mm
Sensorcheck	Passed	Passed	Passed	
Frequency	7.5	7.3	7.6	Hz
Overswing Ratio	3.4	3.6	3.5	

USBM R18507 And OSMRE

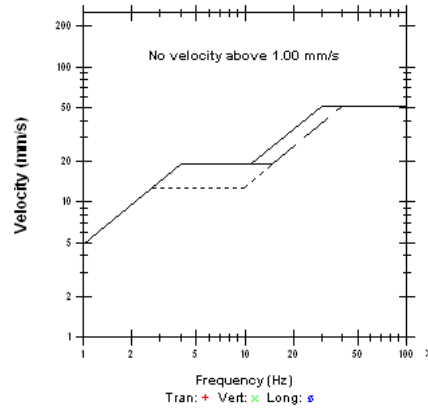

Peak Vector Sum 0.910 mm/s at 0.560 sec

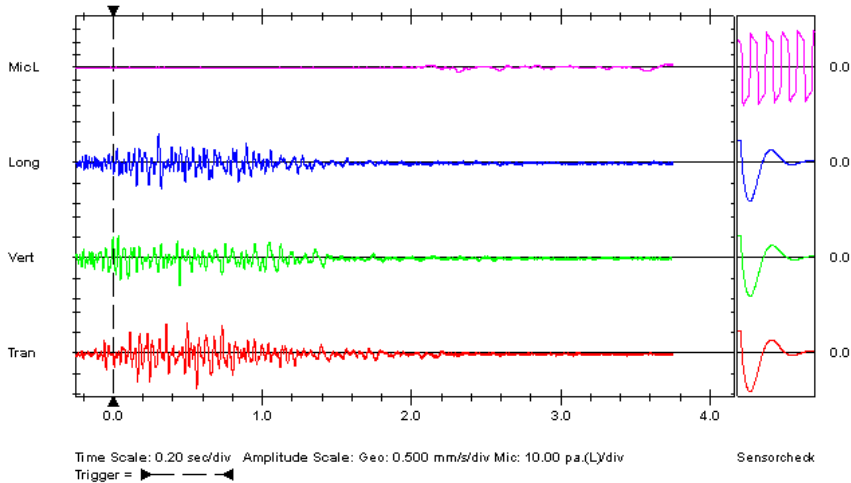

Figure C.6 6th vibration record taken along Karapinar District path.



## Event Report

Date/Time	Tran at 16:09:22 July 28, 2006	Serial Number	BE10316 V 8.01-8.0 MiniMate Plus
Trigger Source	Geo: 0.510 mm/s	Battery Level	6.0 Volts
	Mic: 106 dB(L)	Calibration	June 29, 2005 by Instantel, Inc
Range	Geo :31.7 mm/s	File Name	L316B9A4.VM0
Record Time	3.25 sec (Auto=3Sec) at 2048 sps	Scaled Distance	30.0 (300.0 m, 100.0 kg)
Job Number:	1		

Notes  
Location:  
Client:  
User Name:  
General:

Extended Notes

Post Event Notes

Microphone Linear Weighting  
PSPL 102.8 dB(L) at 2.554 sec  
ZC Freq 3.7 Hz  
Channel Test Passed (Freq = 20.1 Hz Amp = 491 mv)

	Tran	Vert	Long	
PPV	0.714	0.429	0.460	mm/s
ZC Freq	27	25	28	Hz
Time (Rel. to Trig)	0.004	0.021	0.092	sec
Peak Acceleration	0.0166	0.0133	0.0166	g
Peak Displacement	0.00415	0.00326	0.00374	mm
Sensorcheck	Passed	Passed	Passed	
Frequency	7.5	7.5	7.4	Hz
Overswing Ratio	3.6	3.7	3.8	

Peak Vector Sum 0.815 mm/s at 0.004 sec

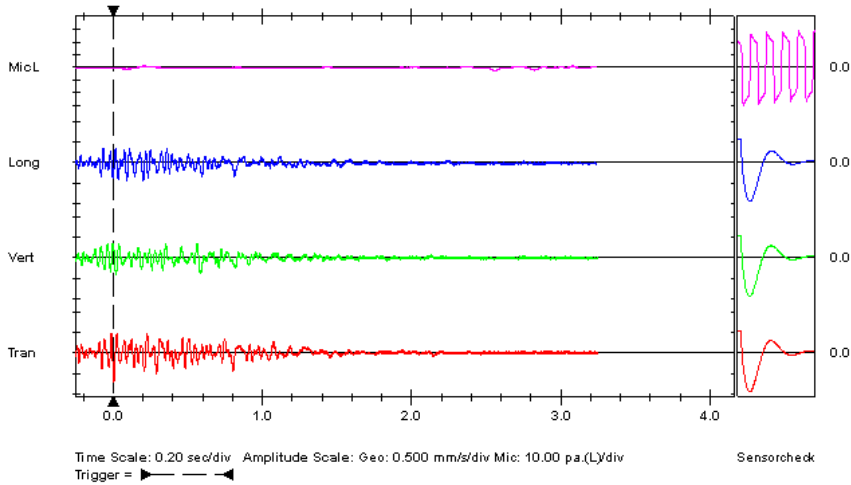

Figure C.7 7th vibration record taken along Karapınar District path.

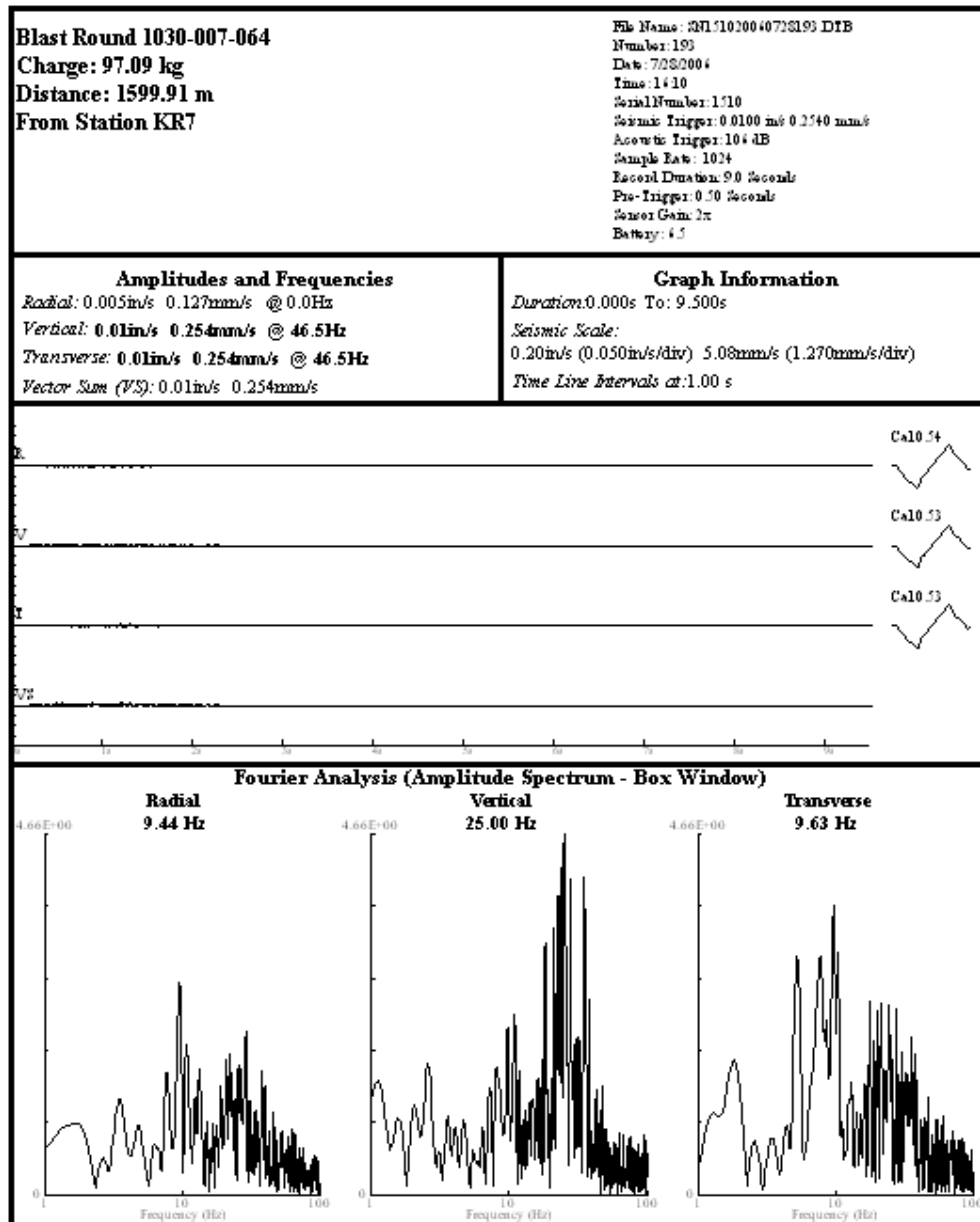

Figure C.8 8th vibration record taken along Karapinar District path.



## Event Report

Date/Time	Vert at 16:39:07 July 31, 2006	Serial Number	BE10317 V 8.01-8.0 MiniMate Plus
Trigger Source	Geo: 0.508 mm/s	Battery Level	6.3 Volts
	Mic: 110 dB(L)	Calibration	June 29, 2005 by Instantel, Inc
Range	Geo :31.7 mm/s	File Name	L317B9FQ.970
Record Time	5.75 sec (Auto=3Sec) at 2048 sps	Scaled Distance	99.0 (700.0 m, 50.0 kg)
Job Number:	1		

### Notes

Location:  
Client:  
User Name:  
General:

### Extended Notes

### Post Event Notes

Microphone Linear Weighting  
 PSPL 110.6 dB(L) at 2.357 sec  
 ZC Freq 1.5 Hz  
 Channel Test Passed (Freq = 20.5 Hz Amp = 475 mv)

	Tran	Vert	Long	
PPV	1.43	1.14	1.97	mm/s
ZC Freq	19.0	15.1	16.5	Hz
Time (Rel. to Trig)	0.657	0.381	0.756	sec
Peak Acceleration	0.0232	0.0232	0.0298	g
Peak Displacement	0.0148	0.0102	0.0181	mm
Sensorcheck	Passed	Passed	Passed	
Frequency	7.4	7.2	7.7	Hz
Overswing Ratio	3.5	3.6	3.5	

### USBM R18507 And OSMRE

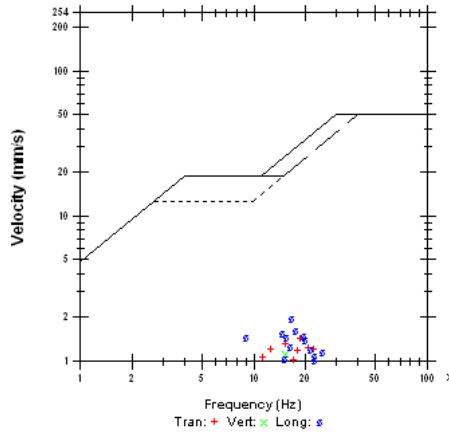

Peak Vector Sum 2.00 mm/s at 0.756 sec

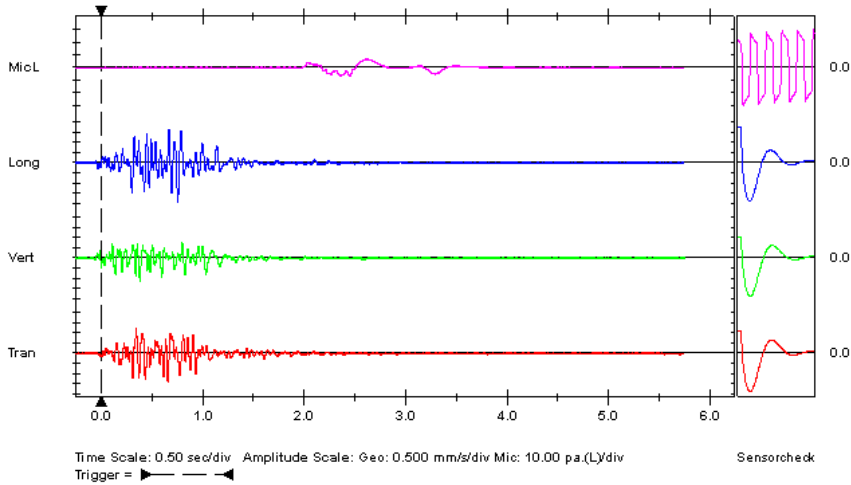

Printed: August 20, 2007 (V 8.01 - 8.01)

Format Copyrighted 1996-2004 Instantel Inc.

Figure C.9 9th vibration record taken along Karapınar District path.



### Event Report

Date/Time Tran at 16:38:34 July 31, 2006  
 Trigger Source Geo: 0.510 mm/s  
 Range Geo :31.7 mm/s  
 Record Time 3.5 sec (Auto=3Sec) at 2048 sps  
 Job Number: 1

Serial Number BE10316 V 8.01-8.0 MiniMate Plus  
 Battery Level 6.0 Volts  
 Calibration June 29, 2005 by Instantel Inc  
 File Name L316B9FG.8AO  
 Scaled Distance 30.0 (300.0 m, 100.0 kg)

Notes  
 Location:  
 Client:  
 User Name:  
 General:

Extended Notes

Post Event Notes

Microphone Linear Weighting  
 PSPL 98.8 dB(L) at 3.490 sec  
 ZC Freq N/A  
 Channel Test Passed (Freq = 20.1 Hz Amp = 470 mv)

	Tran	Vert	Long	
PPV	0.714	0.270	0.349	mm/s
ZC Freq	12.5	15.5	15.3	Hz
Time (Rel. to Trig)	0.293	-0.044	-0.064	sec
Peak Acceleration	0.0133	0.0133	0.0166	g
Peak Displacement	0.00819	0.00288	0.00391	mm
Sensorcheck	Passed	Passed	Passed	
Frequency	7.6	7.5	7.3	Hz
Overswing Ratio	3.6	3.8	3.9	

Peak Vector Sum 0.750 mm/s at 0.297 sec

N/A: Not Applicable

USBM R18507 And OSMRE

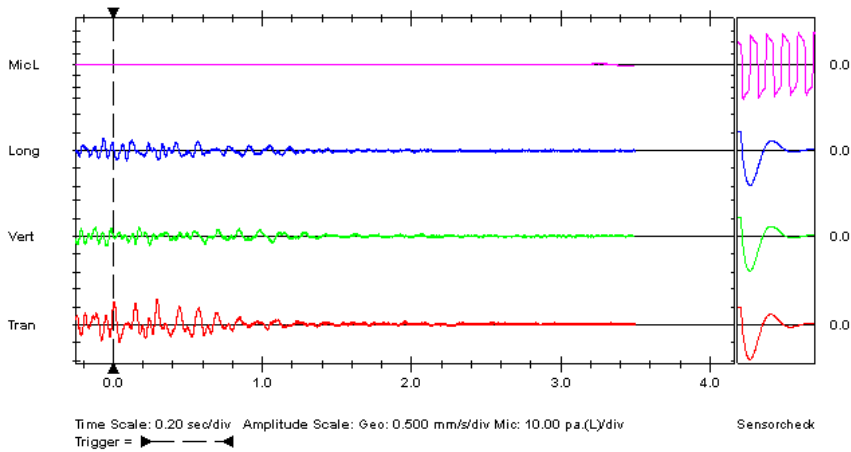
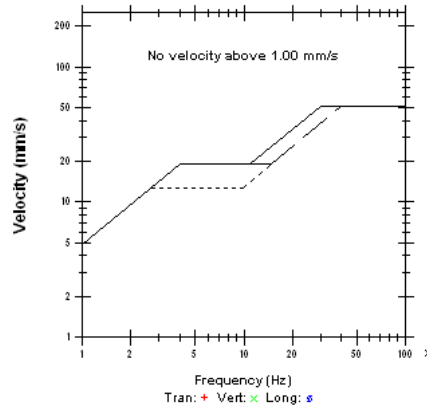

Printed: August 20, 2007 (V 8.01-8.01)

Format Copyrighted 1996-2004 Instantel Inc.

Figure C.10 10th vibration record taken along Karapınar District path.

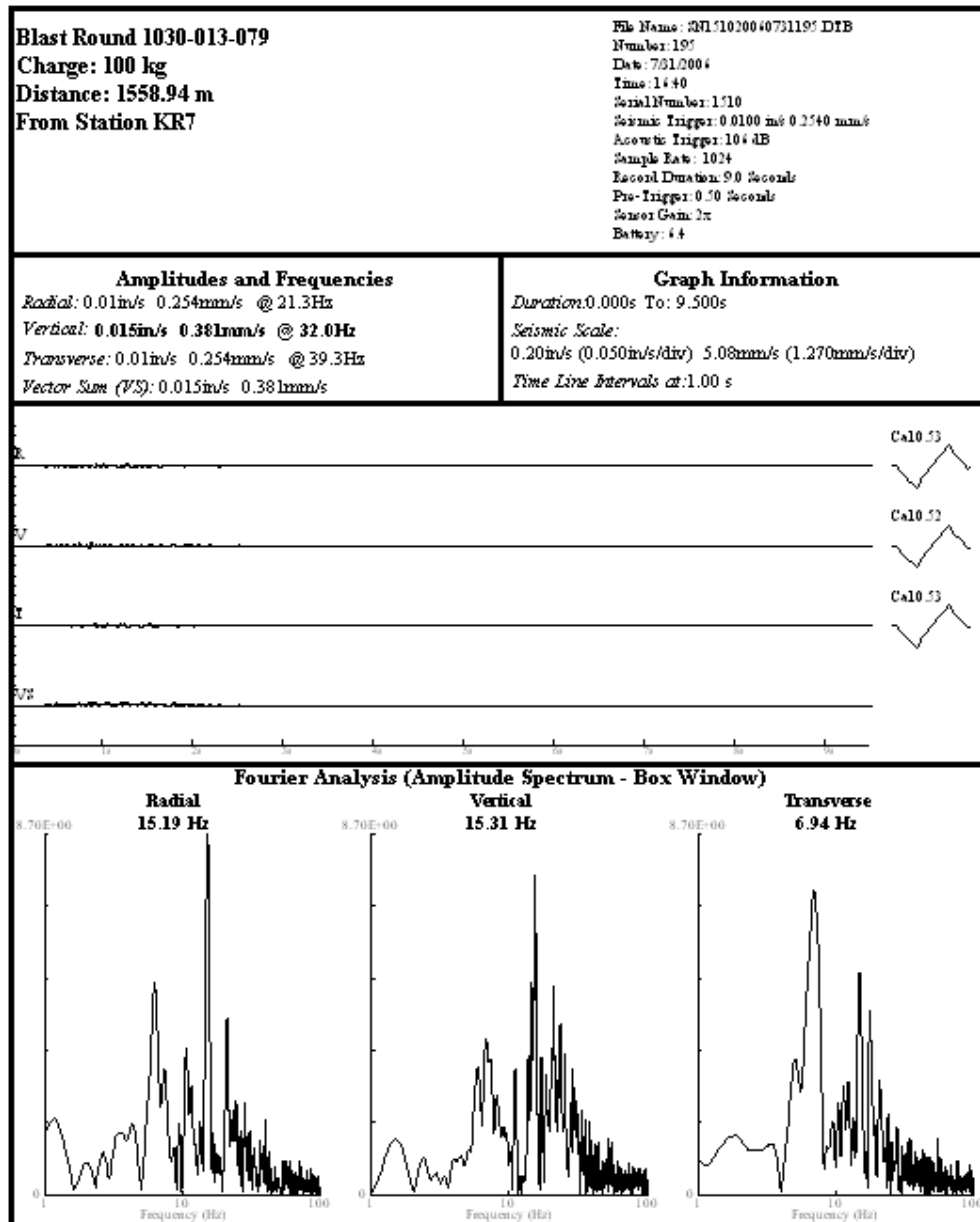

Figure C.11 11th vibration record taken along Karapınar District path.



## Event Report

Date/Time	Tran at 17:39:09 August 1, 2006	Serial Number	BE10316 V 8.01-8.0 MiniMate Plus
Trigger Source	Geo: 0.510 mm/s	Battery Level	6.1 Volts
	Mic: 106 dB(L)	Calibration	June 29, 2005 by Instantel, Inc
Range	Geo :31.7 mm/s	File Name	L316B9HN.P90
Record Time	3.0 sec (Auto=3Sec) at 2048 sps	Scaled Distance	30.0 (300.0 m, 100.0 kg)
Job Number:	1		

Notes  
Location:  
Client:  
User Name:  
General:

Extended Notes

Post Event Notes

Microphone Linear Weighting  
PSPL 91.5 dB(L) at 2.924 sec  
ZC Freq 7.1 Hz  
Channel Test Passed (Freq = 20.1 Hz Amp = 466 mv)

	Tran	Vert	Long	
PPV	0.556	0.286	0.460	mm/s
ZC Freq	8.7	16.8	11.5	Hz
Time (Rel. to Trig)	0.001	-0.189	-0.061	sec
Peak Acceleration	0.0166	0.0133	0.0133	g
Peak Displacement	0.00934	0.00418	0.00612	mm
Sensorcheck	Passed	Passed	Passed	
Frequency	7.6	7.5	7.3	Hz
Overswing Ratio	3.6	3.7	3.9	

USBM R18507 And OSMRE

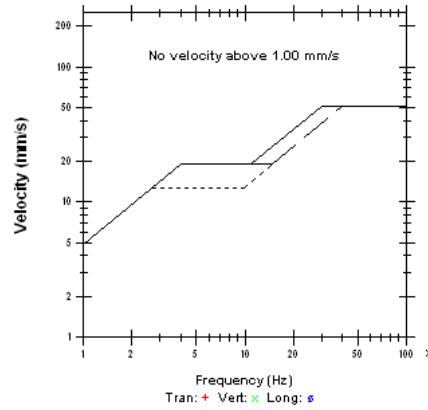

Peak Vector Sum 0.614 mm/s at -0.068 sec

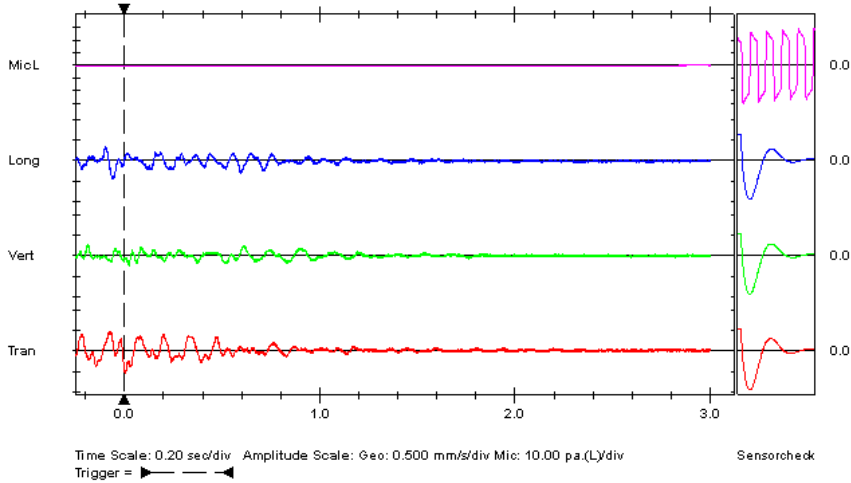

Printed: August 20, 2007 (V 8.01-8.01)

Format Copyrighted 1996-2004 Instantel Inc.

Figure C.12 12th vibration record taken along Karapınar District path.

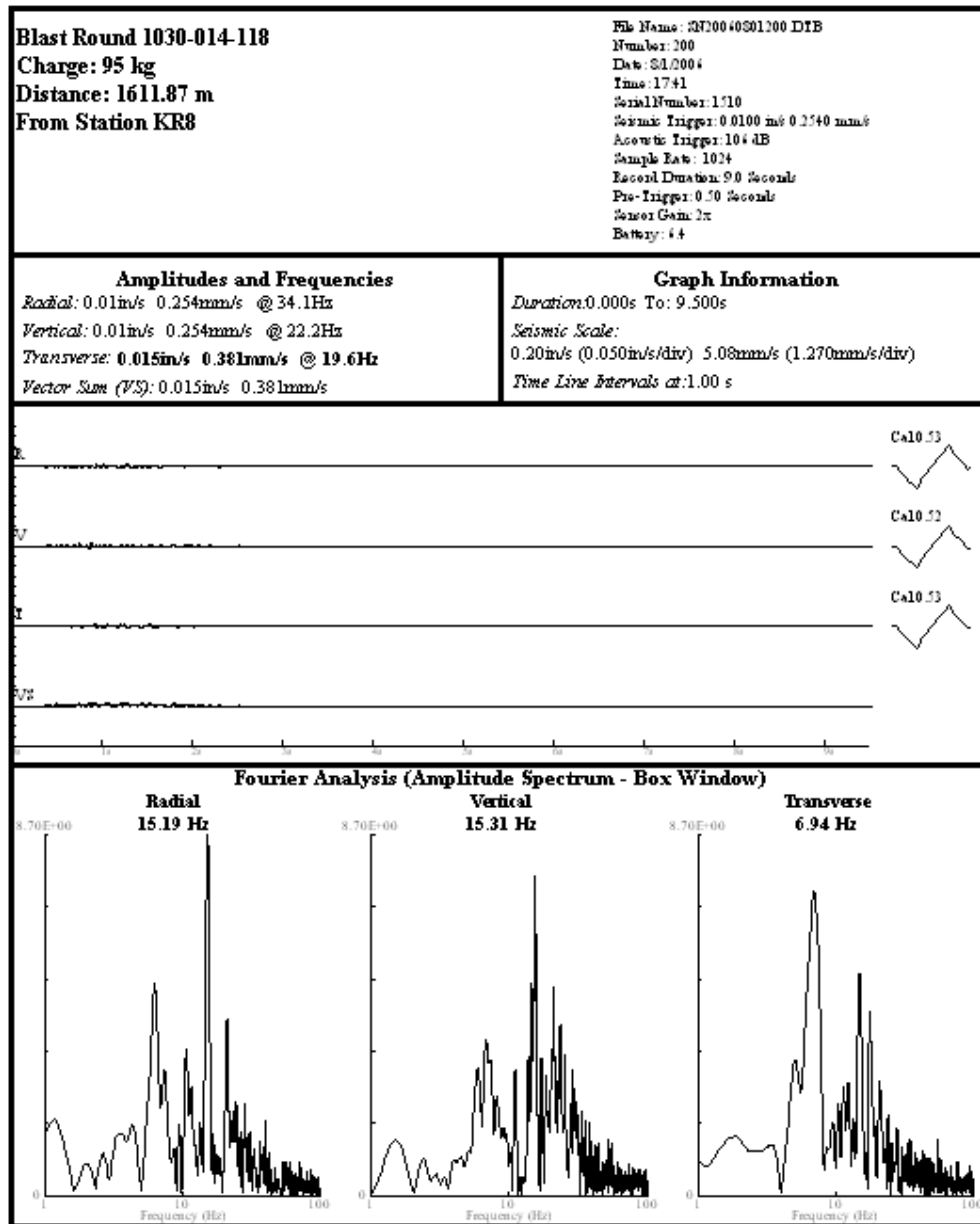

Figure C.13 13th vibration record taken along Karapınar District path.



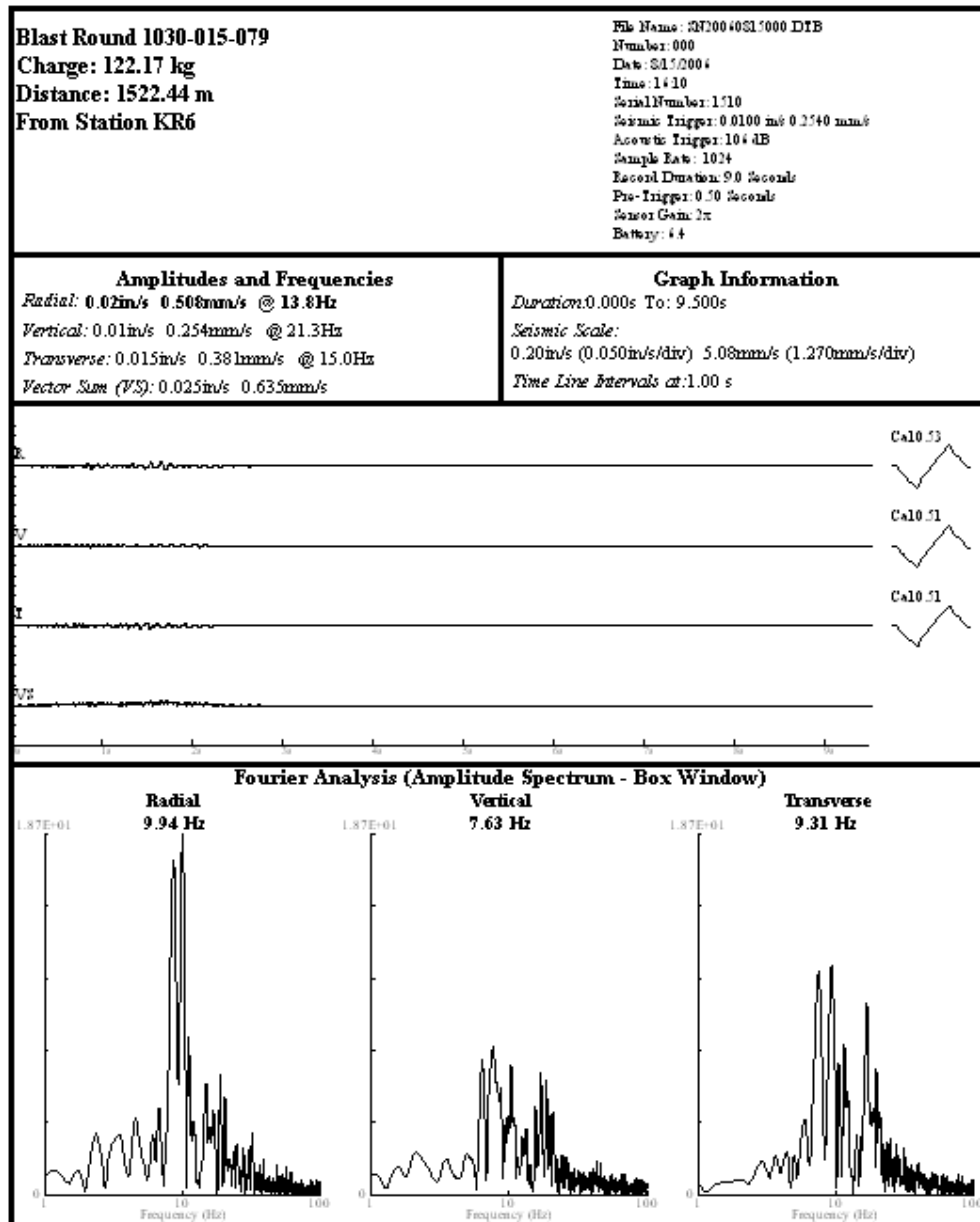

Figure C.14 14th vibration record taken along Karapınar District path.



## Event Report

Date/Time	Vert at 16:42:44 August 17, 2006	Serial Number	BE10317 V 8.01-8.0 MiniMate Plus
Trigger Source	Geo: 0.508 mm/s	Battery Level	6.4 Volts
	Mic: 110 dB(L)	Calibration	June 29, 2005 by Instantel, Inc
Range	Geo :31.7 mm/s	File Name	L317BAB7.R80
Record Time	4.0 sec (Auto=3Sec) at 2048 sps	Scaled Distance	99.0 (700.0 m, 50.0 kg)
Job Number:	1		

**Notes**

Location:  
Client:  
User Name:  
General:

**Extended Notes**

**Post Event Notes**

Microphone Linear Weighting  
 PSPL 103.5 dB(L) at 1.315 sec  
 ZC Freq 6.6 Hz  
 Channel Test Passed (Freq = 20.1 Hz Amp = 476 mv)

	Tran	Vert	Long	
PPV	0.841	1.00	1.02	mm/s
ZC Freq	15.8	12.6	26	Hz
Time (Rel. to Trig)	0.201	0.708	0.455	sec
Peak Acceleration	0.0199	0.0166	0.0199	g
Peak Displacement	0.00764	0.0118	0.00798	mm
Sensorcheck	Passed	Passed	Passed	
Frequency	7.5	7.6	7.4	Hz
Overswing Ratio	3.6	3.7	3.7	

**USBM RI8507 And OSMRE**

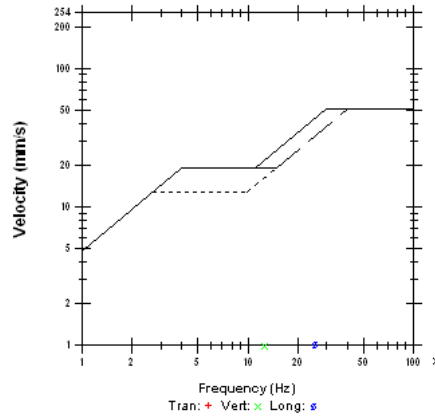

Peak Vector Sum 1.15 mm/s at 0.455 sec

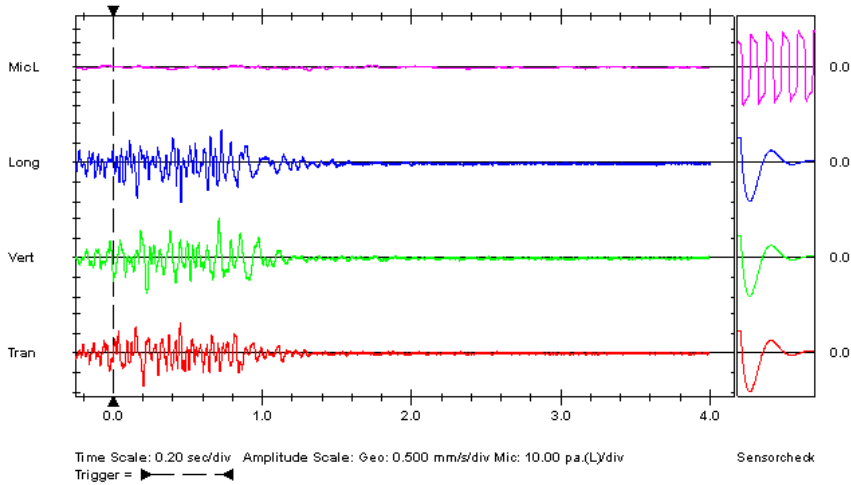

Printed: August 20, 2007 (V 8.01-8.01)

Format Copyrighted 1996-2004 Instantel Inc.

**Figure C.15** 15th vibration record taken along Karapınar District path.



### Event Report

Date/Time Long at 18:05:21 August 18, 2006  
 Trigger Source Geo: 0.510 mm/s  
 Range Geo :31.7 mm/s  
 Record Time 6.25 sec (Auto=3Sec) at 2048 sps  
 Job Number: 1

Serial Number BE10316 V 8.01-8.0 MiniMate Plus  
 Battery Level 6.2 Volts  
 Calibration June 29, 2005 by Instantel, Inc  
 File Name L316BAD6.SXD  
 Scaled Distance 30.0 (300.0 m, 100.0 kg)

Notes  
 Location:  
 Client:  
 User Name:  
 General:

Extended Notes

Post Event Notes

Microphone Linear Weighting  
 PSPL 114.2 dB(L) at 2.219 sec  
 ZC Freq 1.9 Hz  
 Channel Test Passed (Freq = 20.1 Hz Amp = 487 mv)

	Tran	Vert	Long	
PPV	0.429	0.571	0.778	mm/s
ZC Freq	11.5	14.2	11.3	Hz
Time (Rel. to Trig)	0.400	0.220	0.487	sec
Peak Acceleration	0.0133	0.0166	0.0166	g
Peak Displacement	0.00639	0.00645	0.00978	mm
Sensorcheck	Passed	Passed	Passed	
Frequency	7.5	7.3	7.5	Hz
Overswing Ratio	3.5	3.7	3.6	

USBM R18507 And OSMRE

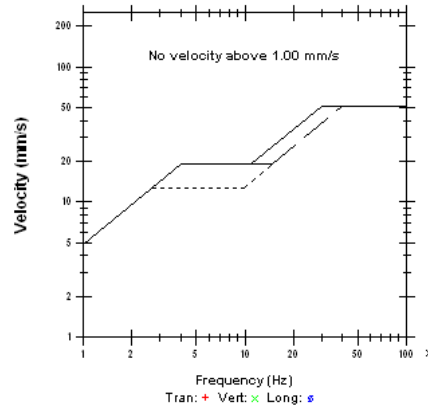

Peak Vector Sum 0.831 mm/s at 0.490 sec

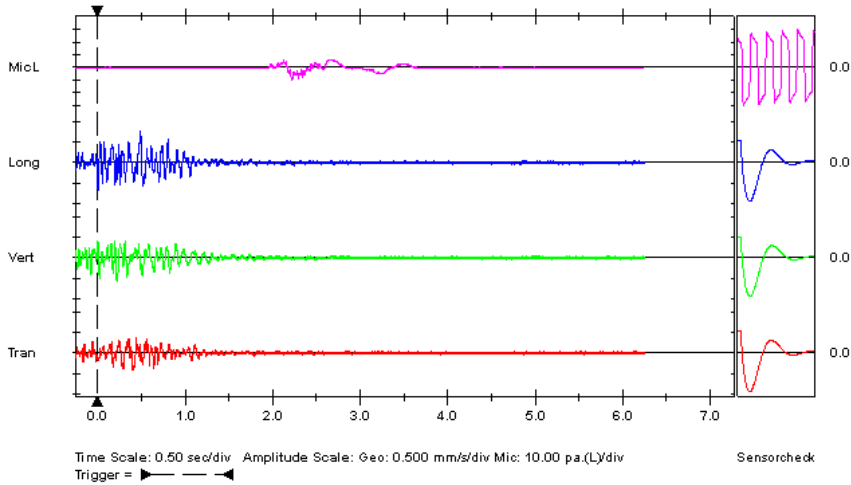

Printed: August 20, 2007 (V 8.01-8.01)

Format Copyrighted 1996-2004 Instantel Inc.

Figure C.16 16th vibration record taken along Karapınar District path.

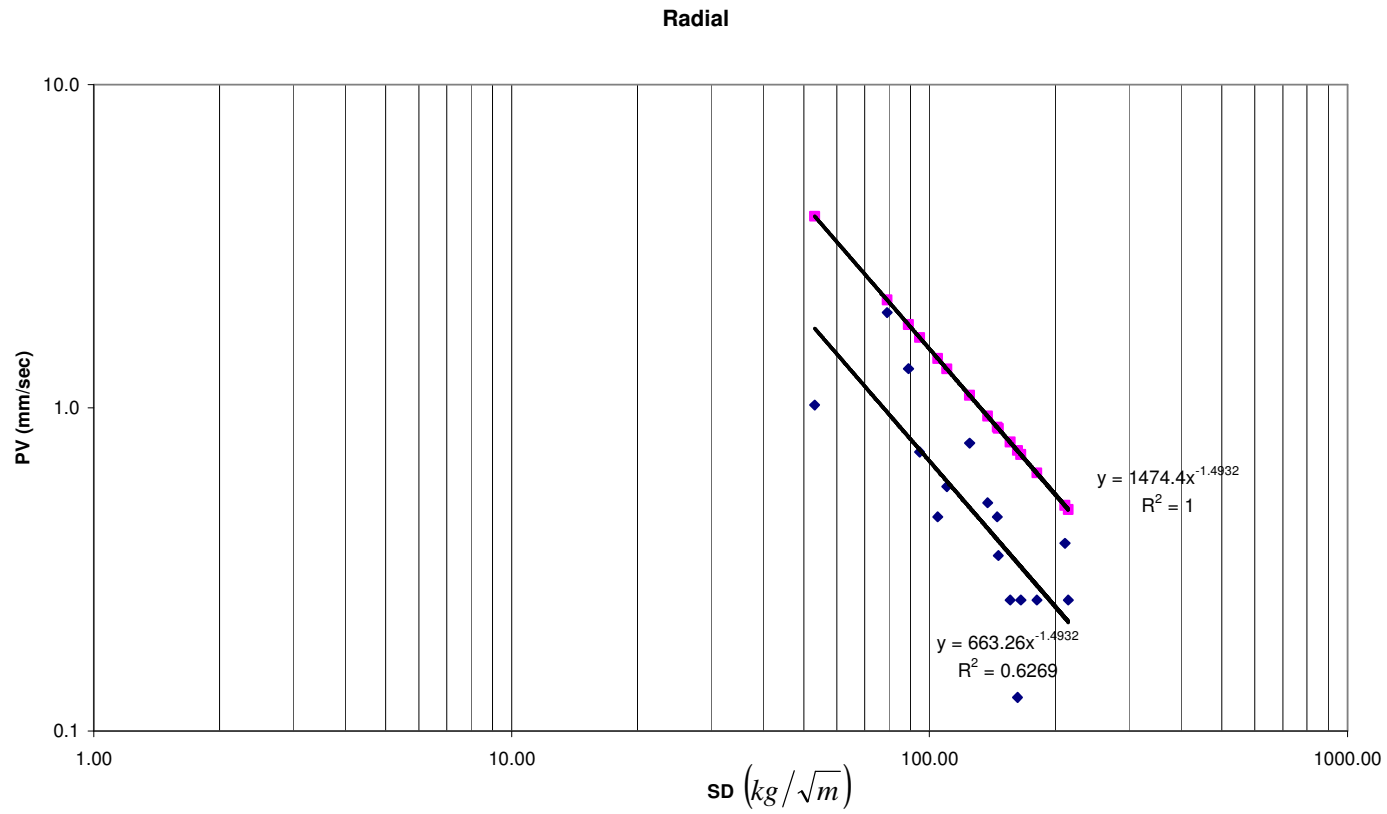

**Figure D.1** Scaled distance (SD) – particle velocity (PV) relation measured in longitudinal (R) component along Karapınar Village path

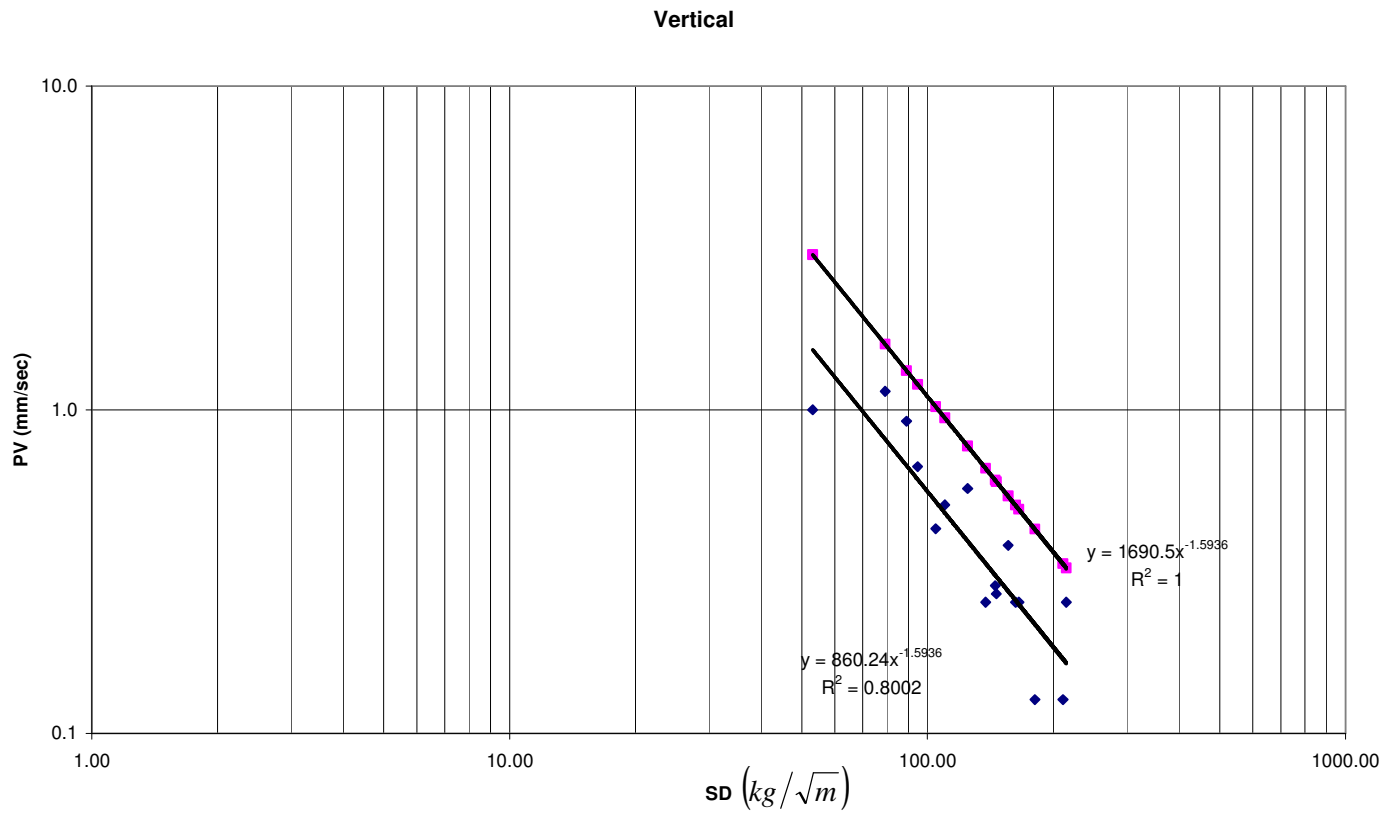

**Figure D.2** Scaled distance (SD) – particle velocity (PV) relation measured in vertical (V) component along Karapınar Village path

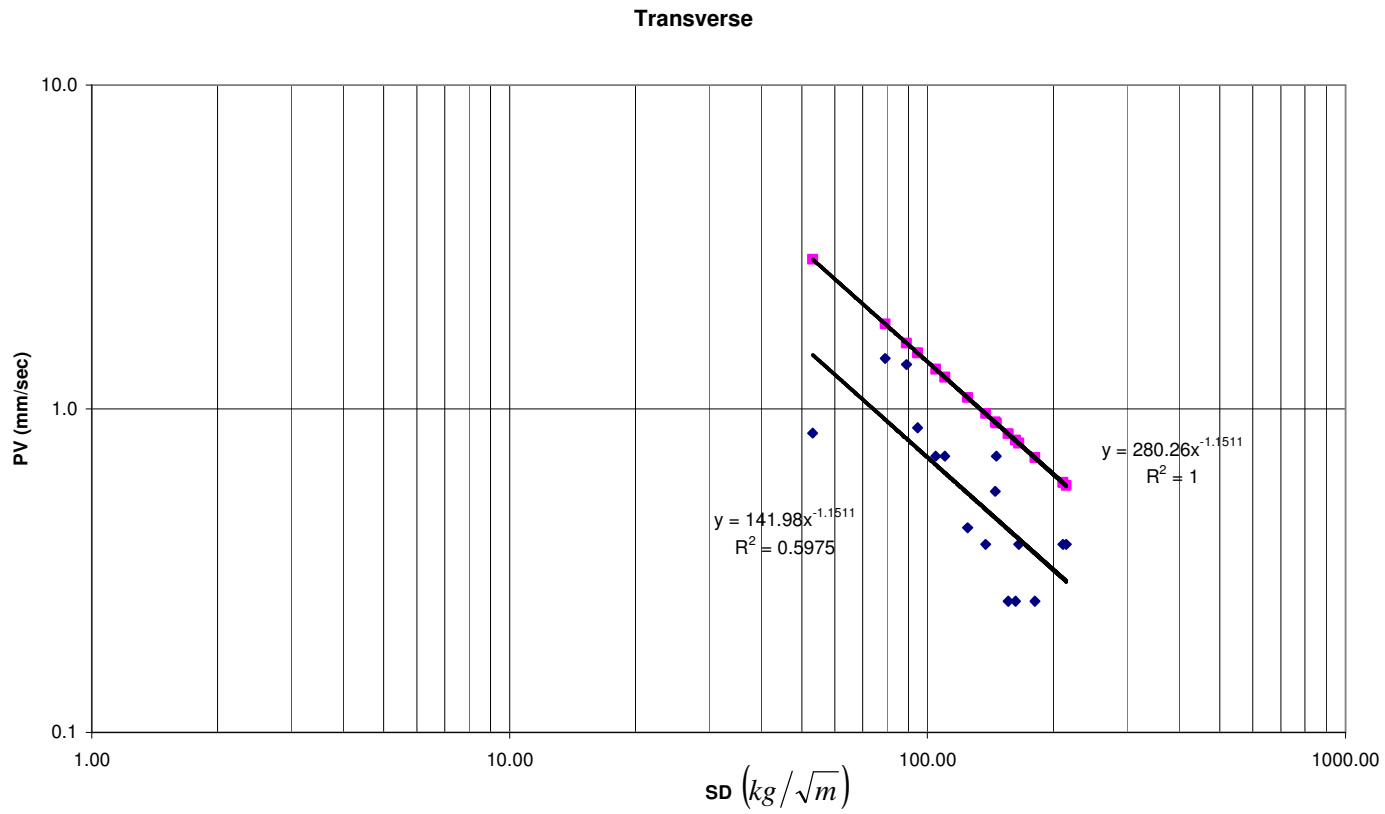

**Figure D.3** Scaled distance (SD) – particle velocity (PV) relation measured in transverse (T) component along Karapınar Village path

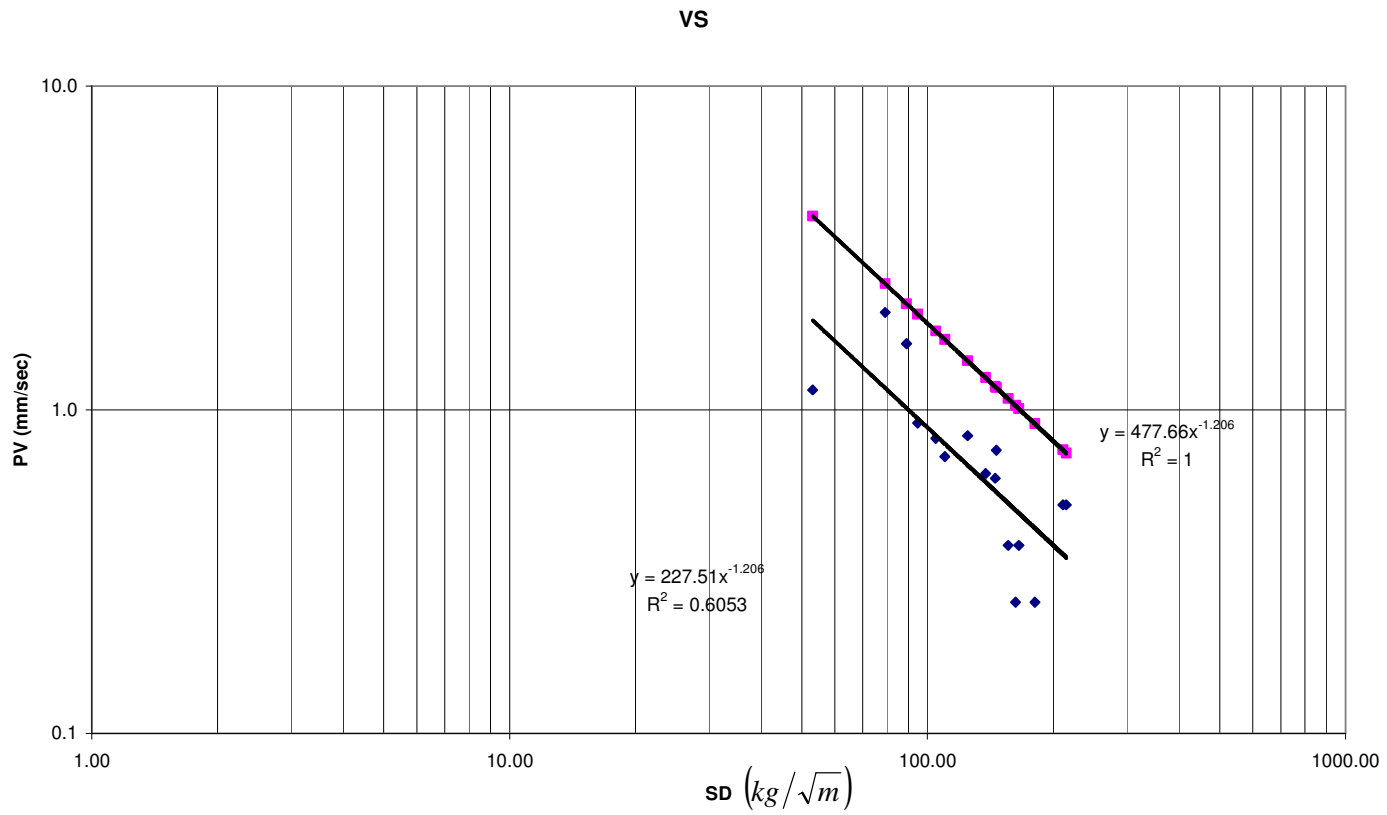

**Figure D.4** Scaled distance (SD) – particle velocity (PV) relation measured as vector sum (VS) along Karapınar Village path

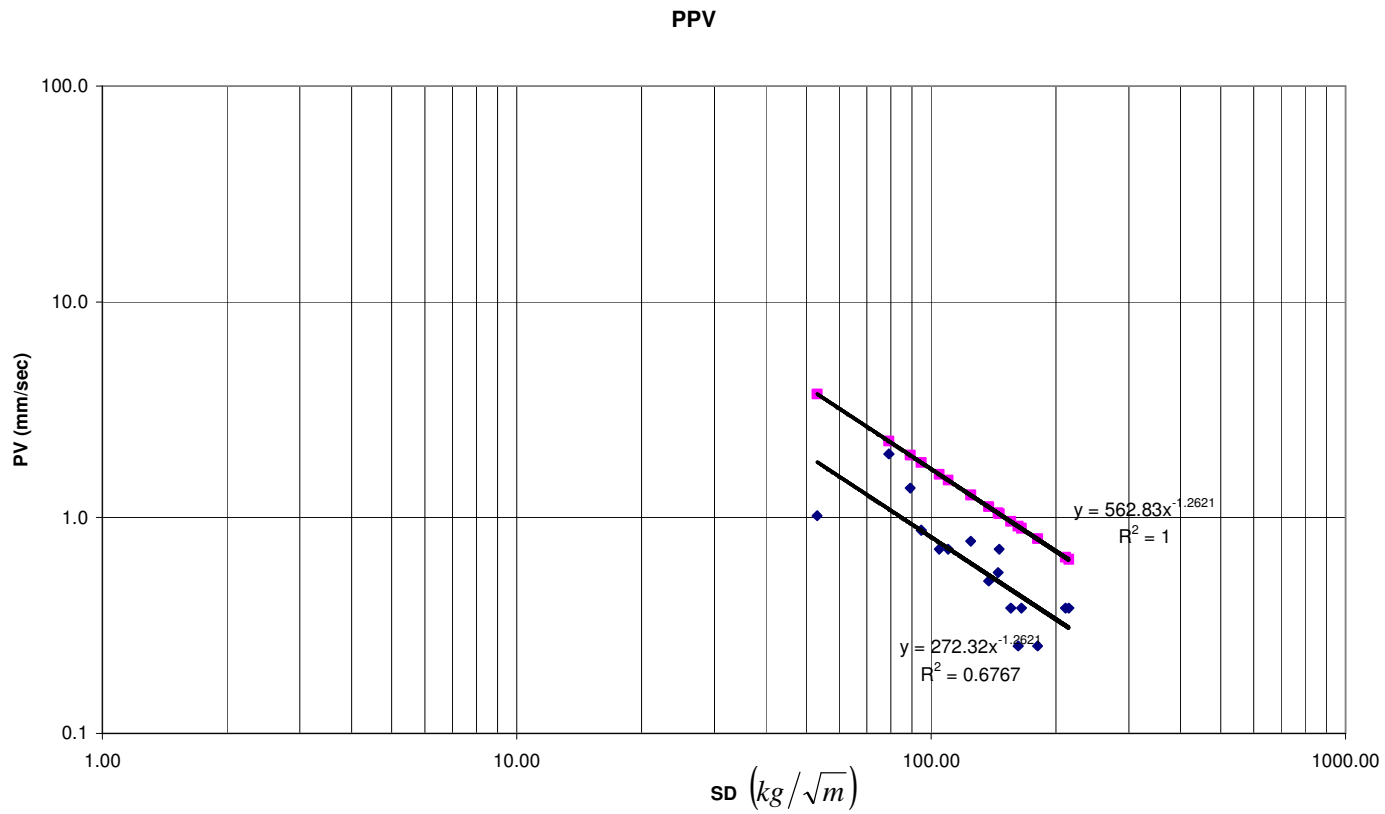

**Figure D.5** Scaled distance (SD) – peak particle velocity (PPV) relation measured along Karapınar Village path



# APPENDIX E



## Event Report

Date/Time Vert at 16:46:57 August 4, 2006  
 Trigger Source Geo: 0.508 mm/s  
 Range Geo :31.7 mm/s  
 Record Time 4.0 sec (Auto=3Sec) at 2048 sps  
 Job Number: 1

Serial Number BE10317 V 8.01-8.0 MiniMate Plus  
 Battery Level 6.3 Volts  
 Calibration June 29, 2005 by Instanter, Inc  
 File Name L317B0N5\_A90  
 Scaled Distance 99.0 (700.0 m, 50.0 kg)

Notes  
 Location:  
 Client:  
 User Name:  
 General:

Extended Notes

Post Event Notes

Microphone Linear Weighting  
 PSPL 104.9 dB(L) at 3.064 sec  
 ZC Freq 7.5 Hz  
 Channel Test Passed (Freq = 20.1 Hz Amp = 468 mv)

	Tran	Vert	Long	
PPV	1.30	1.25	1.08	mm/s
ZC Freq	28	27	24	Hz
Time (Rel. to Trig)	0.354	0.234	0.198	sec
Peak Acceleration	0.0298	0.0265	0.0265	g
Peak Displacement	0.0131	0.0133	0.00969	mm
Sensorcheck	Passed	Passed	Passed	
Frequency	7.5	7.3	7.7	Hz
Overswing Ratio	3.4	3.6	3.5	

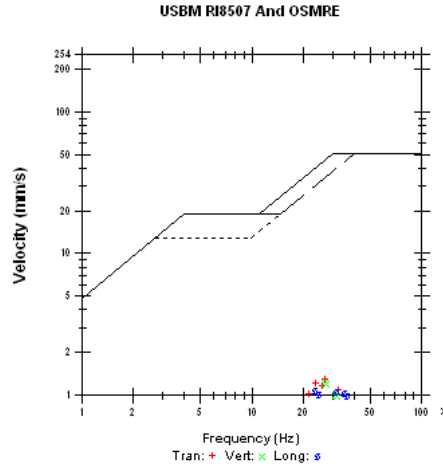

Peak Vector Sum 1.80 mm/s at 0.282 sec

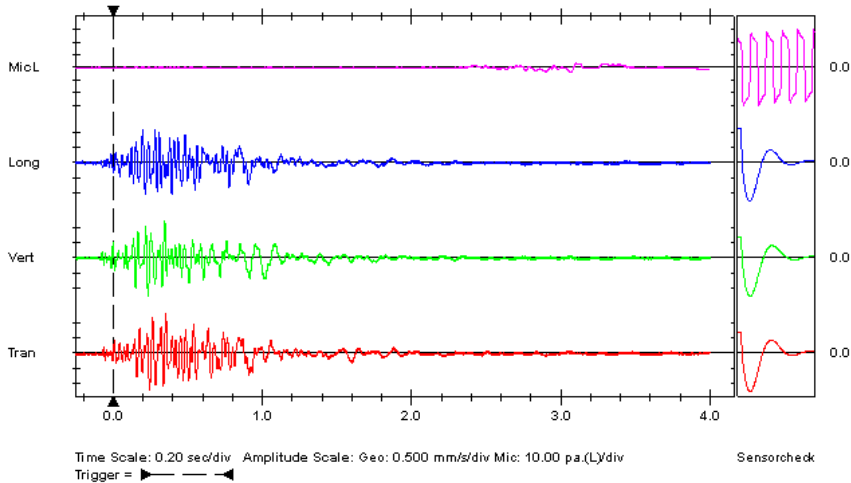

Printed: August 20, 2007 (V 8.01-8.01)

Format Copyrighted 1996-2004 Instanter, Inc.

Figure E.1 1st vibration record taken along Katrancilar District path.

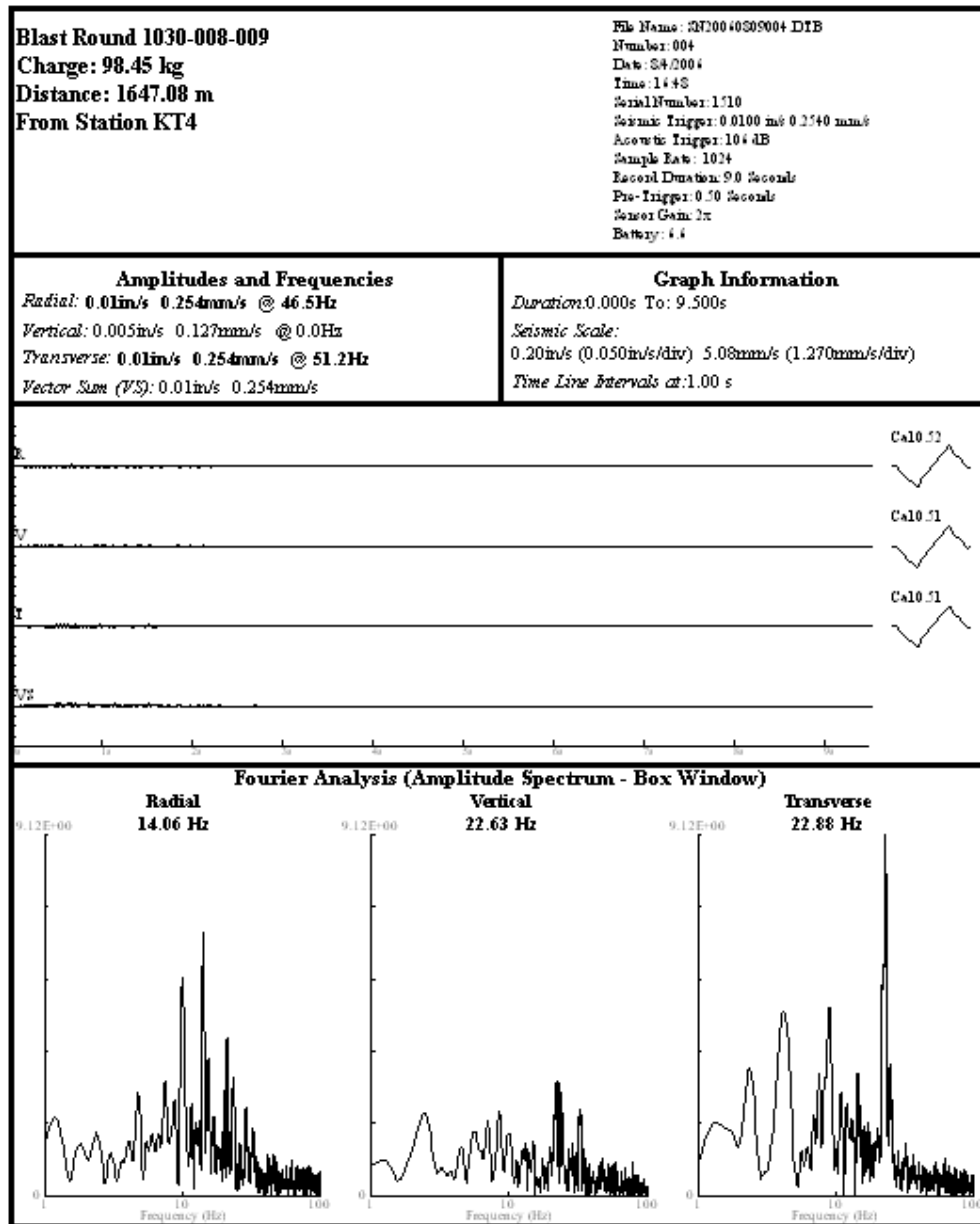

Figure E.2 2nd vibration record taken along Katrancilar District path.



### Event Report

Date/Time	Vert at 16:15:03 August 8, 2006	Serial Number	BE10317 V 8.01-8.0 MiniMate Plus
Trigger Source	Geo: 0.508 mm/s	Battery Level	6.3 Volts
	Mic: 110 dB(L)	Calibration	June 29, 2005 by Instantel, Inc
Range	Geo :31.7 mm/s	File Name	L317B9U1.H30
Record Time	4.0 sec (Auto=3Sec) at 2048 sps	Scaled Distance	99.0 (700.0 m, 50.0 kg)
Job Number:	1		

**Notes**

Location:  
Client:  
User Name:  
General:

**Extended Notes**

**Post Event Notes**

Microphone Linear Weighting  
 PSPL 106.0 dB(L) at 2.122 sec  
 ZC Freq 10.8 Hz  
 Channel Test Passed (Freq = 20.1 Hz Amp = 511 mv)

	Tran	Vert	Long	
PPV	1.11	0.968	0.857	mm/s
ZC Freq	19.7	19.3	16.0	Hz
Time (Rel. to Trig)	0.861	0.576	0.697	sec
Peak Acceleration	0.0232	0.0232	0.0199	g
Peak Displacement	0.00855	0.0130	0.00686	mm
Sensorcheck	Passed	Passed	Passed	
Frequency	7.3	7.2	7.5	Hz
Overswing Ratio	3.5	3.6	3.6	

**USBM RI8507 And OSMRE**

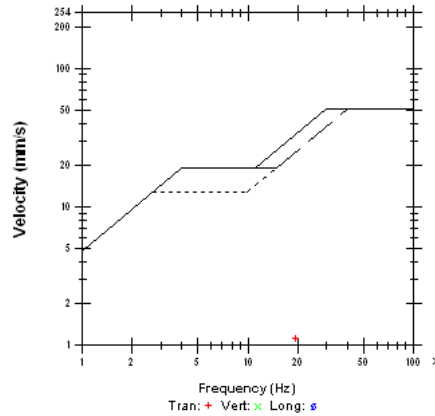

Peak Vector Sum 1.19 mm/s at 0.640 sec

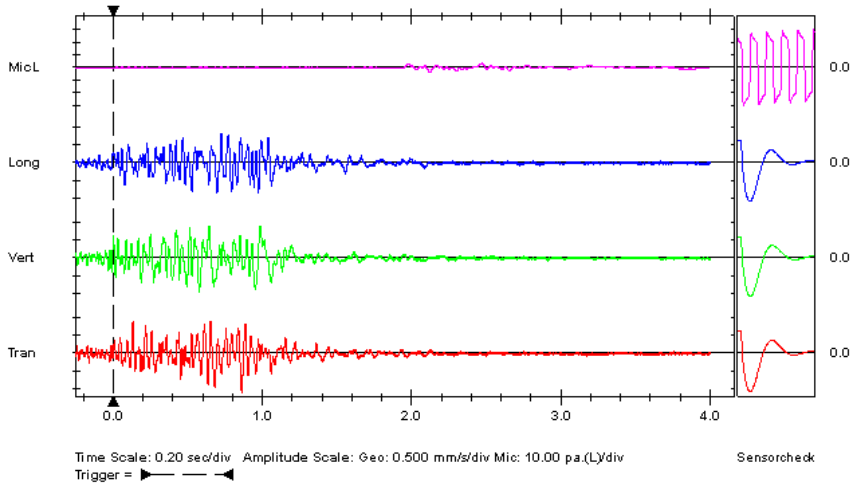

Printed: August 20, 2007 (V 8.01 - 8.01) Format Copyrighted 1996-2004 Instantel Inc.

**Figure E.3** 3rd vibration record taken along Katrancilar District path.



## Event Report

Date/Time Tran at 16:14:14 August 8, 2006  
 Trigger Source Geo: 0.510 mm/s  
 Range Geo :31.7 mm/s  
 Record Time 3.0 sec (Auto=3Sec) at 2048 sps  
 Job Number: 1

Serial Number BE10316 V 8.01-8.0 MiniMate Plus  
 Battery Level 5.9 Volts  
 Calibration June 29, 2005 by Instantel, Inc  
 File Name L316B9UI.FQ0  
 Scaled Distance 30.0 (300.0 m, 100.0 kg)

Notes  
 Location:  
 Client:  
 User Name:  
 General:

Extended Notes

Post Event Notes

Microphone Linear Weighting  
 PSPL 104.9 dB(L) at 1.699 sec  
 ZC Freq 11.0 Hz  
 Channel Test Passed (Freq = 20.1 Hz Amp = 456 mv)

	Tran	Vert	Long	
PPV	0.635	0.349	0.333	mm/s
ZC Freq	14.4	19.7	9.9	Hz
Time (Rel. to Trig)	0.007	-0.093	0.229	sec
Peak Acceleration	0.0133	0.0133	0.0133	g
Peak Displacement	0.00696	0.00492	0.00482	mm
Sensorcheck	Passed	Passed	Passed	
Frequency	7.6	7.5	7.4	Hz
Overswing Ratio	3.6	3.8	3.9	

USBM R18507 And OSMRE

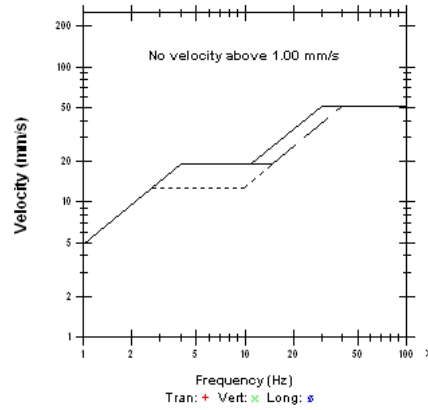

Peak Vector Sum 0.714 mm/s at 0.007 sec

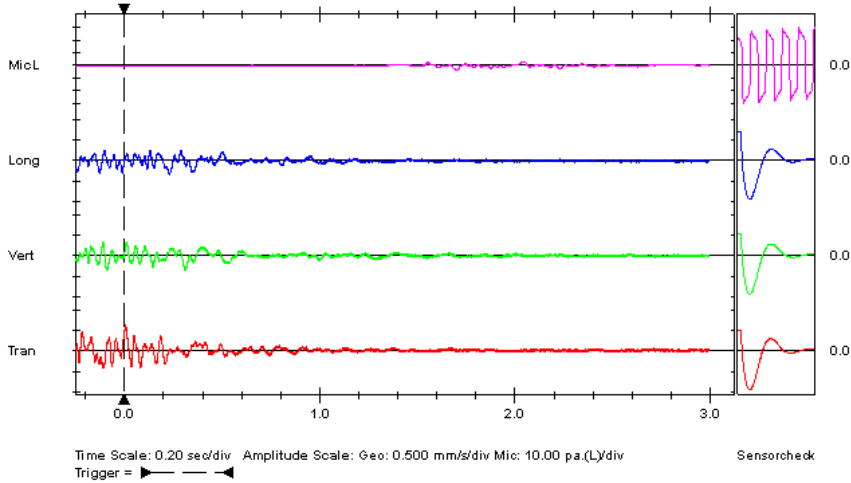

Printed: August 20, 2007 (V 8.01-8.01)

Format Copyrighted 1996-2004 Instantel Inc.

Figure E.4 4th vibration record taken along Katrancilar District path.

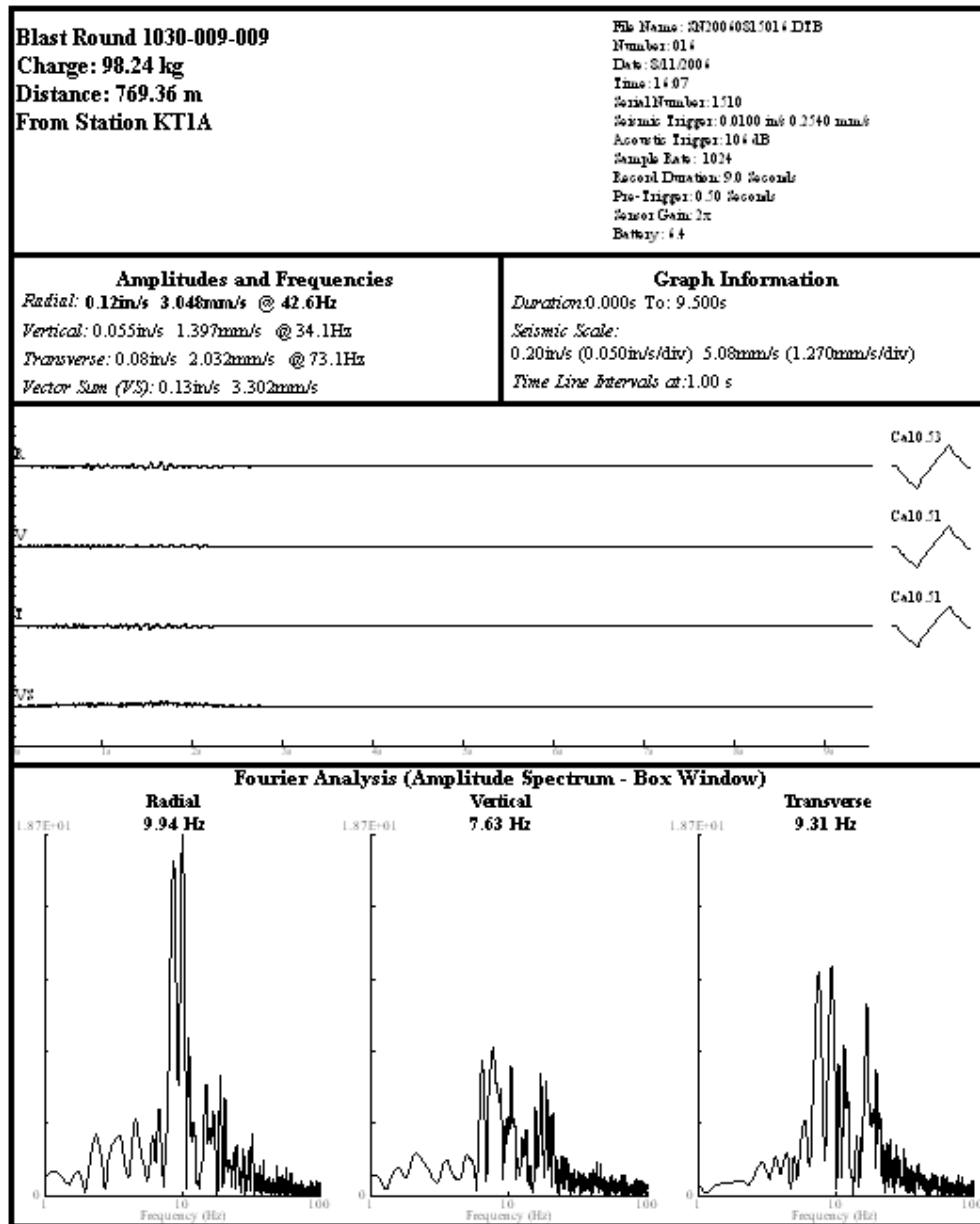

Figure E.5 5th vibration record taken along Katrancilar District path.



## Event Report

Date/Time Long at 16:04:54 August 11, 2006  
 Trigger Source Geo: 0.508 mm/s  
 Range Geo :31.7 mm/s  
 Record Time 3.75 sec (Auto=3Sec) at 2048 sps  
 Job Number: 1

Serial Number BE10317 V 8.01-8.0 MiniMate Plus  
 Battery Level 6.3 Volts  
 Calibration June 29, 2005 by Instantel, Inc  
 File Name L317BA02.060  
 Scaled Distance 99.0 (700.0 m, 50.0 kg)

Notes  
 Location:  
 Client:  
 User Name:  
 General:

Extended Notes

Post Event Notes

Microphone Linear Weighting  
 PSPL 106.5 dB(L) at 2.153 sec  
 ZC Freq 6.8 Hz  
 Channel Test Passed (Freq = 20.5 Hz Amp = 469 mv)

	Tran	Vert	Long	
PPV	0.921	0.794	1.08	mm/s
ZC Freq	37	23	37	Hz
Time (Rel. to Trig)	0.262	0.252	0.524	sec
Peak Acceleration	0.0298	0.0232	0.0298	g
Peak Displacement	0.00549	0.00565	0.00536	mm
Sensorcheck	Passed	Passed	Passed	
Frequency	7.4	7.3	7.6	Hz
Overswing Ratio	3.5	3.6	3.5	

USBM RI8507 And OSMRE

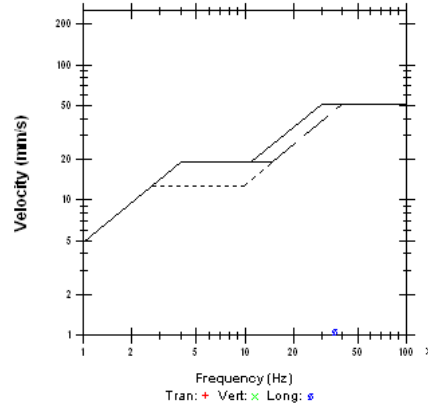

Peak Vector Sum 1.18 mm/s at 0.674 sec

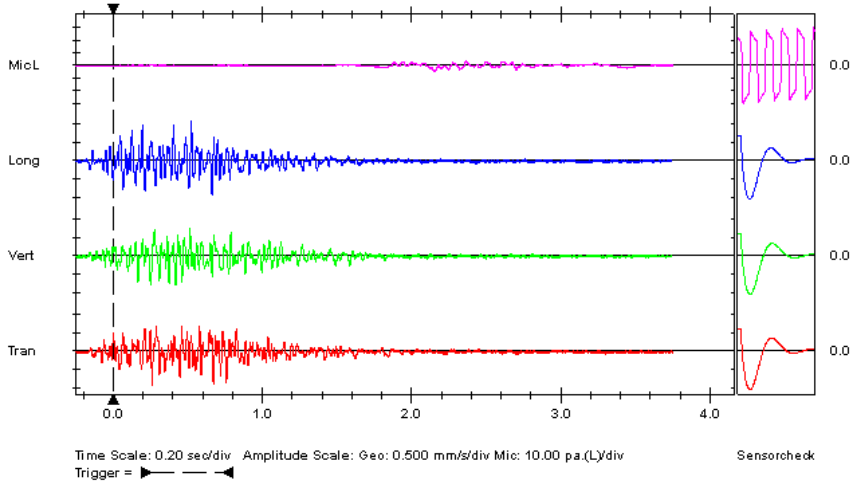

Printed: August 20, 2007 (V 8.01-8.01)

Format Copyrighted 1996-2004 Instantel Inc.

Figure E.6 6th vibration record taken along Katrancilar District path.



## Event Report

Date/Time Long at 16:03:59 August 11, 2006  
 Trigger Source Geo: 0.510 mm/s  
 Range Geo :31.7 mm/s  
 Record Time 3.0 sec (Auto=3Sec) at 2048 sps  
 Job Number: 1

Serial Number BE10316 V 8.01-8.0 MiniMate Plus  
 Battery Level 5.9 Volts  
 Calibration June 29, 2005 by Instantel, Inc  
 File Name L316BA01.YNO  
 Scaled Distance 30.0 (300.0 m, 100.0 kg)

Notes  
 Location:  
 Client:  
 User Name:  
 General:

Extended Notes

Post Event Notes

Microphone Linear Weighting  
 PSPL 104.2 dB(L) at 2.564 sec  
 ZC Freq 6.1 Hz  
 Channel Test Passed (Freq = 20.1 Hz Amp = 499 mv)

	Tran	Vert	Long	
PPV	0.460	0.349	0.571	mm/s
ZC Freq	8.9	19.0	14.4	Hz
Time (Rel. to Trig)	0.120	0.018	0.003	sec
Peak Acceleration	0.0133	0.0133	0.0166	g
Peak Displacement	0.00553	0.00269	0.00458	mm
Sensorcheck	Passed	Passed	Passed	
Frequency	7.6	7.5	7.4	Hz
Overswing Ratio	3.6	3.7	3.7	

USBM R18507 And OSMRE

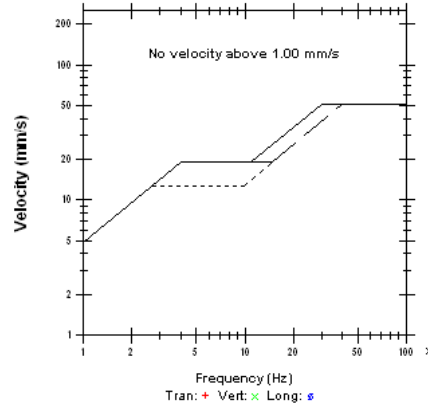

Peak Vector Sum 0.580 mm/s at 0.003 sec

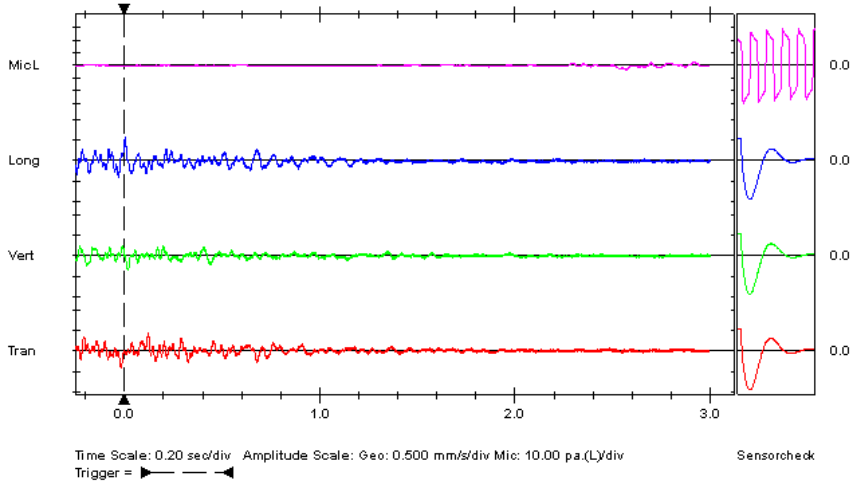

Printed: August 20, 2007 (V 8.01-8.01)

Format Copyrighted 1996-2004 Instantel Inc.

Figure E.7 7th vibration record taken along Katrancilar District path.



### Event Report

Date/Time Long at 16:06:29 August 15, 2006  
 Trigger Source Geo: 0.510 mm/s  
 Range Geo :31.7 mm/s  
 Record Time 3.75 sec (Auto=3Sec) at 2048 sps  
 Job Number: 1

Serial Number BE10316 V 8.01-8.0 MiniMate Plus  
 Battery Level 5.9 Volts (Battery Low)  
 Calibration June 29, 2005 by Instantel, Inc  
 File Name L316BA7 G.QTD  
 Scaled Distance 30.0 (300.0 m, 100.0 kg)

Notes  
 Location:  
 Client:  
 User Name:  
 General:

Extended Notes

Post Event Notes

Microphone Linear Weighting  
 PSPL 101.0 dB(L) at 2.867 sec  
 ZC Freq 6.7 Hz  
 Channel Test Passed (Freq = 20.1 Hz Amp = 439 mv)

	Tran	Vert	Long	
PPV	0.857	0.508	0.619	mm/s
ZC Freq	9.9	10.4	12.8	Hz
Time (Rel. to Trig)	0.264	0.297	0.004	sec
Peak Acceleration	0.0166	0.0133	0.0133	g
Peak Displacement	0.0150	0.00823	0.0131	mm
Sensorcheck	Passed	Passed	Passed	
Frequency	7.6	7.4	7.3	Hz
Overswing Ratio	3.6	3.7	3.8	

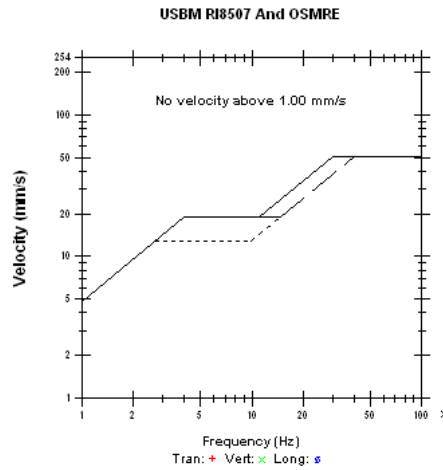

Peak Vector Sum 0.890 mm/s at 0.265 sec

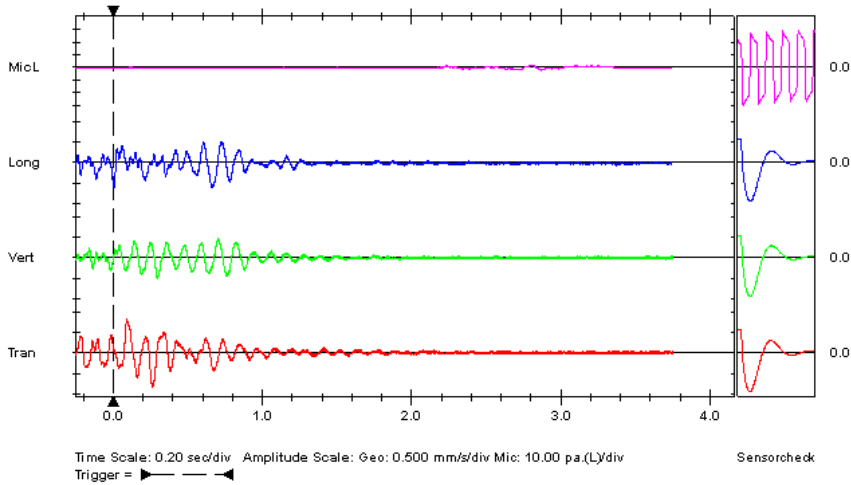

Printed: August 20, 2007 (V 8.01-8.01)

Format Copyrighted 1996-2004 Instantel Inc.

Figure E.8 8th vibration record taken along Katrancilar District path.





## Event Report

Date/Time Tran at 16:41:36 August 17, 2006  
 Trigger Source Geo: 0.510 mm/s  
 Range Geo :31.7 mm/s  
 Record Time 4.5 sec (Auto=3Sec) at 2048 sps  
 Job Number: 1

Serial Number BE10316 V 8.01-8.0 MiniMate Plus  
 Battery Level 6.2 Volts  
 Calibration June 29, 2005 by Instantel, Inc  
 File Name L316BAB7.PCO  
 Scaled Distance 30.0 (300.0 m, 100.0 kg)

Notes  
 Location:  
 Client:  
 User Name:  
 General:

Extended Notes

Post Event Notes

Microphone Linear Weighting  
 PSPL 106.0 dB(L) at 1.461 sec  
 ZC Freq 6.6 Hz  
 Channel Test Passed (Freq = 20.1 Hz Amp = 352 mv)

	Tran	Vert	Long	
PPV	0.968	0.667	0.746	mm/s
ZC Freq	41	19.7	39	Hz
Time (Rel. to Trig)	0.587	0.349	0.404	sec
Peak Acceleration	0.0298	0.0232	0.0265	g
Peak Displacement	0.00701	0.00547	0.00320	mm
Sensorcheck	Passed	Passed	Passed	
Frequency	7.5	7.3	7.6	Hz
Overswing Ratio	3.4	3.5	3.4	

USBM RI8507 And OSMRE

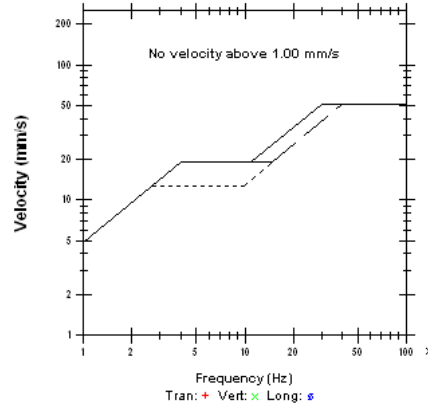

Peak Vector Sum 1.01 mm/s at 0.587 sec

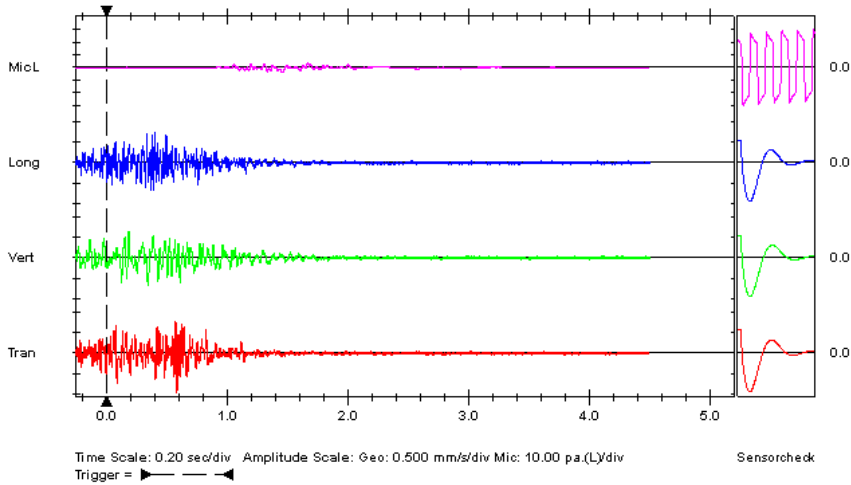

Printed: August 20, 2007 (V 8.01-8.01)

Format Copyrighted 1996-2004 Instantel Inc.

Figure E.9 9th vibration record taken along Katrancilar District path.

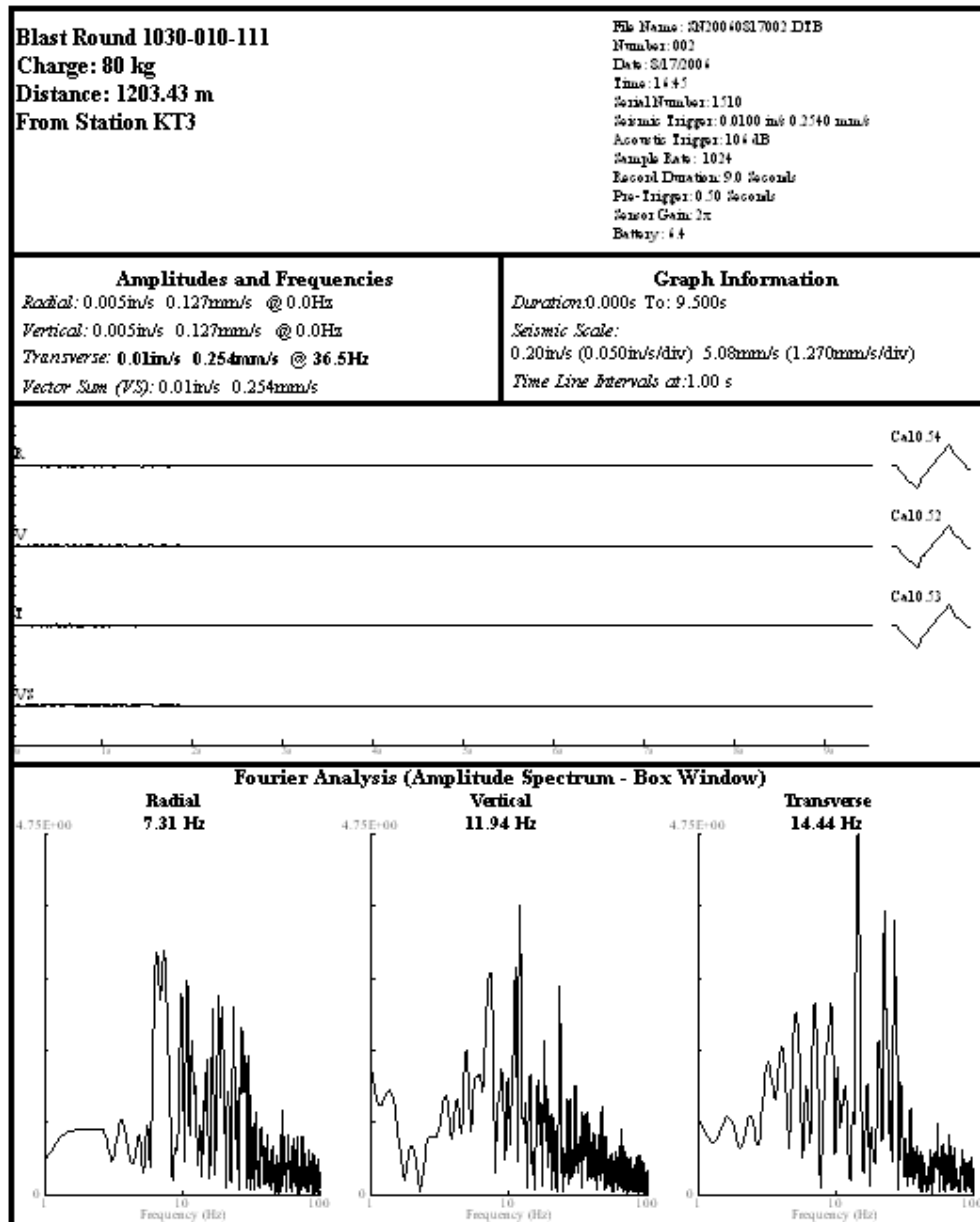

Figure E.10 10th vibration record taken along Katrancilar District path.



### Event Report

Date/Time Long at 18:06:31 August 18, 2006  
 Trigger Source Geo: 0.508 mm/s  
 Range Geo :31.7 mm/s  
 Record Time 4.25 sec (Auto=3Sec) at 2048 sps  
 Job Number: 1

Serial Number BE10317 V 8.01-8.0 MiniMate Plus  
 Battery Level 6.3 Volts  
 Calibration June 29, 2005 by Instantel, Inc  
 File Name L317BAD6.AVO  
 Scaled Distance 99.0 (700.0 m, 50.0 kg)

Notes  
 Location:  
 Client:  
 User Name:  
 General:

Extended Notes

Post Event Notes

Microphone Linear Weighting  
 PSPL 94.0 dB(L) at 0.760 sec  
 ZC Freq 33 Hz  
 Channel Test Check (Freq = 0.0 Hz Amp = 0 mv)

	Tran	Vert	Long	
PPV	1.46	1.71	2.38	mm/s
ZC Freq	15.8	13.3	16.3	Hz
Time (Rel. to Trig)	0.543	0.585	0.720	sec
Peak Acceleration	0.0365	0.0265	0.0464	g
Peak Displacement	0.0141	0.0153	0.0179	mm
Sensorcheck	Passed	Passed	Passed	
Frequency	7.5	7.5	7.5	Hz
Overswing Ratio	3.6	3.8	3.9	

USBM R18507 And OSMRE

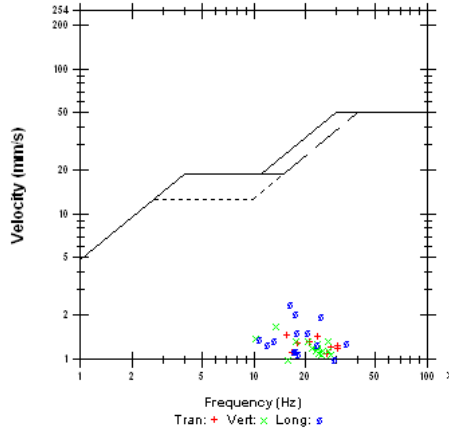

Peak Vector Sum 2.60 mm/s at 0.720 sec

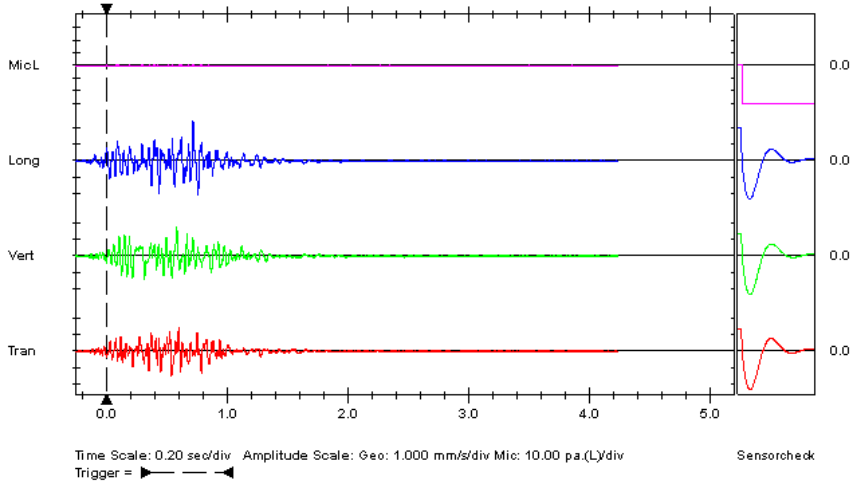

Printed: August 20, 2007 (V 8.01-8.01)

Format Copyrighted 1996-2004 Instantel Inc.

Figure E.11 11th vibration record taken along Katrancilar District path.

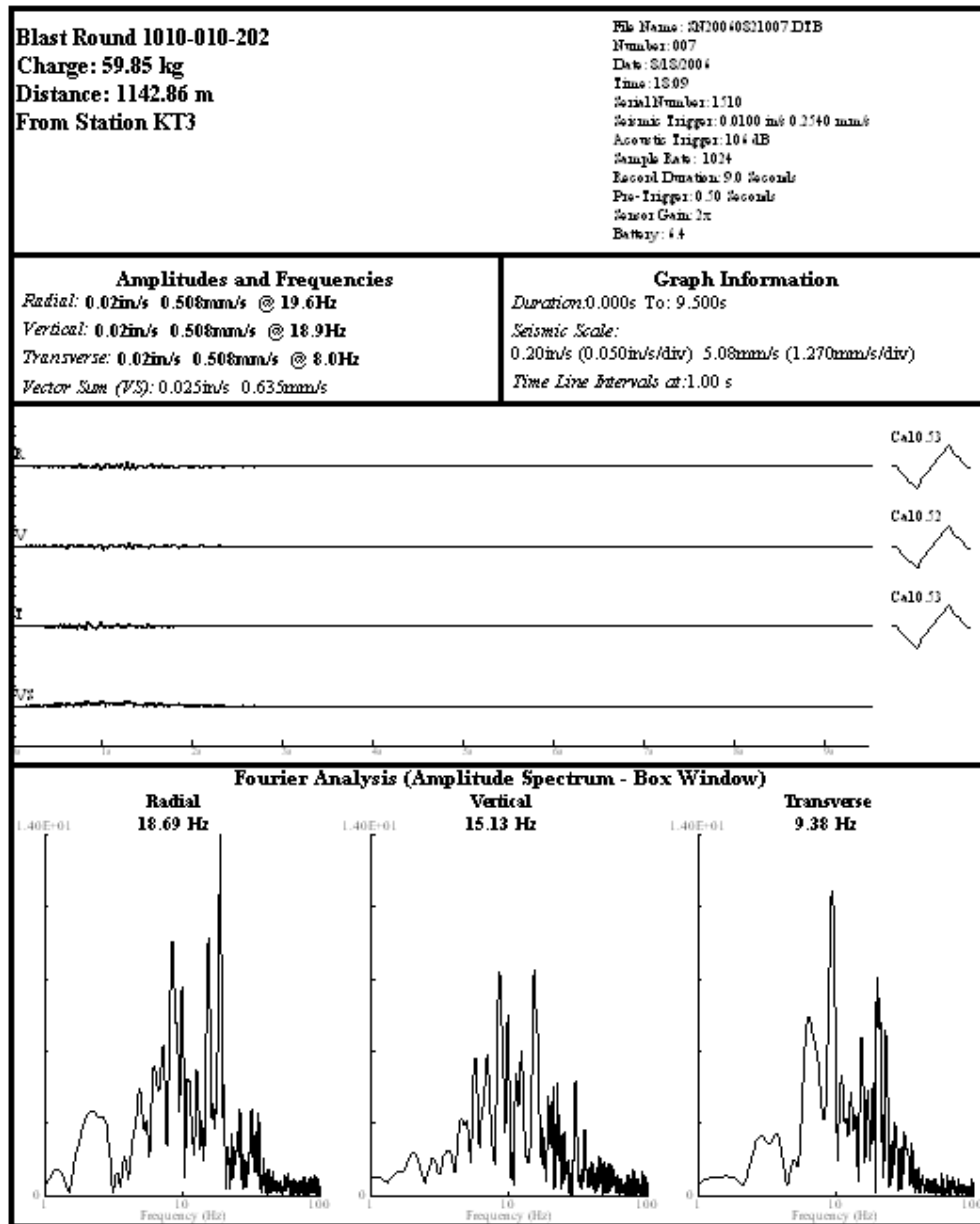

Figure E.12 12th vibration record taken along Katrancilar District path.



### Event Report

Date/Time Tran at 16:41:35 August 22, 2006  
 Trigger Source Geo: 0.508 mm/s  
 Range Geo :31.7 mm/s  
 Record Time 4.5 sec (Auto=3Sec) at 2048 sps  
 Job Number: 1

Serial Number BE10317 V 8.01-8.0 MiniMate Plus  
 Battery Level 6.3 Volts  
 Calibration June 29, 2005 by Instantel, Inc  
 File Name L317BAKH.1B0  
 Scaled Distance 99.0 (700.0 m, 50.0 kg)

Notes  
 Location:  
 Client:  
 User Name:  
 General:

Extended Notes

Post Event Notes

Microphone Linear Weighting  
 PSPL 101.9 dB(L) at 1.820 sec  
 ZC Freq 13.0 Hz  
 Channel Test Passed (Freq = 20.1 Hz Amp = 454 mv)

	Tran	Vert	Long	
PPV	1.35	0.778	1.38	mm/s
ZC Freq	41	33	38	Hz
Time (Rel. to Trig)	0.383	0.287	0.322	sec
Peak Acceleration	0.0398	0.0232	0.0464	g
Peak Displacement	0.00997	0.00710	0.00822	mm
Sensorcheck	Passed	Passed	Passed	
Frequency	7.5	7.5	7.4	Hz
Overswing Ratio	3.6	3.7	3.7	

USBM R18507 And OSMRE

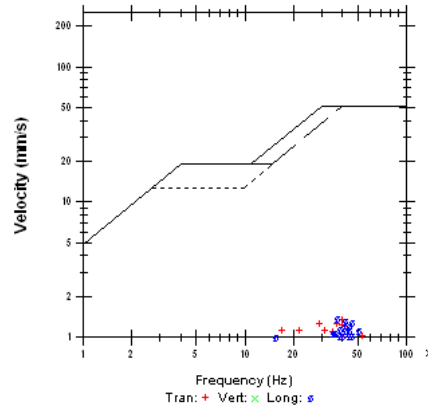

Peak Vector Sum 1.88 mm/s at 0.383 sec

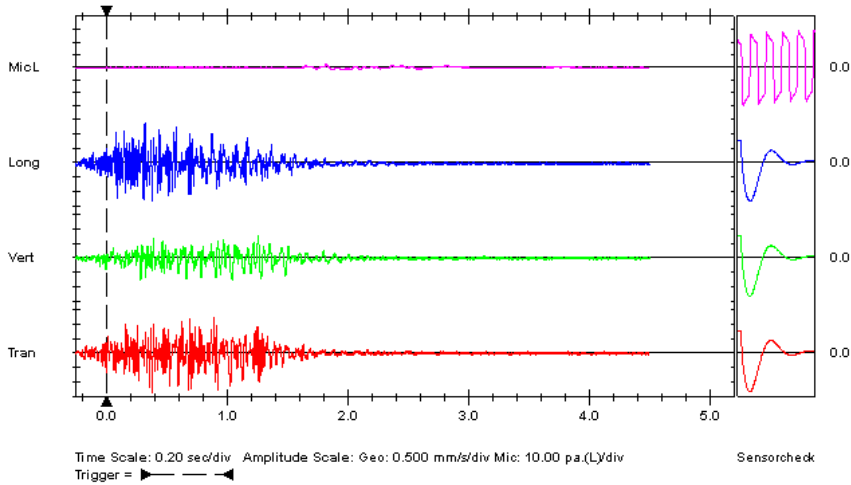

Printed: August 20, 2007 (V 8.01-8.01)

Format Copyrighted 1996-2004 Instantel Inc.

Figure E.13 13th vibration record taken along Katrancilar District path.



### Event Report

Date/Time Tran at 16:40:17 August 22, 2006  
 Trigger Source Geo: 0.510 mm/s  
 Range Geo :31.7 mm/s  
 Record Time 4.25 sec (Auto=3Sec) at 2048 sps  
 Job Number: 1

Serial Number BE10316 V 8.01-8.0 MiniMate Plus  
 Battery Level 6.1 Volts  
 Calibration June 29, 2005 by Instantel, Inc  
 File Name L316BAK9.Z50  
 Scaled Distance 30.0 (300.0 m, 100.0 kg)

Notes  
 Location:  
 Client:  
 User Name:  
 General:

Extended Notes

Post Event Notes

Microphone Linear Weighting  
 PSPL 104.9 dB(L) at 2.053 sec  
 ZC Freq 11.0 Hz  
 Channel Test Passed (Freq = 20.5 Hz Amp = 424 mv)

	Tran	Vert	Long	
PPV	0.968	0.794	0.883	mm/s
ZC Freq	17.1	27	17.1	Hz
Time (Rel. to Trig)	0.862	0.622	0.923	sec
Peak Acceleration	0.0232	0.0199	0.0199	g
Peak Displacement	0.00757	0.00861	0.00591	mm
Sensorcheck	Passed	Passed	Check	
Frequency	7.5	7.3	8.5	Hz
Overswing Ratio	3.5	3.6	3.9	

USBM R18507 And OSMRE

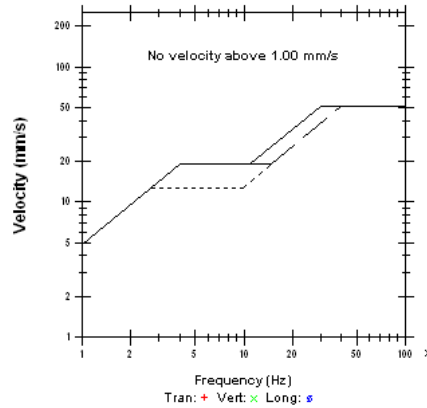

Peak Vector Sum 1.16 mm/s at 0.717 sec

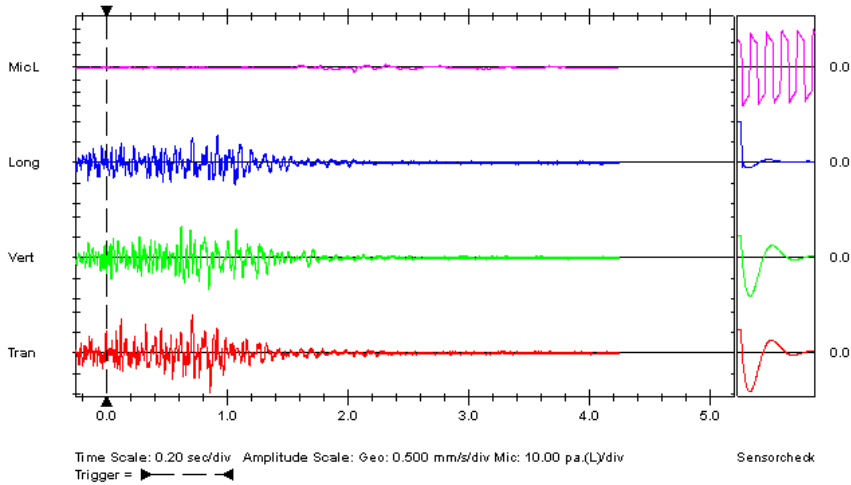

Printed: August 20, 2007 (V 8.01-8.01)

Format Copyrighted 1996-2004 Instantel Inc.

Figure E.14 14th vibration record taken along Katrancilar District path.

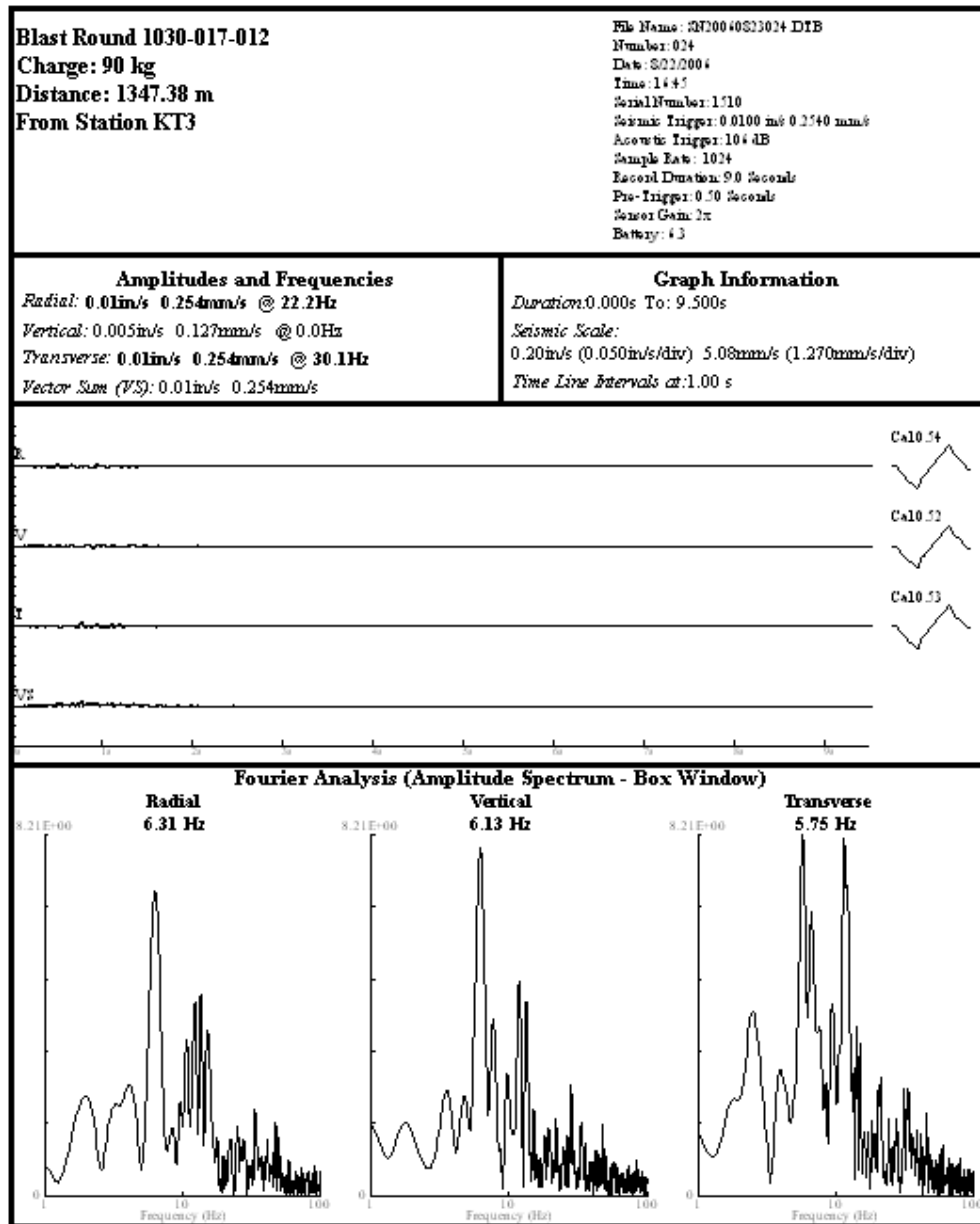

Figure E.15 15th vibration record taken along Katrancilar District path.



### Event Report

Date/Time Long at 14:13:19 August 25, 2006  
 Trigger Source Geo: 0.500 mm/s  
 Range Geo :31.7 mm/s  
 Record Time 5.0 sec (Auto=3Sec) at 2048 sps  
 Job Number: 1

Serial Number BE10316 V 8.01-8.0 MiniMate Plus  
 Battery Level 6.1 Volts  
 Calibration June 29, 2005 by Instantel, Inc  
 File Name L316BAPU.670  
 Scaled Distance 30.0 (300.0 m, 100.0 kg)

Notes  
 Location:  
 Client:  
 User Name:  
 General:

Extended Notes

Post Event Notes

Microphone Linear Weighting  
 PSPL 106.5 dB(L) at 1.992 sec  
 ZC Freq 9.8 Hz  
 Channel Test Passed (Freq = 20.5 Hz Amp = 427 mv)

	Tran	Vert	Long	
PPV	0.524	0.460	0.651	mm/s
ZC Freq	13.5	15.1	8.5	Hz
Time (Rel. to Trig)	0.083	0.149	0.002	sec
Peak Acceleration	0.0166	0.0133	0.0133	g
Peak Displacement	0.00771	0.00491	0.00990	mm
Sensorcheck	Passed	Passed	Passed	
Frequency	7.5	7.3	7.6	Hz
Overswing Ratio	3.4	3.6	3.6	

USBM RI8507 And OSMRE

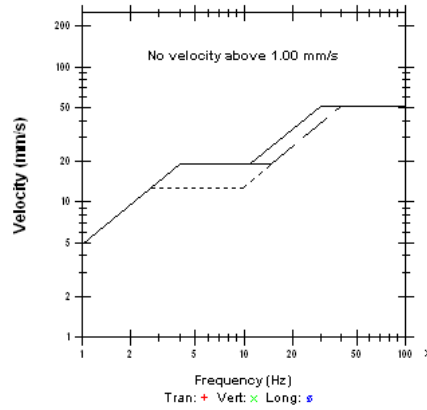

Peak Vector Sum 0.817 mm/s at 0.002 sec

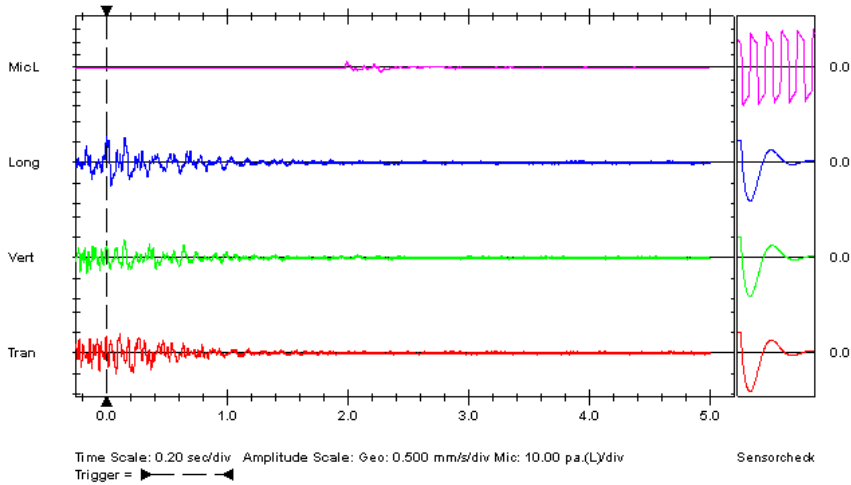

Printed: August 20, 2007 (V 8.01-8.01)

Format Copyrighted 1996-2004 Instantel Inc.

Figure E.16 16th vibration record taken along Katrancilar District path.



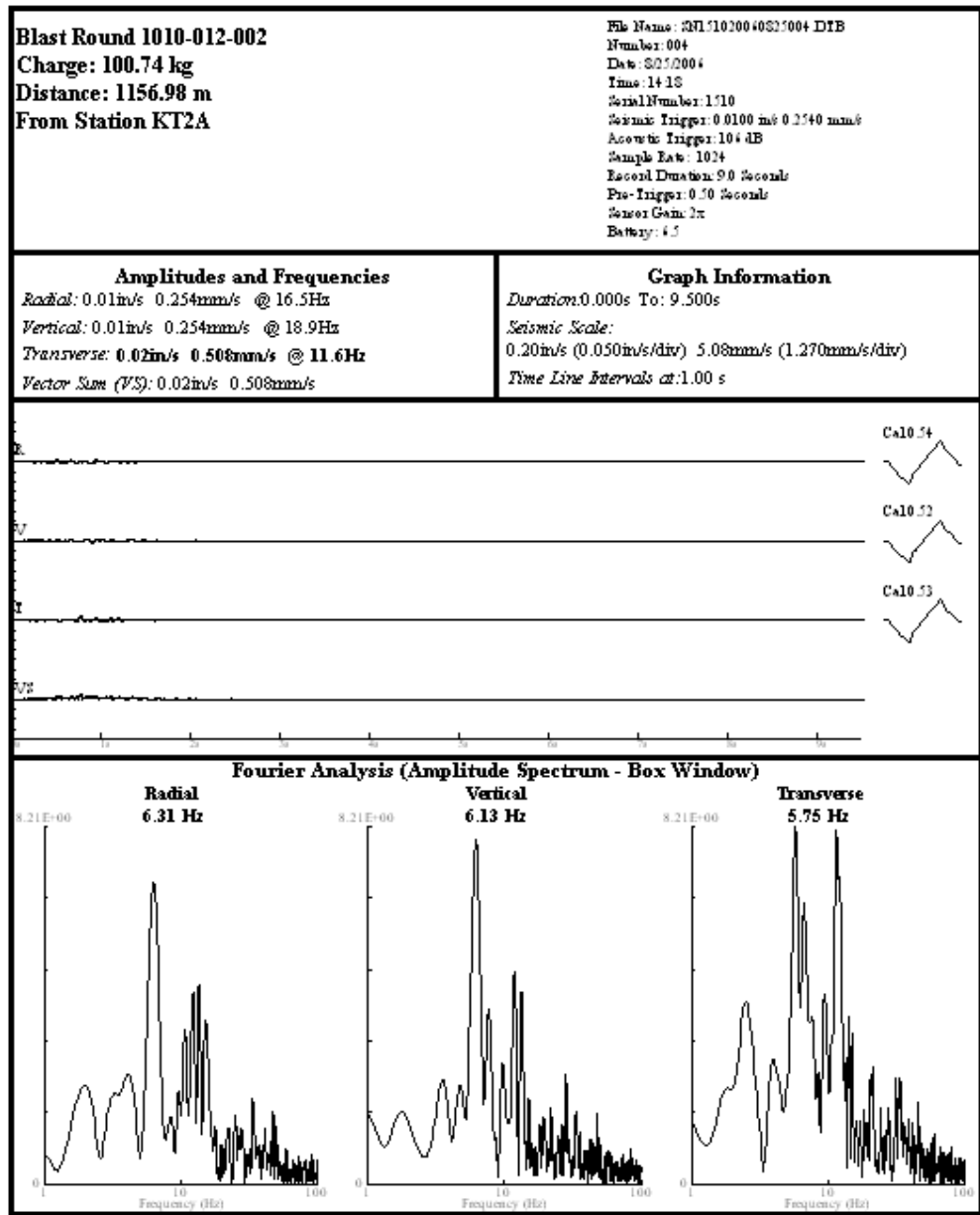
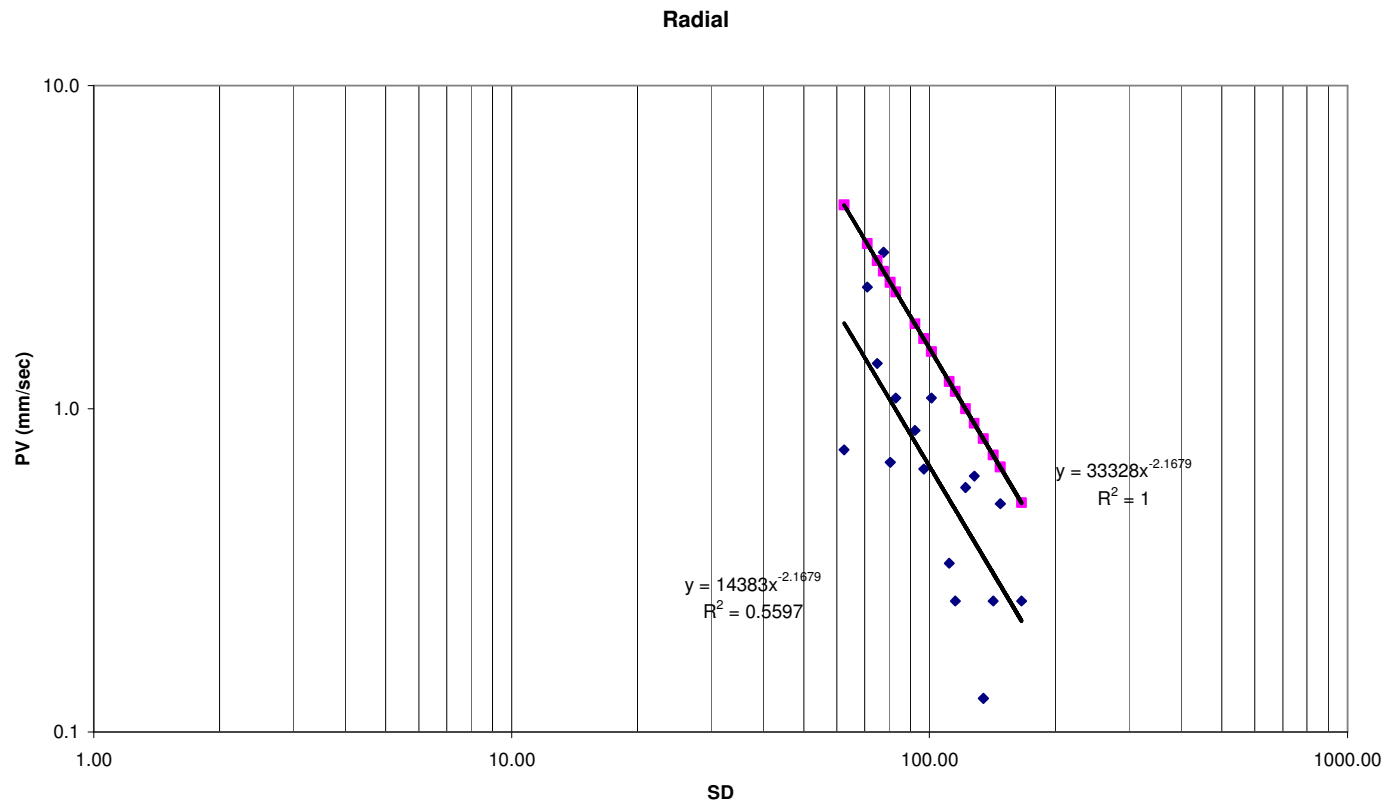
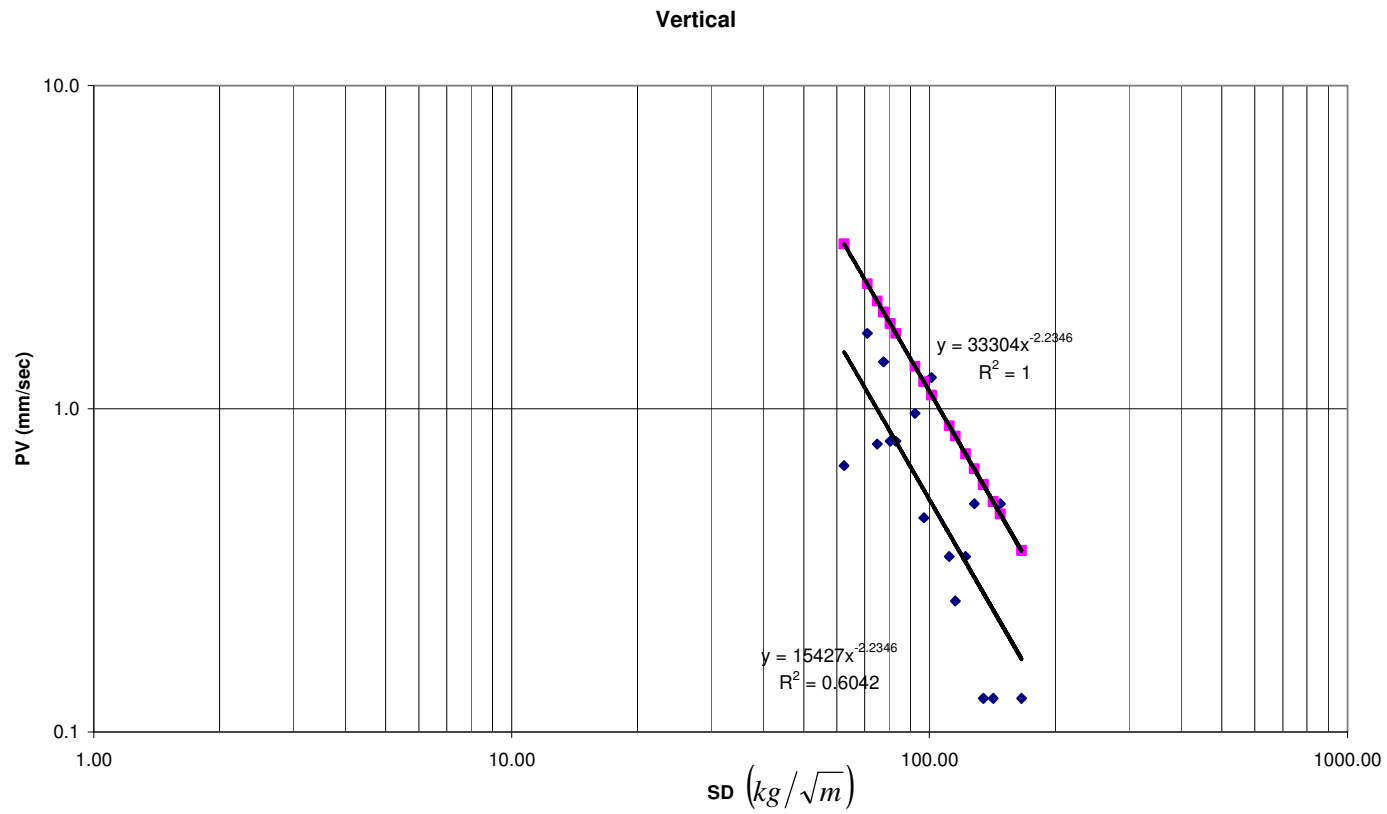

Figure E.17 17th vibration record taken along Katrancilar District path.



**Figure F.1** Scaled distance (SD) – particle velocity (PV) relation measured in longitudinal (R) component along Katrancilar Village path



**Figure F.2** Scaled distance (SD) – particle velocity (PV) relation measured in vertical (V) component along Katrancilar Village path

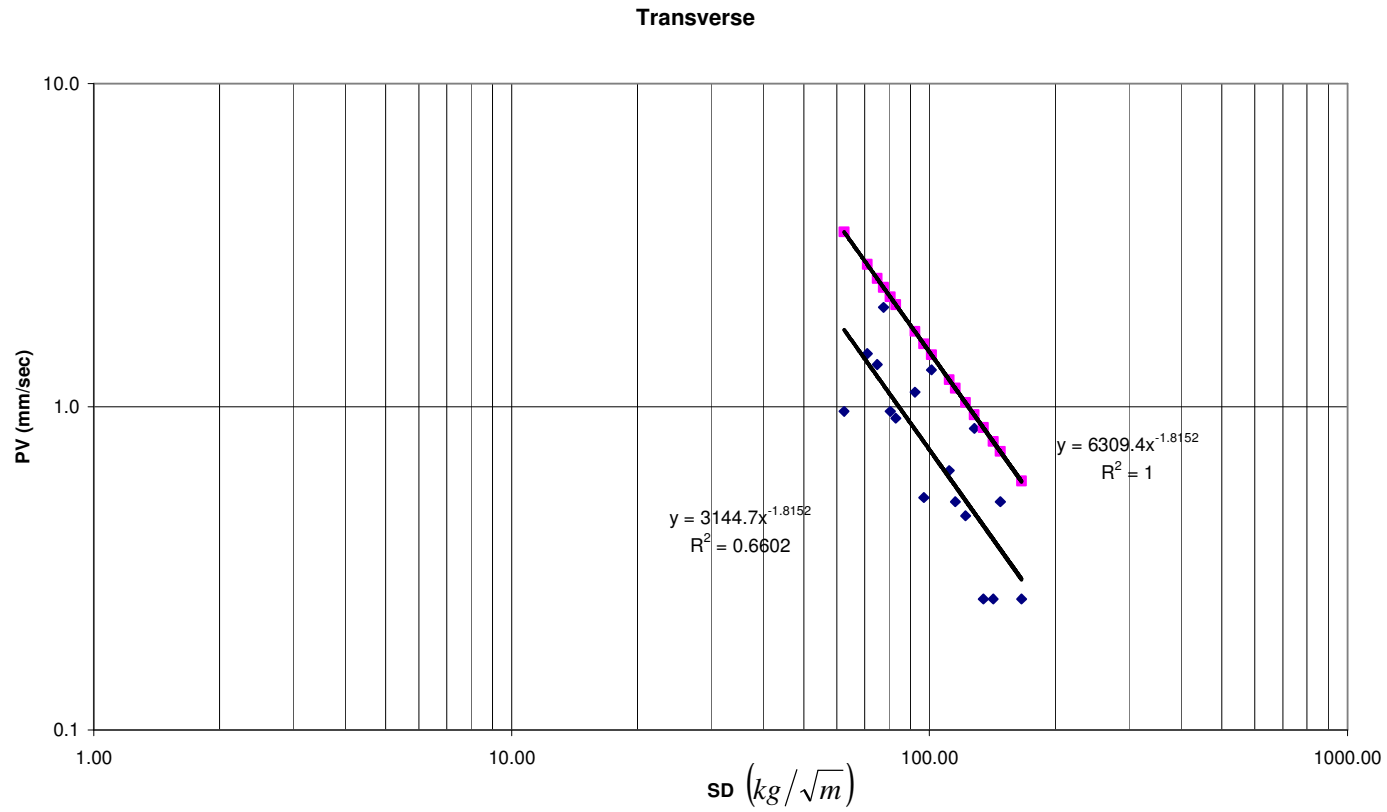

**Figure F.3** Scaled distance (SD) – particle velocity (PV) relation measured in transverse (T) component along Katrancilar Village path

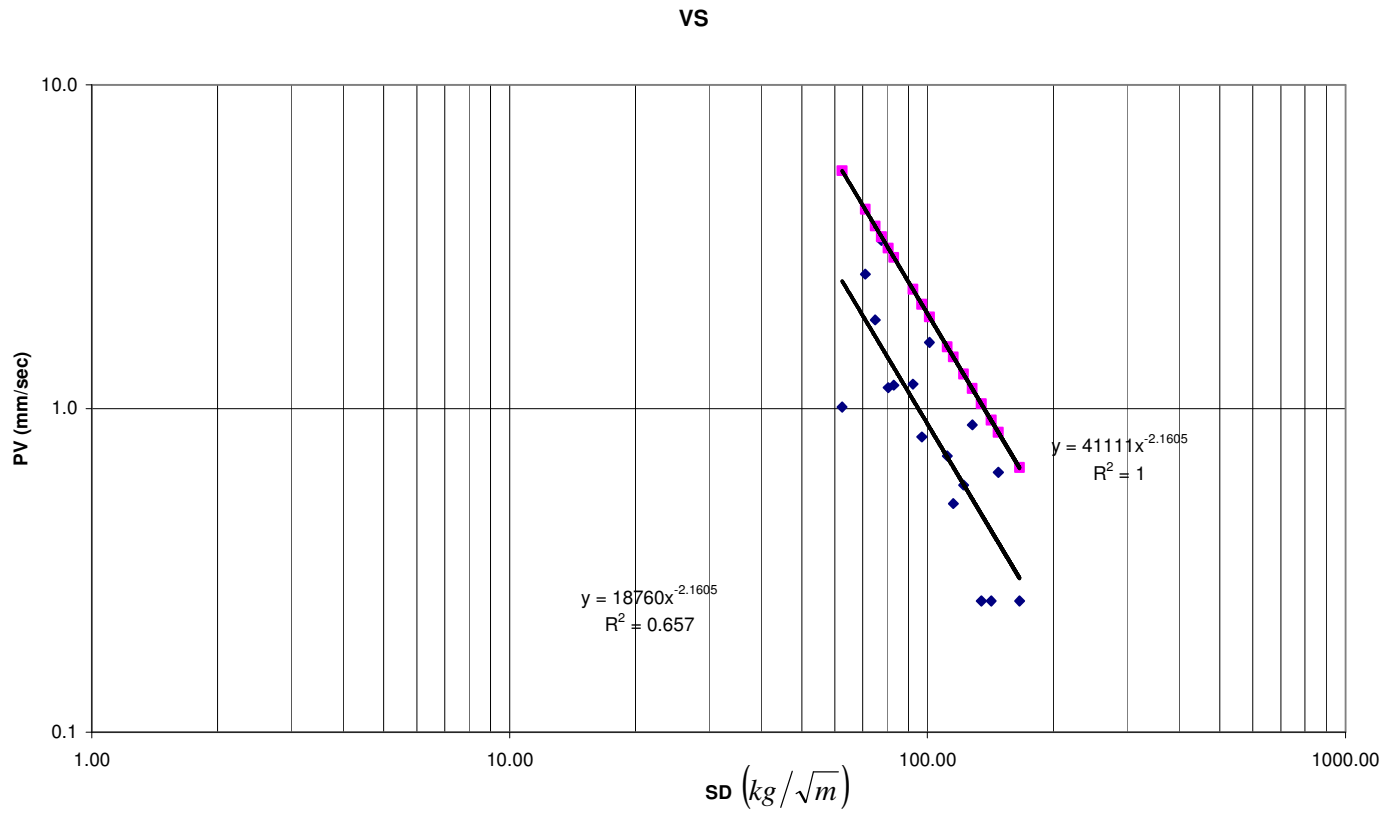

**Figure F.4** Scaled distance (SD) – particle velocity (PV) relation measured as vector sum (VS) along Katrancilar Village path

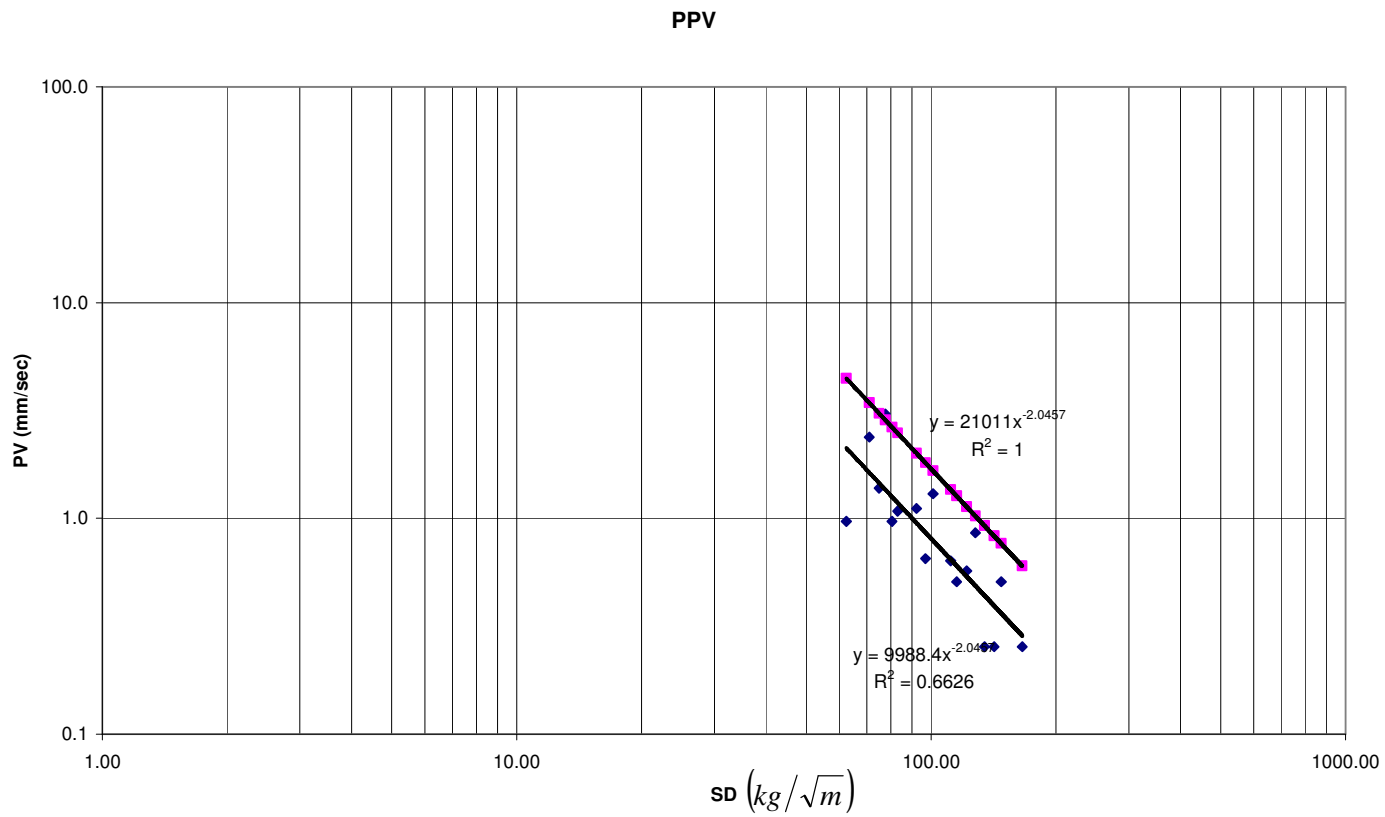

**Figure F.5** Scaled distance (SD) – peak particle velocity (PPV) relation measured along Katrancilar Village path

## APPENDIX G

**Table G.1** Dip directions and dip amounts of 106 discontinuities measured in the pit.

Number	Dip Amount (°)	Dip Direction (N°)	Number	Dip Amount (°)	Dip Direction (N°)
1	74	120	54	67	42
2	57	130	55	82	49
3	69	132	56	60	57
4	71	4	57	83	42
5	69	5	58	83	55
6	72	360	59	90	58
7	72	6	60	84	258
8	65	335	61	84	259
9	57	82	62	87	109
10	66	84	63	85	106
11	66	73	64	84	108
12	89	70	65	87	105
13	58	61	66	86	244
14	76	320	67	86	250
15	75	319	68	85	248
16	78	323	69	81	105
17	75	340	70	82	103
18	74	338	71	88	101
19	77	318	72	84	101
20	73	326	73	84	107
21	86	141	74	82	111
22	83	146	75	80	101
23	87	125	76	68	101
24	76	144	77	69	103
25	86	156	78	58	99
26	55	327	79	64	107
27	47	337	80	73	300
28	58	328	81	62	327
29	53	326	82	65	323
30	55	320	83	62	322
31	62	340	84	61	327
32	61	345	85	64	320
33	60	340	86	61	353
34	61	344	87	65	346
35	77	330	88	54	350
36	88	338	89	70	335
37	76	335	90	77	358
38	82	340	91	46	354
39	89	200	92	71	358
40	84	201	93	58	7
41	77	40	94	64	4
42	84	45	95	68	352
43	78	46	96	57	357
44	81	48	97	63	6
45	57	62	98	56	6
46	57	59	99	55	6
47	54	65	100	53	65
48	63	64	101	55	55
49	53	64	102	66	69
50	50	57	103	64	56
51	57	58	104	66	55
52	53	61	105	70	109
53	62	70	106	72	74

**Table G.2** Dip directions and dip amounts of 83 discontinuities measured at the road cuts along Gümüşkol path.

Record Number	Dip Amount (°)	Dip Direction (N°)	Record Number	Dip Amount (°)	Dip Direction (N°)
1	76	290	43	84	84
2	73	299	44	76	75
3	73	285	45	82	4
4	78	300	46	79	317
5	83	279	47	84	327
6	84	308	48	84	310
7	82	292	49	78	312
8	81	287	50	81	316
9	82	288	51	79	318
10	75	300	52	83	306
11	79	304	53	86	303
12	78	280	54	84	306
13	76	282	55	77	304
14	74	282	56	82	312
15	81	291	57	73	308
16	83	287	58	83	192
17	82	206	59	84	196
18	89	209	60	82	160
19	90	204	61	82	170
20	85	197	62	87	180
21	88	200	63	79	194
22	89	199	64	76	166
23	89	200	65	83	167
24	87	18	66	82	147
25	88	22	67	83	154
26	87	17	68	83	172
27	55	11	69	57	185
28	53	11	70	88	32
29	53	7	71	88	32
30	85	227	72	87	40
31	88	71	73	88	265
32	90	80	74	89	282
33	90	72	75	89	274
34	85	80	76	86	277
35	88	76	77	87	276
36	88	265	78	88	84
37	89	282	79	81	72
38	89	274	80	84	84
39	86	277	81	76	75
40	87	276	82	72	72
41	81	72	83	83	82
42	88	84			