

**SCHEDULING ALGORITHMS FOR WIRELESS CDMA
NETWORKS**

**A THESIS SUBMITTED TO
THE GRADUATE SCHOOL OF NATURAL AND APPLIED
SCIENCES
OF
MIDDLE EAST TECHNICAL UNIVERSITY**

BY

SERKAN ENDER HAKYEMEZ

**IN PARTIAL FULFILLMENT OF THE REQUIREMENTS
FOR
THE DEGREE OF MASTER OF SCIENCE
IN
ELECTRICAL AND ELECTRONICS ENGINEERING**

DECEMBER 2007

Approval of the thesis:

SCHEDULING ALGORITHMS FOR WIRELESS CDMA NETWORKS

submitted by **SERKAN ENDER HAKYEMEZ** in partial fulfillment of the requirements for the degree of **Master of Science in Electrical and Electronics Engineering Department, Middle East Technical University** by,

Prof. Dr. Canan Özgen
Dean, Graduate School of **Natural and Applied Sciences**

Prof. Dr. İsmet Erkmen
Head of Department, **Electrical and Electronics Engineering**

Dr. Şenan Ece Güran Schmidt
Supervisor, **Electrical and Electronics Engineering Dept., METU**

Examining Committee Members:

Prof. Dr. Hasan Güran
Electrical and Electronics Engineering Dept., METU

Dr. Şenan Ece Güran Schmidt
Electrical and Electronics Engineering Dept., METU

Assoc. Prof. Dr. Özgür Barış Akan
Electrical and Electronics Engineering Dept., METU

Assist. Prof. Dr. Ali Özgür Yılmaz
Electrical and Electronics Engineering Dept., METU

Dr. Ülkü Doyuran
ASELSAN

Date: December 4, 2007

I hereby declare that all information in this document has been obtained and presented in accordance with academic rules and ethical conduct. I also declare that, as required by these rules and conduct, I have fully cited and referenced all material and results that are not original to this work.

Name, Last name : Serkan Ender HAKYEMEZ

Signature :

ABSTRACT

SCHEDULING ALGORITHMS FOR WIRELESS CDMA NETWORKS

Hakyemez, Serkan Ender

M.Sc., Department of Electrical and Electronics Engineering

Supervisor: Dr. Şenan Ece (Güran) Schmidt

December 2007, 94 pages

In recent years the need for multimedia packet data services in wireless networks has grown rapidly. To overcome that need third generation (3G) mobile services have been proposed. The fast growing demands multimedia services in 3G services brought the need for higher capacity. As a result of this, the improvement on throughput, traffic serving performance has become necessary in 3G systems. Code division multiple access (CDMA) technique is one of the most important 3G wireless mobile techniques that has been defined. The scheduling mechanisms used in CDMA plays an important role on the efficiency of the system. The power, rate and capacity parameters are variable and dependent to each other in designing a scheduling mechanism. The schedulers for CDMA decide which user will use the frequency band at which time interval with what power and rate. In this thesis different type of algorithms used in time slotted CDMA are studied and a new algorithm which supports Quality of Service (QoS) is proposed. The performance analysis of this proposed algorithm is done via simulation in comparison to selected CDMA schedulers.

Keywords: Keywords: CDMA, Wireless Networking, CDMA Scheduler.

ÖZ

TELSİZ CDMA AĞLARI İÇİN ÇİZELGELEME ALGORİTMALARI

Hakyemez, Serkan Ender

Yüksek Lisans, Elektrik ve Elektronik Mühendisliği Bölümü

Tez Danışmanı: Dr. Şenan Ece (Güran) Schmidt

Aralık 2007, 94 sayfa

Günümüzde telsiz ağlarda sağlanan çoklu ortam paket hizmeti ihtiyacı artmaktadır. Bu ihtiyacı karşılamak için üçüncü nesil mobil iletişim sistemleri geliştirilmiştir. Üçüncü nesilde çoğalan çoklu ortam paket hizmeti ihtiyacı telsiz kanalında daha yüksek kapasite elde edilmesini, trafik servis performansının ve sistem verimliliğinin artırılması gereksinimlerini doğurmuştur. Çizelgeleme algoritmaları bu gereksinimleri karşılamak için geliştirilmiştir. Çizelgeleme algoritmaları kullanıcılara adil bir şekilde, servis kalitesi gereksinimlerini sağlayarak sistem kaynaklarını paylaşmaktadır. Kod Ayrımlı Çoklu Erişim tekniği önemli üçüncü nesil haberleşme tekniklerinden biridir ve çizelgeleme algoritmaları bu tekniğinin veriminin artırılmasında önemli bir yer tutmaktadır. Bu tekniğin doğal yapısından kaynaklanan değişken kanal kapasitesi, güç ve bilgi hızı değerleri nedeniyle çizelgeleme uygulamalarının kaynakları uygun bir şekilde dağıtması sorunsal olmaktadır. Bu nedenle çizelgeleme yöntemleri etkin bir araştırma konusudur. Bu tezde Kod Ayrımlı Çoklu Erişim tekniğinde kullanılan değişik çizelgeleme teknikleri incelenmiş ve önerilen yöntem anlatılmıştır.

Anahtar Sözcükler: Kod Ayrımlı Çoklu Erişim, Çizelgeleme Tekniği, Telsiz Haberleşme Ağları.

To My Family

ACKNOWLEDGEMENTS

I would like to thank Dr. Şenan Ece (Güran) Schmidt for her motivating ideas and valuable guidance.

I would like to thank Güney Özkaya and my colleagues in the test engineering department in ASELSAN Inc for their valuable support.

I would also like to thank my parents for giving me encouragement during this thesis and all kind of supports during my whole education.

Finally, I have very special thanks for my dear Cihan, for her precious support and patience during this thesis.

TABLE OF CONTENTS

PLAGIARISM	iii
ABSTRACT	iv
ÖZ	v
ACKNOWLEDGMENTS	vii
TABLE OF CONTENTS	viii
LIST OF TABLES	x
LIST OF FIGURES	xi
LIST OF ABBREVIATIONS	xiii
CHAPTERS	
1. INTRODUCTION.....	1
2. WIRELESS COMMUNICATION SYSTEMS AND CDMA NETWORKS .	4
2.1 Wireless Communication Systems.....	4
2.2 Multiple Access Techniques	5
2.3 CDMA Communication	8
2.3.1 Spreading Codes	10
2.3.2 3G CDMA Systems	14
3. CDMA NETWORK MODELING	16
3.1 CDMA Network.....	16
3.2 Handover	17
3.3 Time Slotted CDMA Model.....	18
3.4 Propagation Model and Power Control.....	20
3.4.1 Free Space Path Loss	21
3.4.2 Shadowing Loss	22
3.4.3 Small Scale Fading Loss	22
3.4.4 Power Control	24
3.5 Mobility Model	25
3.6 Intercell Interference Model.....	27
3.7 Traffic Model	29

3.8	Summary of the Parameters	35
3.9	Implementation and Performance Evaluation Using Simulation.....	37
3.9.1	OMNET Simulation Environment	37
3.9.2	Confidence Interval	40
4.	SCHEDULERS FOR CDMA NETWORKS	42
4.1	Maximizing the Soft Capacity with Scheduling	44
4.2	Schedulers Proposed In Literature for CDMA.....	50
5.	EVALUATION OF SELECTED PACKET SCHEDULING ALGORITHMS: WISPER AND MPARS.....	53
5.1	Operation.....	53
5.2	Implementation in OMNET++.....	59
5.3	Critics	61
6.	NEW ADAPTIVE CDMA UPLINK RESOURCE SCHEDULER WITH QOS SUPPORT	63
6.1	Scope of the Proposed Algorithm	64
6.2	Description of the Proposed Algorithm	66
6.3	Our Algorithm and the Associated Data Structure	68
6.4	Utilization Improvement	71
6.5	Performance Evaluation	75
6.5.1	Fairness and Service Guarantee	76
6.5.2	Throughput.....	79
6.5.3	Delay Guarantee.....	84
6.5.4	Complexity and Stability.....	86
7.	CONCLUSION	88
	REFERENCES.....	91

LIST OF TABLES

Table 2-1	Parameters of WCDMA and TD-CDMA.....	15
Table 3-1	Voice Characteristics.....	30
Table 3-2	Summary of the Parameters.....	36
Table 4-1	QoS Properties.....	43
Table 5-1	Parameters of WISPER	57
Table 6-1	Service Parameters	75

LIST OF FIGURES

Figure 2-1	FDMA Resource Allocation.....	6
Figure 2-2	TDMA Resource Allocation [17].....	7
Figure 2-3	DS-CDMA Resource Allocation.....	8
Figure 2-4	Spreading of Spectrum	9
Figure 2-5	Spreading of Signal	11
Figure 2-6	Decision Algorithm	12
Figure 2-7	Decision Diagram.....	13
Figure 2-8	WCDMA and TD-CDMA [19]	15
Figure 3-1	Frame and Time Slot	18
Figure 3-2	Time Slot Multi-Code Mode	19
Figure 3-3	Hardware for Multi-Code Mode.....	20
Figure 3-4	Loss Graphs	24
Figure 3-5	Circular Movement.....	26
Figure 3-6	Linear Movement	26
Figure 3-7	Random Movement	27
Figure 3-8	Voice Traffic Structure.....	29
Figure 3-9	Voice Traffic	30
Figure 3-10	Video Traffic	32
Figure 3-11	Email Histogram [8].....	33
Figure 3-12	Email Probability Distribution	34
Figure 3-13	Email Histogram Obtained.....	35
Figure 3-14	CDMA Cell	38
Figure 3-15	Mobile Station	38
Figure 3-16	Base Station	39
Figure 3-17	A Simulation Run.....	41
Figure 4-1	Scheduler in the Base Station.....	42
Figure 4-2	Frame and Time Slot	44
Figure 5-1	Priority List.....	55
Figure 5-2	Slot Accommodation in WISPER	58

Figure 5-3	Throughput Comparison.....	60
Figure 5-4	Problem Illustration	62
Figure 6-1	OMNET Simulation Model for the Proposed Algorithm.....	64
Figure 6-2	Packet Division.....	67
Figure 6-3	Queue Accommodation	68
Figure 6-4	Main Queue	69
Figure 6-5	Capacity	69
Figure 6-6	Flow Diagram.....	70
Figure 6-7	Average Number of Drops	76
Figure 6-8	Average Number of Dropped Users	77
Figure 6-9	Number of Dropped Packets for Guaranteed Flow	78
Figure 6-10	Packet Drop of Video Users with Guaranteed Users in Network	79
Figure 6-11	Throughput of Mixed Traffic	80
Figure 6-12	Throughput of Voice Users Using Proposed Algorithm	81
Figure 6-13	Throughput of Video Users Using Proposed Algorithm.....	82
Figure 6-14	Percentage Throughput for Voice Users	83
Figure 6-15	Percentage of Output/Input for Video Users	83
Figure 6-16	Average Drop	84
Figure 6-17	Delay Graph for Flows	85
Figure 6-18	Jitter Graph for Flows.....	85

LIST OF ABBREVIATIONS

CDMA	Code Division Multiple Access
FDMA	Frequency Division Multiple Access
TDMA	Time Division Multiple Access
SDMA	Space Division Multiple Access
OFDM	Orthogonal Frequency Division Multiplexing
MIMO	Multi Input Multi Output
SNR	Signal to Noise Ratio
BER	Bit Error Rate
QoS	Quality of Service
DARPA	Defense Advanced Research Projects Agency
LAN	Local Area Network
NTT	Telephone Public Corporation
FDD	Frequency Division Duplex
TDD	Time Division Duplex
AMPS	Advanced Mobile Phone Systems
NMT	Nordic Mobile Telephone
GSM	Global System for Mobile
AWGN	Additive White Gaussian Noise
ISI	Intersymbol Interference
RT	Real time traffic
NRT	Non-real time traffic
VBR	Variable bit rate traffic
CBR	Constant bit rate traffic
ABR	Available bit rate
UBR	Unspecified bit rate

CHAPTER 1

INTRODUCTION

In recent years wireless communication systems have grown rapidly with supporting transmission of different data services. After development of packet switch based communication such as the Internet it became possible to transmit data for various types of applications such as e-mail, video and web browsing. The wireless communication services extended from pure voice services to multimedia services which demand higher data rates and higher data sizes so higher bandwidth requirements. Unlike wired communication systems, wireless systems have limited bandwidth due to the noisy time varying channel characteristics, propagation loss of RF (radio frequency) waves, and the limited bandwidth of the channel which do not exist in wired systems. The allocation of resources to multiple users became the bottleneck problem in the wireless communication networks.

In recent years the need for multimedia packet data services has grown rapidly. To overcome that need third generation (3G) mobile services have been introduced. Code division multiple access (CDMA) technique suggested as channel access technology for 3G (and beyond) wireless mobile services. In CDMA users are granted with same frequency at the same time with different orthogonal spreading codes. The other users communicating at the same time creates interference to each other which is the mostly limiting factor of the system capacity. Hence, scheduling mechanisms are required for CDMA systems to use the limited system resources efficiently.

Previously, the scheduling strategy for CDMA was pure code scheduling for circuit switching which allows the admitted users transmit continuously until they finish their communication. This is a simple technique to implement and the delay requirement is always satisfied for users due to continuous transmission. However, today the mobile devices are more frequently used for multimedia applications such as web browsing, video conferencing and the like. The circuit switching model for these traffic types is inflexible and inefficient. The idea of packet switching which is used in the Internet is more appropriate for those applications. Due to that reason the *time scheduling* mechanisms are developed for 3G cellular phone applications. In time scheduling, the time is divided into slots and the scheduler determines which mobile users can transmit in each time slot and the associated power levels. The continuous transmission is divided into packets for the users and in each time slot a number of packets for user are transmitted.

The time schedulers for CDMA systems perform resource allocation using parameters such as the rate of the data packets, the power of the users, the number and type of data packets granted at the same time slot. The capacity of the wireless channel depends on these parameters and the schedulers select the packets to schedule in a time slot to maximize the channel capacity. However, considering the applications and the resource management models in the internet, service differentiation is required among the packets based on traffic features as well as the resource allocation to users. Different types of traffic to be transmitted have different loss rate, delay and delay jitter requirements, For example voice data traffic is more tolerant to bit error rate (BER) requirements; however as it is real time data it has a strict delay bound. In addition, the users might have different service level agreements (SLA) with the service providers.

In this thesis, channel access scheduling with service differentiation and QoS support for time slotted CDMA systems are considered. First selected schedulers from literature are implemented in OMNET simulation environment and their performances are investigated. Then, a new time slotted resource scheduler which adopts the dynamic spreading gain approach to time slotted CDMA systems is proposed and implemented in the same environment. In the proposed algorithm,

traffic is classified into real time, non-real time and guaranteed service classes. Differential treatment is provided to the guaranteed class to support QoS different than the investigated algorithms. Our new algorithm maintains the throughput as in the other investigated scheduling algorithms and improves the throughput slightly under certain traffic scenarios. The performance of the new scheduler is evaluated in comparison to the selected schedulers. Besides the throughput, other QoS performance such as delay and BER requirements are satisfactory..

This thesis is organized as follows:

The second chapter first gives a brief introduction to wireless technology and access techniques in cellular systems such as CDMA, TDMA and FDMA. Then CDMA communication is discussed in detail and the models used for performance analysis to be used in the thesis and OMNET simulation environment are included in the third chapter. The scheduling problem and schedulers for CDMA proposed in the literature are introduced in the fourth chapter. In the fifth chapter the selected schedulers for time slotted CDMA systems are implemented and their performance is investigated. The sixth chapter presents the new resource scheduler proposed in this thesis and its performance evaluation. Last chapter concludes the thesis and outlines future work.

CHAPTER 2

WIRELESS COMMUNICATION SYSTEMS AND CDMA NETWORKS

In this chapter firstly the brief information about wireless communication is given. The historical developments on the wireless communication are presented. Then the chapter continues with the basic cellular concepts to become more familiar with the subject. The multiple access techniques and the cellular network are briefly discussed. After that code division multiple access (CDMA) method is further investigated. The signaling and spreading ideas, power control mechanism are given and then the third generation (3G) CDMA methods that will be simulated through the thesis are given.

2.1 Wireless Communication Systems

Wireless communication is first used by using smoke signals and torches over observation towers. With the first transmission of radio signals by Marconi it became possible to build wireless communication structures [25]. In early times the wireless transmission was made by analog signals. After the improvements on telecommunications area, those analog signals became digitized and coded. Digital signals allowed transmitting bit streams and packets which are the combination of bit streams. This type of communication structure is called packet radio.

The usage of wireless communication is exploited by the cellular phone technology. It was first introduced in AT&T Bell Laboratories and the Nippon Telegraph and

Telephone Public Corporation (NTT) in Japan. The idea of cellular phone is depend on the propagation of electromagnetic waves. As the power of the transmitted signal is reduced by the distance, the interference between users, who are far away between each other, becomes very low. That allows sharing same resources (frequency, time or code) between those users.

Today wireless communication provides services for a wide area of applications. The telecommunication industry is developing and the important part of telecommunication is telephony. The first analog cellular phones are used in Chicago in 1983. The spectrum allocation was 50MHz [21]. This first system was very expensive and could not become popular. The second generation of cellular phones is developed in 1990. The main difference from the first systems was the signaling. The second generation systems were based on digital communication. That difference brought improved communication quality and many advantages such as higher capacity, lower cost, and power efficiency. The first cellular systems were used to transfer only conversation information between users; today the cellular communication applications include web browsing, paging and short messaging, subscriber information services, file transfer, video teleconferencing and such multimedia services. The third generation (3G) cellular systems came up in the response of rising need to offer more multimedia services and higher data rates. Universal Mobile Telecommunications System (UMTS) is the new 3G mobile communication system defined by the International Mobile Telecommunication (IMT-2000). One advantage of UMTS is to support 2G mobile services. The main IMT-2000 standardization effort was to create a new air interface that would increase frequency usage efficiency. Wideband CDMA (W-CDMA, backward compatible with GSM and IS-136) is supported by the Third Generation Partnership Project 1 (3GPP1) and cdma2000 (backward compatible with cdmaOne) supported by the Third Generation Partnership Project 2 (3GPP2) [23].

2.2 Multiple Access Techniques

In cellular communication systems users share the same radio resources. Techniques such as are Time Division Multiple Access (TDMA), Frequency

Division Multiple Access (FDMA), Space Division Multiple Access (SDMA) and Code Division Multiple Access (CDMA) are developed for organizing the multiple access from the users.

In FDMA the spectrum is divided into non-overlapping sub frequency bands and those bands are allocated to individual users. Users can not transmit signal within other bands. Also to reduce interference guard bands are allocated to sub frequency bands. FDMA multiplexing technique is used in radio and television broadcast and in first generation analog cellular phones such as Advanced Mobile Phone Systems (AMPS), Nordic Mobile Telephone (NMT). Also multiple access in Orthogonal Frequency Division Multiplexing (OFDM) systems implements FDMA by assigning different subcarriers to different users. FDMA spectrum allocation can be seen in **Figure 2-1**.

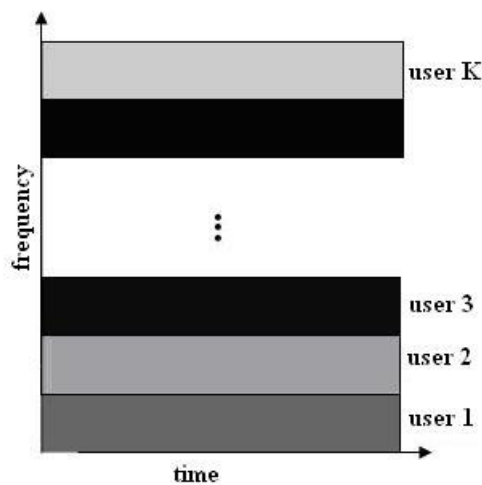

Figure 2-1 FDMA Resource Allocation

In TDMA technique users are allocated the same frequency band but at different time intervals. Those intervals are called time slots and they have equal size. Each user is allowed to transmit using the entire spectrum during a given time slot, but is not allowed to transmit during other time slots when other users are transmitting. TDMA multiplexing technique is used in second-generation cellular systems such

as Global System for Mobile (GSM), in the IEEE 802.16 wireless standards and in Bluetooth networks. TDMA spectrum allocation can be seen in **Figure 2-2**.

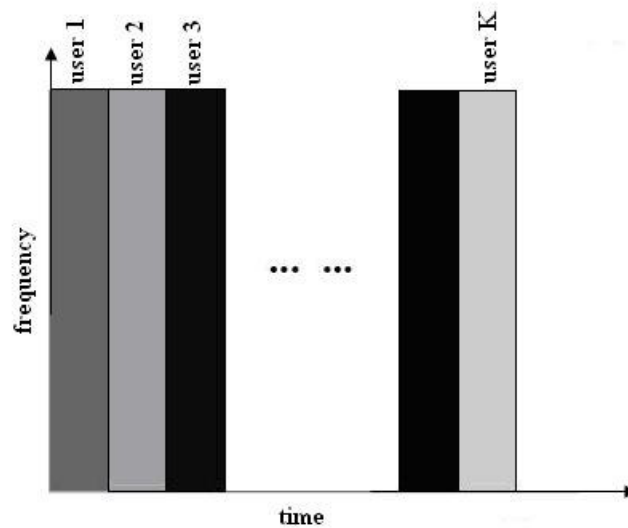

Figure 2-2 TDMA Resource Allocation [17]

In CDMA technique the users share the same available frequency band at the same time frame. The separation of the transmitted signals from different users is achieved by the use of a unique code. CDMA is implemented by a spread-spectrum modulation, in which the transmitted signal is formed by multiplication of the original signal with a pseudorandom code sequence. In such systems each user is assigned a pseudo-random code. CDMA spectrum allocation can be seen in **Figure 2-3**.

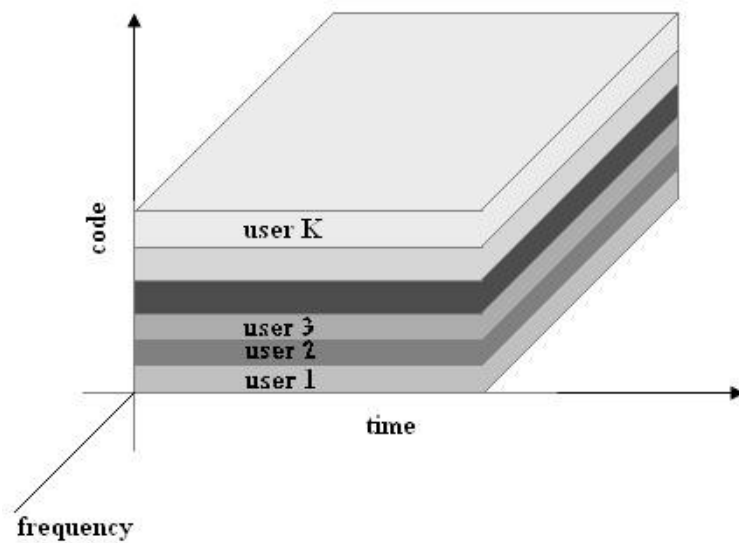

Figure 2-3 DS-SS-SSMA Resource Allocation

In addition to those multiplexing systems spatial techniques are also exists. SDMA systems use angular space diversity [17]. Thus, in SDMA systems the resource allocated to users is the physical space that users cover. Beam forming and space-time coding can be examples for this type. In cellular networks directional antennas are used to divide the coverage into smaller parts such that the transmitted signals from divided areas will not interfere with each other. Multi-input and multi-output (MIMO) systems are examples to SDMA techniques.

2.3 CDMA Communication

Code division multiple access (CDMA) is a multiple access technique where different users share the same frequency band, at the same time. The main property of CDMA is the modulation technique it uses. CDMA uses the spread spectrum technique, in which the narrowband signal is spread through a wider band by using a unique code sequence. Different users can be identified and demodulated at the receiver by the help of those unique code sequences [25].

Origin of spread spectrum techniques starts with military communication applications. Spread spectrum means increasing the signal bandwidth more than

necessary bandwidth for a communication with a given data rate (**Figure 2-4**). As a result of spreading transmitter power over a wider band causes decreasing of the power spectral density (PSD) of the main signal. The reduction in the PSD can be larger so that the signal can sink below the noise floor. That makes the signal difficult to detect.

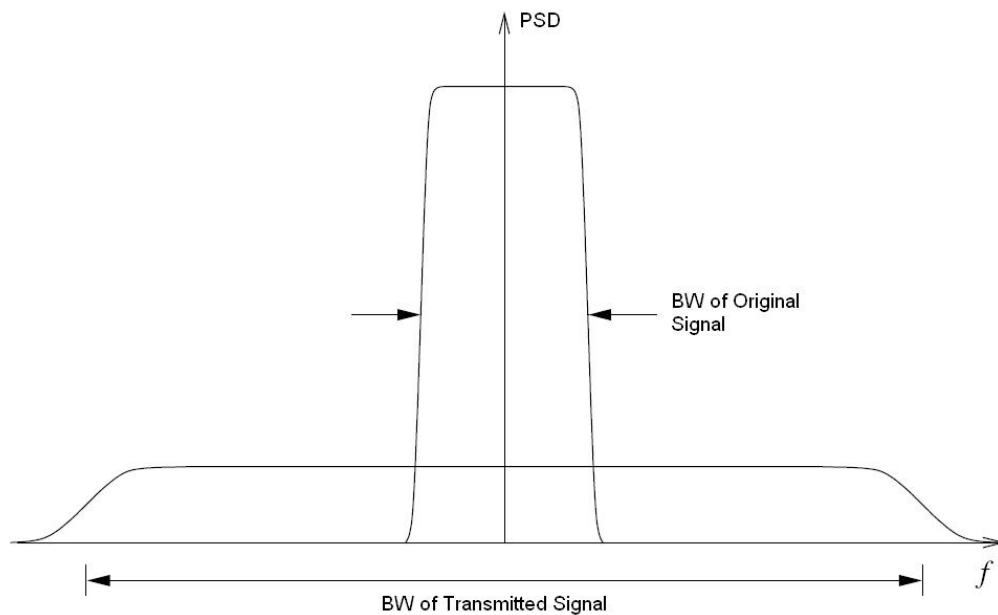

Figure 2-4 Spreading of Spectrum

In spread spectrum, unique code sequences which are independent of the main signal are used at the transmitter and when those code sequences are known at the receiver the transmitted signal can be recovered. Multiplication of the signal with a code sequence makes the communication more secure thus gives more privacy when there are other listeners and makes the communication more resistant to jamming. Also by the help of unique codes multiple transmitted signals can be superimposed on the top of each other and then can be demodulated with minimum interference. Due to that property multiple users can use the common frequency bandwidth at the same time.

There is another advantage of the spread spectrum communication. Spread spectrum with help of a RAKE receiver, can provide coherent combining of different multi-path components. This reduces the effects of self interference due to multi-path propagation. The narrowband interference resistance and ISI (intersymbol interference) rejection capabilities of spread spectrum are very desirable in cellular systems and wireless LANs. As a result, spread spectrum is the basis for both 2nd and 3rd generation cellular systems as well as 2nd generation wireless LANs.

There are three forms of CDMA system: direct sequence (DS), time hopping (TH) and frequency hopping (FH) [16]. In direct sequence system the user signal is spread through a wider bandwidth by the spreading sequence and then upconverted by carrier frequency and transmitted. TH-CDMA looks like DS-CDMA except the users transmits communicated data in time intervals assigned to them. The time is divided into frames and each frame is divided into time slots. The code assigned to users determines the time slot that the user allocates. In each frame a user can allocate one time slot. In TH-CDMA the data of the user is passed more quickly than the other techniques. The same amount of data is transferred in a time slot instead of the time frame. Due to that reason bandwidth increases with $W'=W.N$ where W is the bandwidth and N is the number of slots in a frame. The carrier frequency for all users is the same in DS-CDMA however in FH-CDMA the carriers are changed between users thus frequency band is divided into frequency slots. Spreading codes determine the frequency slot for transmission. This hopping brings difficulties in coherent demodulation; keeping phase smooth is hard in FH-CDMA.

2.3.1 Spreading Codes

The increase of the signaling clock period from T_s to T_c increases the bandwidth with a factor of $G=T_s/T_c$. The factor G is called spreading factor or the processing gain of the signal. The spreading code bits are usually referred to as chips and $1/T_c$ is called the chip rate. When the data signal is spread by the code signal the result

the same as code sequence if the data signal is 1 and the result is the inverse of the code sequence if the data signal is 0 (**Figure 2-5**).

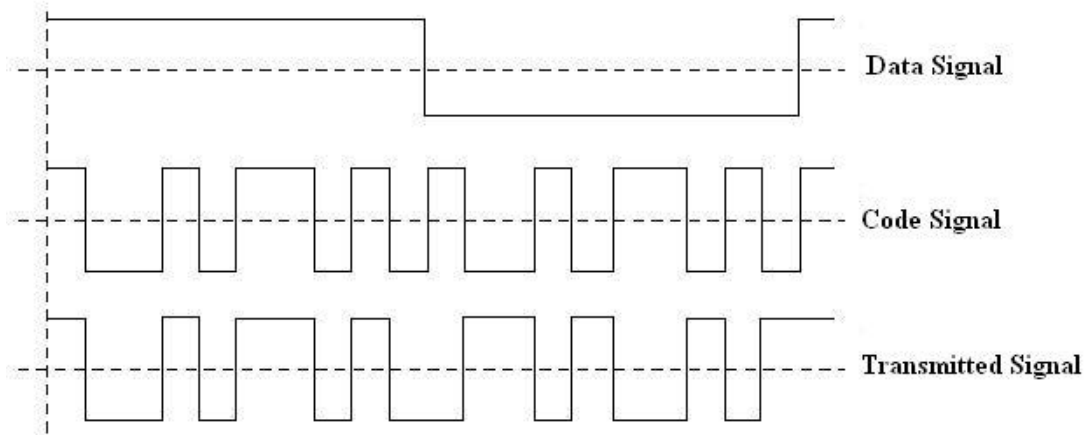

Figure 2-5 Spreading of Signal

Assume we have a data signal as:

$$0 \ 1 \qquad (2-1)$$

And a spreading code as:

$$0 \ 1 \ 0 \ 0 \qquad (2-2)$$

After multiplication of data and spreading code we have:

$$1 \ 0 \ 1 \ 1 \ 0 \ 1 \ 0 \ 0 \qquad (2-3)$$

To resolve the data back in the receiver the algorithm seen **Figure 2-6** can be used.

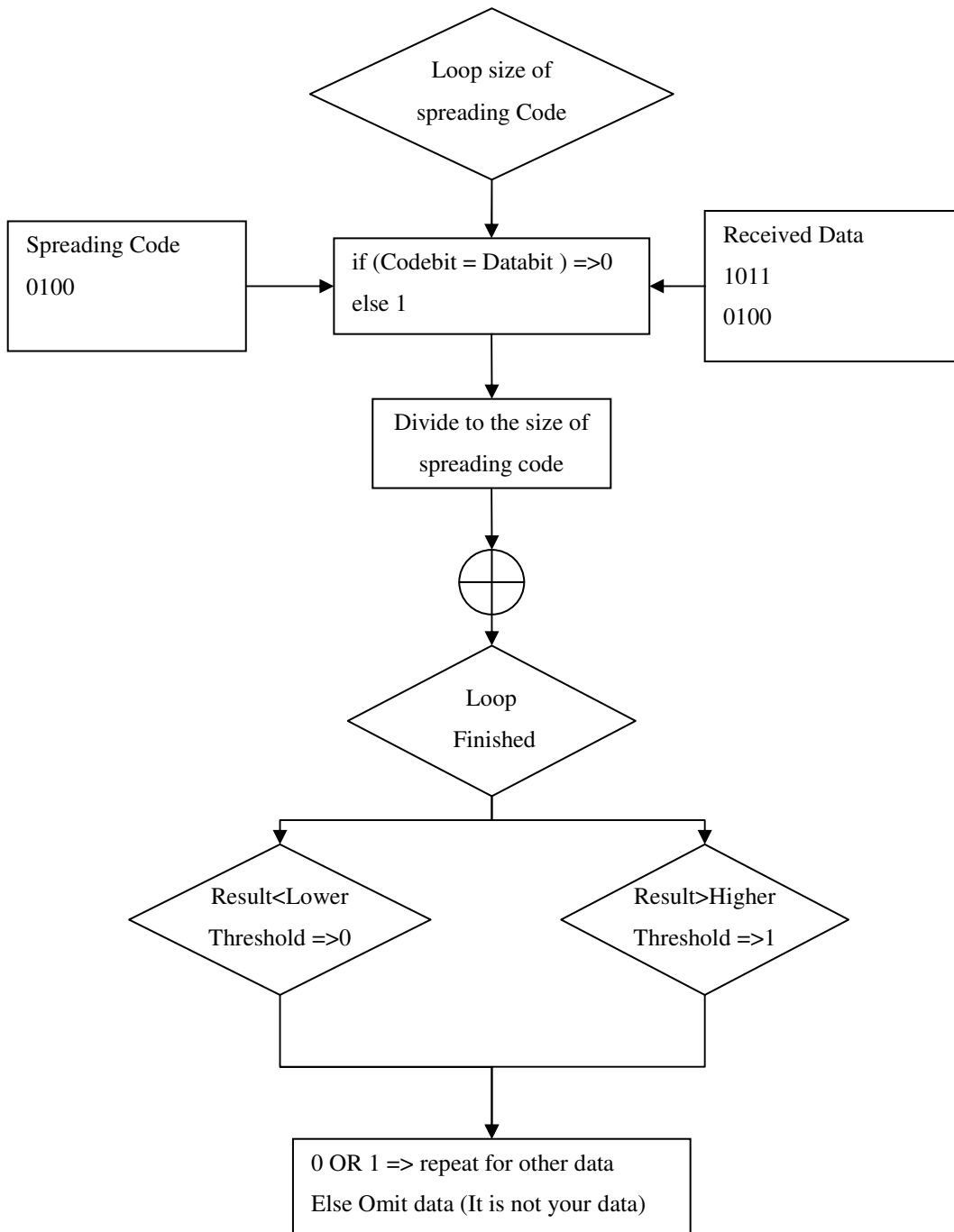

Figure 2-6 Decision Algorithm

Also assume received data is tried to be solved by another spreading sequence such as:

$$1 \ 0 \ 0 \ 1 \quad (2-4)$$

The results of solving the received data with true code and with false code can be seen **Figure 2-7**.

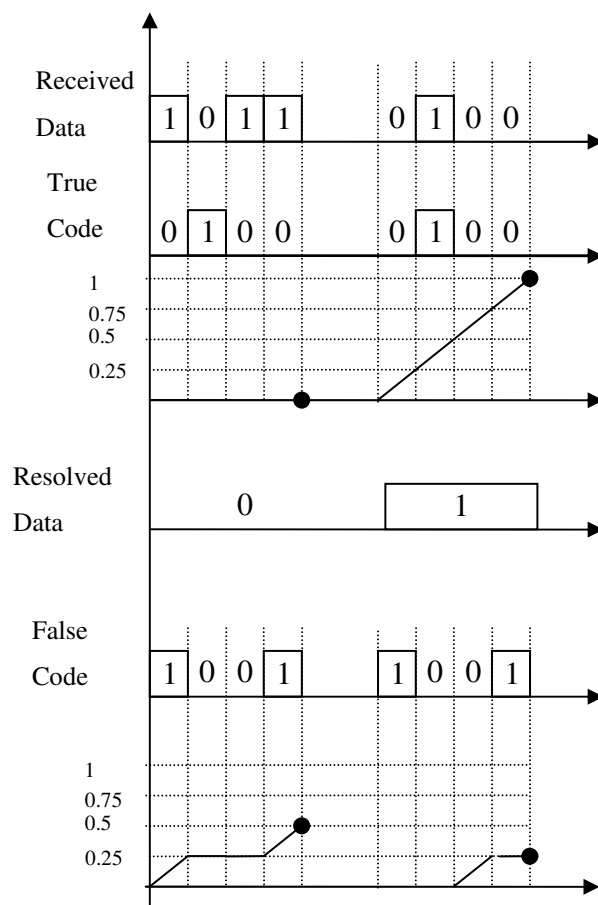

Figure 2-7 Decision Diagram

Using false code, the algorithm finds the result as 0.5 for the first data and 0.25 for the second data. If the thresholds are properly selected including bit errors the

decision can not be given and the false data can be omitted. This is the main principle in CDMA technique. It must be stated that the length of spreading code is important for resolving the data. In above example the spreading code length was 4 if this value is increased there will be more correlation checks between code and the received signal and the result of correlating code and received signal will be more smooth and the threshold arrangements will be more correct.

Generation of spreading codes is important because its autocorrelation properties determine the multipath rejection capability of communication and its cross-correlation properties determines the interference between users. Orthogonal codes are used to overcome the mutual interference between users.

2.3.2 3G CDMA Systems

The European Telecommunications Standards Institute–Special Mobile Group (ETSI SMG) has agreed on a radio access scheme for third generation mobile radio systems, called Universal Mobile Telecommunications System (UMTS) [27]. UMTS consists of two types. The W-CDMA air interface was selected for paired frequency bands and TD-CDMA for unpaired spectrum. The main difference between W-CDMA and TD-CDMA is the duplexing technique used for uplink and downlink signaling. W-CDMA uses FDD and TD-CDMA uses TDD method (**Figure 2-8**). TD-CDMA is based on a combination of Time Division Multiple Access (TDMA) and CDMA, whereas WCDMA is a pure CDMA-based system.

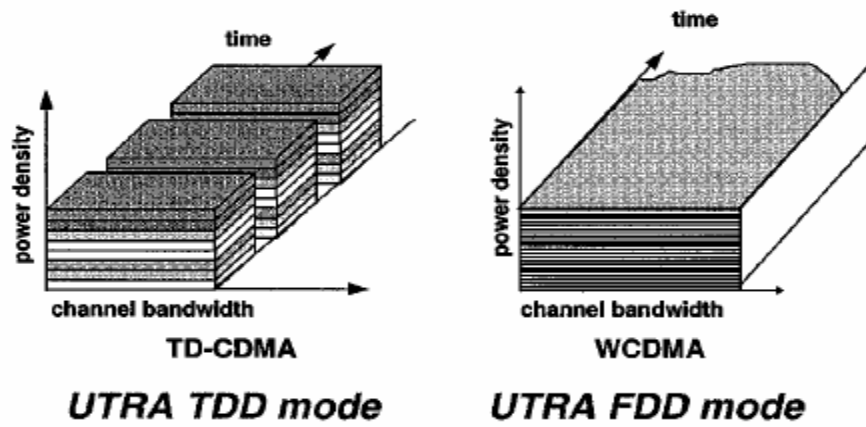

Figure 2-8 WCDMA and TD-CDMA [19]

The parameters of both systems are given in **Table 2-1**

Table 2-1 Parameters of WCDMA and TD-CDMA

Duplex Scheme	FDD	TDD
Multiple Access Scheme	WCDMA	TD-CDMA
Chip Rate	3.84 Mchips/s	
Modulation	QPSK	
Bandwidth	5MHz	
Pulse Shaping	Root Raised Cosine $r=0.22$	
Frame Length	10ms	
Number of Time Slots Per Frame	15ms	

CHAPTER 3

CDMA NETWORK MODELING

The channel capacity of the wireless CDMA networks depends on multiple time-varying parameters different than the wired networks. These parameters have to be modeled as well as the user traffic when the performance of the network and the schedulers are investigated. In this chapter, the models for CDMA network and user traffic adopted in the thesis are presented followed by a summary of the models that we implement and their parameters. We also present the OMNET++ simulation environment.

3.1 CDMA Network

CDMA Network is divided into cells and each single cell consists of one base station located at the center of the cell. The users within a given cell communicate with the base station and the base station is connected to a switching office which acts as a central controller. Those controllers are called Base Station Controller (BSC) in GSM or Radio Network Controller (RNC) in UMTS. BSC/RNC centers take care of coordination (handoff processes, frequency allocation) between base stations (BS). Data from base station is passed over BSC/RNC centers to the Mobile Switching Center (MSC). These MSC centers switch the data from one BSC/RNC centers to other and also help to reach Internet backbone. Finally the data is switched from BSC/RNC centers to base station and from base station to mobile stations (MS). The data transfer procedure from a base station to the mobiles in its cell is called the downlink (DL) and the transfer procedure from the mobiles in a cell to the cell base station is called the uplink (UL) of the cell.

The dimensions of a cell are limited by the transmitter and receiver performances, due to that reason the coverage area is divided into non overlapping cells and the same resources (frequency channels or assigned codes) are used in the cells [24]. The size and the shape of the cells change due to geographical properties, accessing techniques, base station power and the like.

Cell shapes are used to approximate a uniform received power around the base station. Propagation in free space is constant along a unit circle. Due to that factor the cell shape should be approximation of circle. With a hexagon cell shape cells that are laid next to each other without a gap and they cover the entire geographical region. The size of the cell depends on the effects of propagation.

If the size of a cell is decreased users can communicate with better quality. Therefore the capacity of a cell is increased. But the smaller cells bring hand off problems. The rate which hand offs is made increases, also the frequency or code allocation begins complex with increased number of cells in same area.

During the thesis the uplink model of a single cell is assumed. In the cell there is one base station and a number of mobile stations. The cell is assumed to be a square with side length of 100m.

3.2 Handover

Handover or handoff process happens when a mobile moves from one cell to another. Decision of handover depends on the level of received power. If the received power is more in the other cell than the call of the mobile must be handed off from the base station in the original cell to the base station in the new cell. Handover between cells is coordinated by the MSC The handover procedure takes place when the signal quality of a mobile to its base station decreases below a given threshold. This occurs when mobile moves between cells and this can also happen due to increment in the propagation loss within a cell. If no neighboring base station has available channels or can provide an acceptable quality channel then the handover attempt fails and the call will be dropped. There are two types of handovers. Hard handover procedure is applied in GSM networks. Mobile station

releases the old channel before connecting to the new base station via the new channel. Therefore there is a short interruption of the connection. However soft hand over used in CDMA systems the mobile station does not drop the old base station and communicates with both stations at the border. That smooth transition prevents an interruption in the communication. We assume single cell network and we do not implement the handover process in this thesis.

3.3 Time Slotted CDMA Model

In this thesis, we study time slotted multi-code CDMA. In the time slotted CDMA model, the time is first divided into fixed *time slots* and then organized into fixed duration frames similar to TDMA. Scheduler gets the required parameters from the users in each frame and makes decisions for the following frame. Then the frame rate can be called as the refresh rate of parameters and decisions taken from the scheduler. Time slots are the time divisions which multiple users can communicate. The users can transmit in different time slots as seen:

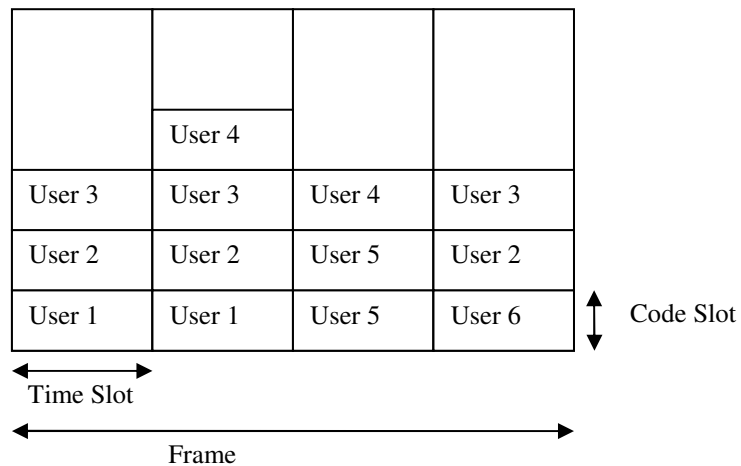

Figure 3-1 Frame and Time Slot

The length of the frame and the number of slots in a frame are design parameters of schedulers. In most applications the length of one time slot is designed such that one packet of voice user is sent in one frame. A time slot consists of *code slots* each of which is assigned to a different spreading code.

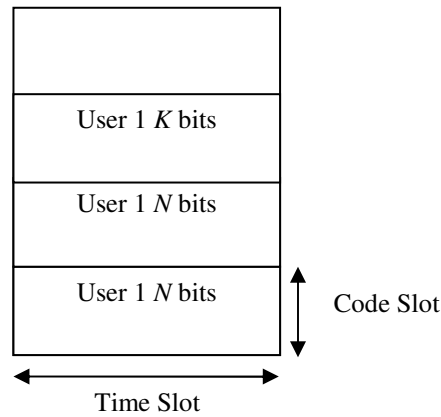

Figure 3-2 Time Slot Multi-Code Mode

In multi-code CDMA, a user can be assigned different spreading codes and send multiple packets in the same time slot. With multi-code operation higher data rates for a user can be achieved. R_s is called the basic stream rate.

Current CDMA protocols, supports multi code assignment to the same user at the same time interval. The hardware structure for those CDMA receivers is given in the below figure.

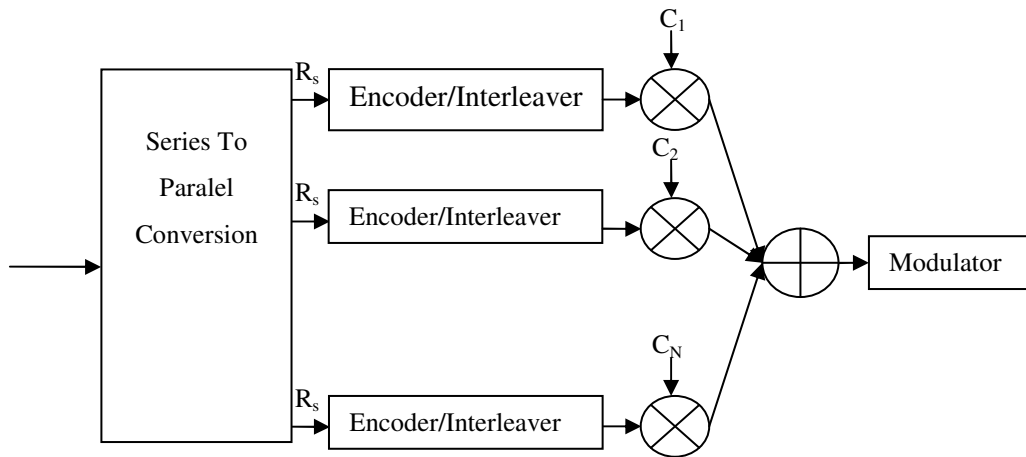

Figure 3-3 Hardware for Multi-Code Mode

3.4 Propagation Model and Power Control

The transmitted signal loses its energy on its path to the receiver. In CDMA the near-far problem and interference from other users requires a power control mechanism. The users in bad channel condition should not get shares from the system resources. The scheduler needs to know the condition of the users to decide they will communicate or not and to calculate it will transmit at which power [12].

Prorogation model consists of two types of fading: large-scale and small scale-fading. Path loss in free space and attenuation due to buildings, trees and the like are called large-scale fading. Small-scale fading results large dynamic variations in the received signal amplitude and phase as a result of very small changes in the spatial separation between the transmitter and the receiver [17].

The propagation model is the sum of two fading. Large scale fading is composed of free space loss and shadowing. So the path loss is:

$$P_l = P_s + P_f + P_{sf} \quad (3-1)$$

Where P_f is the free space loss and P_s is the shadowing loss and P_{sf} is the small scale fading loss.

3.4.1 Free Space Path Loss

In the free space loss model it is assumed that there are no objects in the line of sight (LOS) of transmitter and receiver antenna. The signal from the transmitter travels through a distance d and arrives at receiver antenna. The transmitter and receiver antenna gain factors can be written as [17].

$$G_t = G_r + G_r \quad (3-2)$$

If the transmitted power is P_t and the received power is P_r and the wave length of the signal is λ than it can be written:

$$\frac{P_r}{P_t} = \left(\frac{\lambda \sqrt{G_t}}{4\pi d} \right)^2 \quad (3-3)$$

So the path loss in dB scale is equal to:

$$P_L = 10 \log_{10} \frac{G_t \lambda^2}{(4\pi d)^2} \quad (3-4)$$

In our simulation studies simplified path loss model is used as described in [17]. The γ is the path lost exponent obtained by empirically which is distributed randomly over 2.7 and d_o is the antenna near field parameter assumed as 1m. The path formula is:

$$P_L = 20 \log_{10} \frac{\lambda}{(4\pi d_o)} - 10\gamma \log \frac{d}{d_o} \quad (3-5)$$

We get the path loss variation with distance as given in the **Figure 3-4-a** when we compute the path loss according to the equation above.

3.4.2 Shadowing Loss

In free space loss model it is assumed that there are no obstacles in the Line of Sight (LOS) of transmitter and receiver. However a signal transmitted on a wireless channel face different random obstructions. Those objects such as reflecting surfaces, scattering bodies or non-scattering surfaces adds random variations to the received power. The effects can strengthen the signal as well as they weaken it. The most common model for this additional attenuation is log-normal shadowing. The attenuation of the signal when it passes through an object of depth d is given:

$$s = e^{-\alpha d} \quad (3-6)$$

α is the attenuation constant and changes due to the physical properties of the material and the depth d can be selected as a uniform random variable. The total loss will be the sum of all shadowing effects.

$$P_s = \sum_i s_i \quad (3-7)$$

If there are many materials in the LOS by the help of central limit theorem the equation above converges to a zero mean Gaussian random variable with mean σ which lies typically from 4 dB to 10 dB. If a shadowing pattern is plotted with variance of 3.65 [29] we will get the **Figure 3-4-b**

3.4.3 Small Scale Fading Loss

In a wireless channel there can be more than one path that signal travels between transmitter and receiver. Assume $h(\tau, t)$ is the complex lowpass equivalent impulse response of the channel at time t .

$$c(\tau, t) = \sum_{k=1}^{N(t)} a_k(t) \delta(\tau - \tau_k(t)) \quad (3-8)$$

$N(t)$ is the number of delay components and $a_k(t)$ is the attenuation and τ_k is the delay at time t . The random changes in the received signal can be treated like a

random process and if the number of multipath delays components are large that the small scale fading can be approximated to a Gaussian distribution.

$$H_N(f, t) = \frac{1}{\sqrt{N}} \sum_{k=1}^N e^{j\theta_k} e^{j2\pi v_k t} e^{-j2\pi f \tau_k} \quad (3-9)$$

θ_k is the random phase, V_k is the Doppler spread and τ_k is the delay spread. The phase fluctuations are caused by the movement of the mobile due to time selectivity of the channel and random delays occurred in the channel due to frequency selectivity of the channel. The first one is called Doppler spread and can be written as:

$$\phi_{doppler} = V_m \cos(\theta_{ao}) / \lambda \quad (3-10)$$

The θ_{ao} is the angle of arrival of the signal, V_m is the mobile speed and λ is the wavelength of the signal.

The second type phase fluctuations are called delay spread. It can be written as

$$\phi_{delay} = f \times d \quad (3-11)$$

d is a random variable with exponential distribution and f is the frequency of the signal. By combining delay and Doppler spread the phase fluctuations can be found.

$$\phi = 2\pi(\phi_{doppler} \times t - \phi_{delay}) \quad (3-12)$$

The delay spread is exponentially distributed with a mean of uniform distributed variable between 15 μ s 20 μ s. The number of fading paths is taken 20 for the simulation [29]. The fading pattern with random angle of arrivals and 20 fading paths are plotted in the below figure. The total loss is the sum of those three vectors:

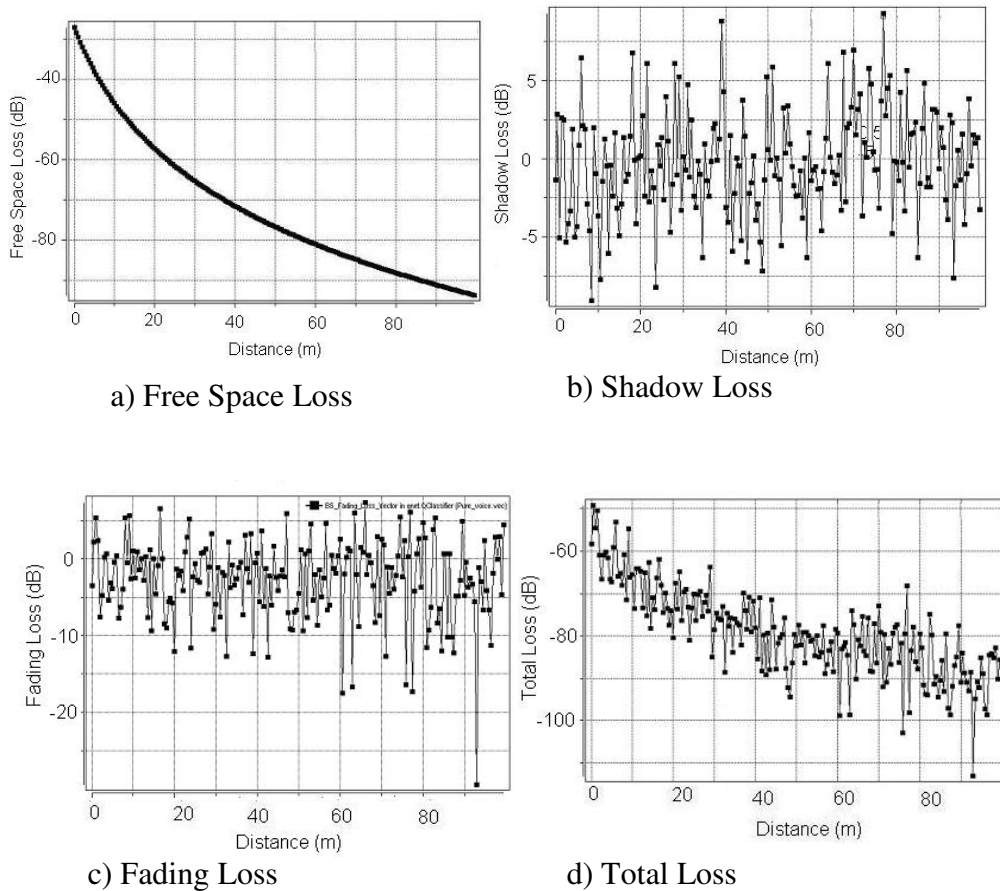

Figure 3-4 Loss Graphs

3.4.4 Power Control

A non-orthogonal CDMA scheme also requires power control in the uplink to compensate for the near-far effect. The near-far effect arises in the uplink because the channel gain between a user's transmitter and the receiver is different for different users. Specifically, suppose that one user is very close to his base station or access point, and another user very far away. If both users transmit at the same power level, then the interference from the close user will create lots of interference to the signal from the far user. Therefore power control is used to equalize the received powers from the all of the users. There are two type of power controlling

schemes: open-loop power control and closed-loop power control depending on whether feedback is used. In open-loop power control, the transmitter changes the transmitted power against the channel's path loss. The path loss is calculated at receiver by the help of pilot symbol channel. Closed-loop is based on SNR measurements from every frame time. Measured and desired SNR are compared and the result is sent to the transmitter.

Open-loop power control is simpler than the closed-loop power control. In open-loop power control, the receiver collects the received signal strength in the pilot channel transmitted from the base station and adjusts its transmit power. This scheme is slow and fails for fast fading and also becomes inaccurate for multipath effects. Because multipath effect on pilot channel is different from the data channel also multipath fading effects on the uplink and downlink frequencies are generally uncorrelated.

In closed-loop power control the receiver feeds back channel quality information or direct power control commands whether the mobile should increase or decrease power by some fixed amount. Power control can be based on various channel quality indicators, but the most common is received signal strength. The base station receiver measures the received signal power, compares the value to a stored threshold, and sends back to indicate whether the mobile should increase or decrease power by some fixed amount.

3.5 Mobility Model

The mobility model describes the distance between base station and user and the speed of the users. Those parameters are important for calculating path loss, calculating multi path fading loss and applying power control. Mobility model assumes a constant speed for the user and the direction of the user advances in time. The model assumes 2D space in the cell where the cell size is specified. The random mobility idea in [13] is used for the model. The initial values for where the user is located in the cell and the velocity of the user are chosen due to a uniformly

distributed function. The X-Y axis movement graphics is shown below for the current model. The values are in meters.

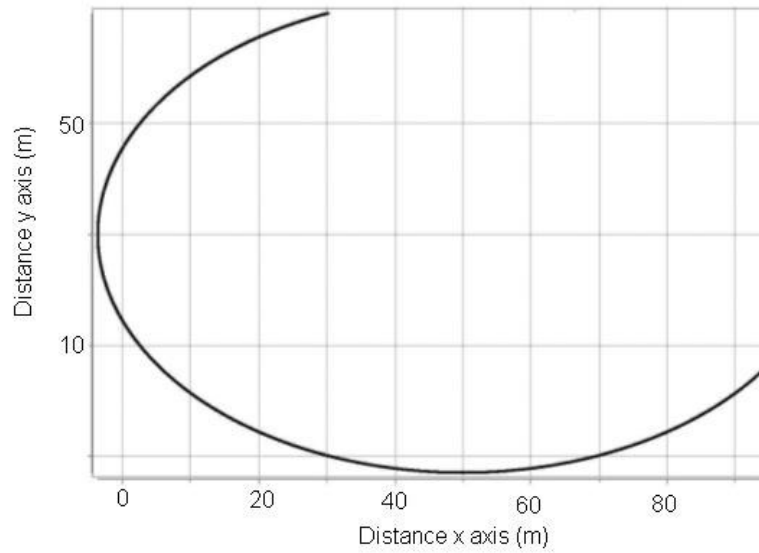

Figure 3-5 Circular Movement

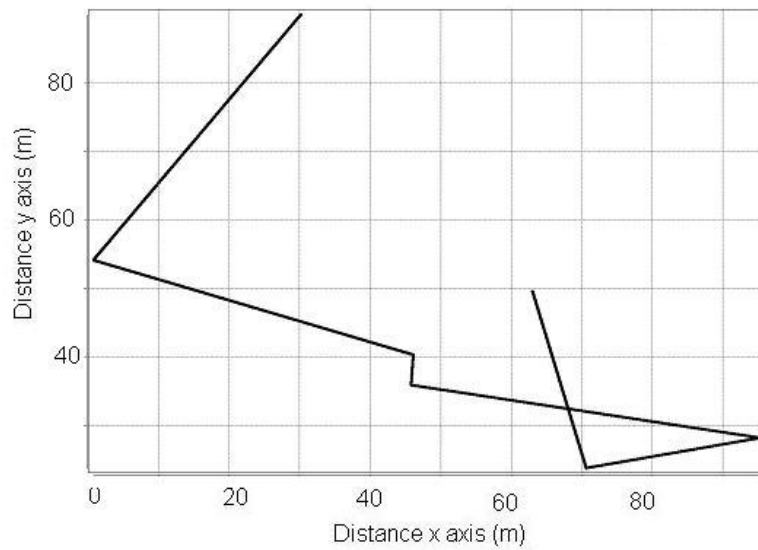

Figure 3-6 Linear Movement

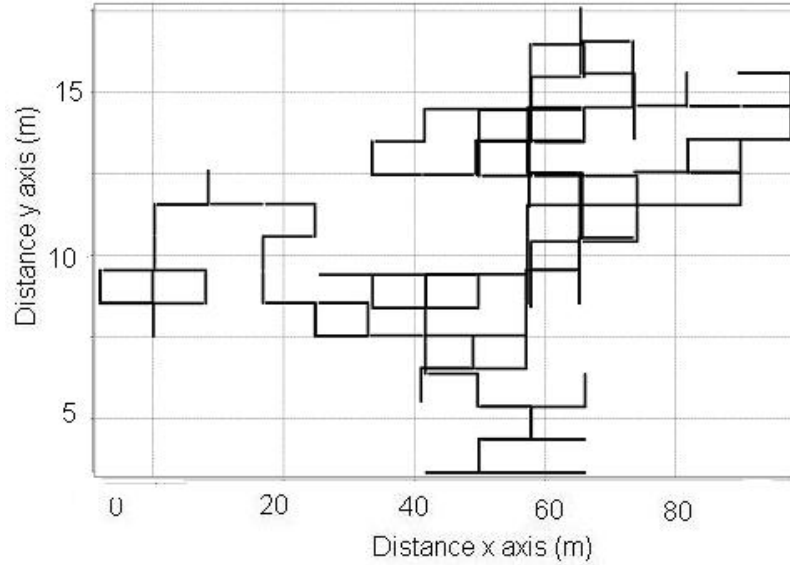

Figure 3-7 Random Movement

As it is seen the in linear movement target follows a linear path and changes its path random. However in random movement the user again travels in a linear path and changes its direction more commonly. In circular movement target moves around a random point circularly. In all graphics it is assumed that user has a constant velocity.

3.6 Intercell Interference Model

Intercell interference is the interference caused by the neighboring cells to the current cell [10]. The value of that interference changes from cell to another cell but can be approximated by a probability distribution function [14]. The path loss between a user and base stations is given below.

$$H_{i,m} = A_p a_{i,m}^{-\nu} 10^{x_{i,m}/10} \quad (3-13)$$

A_p is the antenna gain factor of transmitter antenna and receiver antenna, $a_{i,m}$ is the distance between base station m and mobile station i , ν is the path loss exponent and

$x_{i,m}$ is a zero-mean Gaussian random variable with variance σ_s^2 . The mobile arranges its power due to its current base station and increases it with a factor that is proportional with the path loss between base station. Thus the power transmitted becomes $P.\alpha_m$ (where α is the path loss). So the in the other cell base station receives that power as $P.(\alpha_m/\alpha_o)$. A user submitted to base station B generates interference to the base station A as follows:

$$f_i = p_i \left(\frac{a_m}{a_o}\right)^v 10^{(x_0-x_m)/10} \quad (3-14)$$

The P_i is the average received powers from mobile user i at its current base station. The total interference is the sum of other mobiles:

$$\begin{aligned} & \sum_i p_i \left(\frac{a_m}{a_o}\right)^v 10^{(x_0-x_m)/10} \delta\left(x_0 - x_m, \frac{a_0}{a_m}\right) \\ & \delta\left(x_0 - x_m, \frac{a_0}{a_m}\right) = 1 \quad \text{if } \left(\frac{a_m}{a_o}\right)^v 10^{(x_0-x_m)/10} < 1 \\ & \text{otherwise} \\ & \delta\left(x_0 - x_m, \frac{a_0}{a_m}\right) = 0 \end{aligned} \quad (3-15)$$

It is obvious that if a user is submitted to cell B than the path loss proportion α_m/α_o is less than 1. Otherwise hand-over occurs and user passes to the other cell.

In the simulation intercell interference is modeled as an additive zero-mean Gaussian random variable with standard deviation of 0.8 [32]. The background noise is also a zero mean Gaussian variable with variance $N/2$. The N is calculated with formula:

$$N = k.B_w.T.N_f \quad (3-16)$$

B_w is the bandwidth of the CDMA communication and taken as 5MHz, the k value is Boltzman constant. T is 290 K and the noise figure is 5 dB [5].

3.7 Traffic Model

The main purpose of 3G CDMA systems is satisfying different types of services. However it can be assumed that one user can not use different types of data packets at the same time. For example user sends or receives voice packets but can not send or receives Internet packets at the same time.

Real time traffics (RT), non-real time traffics (NRT), traffics with constant bit rate (CBR), traffics with variable bit rate (VBR) and traffics with available bit rate (ABR) are the different types of services. In our simulation studies, the traffic models in [9] are used.

Voice traffic is the main traffic seen in cellular networks. It is real time traffic with low rate. The BER requirement for voice traffic is smaller. It can tolerate to the BER value of 10^{-2} because human ear can neglect some errors in the communication. However the delay of the packets is important. Long jitters cause a bad quality in the human communication and should be avoided. A voice communication is consists of talk spurts and delays. Those delays are due to listening the other person in the line.

Voice traffic is simulated as two state Markov processes. The “ON” state and the “OFF” state The “ON” state also have two “ON” state and the “OFF” states.

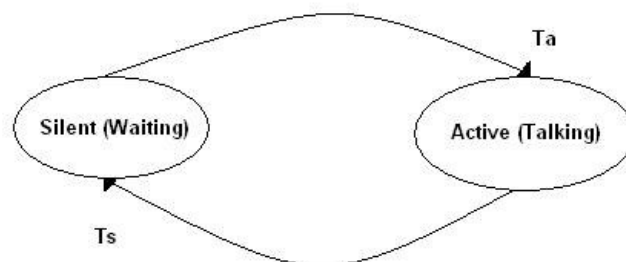

Figure 3-8 Voice Traffic Structure

The length of gaps, and mini-gaps, spurts and the mini spurts are calculated stochastically. Lengths are exponentially distributed and the means are [9]:

Table 3-1 Voice Characteristics

	Mean (ms)
Spurt	1000
Gap	1350
Mini gap	50
Mini spurt	235

The rate of voice traffic is constant and 16.5kb/s. The voice packets are generated as in the below figure (The bit size of the current voice packet is cumulatively added to the previous). There are gaps and mini gaps distributed along communication. If we simulate the number of bits generated we will get the following figure:

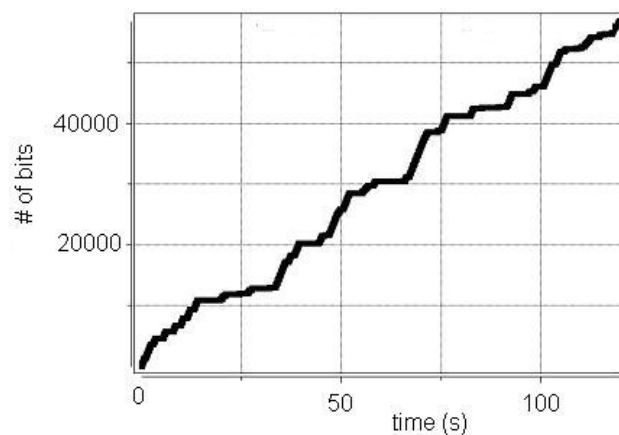

Figure 3-9 Voice Traffic

Real time video traffic has a variable rate factor. The variations are due to today's video compression techniques. The data is generated due to the frame differences. With the frame variable rate coding technique only significant differences between successive frames are coded. A speaking person with only mouth picture changes does not generate big video data. The fast changing frames such as a seen from a moving car generates more data. Due those video compression techniques the data packets comes in bursts as in voice communication. Unlike in voice traffic For RT-VBR service model has more that two stages and at each stage the user waits for a time which is exponentially distributed with a mean of 160ms. The data rate in each stage is constant and calculated from a truncated exponential distribution with between 16 kb/s and 64 kb/s. The mean video transmission time is assumed to be 180.0 s. As in voice traffic the video traffic is also sensitive to delays and jitters and requires more stringent BER.

Video traffic is simulated by N states which have different rates that are distributed by exponential function with mean 480 bits per frame. The probability to change state is distributed also exponentially with mean 160ms. In below figure the packets generated in each iteration are given. The video traffic changes the size of the packets in a frame by changing its state. The size of the video traffic can be seen in **Figure 3-10**.

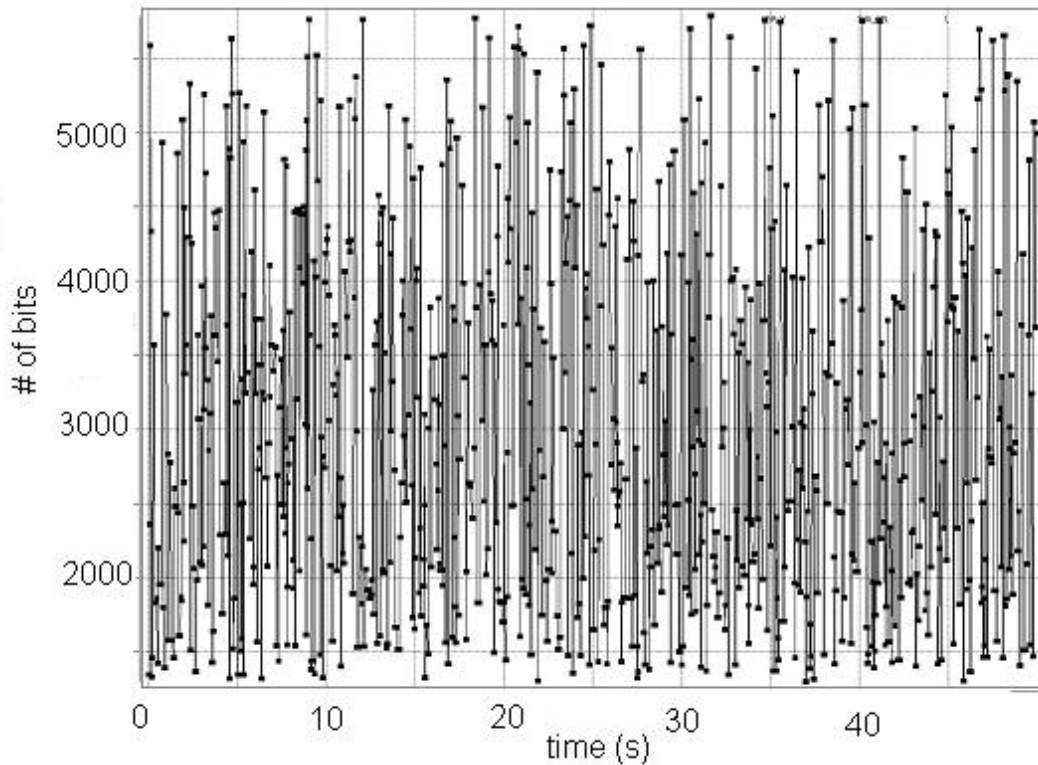

Figure 3-10 Video Traffic

CBR (constant bit rate) audio and video traffics are constant bit rate traffics they are implemented to generate same amount of data at each frame. The CBR audio generator generates 480 bits in a frame and CBR video generates 960 bits in a frame.

Unlike real time services the non-real time services has no delay bound. They are like the data traffic in Internet service. They require less BER than the two services mentioned above because a loss in the data chains makes it harder to resolve the data. Thus delivery time is not important the packets can wait but they should be delivered accurately so they require more resources. The NTR-VBR requires a BER of 10^{-6} and RT-ABR and RT-UBR services requires a BER of 10^{-8} .

The data traffic is bursty. The number of packets in each burst can be approximated with an exponential distribution. Some data services require lesser delays such as remote login. For ABR traffic the data message length is assumed to be

exponentially distributed with a mean size equal to 30 kb. For those traffics the rate or the data is a Poisson process with average equal to 0.2 messages/frame. During the remote login session, the overall length of all messages is exponentially distributed with the mean equal to 30 kb.

We simulate the E-mail traffic as one of the non real time services. It is constructed by the below histogram:

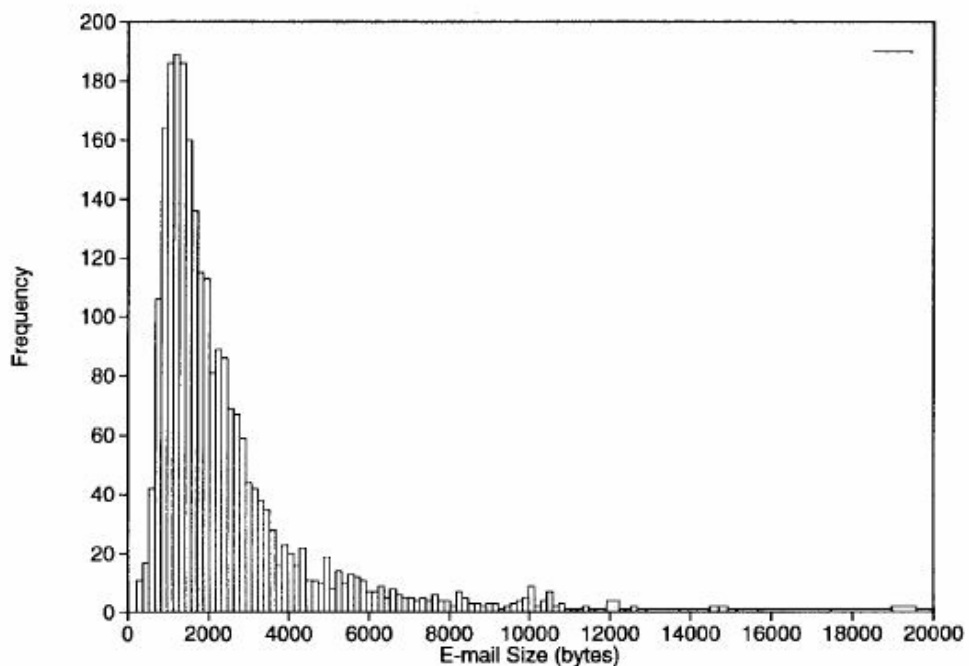

Figure 3-11 Email Histogram [8]

There are 2500 e-mails at the total. The probability distribution function is calculated from that histogram and than the probability density function is found by taking the integral of the distribution function. The inverse of the distribution function is found and fit to 10 degree polynomial which is:

$$size = \sum_i a_i . x^i \tag{3-17}$$

The polynomial constants are as follows:

a[0]=84935706.30725209; a[5]=-206866730.6393144;
a[1]=-394550362.8909398; a[6]=46482373.12810482;
a[2]=774242552.554932; a[7]=-5341236.585809999;
a[3]=-833435805.3705969; a[8]=192380.7615911476;
a[4]=534349127.5653883; a[9]=11991.98467165011;
a[10]=208.435137132051;

After finding polynomial a uniform number x between 0 and 1 is chosen and put into the polynomial and the size of packet is calculated. The statistics shows similarity with above histogram.

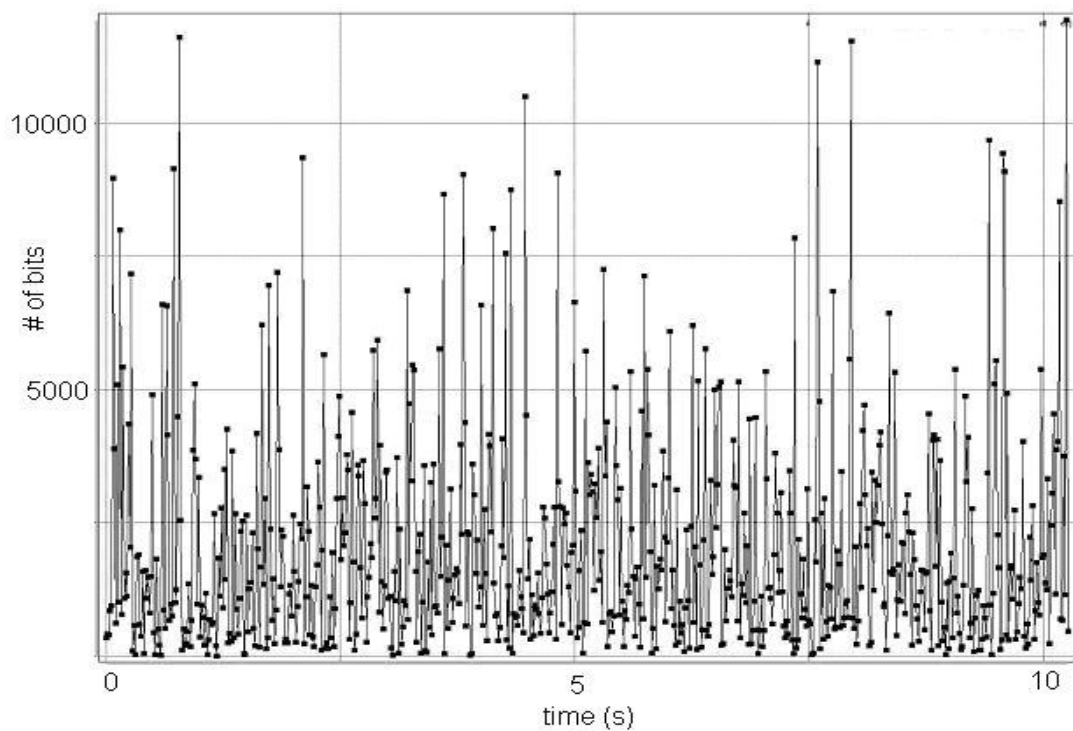

Figure 3-12 Email Probability Distribution

The histogram of above simulation is gives as:

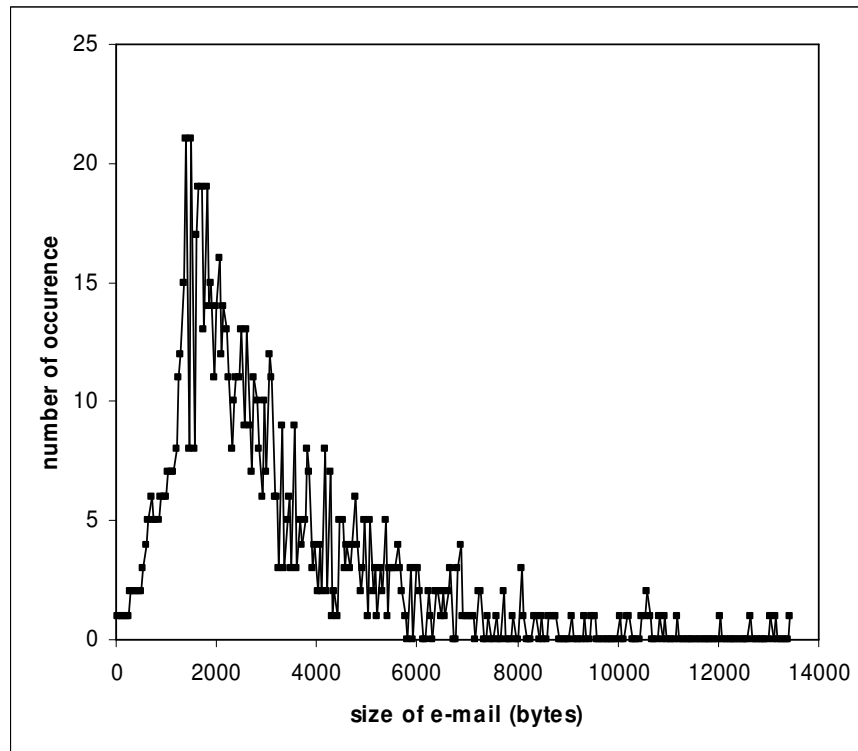

Figure 3-13 Email Histogram Obtained

Login generator is like e-mail generator. A data of exponentially distributed with a mean of 450 bits/frame is generated and send with delay requirement.

The data traffic is simulated with web browsing which a user uploads some data and than read the web page [30], [31]. When reading moment it is assumed that there is no data traffic. The read time is distributed exponentially with a mean of 5s and data size is generated exponentially with a mean of 270 bits/frame.

3.8 Summary of the Parameters

The values of the network parameters and the types of the models that are used in our study are summarized in table below.

Table 3-2 Summary of the Parameters

Parameter/Model	Selected value/type for the study
CDMA Network	Single cell Square shape, 1 side=100m
CDMA Model	Time Slotted Multi-Code 5Mhz Bandwidth 3.86 Mchips/s Frame Length 15ms Number of Time Slots 15
Paths Loss	Path Loss Exponent: 2.7 Antenna Near Field: 1m Shadowing Variance:3.65 Number of Fading Paths:20 Delay Spread: Uniform (15 μ s-20 μ s)
Mobility	Constant Speed 2m/s Linear Movement
Handoff	No Handoff Happens

3.9 Implementation and Performance Evaluation Using Simulation

In this thesis OMNET++ [28] is used for implementation and performance evaluation of the scheduling algorithms.

3.9.1 OMNET Simulation Environment

OMNET++ program is an object-oriented discrete event network simulator program which the programming codes are written in C++. The classes of OMNET++ handle the functions written in C++. The simulator can be used in

- traffic modeling of telecommunication networks
- protocol modeling
- modeling queuing networks [33]

The OMNET++ simulation tool has simple and compound objects which can send messages to each other and also to themselves. Modules communicate through message passing. Messages can contain embedded parameters and arbitrarily complex data structures. Modules can send messages either directly to their destination or along a predefined path, through gates and connections. When those messages are received the target object does the job that it is programmed for that kind of message. The simulation tool has some important random number generators such as exponential and Gaussian. OMNET++ has object models that are hierarchically nested.

In the following figure, a CDMA network with one base station and 600 mobile stations is given as an example:



Figure 3-14 CDMA Cell

We use the following model with three channels for the uplink case of the CDMA cell simulation. Two of the channels are information channels which mobile stations send their traffic information, the packet sizes, types and due times and base station sends the scheduling information about how many packets will be served and the power of the mobile station. The third channel is data channel which mobile stations send their packets to base station and base station forwards into the central switching unit. The mobile station is designed as in figure below.

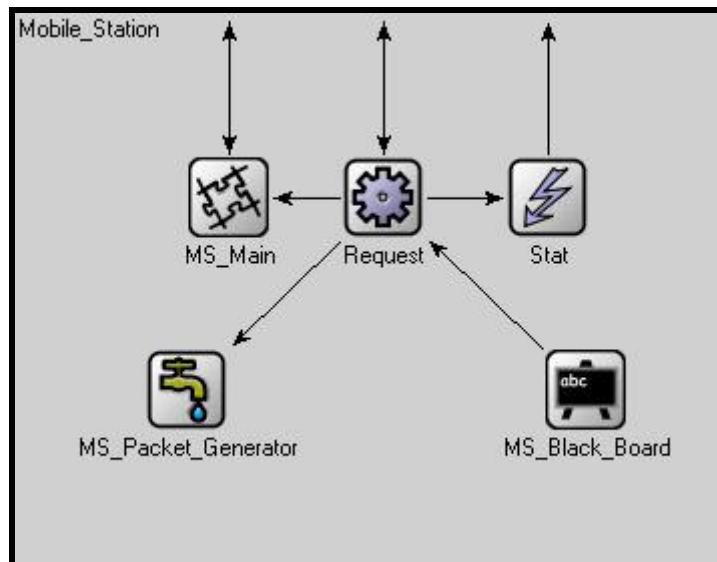

Figure 3-15 Mobile Station

Each mobile station has a blackboard which stores its parameters. The output buffer is located in the blackboard and the generated messages are put in that buffer. The expiration control of the packets is done here and they are dropped if the due time is reached. Also the mobility parameters are calculated here. Depending on the type of mobility the distance from base station is calculated in each frame.

The black board also keeps track of transmission requests. The requests are done by Bernoulli trials. The request block sends and receives request from base station and starts or stops data and statistics generation.

The *Stat* block sends the distance information packet size, packet type information. The distance information is used to calculate path loss. In a real system the path loss is calculated by pilot signal. This information is sent in information channel and updated in every frame.

The base station is designed as in **Figure 3-16**. *BS_Main* block controls the packets that will be sent to base station. It collects the information data from base station and arranges number of packets due to that information and sends to the base station.

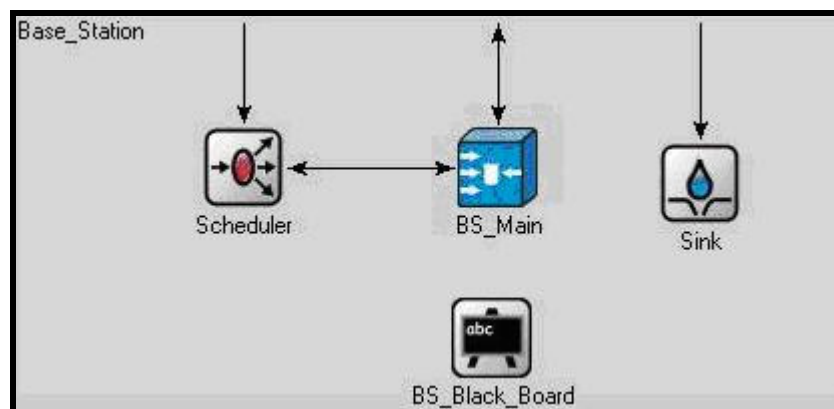

Figure 3-16 Base Station

The Base station also has a black board which keeps track of its parameters. The black board also has the packet, user and slot lists and updates them in each frame. One duty of the blackboard is calculating priorities and finding number of packets for users to be sent for each frame. Also it calculates the path loss from the distance information of the mobiles.

The *Sink* object gets the data packets and collects results: Average throughput, average delay and number of packet drops. The average throughput is calculated according to a confidence interval. In **Figure 3-17** it is seen that the system reaches steady state after 100s which is equal to 800 frames.

The *BS_Main* block sends scheduling information to the mobiles and coordinates the requests from mobile users. The scheduler object includes the scheduling algorithm. It gets information statistics from mobiles and decides which users send how many packets.

3.9.2 Confidence Interval

The simulation results are taken by increasing the number active loads. In each certain number of mobile stations the simulation is run for a number of frames. The decision of the number of frames is important for collecting results similar as in the real case. In the beginning of simulation time the results taken can give wrong results but they come to a steady state after some iteration. As in **Figure 3-17** the early results taken do not reflect the steady state.

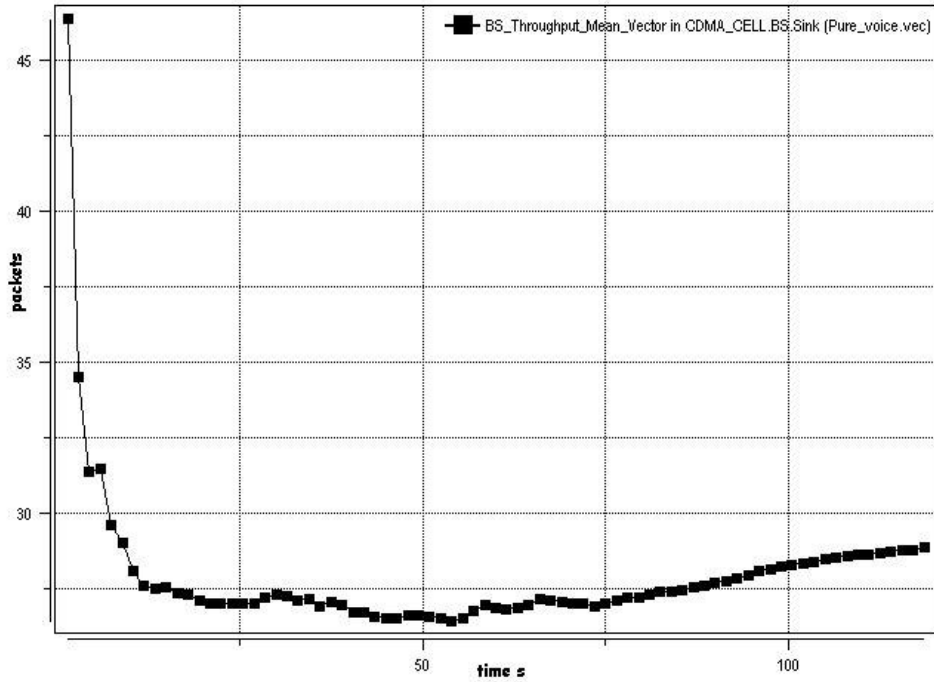

Figure 3-17 A Simulation Run

The ideal solution is iterating very long; however to optimize the simulation time the iteration number should be calculated. In [34] for the solution of that problem *confident stopping rule* is described. It gives the confidence time or the iteration number that gives the mean of a simulation result with certain probability to be in certain percentage of the mean of the real result. In the simulation I chose to be in %5 neighborhood of the real mean with %99 percent probability. With those parameters the iteration number is calculated as:

$$N = \frac{4 \cdot t_{99\%}^2 \cdot s_n}{\Delta^2 y_n^2} \quad (3-18)$$

$t_{99\%}$ is 2.98 for %99 probability and Δ is 0.05 [34]. The s_n stands for the standard deviation and y_n stands for mean of the result that is being collected. In the simulation the results are updated in each 100 frame. During 100 frames the results collected are averaged.

CHAPTER 4

SCHEDULERS FOR CDMA NETWORKS

Scheduler is the main unit of the network access layer. It controls the traffic flow from multiple users. In wireless networks several users have to share the same physical channel and access to the medium must accordingly be coordinated. In cellular systems that access control mechanism is placed at the base station (BS).

The base station dynamically allocates the total capacity to the users in the form of time slots, while keeping track of the priority of the users whose connections with high QoS requirements are given higher priority. To overcome that allocation problem in the base station there exists a sequence controller thus a scheduler in the base station (**Figure 4-1**).

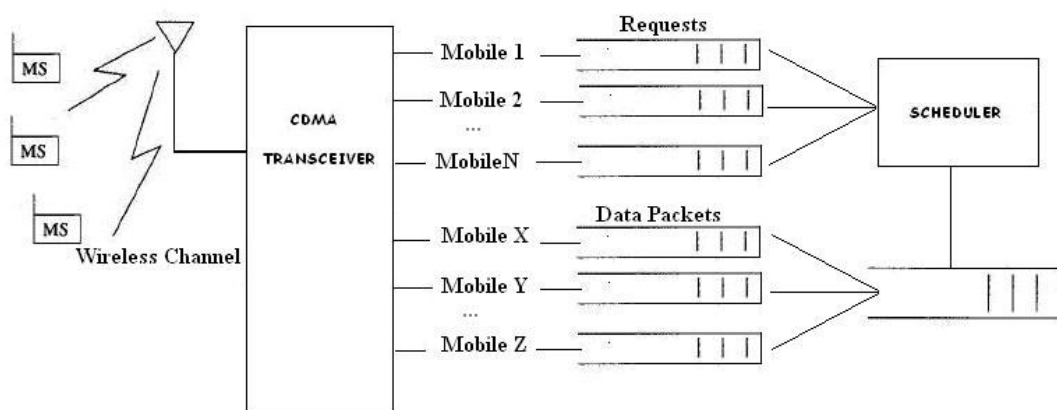

Figure 4-1 Scheduler in the Base Station

Schedulers can be classified as work conserving and non-work conserving. Work conserving schedulers never go to idle state if there is a packet waiting for transmission. However non-work conserving schedulers may be idle even if there is backlogged packet in the system. Because there can be another higher priority packet to arrive. Those schedulers have higher delays because of waiting to collect all the packets to arrive in a given interval of time.

Today the demand to multimedia applications in wireless area is increasing. In 3G cellular systems it is aimed to handle different traffic types. This means it has to satisfy different kinds of QoS requirements. Real time traffic (RT), non-real time traffic (NRT), constant bit rate traffic (CBR), variable bit rate traffic (VBR), traffic that utilizes the available bit rate (ABR) and traffics with unspecified bit rate (UBR) have different QoS metrics. Those applications demand different loss rates, delays, jitters and throughput. These requirements are given in the table below [22].

Table 4-1 QoS Properties

		Bit Rate (bps)	Delay Tolerance (ms)	BER Requirement
RT-CBR	Voice	32K	30-60	10^{-2}
RT-VBR	Video Conference	128K-6M	40-90	10^{-3}
NRT-VBR	Video	1M-10M	Large	10^{-6}
NRT-ABR	File Transfer	1M-10M	Large	10^{-8}
NRT-UBR	Web Browsing	1M-10M	Large	10^{-8}

The main duty of the scheduler is allocating the capacity of the system to the users. However the capacity metric in wireless communication changes, also the states of the users changes in time that varies the path loss and interference. Due to that at each time frame scheduler should collect new data from the channel and used to decide which user will transmit with what rate and power. That data includes the number of users accessed (it is important for interference in CDMA network) and their traffic properties to resolve QoS parameters given in the above table and the path loss of the users.

4.1 Maximizing the Soft Capacity with Scheduling

The problem in CDMA communications is the allocation of rate, power, and the transmission time to the users. Schedulers adjust these parameters and assigns code slots to the users to increase the number of bits sent in a frame.

$$\text{maximize} \left\{ \sum_{s=1}^S M_s \right\} \quad (4-1)$$

M_s is the bit size of a packet in a code slot s as seen in below figure.

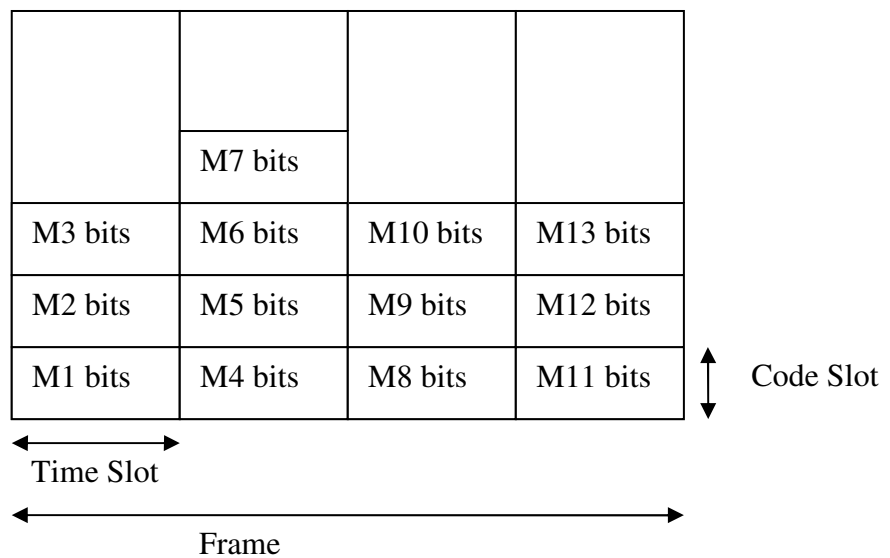

In CDMA communication the other users act like interferers to the users. Interference caused by the users communicating in the same cell is called intracell interference. In non-orthogonal systems in which the signals from two different users are correlated, such as CDMA intracell interference is the limiting factor of the system capacity. However in orthogonal multiplexing techniques such as FDMA and TDMA intracell interference is raised from multipath, synchronization errors, and other practical impairments that compromise the orthogonality which is much more less than in non-orthogonal case.

That factor limits the number of users communicating at the same time. While maximizing the number of bits granted in a frame time it must be assured that SNR level of the users are above some limit to decrease the communication errors thus bit error rate (BER). The SNR formulation is written in CDMA as (4-2) [13].

$$SNR = \frac{(W/R)P\alpha}{I + N_0} \quad (4-2)$$

I corresponds to the interference from other users, N_0 is the white noise and P corresponds to the power of the user and α is the path loss. W is the chip rate of CDMA which is constant and R is the rate of user data. We adopt the following formulation in [9] in our study. The above formula can be expanded as (4-3)

$$\lambda_n = \frac{S_n}{\frac{I_{intra} + I_{inter}}{1.5G_n} + \frac{N_0B}{G_n}} \quad (4-3)$$

λ_n is the minimum SNR value to satisfy the BER requirement of the packet. S_n is the received power of user n where I_{intra} is the intra-cell interference (the interference caused by the mobile stations present in the same cell) and I_{inter} is the intercell interference (the interference caused by the mobile stations present in other cells). N_0B is the background noise and G is the spreading gain (W/R). 1.5 arises because the thermal noise is assumed to be Gaussian and rectangular pulses are used in the code waves [15].

Intra cell interference encountered by the user j can be written as (4-4).

$$I_{int ra} = \sum_{n=1}^N m_n S_n - m_j S_j \quad (4-4)$$

The received powers by the users $n=1 \dots N$ are taken as intra cell interference by user j . The number of code channels m used by the same users in a time slot may be greater than 1 as we assumed multi code case for CDMA. In multi code CDMA the packets are sent with different codes in parallel.

If we combine the above two equations for user j we will get:

$$\lambda_j = \frac{S_j}{\frac{\sum_{n=1}^N m_n S_n - m_j S_j + I_{inter}}{1.5G_j} + \frac{N_0 B}{G_j}}$$

so :

$$\frac{\sum_{n=1}^N m_n S_n - m_j S_j + I_{inter}}{1.5} + N_0 B = \frac{S_j G_j}{\lambda_j}$$

so :

$$\sum_{n=1}^N m_n S_n - m_j S_j + I_{inter} + 1.5N_0 B = \frac{1.5S_j G_j}{\lambda_j} \quad (4-5)$$

so :

$$\sum_{n=1}^N m_n S_n - \left(m_j + \frac{1.5G_j}{\lambda_j} \right) S_j = -(I_{inter} + 1.5N_0 B)$$

Now assume in the same slot user i is also communicating at the same time slot with user j . So a similar formulation for that user can be derived.

$$\sum_{n=1}^N m_n S_n - \left(m_i + \frac{1.5G_i}{\lambda_i} \right) S_i = -(I_{inter} + 1.5N_0 B) \quad (4-6)$$

As it can be seen both right sides of the equations are same. So we can equate them.

$$\sum_{n=1}^N m_n S_n - \left(m_i + \frac{1.5G_i}{\lambda_i} \right) S_i = \sum_{n=1}^N m_n S_n - \left(m_j + \frac{1.5G_j}{\lambda_j} \right) S_j$$

so :

$$\left(m_i + \frac{1.5G_i}{\lambda_i} \right) S_i = \left(m_j + \frac{1.5G_j}{\lambda_j} \right) S_j \quad (4-7)$$

so :

$$S_i = \frac{\left(m_j + \frac{1.5G_j}{\lambda_j} \right)}{\left(m_i + \frac{1.5G_i}{\lambda_i} \right)} S_j$$

As it can be seen there exists a ratio of given in equation above between the users communicating at the same time. We can reconfigure the SNR equation with above formula and find the received power S_j . Further it will be assumed that there is an upper limit for the received power, because the transmitter of the mobile stations has limited power P^{max} . The path loss is again contributed as α variable.

$$\sum_{n=1}^N m_n S_n - \left(m_j + \frac{1.5G_j}{\lambda_j} \right) S_j = -(I_{inter} + 1.5N_0B)$$

so :

$$\sum_{n=1}^N m_n S_j \left(\frac{\left(m_j + \frac{1.5G_j}{\lambda_j} \right)}{\left(m_n + \frac{1.5G_n}{\lambda_n} \right)} \right) - \left(m_j + \frac{1.5G_j}{\lambda_j} \right) S_j = -(I_{inter} + 1.5N_0B)$$

so :

$$S_j \left(m_j + \frac{1.5G_j}{\lambda_j} \right) \left(\sum_{n=1}^N \frac{m_n}{m_n + \frac{1.5G_n}{\lambda_n}} - 1 \right) = -(I_{inter} + 1.5N_0B)$$

so :

$$S_j = \frac{(I_{inter} + 1.5N_0B)}{\left(m_j + \frac{1.5G_j}{\lambda_j} \right) \left(1 - \sum_{n=1}^N \frac{m_n}{m_n + \frac{1.5G_n}{\lambda_n}} \right)} \leq P^{max} \alpha_j \quad (4-8)$$

The above formula is helpful for checking the users communicating at the same time if they violate the communication of the others. By adjusting the above formula we can find limit for the total powers of the users communicating at the same time.

$$\sum_{n=1}^N \frac{m_n}{m_n + \frac{1.5G_n}{\lambda_n}} \leq 1 - \frac{\alpha_j (I_{inter} + 1.5N_0B)}{P^{\max} \left(m_j + \frac{1.5G_j}{\lambda_j} \right)} \quad (4-9)$$

The above equation will be checked for all the users $j=1 \dots N$ communicating at the same time. Therefore each user will satisfy that inequality. It will be wise to check the left hand side of the equation with the smallest value of the right hand side of the equation. So:

$$\sum_{n=1}^N \frac{m_n}{m_n + \frac{1.5G_n}{\lambda_n}} \leq 1 - \max\{\Delta_j\}_{j=1 \dots N}$$

where (4-10)

$$\Delta_j = \frac{(I_{inter} + 1.5N_0B)}{S_j \left(m_j + \frac{1.5G_j}{\lambda_j} \right)}$$

This is used as the capacity of the slot. The capacity is a soft capacity that is changed by the users put into the slot

So there are several parameters that can be adjusted to solve the maximization problem for the schedulers.

- Increasing the transmitted power P_j for a user j :
 - Increases the SNR of the user. That causes better reception.
 - Causes greater interference to the other users.
- Lowering the spreading gain G_j for a user j :
 - Increases the SNR of the user. That causes better reception.

- Decreases the number of bits transferred in a frame for user j .
- Assigning more multi code slots m_j to the same user j .
 - Increases the number of bits transferred in a frame for user j .
 - Causes greater interference to the other users.

The limits for the above parameters are known the scheduler tries to maximize the number of bits transferred in a frame, however it should not go over the capacity of the channel in given (4-10). If the capacity is used over the limit, the quality of communication decreases.

When designing a scheduler or comparing schedulers, certain other metrics are also taken into account:

- Fairness: The resources should be fairly distributed among the users.
- Delay guarantee: The delay bound requirements for the users should be satisfied. The delay in a network consists of transmission and propagation delays that are due to physical properties of the channel and queuing, processing delays that are caused by the scheduler.
- Throughput: The algorithm should maximize the number of users communicating at a time.
- Implementation complexity: The algorithm should decide fast enough. This is critical for high speed networks. In CDMA network the decision time should not exceed one frame time.
- Scalability: As the number of users communicating increases the algorithm performance should not decrease.
- Energy consumption of the mobile station: The algorithm should not decrease the battery life of the mobile station.

- **Efficient Link Utilization:** The algorithm should keep track of users who go in a lossier channel state, to increase the utilization that users should not allow to communicate when they are in that state.

4.2 Schedulers Proposed In Literature for CDMA

In the literature several scheduler algorithms are proposed including *wireless multimedia access control protocol with BER scheduling* (WISPER) [8], *minimum-power allocation and rate- and BER-scheduling* [9] (we call this algorithm MPARS), *dynamic resource scheduling* (DRS) [5] and [6], *generalized processor sharing* (GPS) [2] and [3], *scheduled CDMA* (SCDMA) [4], *fair packet loss scheduler* (FPLS) [11]. Addition to schedulers some mathematical approaches are also used to solve scheduling problem those are genetics algorithms [20] and game theory [14].

The BER scheduling algorithms aim to increase the channel capacity by scheduling packets with similar BER requirements together. The WISPER algorithm is one of the very first BER scheduling algorithms and is referred to by many following work in the field. WISPER algorithm follows a heuristic approach, MPARS algorithm formulates the BER scheduling as a linear programming problem, then proposes heuristic approach based on this formulation.

The variable gain schedulers bring a new idea of changing the spreading gain. Variable spreading gain systems offer bandwidth on demand, by employing a variable spreading gain for variable rate users. The spreading gain G value is not fixed in those schedulers. *Dynamic spreading gain control* [36] algorithm is one of those schedulers. It adjusts the spreading gain of the non-real time services to maximize the utilization for non-real time services. The variation of the spreading gain idea is applied to other services in *Dynamic resource scheduling* (DRS) [5] algorithm. The spreading gain changes with the type of the services and is computed by assuming different rates to the different service types. Maximum symbol rate is assumed for variable bit rate (VBR) traffic, average symbol rate is

assumed for constant bit rate (CBR) traffic and minimum symbol rate for available bit rate (ABR) traffic. In DRS the multi-code operation is not used that is to say the $m_{k,n}$ value found in equation (3-5) is 1. The multi code operation is investigated in MC-DRS algorithm [36].

The variation of the spreading gain brings more computation complexity of the scheduler. There are more parameters to consider such as power, the number and the type of the services allowed at the same time slot, and the gain of the flow. Some algorithms assume that gain is fixed to solve the optimization problem. In [5] and [6] the gain is varied between service types however the flows with same service type have the same gain. Those algorithms do not consider the time slotted model.

Generalized processor sharing (GPS) [2] and [3] *scheduled CDMA (SCDMA)* [4], *fair packet loss scheduler (FPLS)* [11]. Addition to schedulers some mathematical approaches are also used to solve scheduling problem such as genetic algorithms [20] and game theory [14].

Generalized processor sharing (GPS) [2] scheduler is a work conserving uplink scheduler which computes user rate and powers by arranging the flow of packets according to their delay guarantees while meeting BER requirements. The simulations show that GPS satisfies the fairness between users and guarantees a delay bound for the traffic. It assumes a time slotted CDMA model.

Fair packet loss scheduler (FPLS) [11] focuses on uplink transmission and assumes time slotted CDMA. It uses the fact that the packets that wait in the queue so long so they have exceeded their delay bound, will be dropped. The algorithm tries to equalize the dropping ration of the users.

SCDMA scheduler is a work conserving scheduler which serves the users according to their delay bounds and calculates the rate and the power of the users that will communicate in a time slot. Firstly how many users can communicate at the same time is found and than the powers of the users that are allowed to communicate at the same time is calculated.

Game theory approach has been used to study power control which is modeled as a non-cooperative game in which users choose their transmit powers in order to maximize their utilities, where utility is defined as the ratio of throughput to transmit power.

We implement and evaluate WISPER [8] and MPARS [9] in the following section. WISPER is one of the first algorithms for slotted CDMA systems which serve as a reference to majority of the following work in the field. MPARS have more detailed channel models that gives helpful insight for designing a simulation.

CHAPTER 5

EVALUATION OF SELECTED PACKET SCHEDULING ALGORITHMS: WISPER AND MPARS

We implement and evaluate Wireless Multimedia Access Control Protocol with BER Scheduling (WISPER) [8] and Multimedia Access Control with Minimum-Power Allocation and Rate- and BER-Scheduling [9]. We call the algorithm in [9] in this thesis as MPARS. These algorithms are designed for the uplink scheduling and can be applied for the downlink at the same time. In the uplink transmission the main duty of the scheduler is deciding which user will be allowed to send packet in the next frame, finding the number of packets of allowed users that will be served in the next frame and placing those packets to the time slots in a frame.

5.1 Operation

The aim of the both schedulers is maximizing the number of bits sent in a frame when satisfying the SNR requirement and the delay bound of the users. The slot accommodation is optimized to increase the number of bits supported in each frame.

The first step of the both WISPER algorithm and MPARS is collecting requests and finding which users will be served in the next frame. The decision is made according to the number of the packets of the users that will be served and the expiration times of them. The required information about the packet type of the user

and the message size of the user is collected by a control channel that exists in CDMA.

The expiration time means that a packet will be served within a specific time period to satisfy the delay guarantee of that traffic type. Real time traffics are sensitive to delays. If the expiration time is reached the packets are dropped because they are useless. Some traffic can overcome that packet losses such as voice traffic but data traffics can not tolerate that losses.

In order to satisfy that QoS the scheduler assigns priority to the users and begins serving them according to that priorities. The priority formula for each flow in WISPER algorithm is as follows:

$$\Phi_{\beta}(t) = \min\left(\frac{\lceil P_{\beta}(t) / M_n \rceil}{F_{\beta}(t)}, N_p\right) \quad (5-1)$$

$P_{\beta}(t)$ is the number of packets left of the user β and M_n represents the maximum number of the packets that can be transmitted simultaneously in a time slot and $F_{\beta}(t)$ is the number of frames left. N_p is the maximum number of code slots in a time slot. The priority formula for algorithm in [9] also contains the deadline and message size parameters:

$$\Phi_{\beta}(t) = \frac{K_{\beta}(t)}{T_{\beta}^{due} - T_{\beta}^{current} + T^{frame\ time}} \quad (5-2)$$

K_{β} is the number of remaining packets and T_{β}^{due} , $T_{\beta}^{current}$, $T^{frame\ time}$ are due time, current time and frame time consecutively.

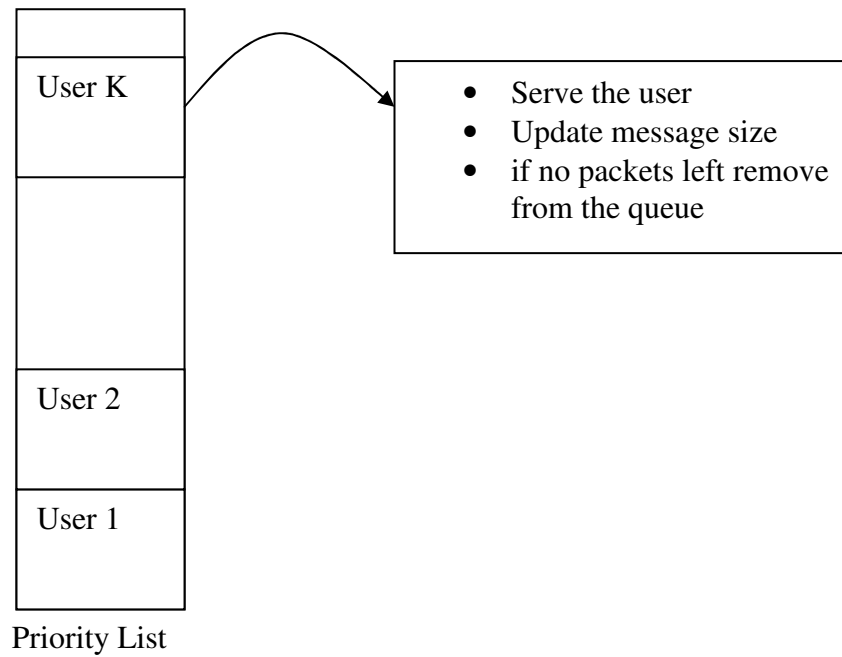

Figure 5-1 Priority List

After collecting the information for the users will be served in the next frame, the numbers of packets that will be allowed from those are calculated by the scheduler. For WISPER the packets of a user are divided equally into frames. The numbers of frames are calculated from the expiration time of that packet. For example the delay requirement of traffic is 2 frames and there are 4 packets for that user, 2 of the packets are sent in one frame and the other 2 are sent in the following frame. The formula is as follows:

$$N_{\beta}(t) = \min(\lceil \Phi_{\beta}(t) \rceil | M_n, P_{\beta}(t)) \quad (5-3)$$

WISPER divides packets equally into frames until it expires. However MPARS algorithm the packets of the same user are not divided. It tries to put all of the remaining messages of the same user in the same time slot. The idea in MPARS gives better results because it improves the utility due to trying to send all the remaining packets of the same user in the same frame. This idea decreases the number of different users in a frame to decrease the interference.

Those two steps, finding priorities and finding number of packets to serve, are repeated for the following frame and updated in each frame. After deciding on the users and computing the number of packets the scheduler places the packets in the time slots. The WISPER algorithm makes a heuristic approach to the allocation problem. The idea is trying to put the users with same BER requirements into the same time slot. The main aim of that scheduler is maximizing the throughput with efficient use of available bandwidth. In CDMA the simultaneous users cause interference to each other and that limits the number of simultaneous users. The number of users in a time slot is limited due to the more stringent BER requirement of the packet in that time slot (4-10). Grouping packets with similar BER requirements and sending them in same time slot increases the throughput of the system. The allocation criterion of the WISPER scheduler is as follows:

- 1) Accommodation in empty slots or in slots that have packets with the same traffic class.
- 2) Accommodation in slots that have packets with more stringent BER requirements.
- 3) Accommodation in slots that have packets with more relaxed BER requirements.

The scheduler searches the whole frame for empty slots starting from first slot to the last time slot. If an empty slot is found the packet is accommodated to that slot. If no empty slots are found in the frame, the scheduler starts searching for the slots that contain the flows with the same traffic class (so with same BER requirement) with the service type of the packet that we want to accommodate. If a slot is found the packet is accommodated to that slot. If no such slots are found, the scheduler searches for a time slot that contains a packet with more stringent BER requirement in the frame. If an empty slot is found the packet is accommodated to that slot. Also if there is no slot is found the worst case is solved by putting packets with more relaxed BER requirements. In WISPER the system parameter of different types are found and given in the table:

Table 5-1 Parameters of WISPER

Service Type	Maximum Number of Packets per Slot S	Maximum Transmission Rate Capability
Video Traffic	15	1
CBR Audio Traffic	10	6
CBR Video Traffic	8	4
VBR Video Traffic	6	5
Computer Data Traffic	4	4
E-Mail Traffic	4	1

The maximum number of packets corresponds to the number of simultaneous transmissions allowed for that traffic in a time slot and the maximum rate capability is the number of simultaneous packets from same user in a time slot. The CDMA multi code operation is considered in WISPER. The multi code allows single users to transmit simultaneous packets with different spreading codes. The rate of a one code slot is fixed by fixed spreading gain of 16 in WISPER scheduler. However the rate of a user can be increased by sending simultaneous packets in a time slot.

For example voice packets allows up to 15 simultaneous packets in a time slot however one user can not send more than one packets in the same time slot. However a video user can send 5 packets at the same time but it allows 6 simultaneous users:

Voice User 15	Voice User 16
.	Video User 5
.	Video User 4
.	Video User 3
Voice User 2	Video User 2
Voice User 1	Video User 1

Figure 5-2 Slot Accommodation in WISPER

After allocation procedure if there is packet left it is again put in the priority queue with remaining packets and if the expiration time is reached it is dropped from the buffer.

The MPARS algorithm solves the optimized slot allocation problem by linear programming method to maximize the uplink capacity. The solution minimizes number of different users in the same time slot. MPARS then proposes a heuristic approach to achieve this maximum capacity. The same idea is used in the WISPER algorithm entirely with a heuristic approach.

The MPARS algorithm first searches for the time slot which is empty or the time slot with same BER requirement of the packet. If such slots are found the algorithm chooses the slots with less capacity than the packets it have. If no such slots are found, than algorithm chooses the one with lesser capacity. If all the slots contain

some packets of different classes the scheduler. It again chooses the time slot with lesser capacity.

In each time slot the BER requirements of the users should be satisfied. The BER is directly related to the SNR level of the signal. The coding and modulation schemes may improve the BER requirement with less SNR. The relation between users in the same time slot is give as:

$$\sum_{k=1}^K \sum_{n=1}^{N_k} \frac{m_{k,n}}{m_{k,n} + \rho_k} \leq 1 - \Delta \quad (5-4)$$

$m_{k,n}$ is the number of code slots used by user n of service type k and ρ_k is $1.5G/\lambda$ and the Δ is given in equation (4-10) can be modified as:

$$\Delta = \max\left(\frac{\alpha_{k,n}(1.5N_o B + I_{inter})}{P_k^{max}(m_{k,n} + \rho_k)}\right) \quad (5-5)$$

P_k^{max} is the maximum transmitted power level of a code channel k . In each iteration, one packet is taken from the priority queue and put in the slot by the slot allocation scheme. When the scheduler places a packet in a slot, the inequality in (5-4) is checked and if it is satisfied the packet is put in the slot and the slot capacity and slot Δ is updated. This is done until the slot capacity reaches $1 - \Delta$. The available code channels in a time slot for a flow are determined according to the minimum-power allocation algorithm. Minimum-power allocation algorithm gives the minimum required power to achieve required SNR value. After scheduling is completed, the received power level of each code channel is computed.

5.2 Implementation in OMNET++

We implement WISPER and MPARS in our OMNET++ simulation environment. To verify the correctness of our simulation model, we first simulate these algorithms with the same simulation parameters that are used in the published work. The traffic models are taken from these papers. It is assumed that network has only video users. In [9] there is no information given on the mobility of the users. That

means during simulation time the path loss from a user is same. That effects the Δ calculation due to that factor the users are assumed to be stationary. To make the same assumptions the intercell interference is also assumed constant. As a result of using the assumptions and models in [8] and [9] the similarity of the two graphs gives the correction of the OMNET simulation. We observe that similar results are obtained in the simulator (**Figure 5-3**). The average percentage difference between the data points of both simulations corresponds to error which is %7 percentage. (The difference between the points of 75,125,175,225 and 275 are taken for both algorithms and normalized with the number of data points)

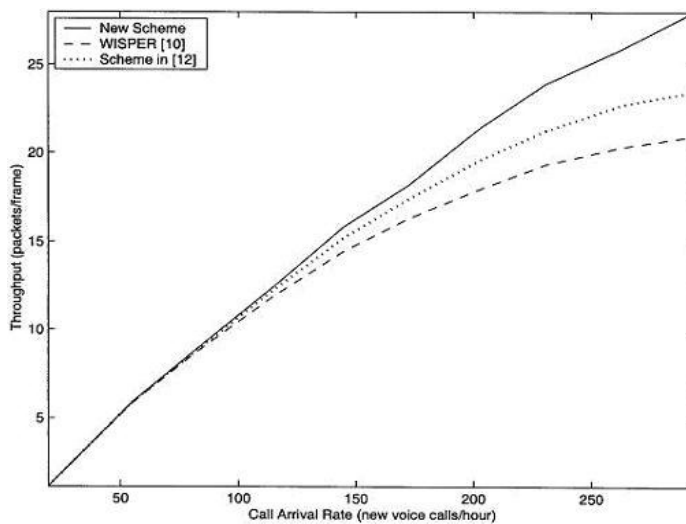

a)Throughput Graph
Taken From [9]

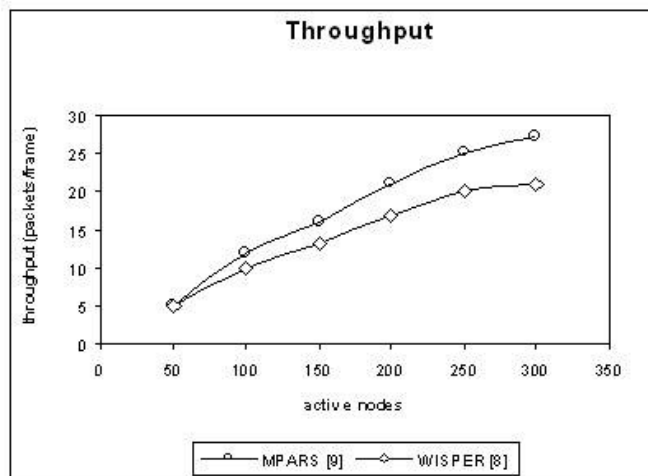

b)Throughput Graph
Taken from OMNET
simulation

Figure 5-3 Throughput Comparison

5.3 Critics

It is seen that the calculation method of both priorities in WISPER and MPARS brings unfairness among users. Firstly the searching of priority list should be done by round robin algorithm. Searching with a rule brings unfairness to the users with equal priorities. The users with same priorities should be chosen randomly to increase fairness in long term. Also the priority formula causes unfairness between traffic types. For example video users generate more packets in a frame than voice users. Due to that factor the video users gains more priority because if the number of packets increases for a flow that increases the priority of the flow. In long term the increase of the video users cause service degradation for voice users. The graph in the **Figure 6-8** shows that unfairness between video and voice users.

In both WISPER and MPARS, grouping users according to BER requirements uses bandwidth efficiently and increases throughput. However fixing the gain and so fixing the packet length decreases the efficiency. Some data messages are shorter than a packet length. As the system gives minimum one code slot to them, the code slot is not efficiently filled. The spreading gain should be changed dynamically to overcome that problem. For example assume a time slot initially contains one voice user. If we fill that time slot with voice users with the parameters given in [8] 15 voice users can be granted service, however if a video user is put in that slot then in additional 5 voice users can be put in that time slot. So putting the voice users into the time slot that has a video user decreases the number of the voice users granted therefore decreases the number of bits served in that time slot. It will be more efficient to send the same services at the same time slot.

Voice User 15	Voice User 6
.	
.	Voice User 3
.	Voice User 2
.	Voice User 1
Voice User 2	Voice User 1
Voice User 1	Video User 1

Figure 5-4 Problem Illustration

That problem is illustrated with the example in 6.3 Utilization Improvement section. In the following chapter that idea will be used with the principles of BER scheduling algorithms. It was aimed to increase the utilization while guarantying the delay requirement for services.

CHAPTER 6

NEW ADAPTIVE CDMA UPLINK RESOURCE SCHEDULER WITH QOS SUPPORT

In this thesis, an adaptive frame based uplink resource scheduler is proposed which performs time scheduling and selects the users to transmit in a frame, dynamically adjusting the rate and the power of the user. The proposed scheduler supports QoS for traffic with CBR (constant bit rate), VBR (variable bit rate) real time and non-real time traffics. QoS support for different traffic classes is achieved without decreased throughput compared to WISPER and MPARS, while limiting the number of packet drops. The implementation and tests of the proposed scheduler is performed with the same parameters that are used in the evaluation of WISPER and MPARS.

The first aim of our scheduler is providing QoS to the *guaranteed* flows. In today's Internet communication a guaranteed service scheme is defined. The users such as companies require a certain bandwidth to be used at any time. It is also becoming an important service in 3G communication. While supporting that service, the proposed scheduler maintains the number of bits sent in the uplink in each frame. The scheduler treats the flows in three different classes. Those are real time (RT), non-real time (NRT) and guaranteed (G) classes. The scheduler aims to be fair among the users of the same class. Our scheduler satisfies the SNR requirement and delay bound of the services when attempting to achieve the above goals.

We consider TD-CDMA uplink for the wireless communication scheme. In CDMA there are several channels for data packet and information packet transfer. It is assumed that the request messages and the information about mobile station status are given to the base station by control channel. Base station collects the necessary statistical information from mobile stations at the beginning of each frame. This information consists of mobile id, size of the packet that will be transmitted, the generation time of the packet, the due time (time that packet will become useless and drop) of the packet, the output power of the mobile station and the path loss between mobile and the base. Path loss can be computed by the help of power control. The signal level of the pilot channel is monitored by the base station and calculates the loss.

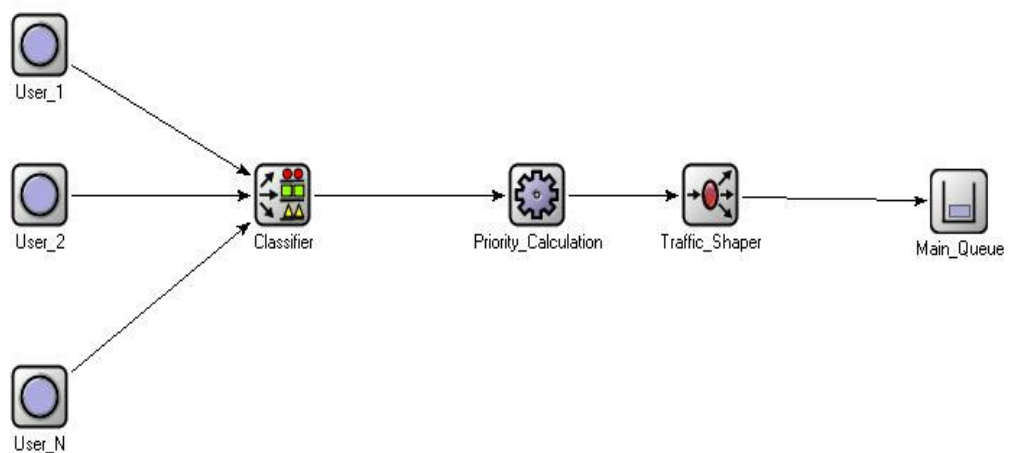

Figure 6-1 OMNET Simulation Model for the Proposed Algorithm

6.1 Priority Calculation:

After base station collects the data it classifies the traffic. The traffic is grouped in three: real time (RT), non-real time (NRT) and guaranteed (G) and, the priority

values are calculated. Real time flows are more sensitive to delays than non-real time flows. Therefore the priority calculation method is different for real time and non-real time flows.

For real time flows priority ξ can be calculated with three different metrics:

- 1) In investigated BER scheduling algorithms the users are granted bandwidth proportional with their data size S and the due time. (t_c current time and t_d is due time)

$$\xi = S/(t_c - t_d) \quad (6-1)$$

- 2) Users are granted bandwidth reversely proportional with their due time. The packets with less time remain before dropping are more prioritized than the others.

$$\xi = 1/(t_d - t_c) \quad (6-2)$$

In above mentioned metrics the second metric is used in our experiments. The users should be served before their time out value to decrease the number of packet drops, thus the packets with less time left should have in higher priority. In MPARS and WISPER the size of the packets also contributes to the priority calculation. The users with higher loads are put in the higher levels in the priority queue. It is known that the video users have larger number of bits to be sent in a frame. That factor gives them more priority so there becomes unfairness between video and other non-real time users.

For non-real time flows a first come first serve mechanism is used and the priorities are calculated due to the generation time of the packets.

$$\xi = 1/t_g \quad (6-3)$$

In our experiments the priority formula given in (6-2) is used for real time traffic and (6-3) is used for non-real time traffic.

The guaranteed users pay more than other users to achieve certain services. When a packet from a guaranteed user comes it is prioritized much more than the other users (This priority mechanism can also be used for the non-real time packets). In our scheduler model, we not only take the priorities of the different traffic types to support QoS, but also we take the priorities of the users into account. Hence, the priorities discussed above are updated as (M is assumed to represent money paid):

$$\xi_{new} = M \cdot \xi \quad (6-4)$$

6.2 Dynamic Gain Adjustment

After priority calculation the data packet batches are divided to individual packets. The duration of a time slot and time frame is adjusted so 1 packet from voice users is sent in one time slot of a one time frame [11].

$$N_{bits} = R_{voice} \cdot t_{frame} \quad (6-5)$$

The constant rate R_{voice} for voice users is 16.5 kb/s. With frame length (t_{frame}) of 15ms approximately 248 bits (N_{bits}) are to be sent in one frame.

$$G = \frac{R_{chip} \cdot t_{slot}}{N_{bits}} \quad (6-6)$$

With a chip rate R_{chip} of 3.84 Mchips/s and slot number of 15 the gain G is found as 16.

The uplink capacity of a CDMA system highly depends on the interference from other users. Therefore deciding the users that will be granted service at the same time slot is very important. Sending same traffic users at the same time slot increases throughput, because the Δ value calculated from the most stringent BER requirement of a user [8]. The users with same BER are sent in the same frame not to waste the capacity. However the performance of this system degrades with different types of traffic at the same time.

$$\sum_k \frac{m_k}{m_k + \rho_k} < 1 - \Delta \quad (6-7)$$

m_k is the number of code slots used by user k , Δ is found in equation (4-10) and ρ_k is:

$$\rho_k = \frac{1.5G_k}{\gamma_k} \quad (6-8)$$

Where γ is the SNR required for the service k . In our protocol the gain G_k are adjusted to have the same ρ_k value such that the idea of BER requirement can be used for all types of services with granting different types of flows at the same time slot without wasting the capacity. We use a variable gain technique to equalize the ρ_k value for all service types. It should be noted that the optimal G value is not found. It was taken literature based as 16 for voice users and updated for other services by referencing that value.

After adjustment of gain due to the packet types the larger sized packets are divided into one packet size and then put in to the main queue. The packet size Ω is calculated with spreading gain G of the user owning that packet.

$$\Omega = \frac{t_s R_{chip}}{G} \quad (6-9)$$

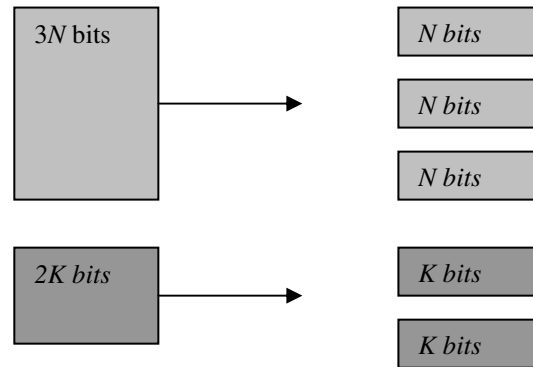

N is the designated packet size of traffic type i .

K is the designated packet size of traffic type j .

Figure 6-2 Packet Division

6.3 Our Algorithm and the Associated Data Structure

We maintain a priority queue in which the packets are put according to their priority levels. Some flows may have same priorities especially the packets divided from the same flow have same priorities. Those are put in the priority queue by a round robin fashion.

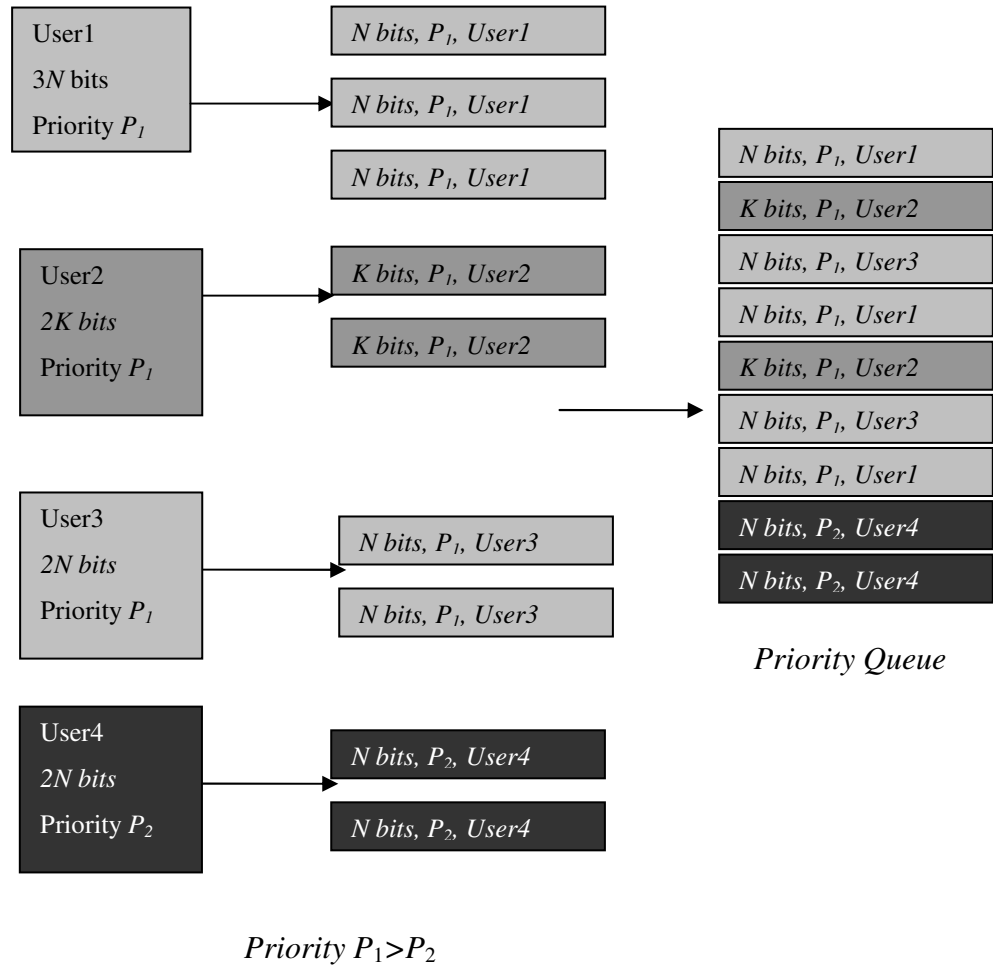

Figure 6-3 Queue Accommodation

The lower part of the priority queue is used for the non-real time packets.

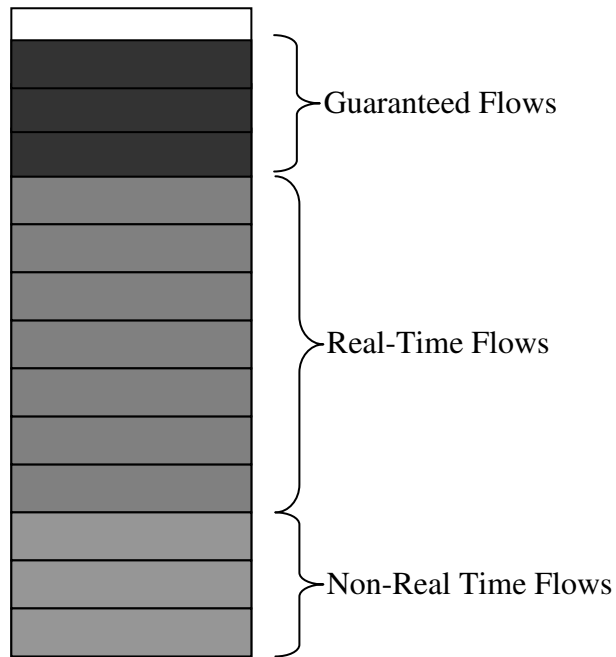

Figure 6-4 Main Queue

Due to that prioritization the capacity is firstly delivered to the real-time and guaranteed flows. After that flows are served the remaining capacity is used for non-real time flows. Non-real time flows are served as best effort.

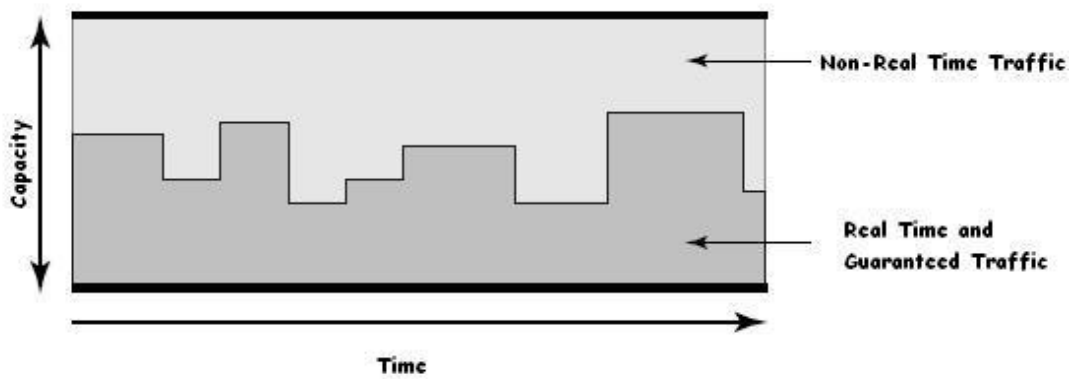

Figure 6-5 Capacity

Packet scheduler gets the packets from the main queue and places them in the time slots. After each placement the scheduler calculates the slot capacity and checks if the maximum capacity is reached. It continues until all the time slots are checked. The algorithm works as follows:

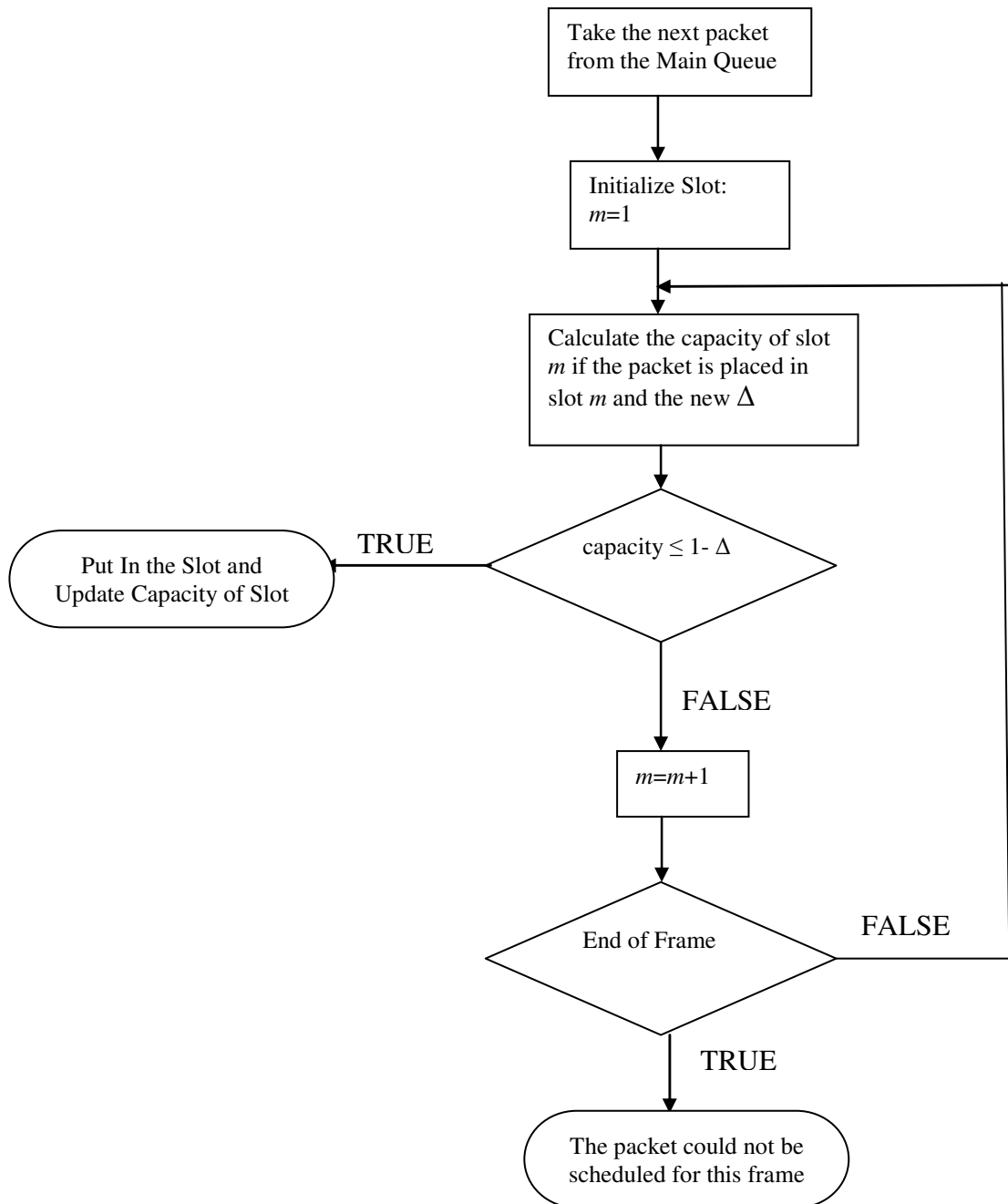

Figure 6-6 Flow Diagram

MPARS algorithm aims to accommodate the users in the time slots due to their service types. The same services are grouped in same time slots. However in our algorithm, by changing the gain value to equalize the ρ the need for grouping same BER required flows is vanished. So the users are taken from the priority queue one by one and accommodated to the time slots until the maximum capacity of the time slot is reached. By the help of that accommodation the worst cases such as different type of traffic packets in the same time slot, which degrade the performance of the MPARS algorithm are eliminated.

The same power allocation method in MPARS is applied in our algorithm. Firstly in the beginning of communication with a user it is assumed that user is sending with the maximum power P_{max} . In the first frame the Δ is determined according to that maximum power level plus path loss value of that user. After allocation of the packets the minimum required power is found to satisfy minimum SNR required with equation (4-3). In the following frame Δ is calculated according to that new calculated power level $P_{calculated}$ plus the path loss value of that user.

In each frame the scheduler tells the mobile station the number of packets it should send and the spreading gain that it should adapt and also the power it should send $P_{feedback}$. The minimum value of that power level is also limited to P_{Min} .

$$P_{feedback} = \max(P_{calculated}, P_{Min}) \quad (6-10)$$

Similar to BER schedulers initially the Δ is determined according to the minimum-power allocation algorithm.

6.4 Utilization Improvement

Our algorithm provides improvement in utilization can be shown as follows:

With the SNR requirements in **Table 6-1** for voice the equation of (6-7) is solved with a Δ of 0.005. It is seen that 15 voice users can be granted at the same time slot.

$$\sum_{k=1}^K \frac{1}{1 + \frac{16 \times 1.5}{1.71}} < 1 - 0.005 \quad (6-11)$$

then $K \cong 15$

With those SNR requirements for video the equation of (6-8) is solved with a Δ calculated above with assuming an average number of code slot used for same video user is 3.

$$\Delta_{voice} = K \frac{1}{1 + \frac{1.5 \times 16}{1.71}} = 0.005$$

$$K = 0.075 \quad (6-12)$$

$$\Delta_{video,16} = 0.075 \frac{1}{3 + \frac{1.5 \times 16}{3.68}} = 0.0079$$

$$\sum_{k=1}^K \frac{3}{3 + \frac{16 \times 1.5}{3.68}} < 1 - 0.0079 \quad (6-13)$$

then $K \cong 3$

Now if we arrange the gain of video users are arranged with our algorithm as 32 then the Δ becomes (assuming the power, background noise and the path loss of the user contributing to the Δ calculation as K . The variation of Δ is investigated with those parameters constant):

$$\Delta_{video,32} = 0.075 \frac{1}{3 + \frac{1.5 \times 32}{3.68}} = 0.0048 \quad (6-14)$$

$$\sum_{k=1}^K \frac{3}{3 + \frac{32 \times 1.5}{3.68}} < 1 - 0.0048 \quad (6-15)$$

then $K \cong 5$

Now further arranging the packets of the same user which are accommodated in different slots the average number of code slot used for same video user becomes smaller than the number assumed above. We can assume 2 for worst case for above assumption. Due to that decrease we expect that Δ becomes larger.

$$\Delta_{video,32} = 0.075 \frac{1}{2 + \frac{1.5 \times 32}{3.68}} = 0.005 \quad (6-16)$$

$$\sum_{k=1}^K \frac{2}{2 + \frac{32 \times 1.5}{3.68}} < 1 - 0.005 \quad (6-17)$$

then $K \cong 7$

The number of packets that can be transferred in a slot is increased with the proposed algorithm. Firstly 3 video users with packet length of P bits were supported now 7 video users with a packet length of P/2 are supported. The improvement on the number of bits is:

$$\frac{7 \times \frac{P}{2}}{3 \times P} = 7/6 \quad (6-18)$$

It is seen that for pure voice users the throughput is similar to the MPARS algorithm, pure video traffic response a little throughput improvement (7/6). We further observe that the throughput is more improved when there are various traffics with voice users, video users at the same time.

Assume that a time slot contains a video user and some voice users put into that time slot because there were no available slots left except that time slot. This case happens in MPARS and WISPER algorithm.

As we found above:

$$\begin{aligned}\Delta_{voice} &= 0.005 \\ \Delta_{video,16} &= 0.0079\end{aligned}\tag{6-19}$$

then

$$\Delta_{max} = \Delta_{video,16} = 0.0079$$

$$\begin{aligned}\sum_{k=1}^K W_{voice} + W_{video} &< 1 - \Delta_{max} \\ \sum_{k=1}^K \frac{1}{1 + \frac{16 \times 1.5}{1.71}} + \frac{1}{1 + \frac{16 \times 1.5}{3.68}} &< 1 - 0.0079\end{aligned}\tag{6-20}$$

$$\text{then } K \cong 12$$

With one video user the number of voice users in the same time slot decreased to 12 from 15. So there are 13 packets in that slot with all bit length of P . Therefore there are $13P$ bits in that time slot.

In the proposed algorithm the gain G of video users are arranged to have the same $\rho = 1.5G/\gamma$ (γ is the SNR required).

$$\begin{aligned}\Delta_{voice} &= 0.005 \\ \Delta_{video,32} &= 0.005\end{aligned}\tag{6-21}$$

then

$$\Delta_{max} = 0.005$$

$$\begin{aligned}\sum_{k=1}^K W_{voice} + W_{video} &< 1 - \Delta_{max} \\ \sum_{k=1}^K \frac{1}{1 + \frac{16 \times 1.5}{1.71}} + \frac{1}{1 + \frac{32 \times 1.5}{3.68}} &< 1 - 0.005\end{aligned}\tag{6-22}$$

$$\text{then } K \cong 14$$

So there are 14 packets in that slot with all bit length of P and a packet with bit length of $P/2$ (video user). Therefore there are $14.5P$ bits in that time slot. The throughput improvement is:

$$\frac{14.5xP}{13xP} = 1.11 \quad (6-23)$$

6.5 Performance Evaluation

We consider the parameters that were given in **Table 3-2** and the traffic is simulated as we discuss in Section 3.6.

The simulation is run by altering the number of active users and averaging statistics for one frame as done in [35] and [11]. In the plots one packet corresponds to 248 bits. The quality of service parameters for those traffics is given as in [9]:

Table 6-1 Service Parameters

Service Type	BER required	SNR required (dB)	Timeout Value (Number of Frames)
Voice	10^{-3}	5.31	2
VBR Video	10^{-6}	11.83	3
Data	10^{-9}	8	1000

The simulations are carried out with 50% voice, 25% video, 25% data user ratios. The proposed algorithm uses the equation (6-2) for priority calculation, because the number of packet drops can be reduced by prioritizing the flows according to their due time.

In the simulations the mobility model contributes to the variation in the path loss. The path that a mobile follows determines how fast the path loss is changing with time. The fast variations in the path loss are a noticeable problem in scheduler performance. The simulations were run with linear mobility model.

6.5.1 Fairness and Service Guarantee

The priority calculation is done for three classes. The fairness among the users of the same class with same priority is maintained. In both WISPER and MPARS BER scheduling algorithms there are unfairness between the video users and the voice users. The priority calculation gave higher priority to the video users because of the larger packet sizes they have. However in our algorithm that factor is eliminated. It can be seen from **Figure 6-11** (which was run for 100 and 200 users) that in our proposed algorithm video packets are dropped more to give capacity for voice users. This reduces the unfairness between video and voice users that we encounter in BER Scheduling algorithms. This is achieved by shaping incoming packets and placing them to the priority slot due to their priorities.

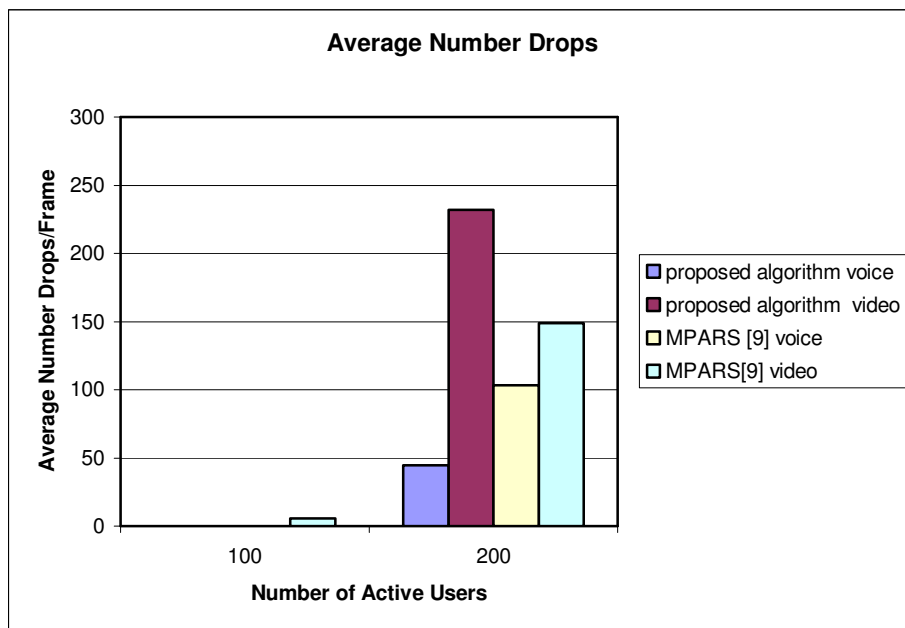

Figure 6-7 Average Number of Drops

As it can be seen the number of dropped packets for video users is increased. As it is said before a video user has more than one data packet however a voice user has one data packet. In the traffic generation model we observed that a video user generates a batch of bits that corresponds to an average of three packets per frame. If the above graphic is normalized with that value we will get the average number of users dropped per frame:

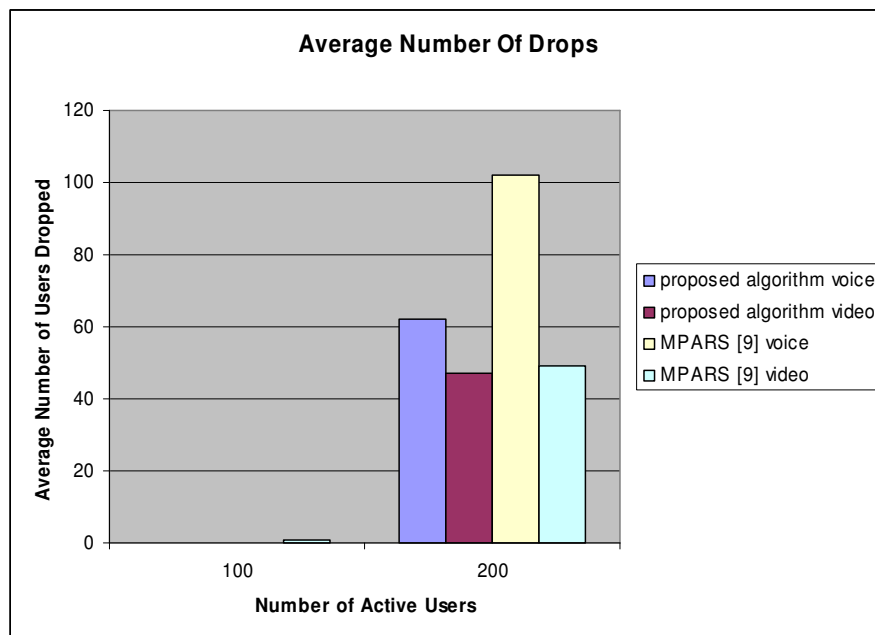

Figure 6-8 Average Number of Dropped Users

As it can be seen there is a deep difference between the number of dropped voice users and the number of the dropped video users. That graph shows the unfairness between the video and voice users in algorithm in [9].

We also conduct experiments to demonstrate our scheduler's support for the guaranteed services. Our scheduler guarantees a fixed bandwidth for the users that pay money for that. Sending all the packets from the guaranteed users is urgent; there should be no packet drops for those users. That payment contributes as money parameter M in our priority calculation. For a simulation run of 95 Video users and

5 voice users with one of them is a guaranteed user, it can be seen that all the packets of the guaranteed user is served. This concept can not be applied to the schedulers observed, because they have not a suitable substructure for that requirement. In our simulation we assume that the user 1 is a guaranteed user and we saw that in WISPER and MPARS that user may come across to packet drops as it is treated as an ordinary user and there can be packet drops for that user as seen in **Figure 6-9** while no packets of the guaranteed user are dropped in our algorithm.

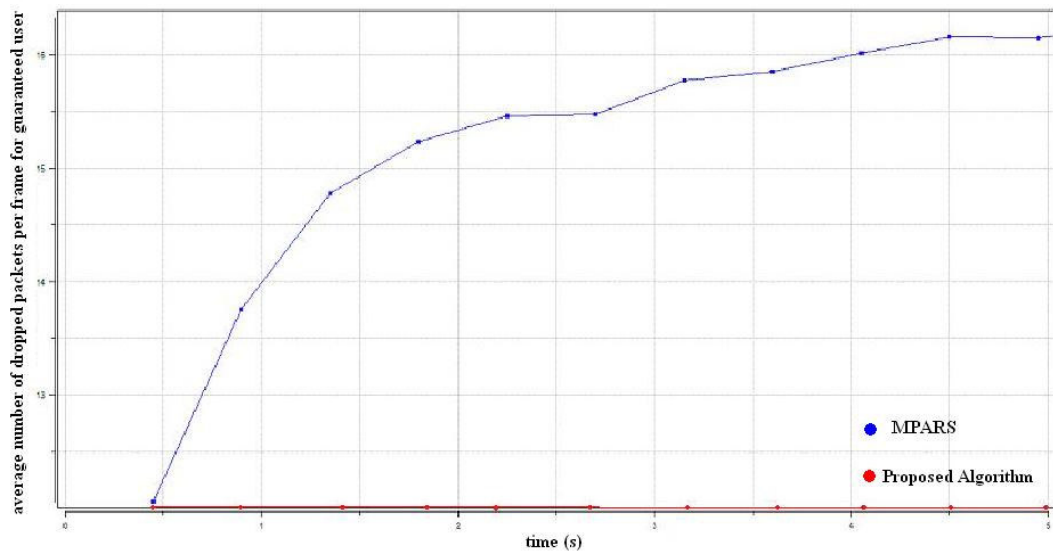

Figure 6-9 Number of Dropped Packets for Guaranteed Flow

It can be seen that to give guaranteed service to specific users. The other users are sacrificed. The average number of drops for video has increased as it can be seen from the below figure:

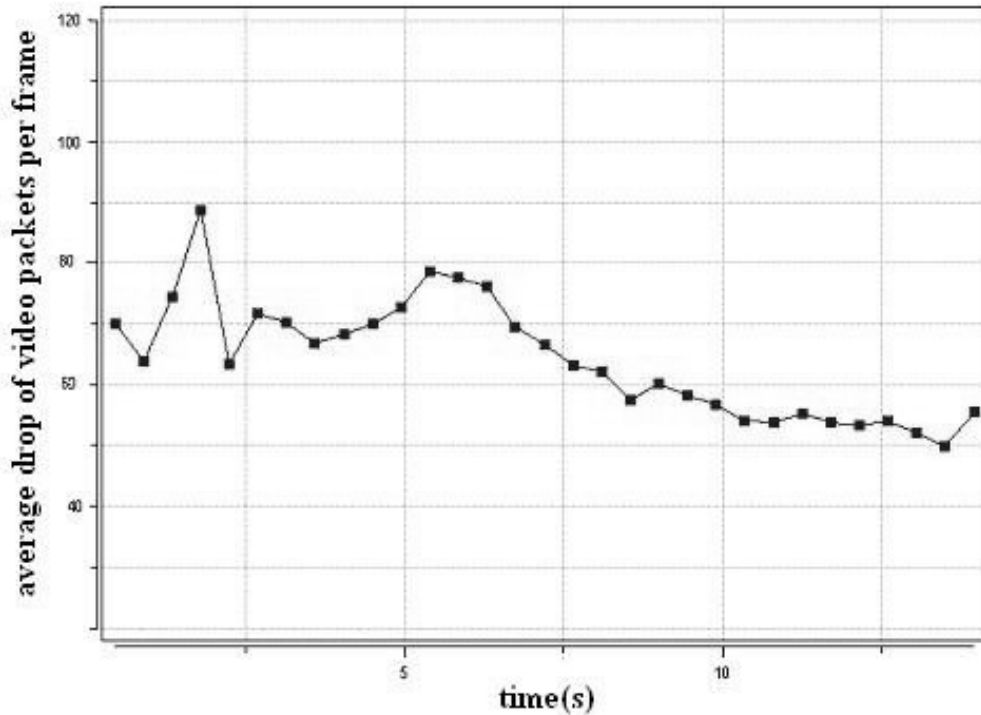

Figure 6-10 Packet Drop of Video Users with Guaranteed Users in Network

It should be noted that the guaranteed users are also prioritized among them. If the system is full of those users some of them will be dropped to satisfy the system capacity.

6.5.2 Throughput

BER scheduling algorithms put same types of packets to the same slots to achieve high utilization [8] and [9]. The idea is that if the system is loaded highly with various types of traffics that schedulers show worse performance. As it is seen from the graph, our proposed algorithm does not decrease the throughput when compared to MPARS and WISPER with various kinds of traffics in high loads. In fact the throughput of our algorithm is slightly better (See **Figure 6-11**).

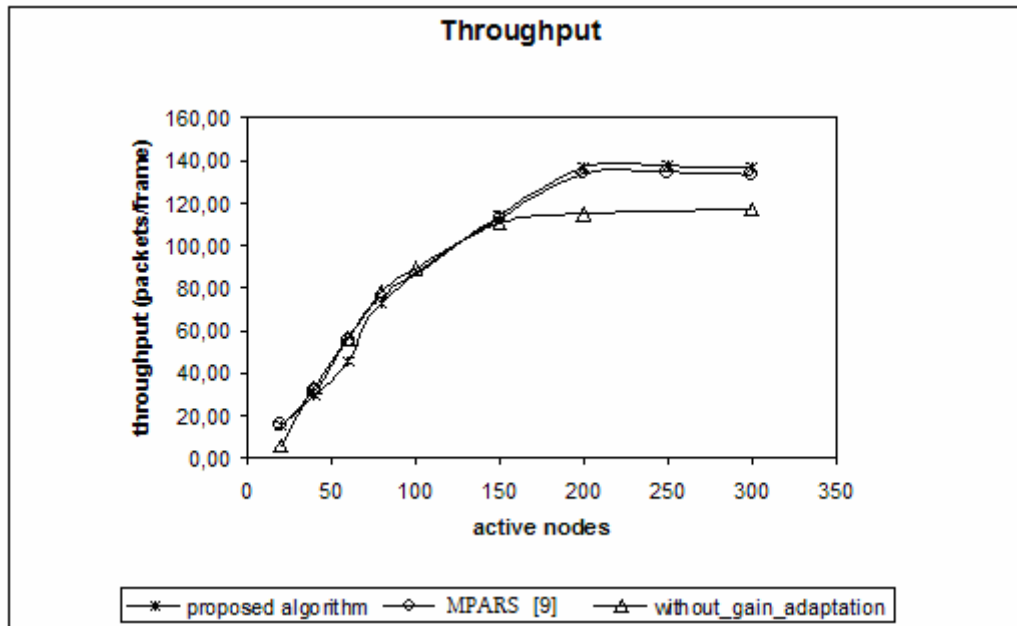

Figure 6-11 Throughput of Mixed Traffic

Our algorithm benefits from the variable gain while MPARS does not. We implement our algorithm without gain adaptation and evaluate its performance to investigate the effect of variable gain. When the gain is fixed the proposed scheduler gives less utilization than MPARS, because the idea of putting same types of packets to the same slots is violated. MPARS make a heuristic bin packing for the active flows and tries to optimize the slot allocation of the users. It tries to accommodate the same traffic types that have the same SNR requirement to the same time slot. However there are worst cases those different types of services but in the same slot. So that slots could not be used with its whole capacity. When the gain variation is added to the system all the services have same ρ_k and the allocating different users in the same slot would not cause worst cases. Eliminating worst case situations in BER scheduling algorithm help to solve bin packing problem in a more compact way; while achieving that throughput the delay and jitter requirements are also satisfied.

Also it is seen that in **Figure 6-7**, which was run for 100 and 200 users, the number of drops for voice users with 100 users is not zero for MPARS algorithm whereas it

is zero for proposed algorithm. This result supports that there is an improvement of the video throughput as it is found in equation (6-18) and the calculations in there. Due to that improvement there is still no packet loss with proposed algorithm whereas MPARS has drops.

If we look further the performance of the proposed scheduler, we see that the after some number of active voice and active video users system becomes saturated. System can handle more voice flows due to the characteristics of the voice traffic. Voice traffic has gaps and mini-gaps that no packets are generated. If we simulate system with pure voice users and pure video users we get the following throughput patterns:

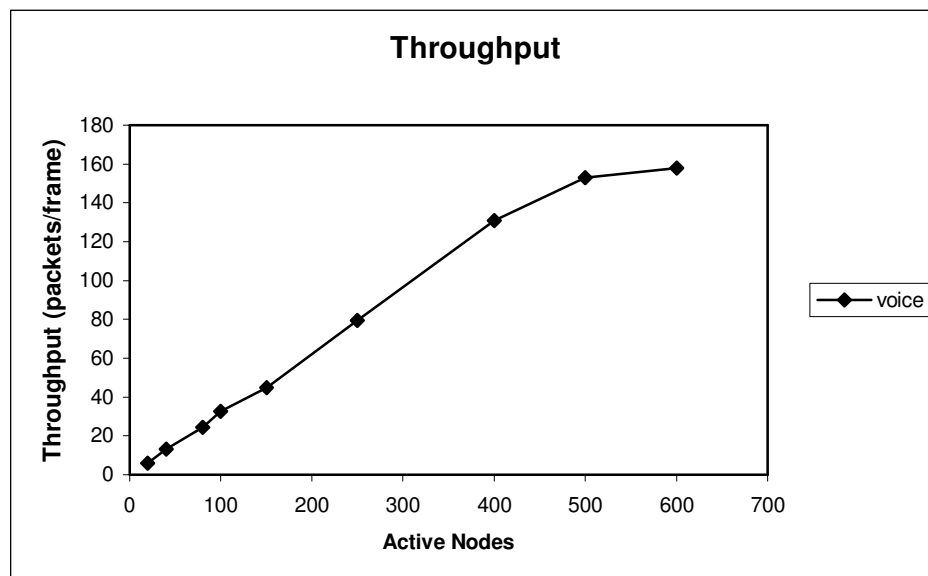

Figure 6-12 Throughput of Voice Users Using Proposed Algorithm

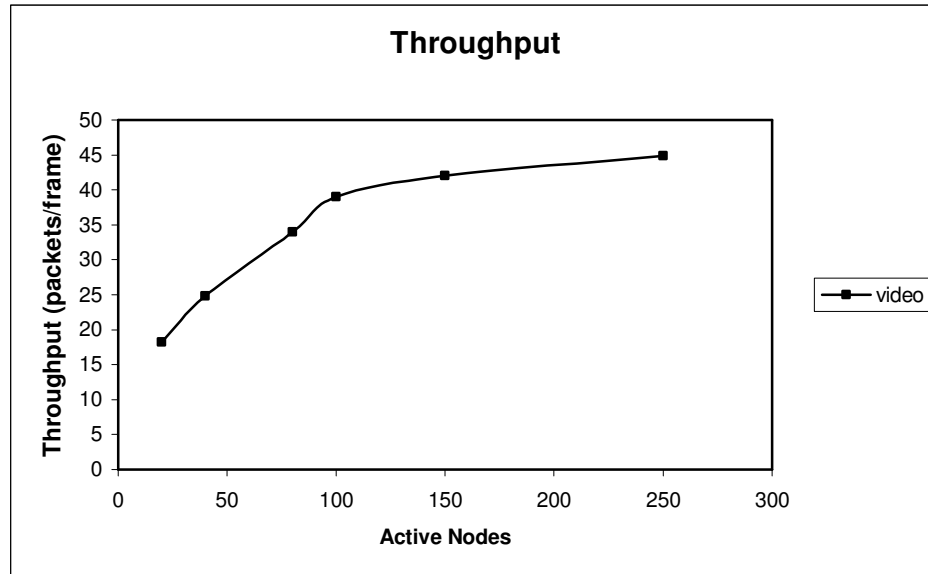

Figure 6-13 Throughput of Video Users Using Proposed Algorithm

The saturation points can be discovered more easily with below graphs. In the below graphs the percentage throughput as defined the ratio of input traffic to the served traffic is given. It can be seen that after some value of active loads the amount of served packets remains the same however input traffic is constant. Due to that percentage of output over input decreases with increasing number of active loads.

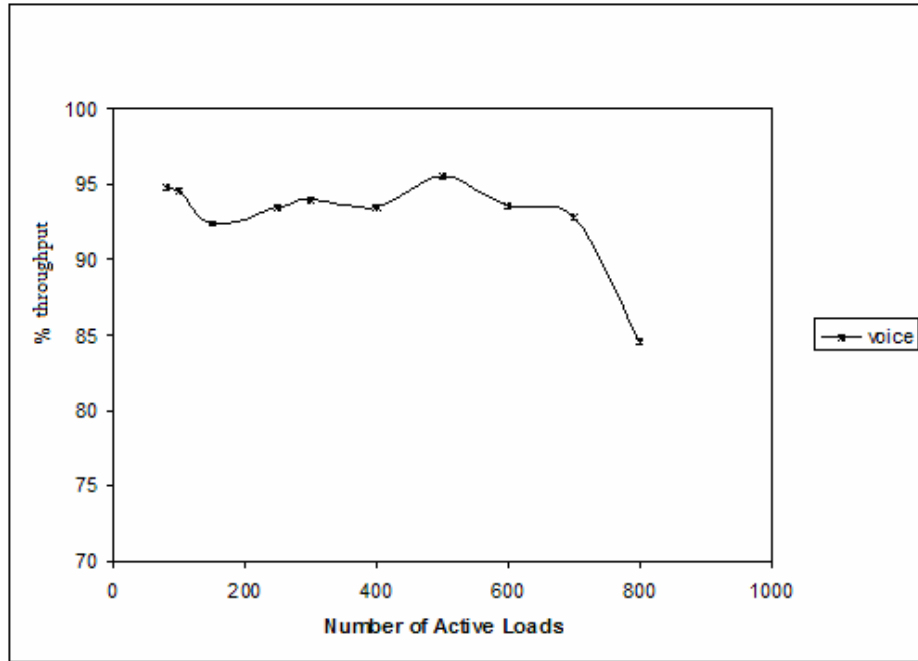

Figure 6-14 Percentage Throughput for Voice Users

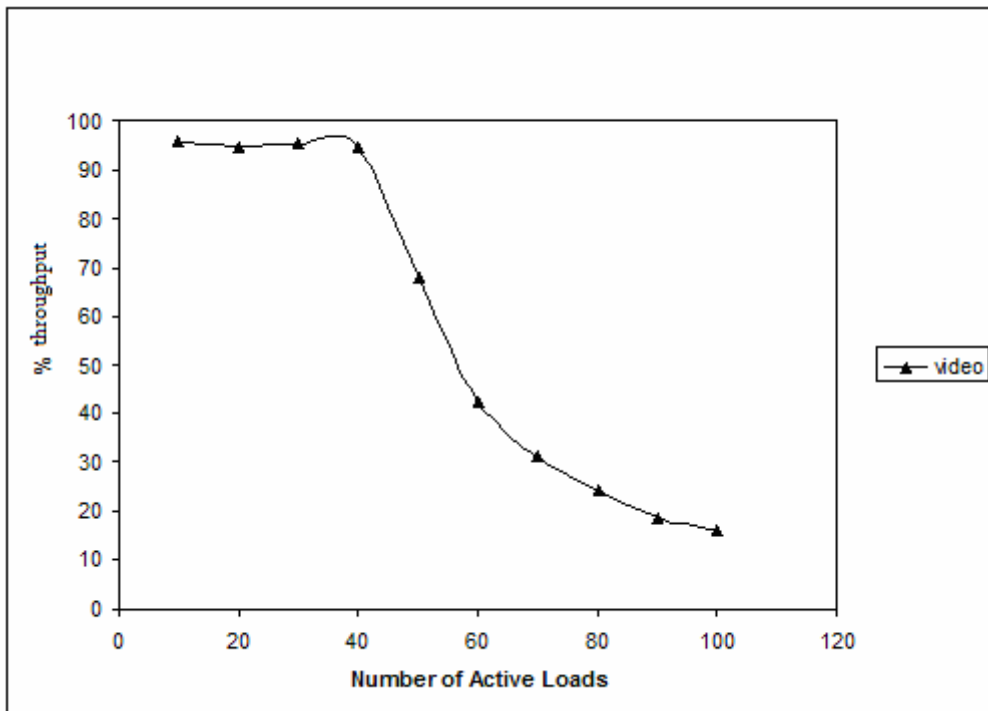

Figure 6-15 Percentage of Output/Input for Video Users

In order to decrease the drop of the packets a connection admission test or in other words admission control policy should be applied to the flows before accepting them to communicate.

In BER scheduling algorithms it is seen that the video packets are served very earlier than their due time. This packets should not be served that fast. The delay of those users is increased to avoid drops for voice traffics. Also gain variation decreased the packet length of the video users that caused an increase in the packet drops of the video services. That is a drawback for our algorithm

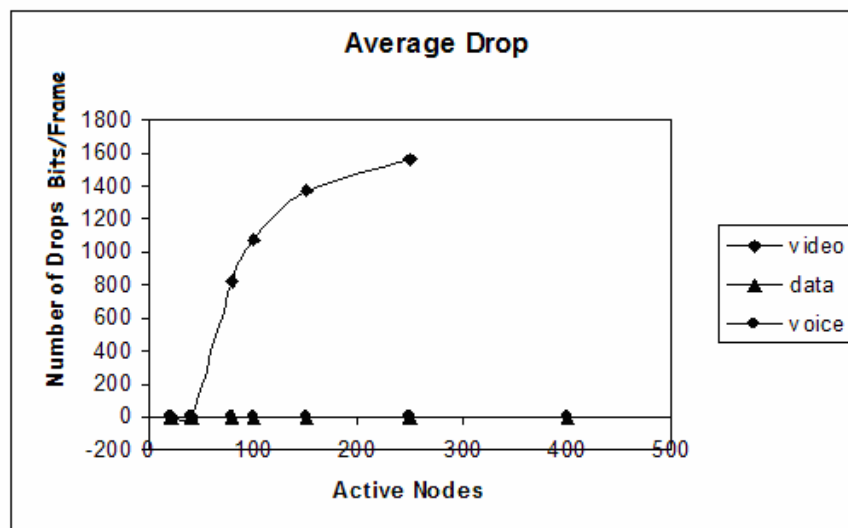

Figure 6-16 Average Drop

6.5.3 Delay Guarantee

Average delay and jitter requirements are satisfied with dropping the packets exceeding their deadline. Deadline of the packet contributes to the priority calculation. The packets whose deadlines are close to simulation time are prioritized more. It becomes urgent to serve those packets. This priority calculation technique decreases the number of dropped packets.

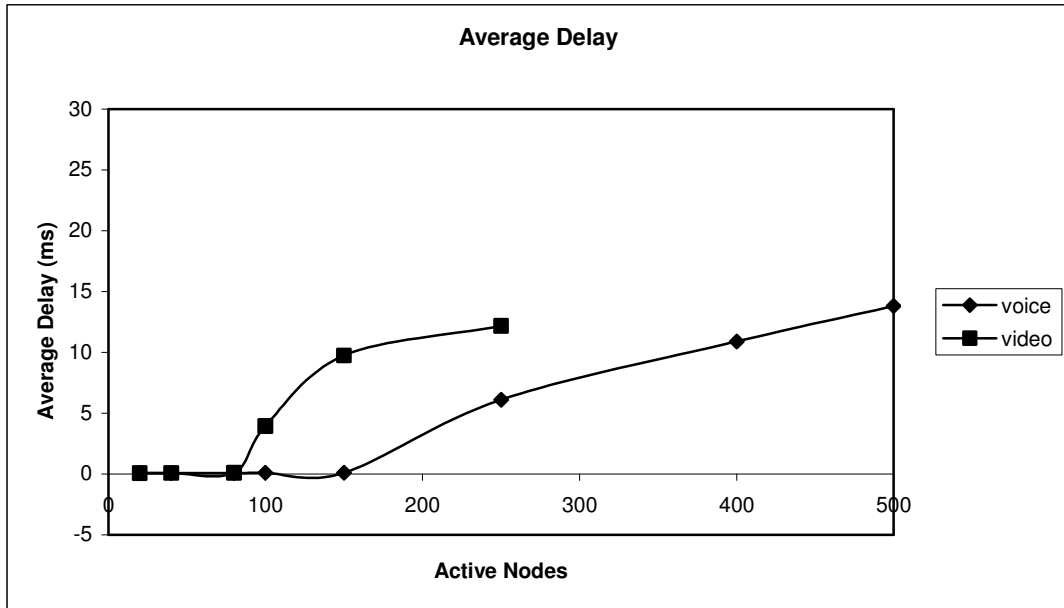

Figure 6-17 Delay Graph for Flows

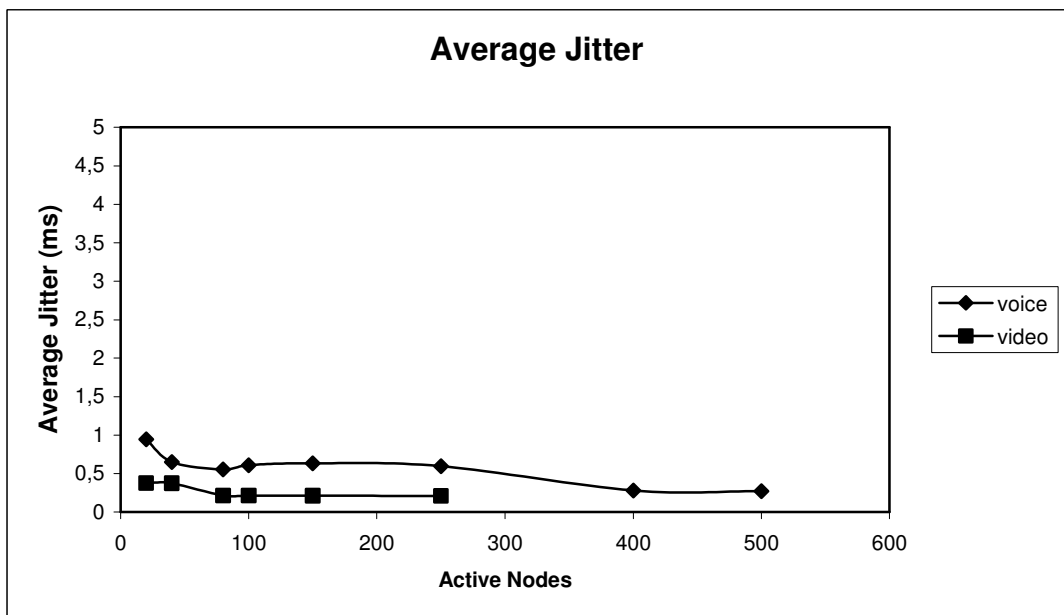

Figure 6-18 Jitter Graph for Flows

The packets that are not served before their due time are dropped. The drops for video users increases fastly after some number of active users. The system can feed more voice users than video users as seen. There is still no packet drop for voice and data users.

6.5.4 Complexity and Stability

The frame length of CDMA is taken as greater than 10ms. This gives the decision time of the scheduler. A scheduler should decide the slot accommodation and calculate parameters for the users in that time interval. That time interval is large enough to take care of that procedure and the complexity is not very critical for schedulers.

Our algorithm consists of four stages:

- Classify flows:

The flows are classified due to their service type. This is done in a single loop. The complexity is $O(N)$ where N is the number of flows.

- Calculate Priority for flow:

Priorities are calculated for each flow. This is done also in a single loop. The complexity is $O(N)$.

- Divide the flows in to one packet length.

The flows are divided into one packet size. For example if a flow of length $M.K$ is divided into K flows of length M then the loop is repeated for K times. So the complexity depends on the size of the flows. The complexity is the multiplication of the number of packets that a flow own and the number of flows however number of flows is more dominant so it can be said as $O(N)$.

- Put in the queue

Users are put into queue due to their priorities. The searching algorithm is implemented here. Firstly one flow is put in the queue and the second flow's priority is compared with the priority of the first flow. This is repeated for every user. The complexity is $O(N)$.

- Accommodate into time slots

The flows are taken from the priority queue and put into the time slots until the maximum capacity of the time slot is reached. This is done in a single loop. The complexity is $O(N)$.

- Calculate minimum power required

After the gain of the flows and the number of code slots they use are found the minimum required power of the users are calculated to satisfy the SNR. This is done also in a single loop. The complexity is $O(N)$.

CHAPTER 7

CONCLUSION

CDMA communication provides secure communication with less power and provides higher capacity than the other multiple access techniques. Hence, CDMA communication technique is promising for the future wireless and mobile networks. In CDMA users generate interference to other users, thus a scheduler mechanism is required to govern channel access.

In this thesis, first selected WISPER and MPARS schedulers in literature for resource scheduling in time slotted-CDMA communication systems are implemented in OMNET simulation environment. Simulation experiments are conducted to investigate the performance of these schedulers.

The results of our performance analysis for WISPER and MPARS show that those algorithms bring the idea of serving same service packets with same BER at the same time slot which optimizes the slot allocation. The minimum power allocation principle in MPARS further increases the utility. However those algorithms could not optimize the slot accommodation in mixed traffic where there are various kinds of services requiring different BER. Addition to that the priority calculation of those algorithms brings unfairness between the users having more packets and the users having less packets. Also there is no support for guaranteed services.

Next a new adaptive resource scheduler with QoS support for time slotted CDMA systems is proposed. The proposed scheduler supports real-time, non-real time and guaranteed services. It is a variable gain scheduler for uplink transmission. It changes the gain of the services to make the gain over SNR requirement same for

all the flows. That is the generalization of the idea proposed in BER scheduling algorithms. The new scheduler supports guaranteed flows by prioritizing them more than the other flows. Also the priority calculation is done without considering the size of the packet of the flows which removed the unfairness seen in BER schedulers.

The performance of the proposed scheduler is evaluated in comparison to the WISPER and MPARS schedulers. The guaranteed flows aren't supported in MPARS and WISPER, the packets from those users are treated as any other users and can be dropped during the simulation. However with new algorithm they are not dropped. It should be noted that the number of guaranteed flows that system can support is limited. That limit can be updated by connection admission algorithms. Besides that other QoS metrics such as delay and jitter is also investigated and it is seen that they are limited as in MPARS and WISPER. Also the fairness comparison is made and the graph for number of dropped users is obtained. It is seen that the deep difference between the number of drops of video and voice users in MPARS algorithm is decreased in the new algorithm. Finally the throughput simulations are made with mixed traffic which has a certain percentage of voice, video and data users. It is noticed that the utility optimization decreases in BER scheduling algorithms because the probability of being in the same time slot for the packets from the users with different BER requirements is increased with mixed traffic. The gain variation slightly increased the throughput in that type of traffic profile.

Future work includes applying the proposed scheduler idea to downlink transmission. Designing a connection admission test for the proposed scheduler to decrease the packet loss ratio is also considered. Due to the soft capacity of the CDMA system the connection admission test can yield a certain packet loss probability for a connection that is to be admitted to the network.

In our experiments in the OMNET simulation environment, the simulator variation of slot number and time slot duration are not tested. There can be optimal values for those parameters. This will be a significant research topic in that area.

Also the complexity of the code should be investigated. There can be more intelligent codes that reduce computation complexity of the algorithm. The algorithm assumes single cell operation and the intercell interference is taken as a probabilistic distribution. In real network the base stations coordinates with each other. In the network due to the mobility model the users' moves inside the cell handoff mechanism are not implemented.

REFERENCES

- [1] A. Sampath, P.S, Kumar and J. M. Holtzman “Power Control Resource Management for Multimedia CDMA Wireless System,” *IEEE Personal, Indoor and Mobile Radio Communications Conference (PIMRC)*, pp. 21-26, September 1995.
- [2] M. A. Arad and A. Leon-Garcia, “A Generalized Processor Sharing Approach To Time Scheduling In Hybrid CDMA/TDMA,” *IEEE Computer and Communications Societies Conference (INFOCOM)*, pp. 1164-1177 March 1998.
- [3] P.Y. Kong, “A Generalized Processor Sharing Approach to Resource Allocation for QoS in Multicode-CDMA Networks,” *57th IEEE Semiannual*, vol.3, pp. 1950-1954, April 2003.
- [4] M. A. Arad and A. Leon-Garcia, “Scheduled CDMA: A Hybrid Multiple Access For Wireless ATM Networks,” *IEEE Personal, Indoor and Mobile Radio Communications Conference (PIMRC)*, vol. 3, pp. 913-917 October 1996.
- [5] Ö. Gürbüz and H. Owen, “Dynamic resource scheduling (DRS): a multimedia QoS framework for W-CDMA,” *Wireless Communications and Mobile Computing*, vol. 4, pp. 529-546, 2004.
- [6] Ö. Gürbüz, H. Owen “Dynamic Resource Scheduling Strategies For QoS in W-CDMA,” *IEEE Global Telecommunications Conference (GLOBECOM)*, vol. 1A, pp. 183-187, December 1999.
- [7] Ö. Gürbüz and H. Owen, “Power Control Based QoS Provisioning for Multimedia in W-CDMA,” *Kluwer Academic Publishers Wireless Networks* vol. 8, pp. 37–47, 2002.
- [8] I. F. Akyıldız and D. A. Levine, “A Slotted CDMA Protocol with BER Scheduling for Wireless Multimedia Networks,” *IEEE/ACM Transactions On Networking*, vol. 7, no. 2, pp. 146-158, APRIL 1999.

- [9] X. Wang, "Wide-Band TD-CDMA MAC with Minimum-Power Allocation and Rate- and BER-Scheduling for Wireless Multimedia Networks," *IEEE/ACM Transactions on Networking*, vol. 12, no. 1, pp. 103-116, February 2004.
- [10] V. Huang and W. Zhuang, "QoS Based Fair Resource Allocation in Multi-Cell TD/CDMA Communication Systems," *IEEE Transactions On Wireless Communications*, vol. 5, no. 2, pp. 339-346, February 2006.
- [11] V. Huang and W. Zhuang, "QoS-Oriented Packet Scheduling for Wireless Multimedia CDMA Communications," *IEEE Transactions On Mobile Computing*, vol. 3, no. 1, pp. 73-85, March 2004.
- [12] J. B. Kim and M. L. Honig, "Resource Allocation for Multiple Classes of "DS-CDMA Traffic," *IEEE Transactions On Vehicular Technology*, vol. 49, no. 2, pp. 506-519, March 2000.
- [13] P. Newson and M. R. Heath "The Capacity of a Spread Spectrum CDMA System for Cellular Mobile Radio with Consideration of System Imperfections," *IEEE Journal On Selected Areas In Communications*, vol. 12, no. 4, pp. 673-684, May 1994.
- [14] V. Srivastava, J. Neel, A. B. Mackenzie, R.A. Menon, L. A. Dasilva, J. E. Hicks, J. H. Reed, and R.P. Gilles, "Using Game Theory To Analyze Wireless Ad Hoc Networks," *IEEE Communication Surveys*, vol. 7, no. 4, Fourth Quarter 2005.
- [15] Z. Liu, M. J. Karol, M. E. Zarki, and K. Y. Eng, "Channel access and interference issues in multi-code DS-CDMA wireless packet (ATM) networks," *Wireless Networks*, vol. 2, pp. 173-193, 1996.
- [16] R. Prasad and T. Ojanperä, "An Overview of CDMA Evolution toward Wideband CDMA," *IEEE Communications Surveys*, vol. 1 no. 1, Fourth Quarter 1998.
- [17] X. Wang and H. V. Poor, "Wireless Communication Systems: Advanced Techniques for Signal Reception," *Prentice Hall Communications Engineering and Emerging Technologies Series*, 2002.

- [18] J. G. Proakis, "Digital Communications," *Mc. Graw Hill Inc.*, 3rd edition, 1995.
- [19] M.Haardt, A. Klein, R.Koehn, S. Oestreich, M.Purat, V. Sommer and T. Ulrich, "The TD-CDMA Based UTRA TDD Mode," *IEEE Journal On Selected Areas In Communications*, vol. 18, no. 8, August 2000.
- [20] J. R. Koza, "Genetic Programming," *MIT Press*, 1992.
- [21] T. S. Rappaport, "Wireless Communications: Principles and Practice," *Prentice Hall*, 2nd ed., 2002.
- [22] H. Fattah and C. Leung, "An Overview of Scheduling Algorithms in Wireless Multimedia Networks," *IEEE Wireless Communications*, pp. 76-73, October 2002.
- [23] K. Tachikawa, "W-CDMA: Mobile Communications System," *John Wiley & Sons Ltd.*, 2002.
- [24] S. G. Glisic, "Adaptive WCDMA Theory and Practice," *John Wiley & Sons Ltd.*, 2003.
- [25] V.A. Dubendorf, "Wireless Data Technologies," *John Wiley & Sons, Ltd.*, 2003.
- [26] A. Goldsmith, "Wireless Communications," *Cambridge University Press*, 2005.
- [27] 3GPP [Online]. Available: <http://www.3gpp.org>.
- [28] OMNET++ [Online]. Available: <http://www.omnetpp.org>.
- [29] ChSim [Online]. Available: <http://wwwcs.upb.de/cs/cn/projects.html>.
- [30] MTS "Selection Procedures for the Choice of Radio Transmission Technologies of the UMTS," *MTS 30.03*, ver. 3.2.0, 4-1998.
- [31] G. Stuber and B. Jabbari, "Multi-Access, Mobility & Teletraffic For Wireless Communications," *Kluwer Academic*, vol. 5, 2000.

- [32] Z. Dawy, S. Davidovi'c and A Seeger, "The Coverage–Capacity Tradeoff in Multiservice WCDMA Cellular Systems with Serial Interference Cancellation," *IEEE Transactions on Wireless Communications*, vol. 5, no. 4, April 2006.
- [33] A. Varga, "OMNET++ Discrete Event Simulation System Version 3.2 User Manual," March 29, 2005.
- [34] S.Bilgen, "Benzetim Sonu'clarının Gu'venilirliđi," *METU*.
- [35] K. Kang, J. Cho and H. Shin "Dynamic Packet Scheduling for cdma2000 1xEV-DO Broadcast and Multicast," *IEEE Communications Society / WCNC*, 2005.
- [36] S. Oh and K. M. Wasserman "Dynamic Spreading Gain Control in Multiservice CDMA Networks," *IEEE Journal on Selected Areas in Communications*, vol. 17, no. 5, May 1999.