

THE EVOLUTION OF TOILETS AND ITS CURRENT STATE

A THESIS SUBMITTED TO
THE GRADUATE SCHOOL OF NATURAL AND APPLIED SCIENCES
OF
MIDDLE EAST TECHNICAL UNIVERSITY

BY

MELDA GENÇ

IN PARTIAL FULFILLMENT OF THE REQUIREMENTS
FOR
THE DEGREE OF MASTER OF SCIENCE
IN
INDUSTRIAL DESIGN

FEBRUARY 2009

Approval of the thesis:

THE EVOLUTION OF TOILETS AND ITS CURRENT STATE

submitted by **MELDA GENÇ** in partial fulfillment of the requirements for the degree of **Master of Science in Industrial Design Department, Middle East Technical University** by,

Prof. Dr. Canan Özgen
Dean, Graduate School of **Natural and Applied Sciences**

Assoc. Prof. Dr. Gülay Hasdoğın
Head of Department, **Industrial Design**

Dr. Canan Emine Ünlü
Supervisor, **Industrial Design Dept. , METU**

Examining Committee Members:

Assoc. Prof. Dr. Mehmet Asatekin
Industrial Design Dept. , METU

Dr. Canan Emine Ünlü
Supervisor, Industrial Design Dept. , METU

Asst. Prof. Dr. Naz Börekçi
Industrial Design Dept. , METU

Dr. Hakan Gürsu
Industrial Design Dept. , METU

Assoc. Prof. Dr. Candan Terwiel
Department of Ceramics, Hacettepe University

Date: *13 February 2009*

I hereby declare that all information in this document has been obtained and presented in accordance with academic rules and ethical conduct. I also declare that, as required by these rules and conduct, I have fully cited and referenced all material and results that are not original to this work.

Name, Last Name: Melda Genç

Signature:

ABSTRACT

THE EVOLUTION OF TOILETS AND ITS CURRENT STATE

Genç, Melda

M. Sc., Department of Industrial Design

Supervisor Dr. Canan E. Ünlü

February 2009, 109 pages

Vast consumption of natural resources threatens the human life. Growing scarcity of fresh water is posing a great challenge to humanity as well. Thus many governments take special measures for efficient use of freshwater. There are many products that use too much fresh water. Toilet is among these products. In search of new solutions for lack of fresh water, designers design alternative toilets. However, it is necessary to understand the evolution of toilets and current state to develop better new technologies and products.

This thesis investigates the evolution of toilet design throughout the history. Factors affect toilet design, and changes in their improvement throughout the evolution of toilets are examined. The study also aims to investigate advantages and disadvantages of squat and flushed toilets and their current state.

Keywords: Toilet design, History of toilets, Squat toilet and Flushed toilet

ÖZ

TUVALETLERİN EVRİMİ VE GÜNÜMÜZDEKİ DURUMU

Genç, Melda

Yüksek Lisans, Endüstri Ürünleri Tasarımı

Tez Danışmanı Dr. Canan E. Ünlü

Şubat 2009, 109 sayfa

Son yıllarda doğal kaynaklardaki azalma insan yaşamını tehdit etmektedir. Artan temiz su azlığı insanlık için büyük bir problem haline gelmektedir. Bu problemle mücadele edebilmek için birçok hükümet temiz suyun idareli kullanımı için özel önlemler almaktadır. Aşırı su tüketimine sebep olan pek çok ürün vardır ve bunlardan biri de tuvaletlerdir. Azalan temiz su problemine yeni çözümler aranması doğrultusunda tasarımcılar alternatif tuvaletler tasarlamaya çalışmaktadır. Ancak, bu konuda yeni teknolojiler ve ürünler geliştirmek için tuvaletlerin tarih boyunca evrimini ve günümüzdeki durumunu bilmek gereklidir.

Bu tez tuvalet tasarımının tarih boyunca gelişimini incelemektedir. Tuvaletlerin tarih boyunca evrimi içerisinde tuvalet tasarımının değişimi, bugünkü durumu ve bu süreci etkileyen faktörler belirlenmeye çalışılmaktadır. Helâ taşı ve klozet tasarımlarının avantajları ve dezavantajları ile günümüzdeki durumu araştırılmaktadır.

Anahtar Kelimeler: Tuvalet tasarımı, Tuvaletlerin tarihi, Helâ taşı, Klozet

To My Parents

ACKNOWLEDGMENTS

I would like to express my thanks to my supervisor Dr. Canan E. Ünlü for her guidance, advice, criticism, encouragement and great patience throughout this research.

I would also like to thank Şahika Genç, Geoffrey Rose, Öge Devrim Sağlam, Bahar Sağlam, Ezgi Abacı and Vitra firm for their suggestions and comments.

TABLE OF CONTENTS

ABSTRACT	iv
ÖZ	v
ACKNOWLEDGEMENTS	vii
TABLE OF CONTENTS	viii
LIST OF TABLES.....	viii
LIST OF FIGURES	x
CHAPTERS	
1. INTRODUCTION	1
1.1 Background of the Problem	1
1.2 Aim of the Study.....	3
1.3 Significance of the Study and Structure of the Thesis.....	4
2.LITERATURE REVIEW.....	5
2.1 Evolution of Toilets Throughout the History.....	6
2.1.1 History of Flushed Toilets	7
2.1.1.1 Ancient Times	8
2.1.1.2 Middle Ages	21
2.1.2 History of Squat Toilets.....	27
2.1.2.1 World.....	27
2.1.2.4 Anatolia	30
2.1.3 Toilets in 1500s to 1700s.....	37
2.2 Materials used in Toilet Production.....	59
2.3 Advantages and Disadvantages of Squat and Flushed Toilets.....	61
2.3.1 Comparison of Squatting and Sitting position.....	62
2.3.2 Toilets as Sustainable Alternatives.....	64
2.3.3 Sanitation without Water: Ecological Toilets.....	68
2.3.4 Attempts to Combine Flushed Toilets.....	72
2.3.5 Attempts to Combine Squat Toilets	76
2.3.4 Comparison of Flushed Toilets with Squat Toilets	78

2.4 A Brief Overview of Turkish Ceramic Sanitary ware Production.....	78
3. CONCLUSION	88
REFERENCES	94
APPENDIX	105
APPENDIX A.Timeline of Toilet Evolution	105

LIST OF TABLES

Table 2.1	Table of Basic Squat Toilet Types	36
Table 2.2	Comparison of Squat and Flushed Toilets	78
Table 2.3	Ceramic Sanitary ware Production of Europe (1000 unit).....	80
Table 2.4	Twelve Ceramic Sanitary ware Firms in the World.....	80

LIST OF FIGURES

Figure 2.1	Flushed, Squat and Urinal Toilets.....	7
Figure 2.2	Toilet and Bathing Area in Mohenjo-Daro in Indus Valley	10
Figure 2.3	Stone Bench or Limestone from the Ancient Egypt.....	12
Figure 2.4	Section and Plan of Ground-Floor Toilet at King Minos’s Royal Palace in Knossos.....	13
Figure 2.5	Latrines at Knossos Crete 1700 BC	13
Figure 2.6	Lavatory and Types of Lavatory’s Seats in Ancient Greeks	15
Figure 2.7	Garbage Toilet Disposal	17
Figure 2.8	Toilet Cleaning Tool Stick with a Sponge at the End.....	17
Figure 2.9	Roman Latrine in Dougga, Located in Today’s Tunisia	18
Figure 2.10	Hypothetical Reconstruction of Latrines in Rome	18
Figure 2.11	Socialization in Toilet.....	19
Figure 2.12	Latrina in Metropolis	20
Figure 2.13	A Scene From in Middle Ages	21
Figure 2.14	A Silver Chamber Pot.....	22
Figure 2.15	Elizabethan Chamber Pot.....	23
Figure 2.16	The Garderope in Tower of London	24
Figure 2.17	A Toilet in the White Tower.....	25
Figure 2.18	Garderoles in Southwell Palace	25
Figure 2.19	Fujiwara Toilet in Japan	28
Figure 2.20	Traditional Tibetan Toilet in the Potala Palace in Lhasa, China	29
Figure 2.21	The Toilet in Erzincan Üzümlü	31
Figure 2.22	Ottoman Toilets in Bodrum Museum	32
Figure 2.23	Toilet from Topkapı Palace	33
Figure 2.24	The Castle of Saint Peter at Halicarnassus	34
Figure 2.25	“V” Type Toilets in Safranbolu Houses	35
Figure 2.26	An Example of Squat Toilets in Safranbolu Houses	35
Figure 2.27	Royal Close Stool at Hampton Court	38
Figure 2.28	Cumming’s Metal Valve Toilet 1775 Mechanism	39

Figure 2.29	Alexander Cumming's Toilet	40
Figure 2.30	Alexander Cumming's Valve Toilet.....	41
Figure 2.31	Bramah's Valve Toilet, 1778.....	42
Figure 2.32	Victorian Toilets from a Catalogue	43
Figure 2.33	Franz Weidl's Hand Bidet Design	46
Figure 2.34	Henry Doulton's Toilet with Art Nouveau Decoration, 1912	46
Figure 2.35	Jennings's Syphonic Toilet.....	47
Figure 2.36	Examples of Ceramic Bowls for the Twyford Toilets.....	48
Figure 2.37	Thomas Twyford's Valve Toilet Ceramic Bowl Catalogue	49
Figure 2.38	Valve Toilet With a Bowl	49
Figure 2.39	Two Pieces and One Piece Units Washout Toilets.....	50
Figure 2.40	Twyford 1898 Catalogue	51
Figure 2.41	1929 Twyford's Syphonic WC.....	53
Figure 2.42	Earthen ware Wc, Stone ware WC, Cane and White ware WC	54
Figure 2.43	1950's Toilet Sample.....	55
Figure 2.44	Gio Ponti's Toilet Design	55
Figure 2.45	Double Trap Symphonic WC Suite	56
Figure 2.46	The Section of Squat Toilets.....	58
Figure 2.47	The Section of Flushed Toilets	58
Figure 2.48	Stainless Steel Squat Toilets.....	59
Figure 2.49	Plastic Squat Toilets.....	60
Figure 2.50	Public Squat (Squatting-Type) Toilet Design.....	63
Figure 2.51	Anorectic Angle in Two Different Positions of Bowel Evacuation ..	63
Figure 2.52	Water Use at Home.....	64
Figure 2.53	Dual Flushed Toilets.....	66
Figure 2.54	Serel Smart Asma Toilet.....	66
Figure 2.55	Henry Moule Earth Toilet.....	67
Figure 2.56	Collection of Various Sources of Waste Waters in a Single Pipe	69
Figure 2.57	Ecological Sanitation	70
Figure 2.58	Examples of Waterless Toilets	71
Figure 2.59	Alternative Ways of Handling and Using Urine Diverted from Toilets	72

Figure 2.60	Squatting Pan with Urine Diversion	72
Figure 2.61	William Bliss's Design	73
Figure 2.62	Portable Squat Support	74
Figure 2.63	Sitting/Squatting Water Toilet	74
Figure 2.64	Adjustable Toilet Bowl Seat and Footrest	75
Figure 2.65	Sadun Ersin's design of an attempt to combine Squat and Flushed toilets presented	75
Figure 2.66	Jonathan P.Isbit's Toilet Accessory	76
Figure 2.67	The Parts Attempt to Squat Toilet	77
Figure 2.68	Accessories of Handles to Hold.....	77
Figure 2.69	The Production of Toilets	84
Figure 2.70	A Squat Toilet designed by Gamze Türkoğlu Akay and İnci Mutlu for Eczacıbaşı VitrA	87
Figure 2.71	VitrA Squat Toilet	87
Figure 2.72	Toilet Examples from Ancient Times to 17th Century.....	89

CHAPTER 1

INTRODUCTION

1.1 Background of the Problem

The rapid increase in the world population brings new challenges to conservation and sustainable use of natural resources. How researchers, designers, and developers respond to these new challenges *today* will have significant impact on the *future* of humanity.

Water is the most vital natural resource, and is crucial for the survival of nature and humanity. Its regional and seasonal availability and the quality of surface and groundwater highly influence the environment, economic growth and development of countries. It is predicted that in the future, “people would start wars for fresh water (white gold) rather than oil (black gold) (Carter, 2006)” since many countries in the world have been facing ever-growing water shortage. Turkey is one of those countries; for instance, in 1960, the population of Turkey was 28 million and there was 4000 liters fresh water per person per year. In 2000, the population doubled and now there is 2700 liters fresh water per person. Based on the recent projections, our population will reach 100 million in 2030 and there will be 1400 liters left per person. This proves that our country will face challenges in getting fresh water to its residents (“Kişi başına,” 2008).

There are many endeavors at local and global scales in various fields working on solutions to the potential water problem of the world; scientists are trying to find alternatives by developing water reuse systems while manufacturers of consumer goods are offering products that help to reduce water consumption. Producing water-efficient and environment friendly toilets is one of those endeavors mentioned above. Toilets are one of the most important and most used sanitary ware products. It

is not difficult to guess the significance of the influence of toilet usage on water consumption since, especially in the cities, everyone has at least one toilet in his house, and an average healthy person spends 11.5 minutes per day (nearly 70 hours per year) in toilets and consumes water (Oddie, 1986).

Today, more manufacturing companies are developing high efficiency toilets that consume less water while keeping their high standards on hygiene and comfort (Varlık, 2008). Moreover, there are alternative toilets such as waterless ecological toilets, composting, and earth toilets. Besides lately, squat toilets are accepted by the scientists as alternative toilets. A squat toilet that is prevalent in parts of Asia, Europe and Africa. However, by modernization in every means, squat toilets are losing their popularity *despite* their water-efficiency. Until the last twenty years, squat toilets were used in majority of the houses in Turkey except the metropolitan areas. Today, in the new houses in Turkey, squat toilets are not as common as they were before (Varlık, 2008).

Today, there are three types of toilets widely used in the world; namely they are flushed, squat, and urinal type toilets. By considering the flushed and urinal type toilets as they have western roots, squat type toilets are called eastern style toilets and in many places they are known as Turkish style or squat toilets. In this sense, western style toilets are called flushed toilets.

The toilet sector of all types is becoming a significantly large market in the world. Modern toilet manufacturers in Turkey that have a significant share in respectable markets, and others around the world are in a race to design toilets. Increasing competition among the firms, brand creation in the market, standardization as a result of the industrialization, and increasing focus on environment and sustainability caused the firms to emphasize the design more in order to get ahead of their competitors.

Especially for Turkish toilet manufacturers, new alternative toilet designs could provide a chance to differentiate themselves in the global market by being eco-friendly and sustainable which are among main advantages of squat toilets compared to flushed toilets. From this perspective, it would be beneficial to start with understanding the roots, evolution, and current status of Squat and flushed toilets.

The knowledge generated in this thesis towards understanding squat and flushed toilet designs throughout history may contribute to the future developments in designs of these toilets and toilet production of sanitary ware sector.

1.2 Aim of the Study

The aim of this study is to contribute to the field of sanitary ware design by pointing to toilets as overlooked alternative solutions especially for reducing water consumption. For this end, particularly the case of the history of toilets should be explored in order to construct a further argument on their advantages. By considering their benefits, stating the current situation of toilets production and usage in the world might let related sectors take aim at new targets.

Consequently, the main research question of this study is as follows:

- What is the toilet's case throughout the evolution of toilets in the history and what is its current state?

Through the study, the answers of the following questions will also be analyzed.

- How did toilets evolve in history?
- Which factors have effected toilet designs throughout history?
- What is the current situation of squat and flushed toilet usage in the world?
- What are the advantages and disadvantages of squat and flushed toilets?

1.3 Significance of the Study and the Structure of the Thesis

There are very few studies focusing on toilets in the literature. On the other hand, although there are several studies related with the toilets in general means, they do not provide information on the relationship between the toilet design stages and the historical development of the ways of dispose human waste. In order to examine this relationship, the evolution of the toilet design is explored; the literature related with the archeological findings about toilets is reviewed to discover how early civilizations developed different ways to dispose of human waste. In the light of this review, a timetable of the toilet design is created. Moreover, types of squat toilets identified by historical data were modeled and categorized in a table in order to provide an overview of the squat toilet examples in the history. This would help sanitary ware designers to toilets more knowingly. Advantages and disadvantages of toilet designs are tabulated in a table.

It is evident from the existence of different types of toilets all around the world that there is a relationship between cleaning habits, cultural differences and beliefs of people with designs of their toilets. Literature review also shows the differences between the toilets from different regions of the world and discusses the possible factors of those differences.

The rest of the thesis is organized as follows. Chapter 2 describes the history of flushed and squat toilets and continues with emphasis on disadvantages and advantages of toilet types. The thesis is concluded with Chapter 3 by summarizing the results of the literature review and discussing the factors affecting both flushed and squat toilet designs, and current state of the toilets in Turkey and the world.

CHAPTER 2

LITERATURE REVIEW

One of the purposes of literature review is to investigate the methods and products used to dispose of human waste throughout the history, and understand the fundamental factors for differences in toilets. In order to understand the evolution of toilet designs, particularly flushed and squat toilets, throughout the history, the literature review was carried in three-fold. It began with the investigation of the articles on the findings of archeological studies to uncover the history of toilets in Ancient and Middle Ages.

Secondly, journal articles, books, and dissertations were reviewed for comparative studies on flushed and squat toilets to investigate their advantages and disadvantages. The history of Turkish ceramic sanitary ware production is also explored by means of toilet designs, and the current status of toilets and squat toilets, as eco-friendly sustainable alternative to flushed toilets. Finally, as a complementary part, a patent search was conducted to investigate attempts to develop squat toilets or to combine them with flushed toilets. The information gathered from these sources was organized in a chronological order within each section.

Toilet design, squat toilets, flushed toilets, sanitary ware, and toilet ware were the main keywords throughout the literature search.

Main databases searched for this study are; Academic Search Complete (for the period between 1950-2008), Blackwell Synergy (1950-2008), Cambridge Journals Online (1950-2008), Science Direct Journals (1950-2008), Dissertations and Theses (1950-2008), Encyclopedia Britannica Online (1950-2008), Google Scholar (1950-2008), METU Library (1950-2008), Bilkent Library (1950-2008).

2.1 Evolution of Toilets Throughout the History

Throughout the history, toilet has been an important part of human life. Toilets vary from one land to the other from one century to the other. Many are used for hygiene now but in ancient Roman public toilets were where people socialized as well. Archaeological excavations surfaced a lot of evidence on ancient cleaning habits and also on toilets. Slowly, after the invention of toilets, people built sewer, drainage systems, and water channels to dispose of the waste and increase hygiene. In this section, the evolution of the toilets based on the historical facts and discoveries in archeological excavations is described.

Throughout the history many civilizations find ways to dispose of human waste. All these civilizations developed different methods. Cultural differences, beliefs, necessities, hygiene shaped the toilet design. Thus, there have been many different types of toilets around the world including flushed toilets and squat toilets. While the squat toilets were discovered and have been used in Asia, Middle East and Africa, and some of the places in the Europe such as Greece and Italy, flushed toilets were discovered in Western countries. Three widely used toilet types today are as follows (Kafalı, 2005) (Figure 2.1):

1. Flushed: The user sits on the seat.
2. Squat: The user puts his feet on the rests and squats.
3. Urinal: The user stands and faces to the toilet.

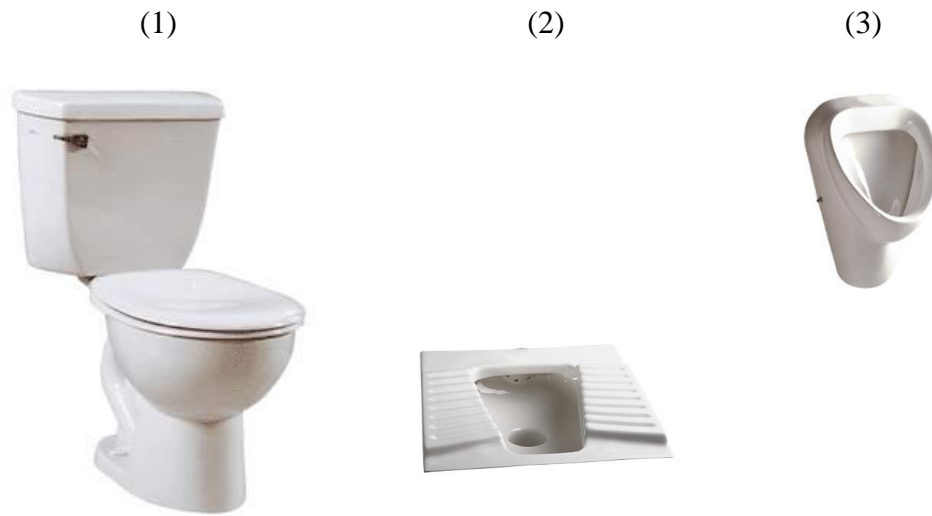

Figure 2.1 Flushed, (2) Squat and (3) Urinal toilets.

(VitrA Bathroom Culture, (n.d.))

The evolution of flushed toilets in the history of the world is discussed in detail in the next section.

2.1.1 History of Flushed Toilets

Flushed toilet designs have changed significantly throughout the history. In Ancient Times during Romans, the development and usage of flushed toilets reached their peak, and followed by a downfall during Middle Ages because of reduced attention given to hygiene. However, the awakening of Europe after the Middle Ages with growing enlightenment opened the doors for rising of a new age in toilet design. This rise continued in 1500s to 1700s with improvements that led to the design of modern toilets.

2.1.1.1 Ancient Times

The toilet was a significant part of the ancient sanitation habits as in modern times. Information on ancient sanitation may help to understand modern toilet designs because of the different life styles, religions, behaviors and beliefs; toilet design shows diversity throughout the history. For understanding the stages of the evolution of toilet design, information on sanitation and plumbing systems and hygiene habits is necessary. Thus, in this section the findings of archeological excavations in different areas will be explored in order to explore the changes and developments in the history.

Findings of archeological excavations revealed that the beginning of the sanitation dates back to the ancient times. According to some historians, the sanitation remains found in Orkney Islands in Scotland dating back to 8000 BC are the oldest ones discovered so far. There were bathrooms in Orkney homes that had plumbing pipes that were connected to the outside pipes (Eagan & Gruber, 2008).

It was also during ancient times that the toilets evolved from simple pots used by early residence of Mesopotamia, Greece, Egypt, and many other lands to a more complex structures. The early toilets were first seen in Mesopotamia and Indus valley. The ones in Mesopotamia were built in the middle of 3000 BC by the King of Akkad, Sargon I, who was known with his Palace Knossos, a well-known building with its architectural features and its flushed toilets (Wright, 1960; Horan, 1997).

There were six privies in King Akkad's Palace that provides evidence on the importance given to cleanliness and hygiene. Privies were toilets where the user sits. They were shaped like a keyhole and the waste was drained into a portable pot under the sitting plate (Gülbay, 2003; Cooper, 2001; Jansen, 1989). Building these toilets and getting rid of the waste required minimal effort. Personal cleanliness was important for Mesopotamians. They used water to clean themselves (Horan, 1997).

In addition to the privies in Palace Knossos, there were earthen pots, and a squat-pan that is a toilet again but requires squatting position to use.

At Babylonia, another Mesopotamia civilization which was located in today's Baghdad, people built *latrines* with terracotta pipes that were connected to the cesspools (Cooper, 2001) so that the human waste could be disposed of with no human effort.

The toilets in the houses in Babylonia were more primitive compared to the ones found in Palace Knossos. There were holes on the ground where people squatted, and the waste dropped into a cesspool which was located under the holes. Size of the cesspools differed according to room size. The pipes that carried human waste from houses to cesspools were made of clay. Historians dated these toilets back to about 4000BC (Schladweiler, 2002).

The materials that were used to collect and carry the human waste were important in sanitation history because the pipes must be strong enough to carry the human waste. In addition, materials used to make toilet seats differed based on the socio-economic status of their users. Poor families and slaves had clay toilet seats that were close to the ground. On the other hand, rich people had decorated wooden seats that were higher than the toilets of poor people and slaves ("The ancient city Babylon," 2008).

It's worth to be mentioned here that the toilets and bathrooms were designed separately in Babylon. According to the written records found in Iraq where ancient civilization of in Babylon was located, there were no toilet bowls in the bathrooms as we have today. This is because the bathroom was considered as a hygienic facility where people cleaned themselves and purified. On the other hand, toilet room was considered *dirty* ("The ancient city Babylon," 2008).

Similar to Babylonia, the city of Mohenjo-Daro in Indus Valley, which was located in today's Pakistan, had *latrines* and cesspools that were connected to the drainage

systems and toilets (Gülbay, 2003; Jansen, 1989; Cooper, 2001). Moreover, there were wooden panels at the end of the copper pipes. Some of the bathrooms were located in the second floor. They built the latrines, which placed in first floor, next to each other to combine the pipes easily (Schladweiler, 2002). A remnant of a toilet discovered in the city of Mohenjo-Daro in Indus Valley is shown in Figure 2.2 (Gülbay, 2003; Jansen, 1989; Cooper, 2001).



Figure 2.2 Toilet and Bathing Area in Mohenjo-Daro in Indus Valley

(“Toilet Timeline,” 2008).

People of the city Mohenjo-Daro in Indus Valley discharged the sewage from the toilets and bathrooms through the canals built underneath their houses but they did not cover the drainage holes in the streets to avoid the odor emitted from the canals. They established public baths in the town centers and placed toilets attached to the

outer face of the bath-walls. These toilets had wooden or stone seats and the sewage was run into the canals in the streets (Horan, 1997).

According to a scientific investigation of remnants found in excavations in Egypt, the scientists claim that Egyptian women, used to clean their whole body after using toilets. There were findings from 2500 BC that there were bathrooms with water cups to wash hands. These are evidences of the importance given to personal cleanliness and hygiene (“Toilet system near,” 2008).

Ancient civilizations in Egypt were good at science and many other things such as architecture and drainage construction. Egyptians were able to build drainage systems similar to the ones in Babylonia and Mohenjo-Daro. However, the material used was different. The Egyptians used copper pipes instead of terracotta.

Excavations in the mortuary temple of King Sahure at Abu Sir in Egypt from around 2500 BC revealed portable toilet facilities with metal fittings mounted on niches in the wall. There were copper pipes placed under the basins to drain the sewage out of the temple and on to the sandy soil (Gülbay, 2003). In fact, there were two ways to dispose of the human waste in ancient Egypt. One of them, as mentioned before, was to throw the human waste on the desert with the assumption that the sunlight would evaporate or the sand would cover the waste. The second one was to convert the human waste to fertilizer.

A toilet with limestone seat, built inside the bathroom toilet of a house that belonged to a high-ranking official, was found in Tell-el-Amarna, Egypt (Wright, 1960). It was similar to today’s flushed toilets without the “jet flush”, high speed water flow (Gülbay, 2003; Wenz-Gahler, 2005; Wright, 1960) (Figure 2.3).



Figure 2.3 Stone Bench or Limestone from the Ancient Egypt
(“The Science & Society Picture Library,” 2008).

In Ancient Egypt, cultural values and beliefs were among the factors that gave form to toilets, such as the toilet and bath facilities in the Pyramids of Egypt. The Egyptians, according to historians, believe afterlife and they built many things, including toilets, to make life easy in their second journey (George, 2001).

Another example of cultural influences on toilet design was seen in ancient China. A flushed toilet with armrests and a fixed lid was discovered in an ancient prince’s tomb from Western Han Dynasty (200 BC to 24 AD) (Wenz-Gahler, 2005). According to the archeologists, putting a toilet in a tomb was an evidence of the importance of how Chinese give pay attention to life after death. They want to live comfortable in after death like Egyptians (Bellis, 2005).

One of the ancient Greek civilizations, located in Crete Island, also had advanced sanitation systems. Archeologists discovered toilets in Crete from 2000 BC; the oldest known flushed toilets that used rainwater, similar to the today’s flushed toilets. Archeologists also discovered wooden and stone toilet seats in this region from the same period. The toilets at King Minos’s Royal Palace at Knossos had wooden seats and flushing conduits as shown in the Figures 2.4 and 2.5 and the toilet found near

the Palace of Mallia in Crete had a stone seat (Angelakis et al., 2005). Additionally, sophisticated drainage systems were discovered at Knossos from 1700 BC. The terracotta pipes with joints sealed with cement, drained the water and human waste out of the palace and in to the nearby river Kairatos.

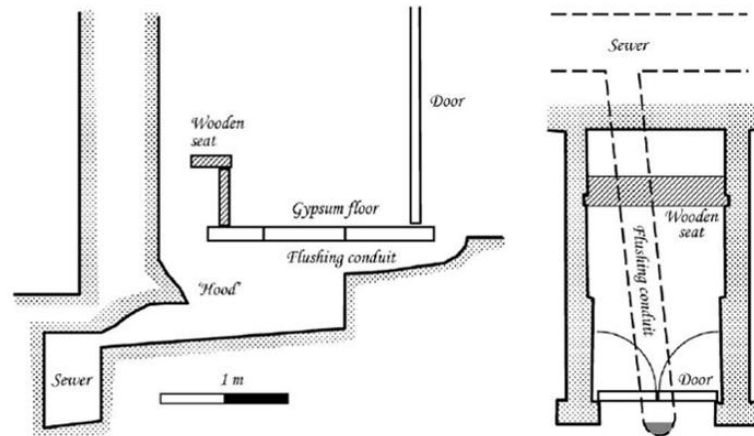

Figure 2.4 Section and Plan of Ground-floor Toilet

at King Minos's Royal Palace in Knossos (Angelakis et al., 2005).

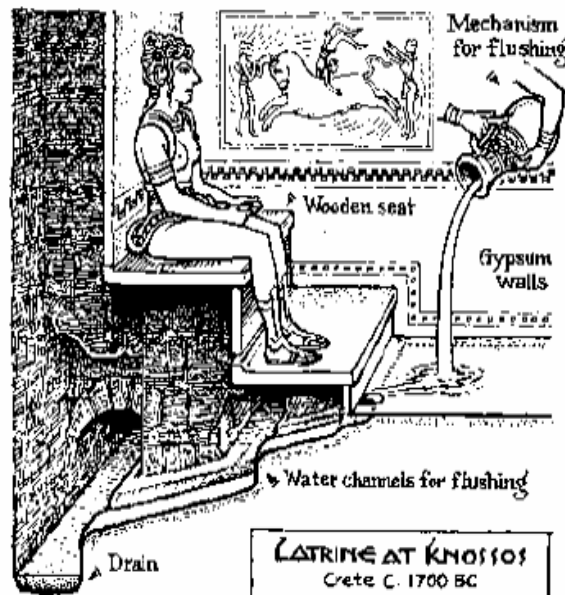

Figure 2.5 Latrines at Knossos Crete 1700 BC (Brinkerhoff, 2007).

It is noteworthy that, cisterns, reservoirs for storing liquid, and aqueducts, a conduit for carrying large amount flowing water (Merriam-Webster's Collegiate Dictionary, 1993), carried rainwater to the Knossos Palace. Excess water was stored for the case of less rainfall (Cooper, 2001). In the absence of rainwater, the user or the servant could pour water through a hole outside of the lavatory (Angelakis et al., 2005). It is apparent from the complex design of the drainage system and improvements in the cleaning of the toilets that the people of Crete highly regarded hygiene and well-built cleaning habits. Toilets found in Palaces of Mallia and Knossos in Crete had structures that support sitting rather than standing or squatting (Graham, 1962).

Archaeologists found anatomically-shaped earthen seat in Olynthus in today's Greece, which dates back from 5th century BC. According to researchers these seats were used over cesspits or some other mechanism for collection of waste. However the lavatories with stone toilet seats appeared around 4th century BC, archaeologists found lavatories in the public buildings at Delos in today's Greece and an on floor earthen utensil with clay sewerage from this period. Many well-preserved lavatories were discovered in houses at Delos, Thare, Amorgos, Dystos, Kassope, and Erythrae, all located in today's Greece. The evolution of layout of lavatories developed by Greeks was parallel to the developments in water and canal construction and management. The features of the mature form of lavatory from late Hellenistic period were passed on to the Roman Empire. According to excavations, there were private and public lavatories that have wooden or stone bench type seats. Benches shaped were similar to a keyhole (Figure 2.6). The lavatories were placed at rooms adjacent to the street along which lied the sewage drainage ditches. The private lavatories were used by up to three individuals at a time and public ones up to 10. Contrary to the today's toilets there were no partitions between the lavatories, hence, there were no privacy concerns (Antoniou, 2007).

Lastly about the Ancient Greeks (300 BC to 500 AD), they took a different approach from other civilizations in dealing with the waste and wastewater. They used

wastewater for irrigation and to fertilize crops and orchards (Cooper, 2001) instead of getting rid of it.

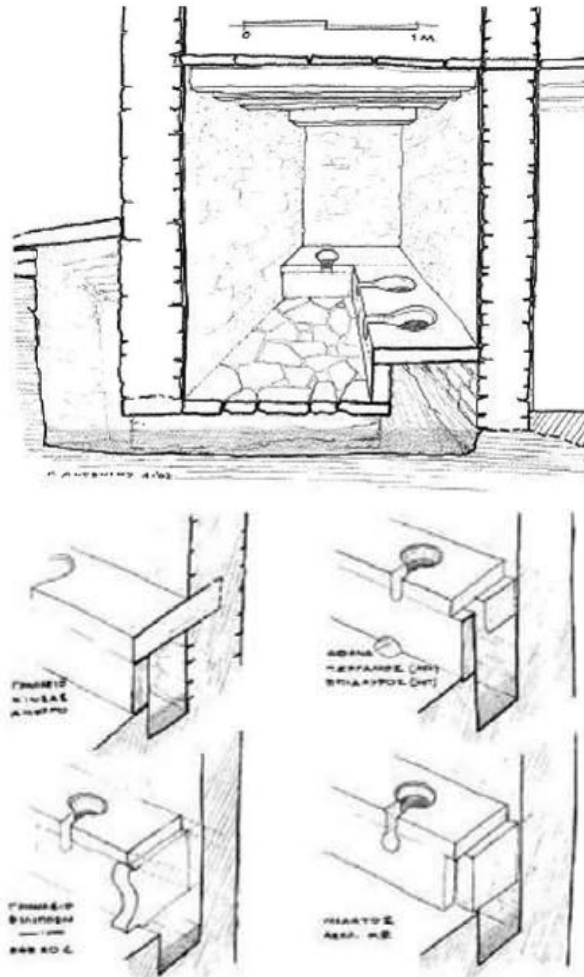

Figure 2.6 Lavatory and Types of Lavatory’s Seats in Ancient Greeks

(Antoniou, 2007).

Latrines were one of the interesting and advanced structures in ancient Rome, the most famous civilization in the history with its architectural structures. In 800 BC, many Roman houses had toilets and sewer system that was collected to a grant drainage structure Cloaca Maxima. (Cooper, 2001; Wenz-Gahler, 2005). It was built

as an open-air canal in 6th century BC to carry fresh water from streams to an open area, which was called Forum Romanum during the reign of the Roman Empire. Initially, Cloaca Maxima spanned 100 meters through Forum Romanum. However, the growth of the city population raised the need for improvements in the drainage system for better hygiene (Chanson, 2008). Ancient engineers and developers of this period, supported by wealthy politicians, worked together in maintaining and expanding Cloaca Maxima to overcome the challenges in increasing the hygiene in growing cities. Agrippa, a Roman statesman and general in 1st century BC, financed the repairs to the Aqua Marcia, which was a water-supply cut off from the drainage system (Cassius, 1995). The outfalls of the Roman aqueducts fed the Cloaca Maxima to help remove the waste with a continuous flow of water in to the River Tiber (Chanson, 2008; Hopkins, 2007). Despite the complex network of pipes connected to the Cloaca Maxima, it seemed to drain sewer from only public toilets and bathrooms. There were few Roman private residences that had the facilities to lead the sewage to the drainage system. Alternatives to the Cloaca Maxima included cesspits, ditches, covered aborts, and chamber pots (Chanson, 2008).

In Rome, house latrines were placed in the kitchens, and they resembled garbage disposals. According to excavation findings, those latrines generally were built for one person. However, archaeologists confirmed the existence of latrines that were built for eight people. All of the latrines had wooden toilet seats. There was a hole in the bottom where the waste fell. The toilet could be flushed by pouring water into the opening in the front, and cleaned with tools as shown in Figures 2.7 and 2.8. (Gülbay, 2003).

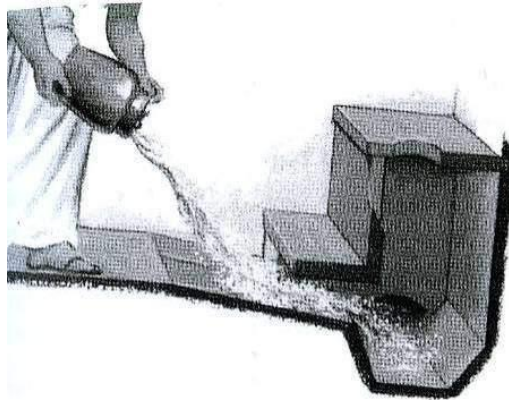

Figure 2.7 Garbage Toilet Disposal (Connolly and Dodge, 1998).

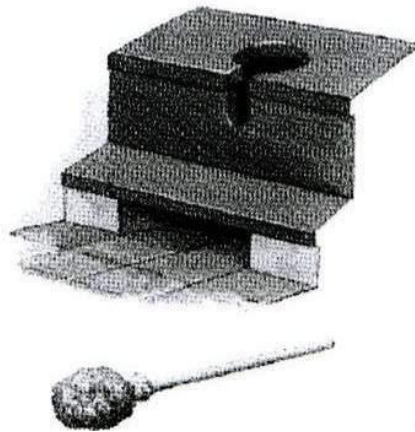

Figure 2.8 Toilet Cleaning Tool: Stick With a Sponge at the End (Connolly and Dodge, 1998).

Historical records show that *public* Rome latrines had no panels separating the toilets from each other (Figures 2.9 and 2.10) (Gülbay, 2003). This was because of Romans' thoughts about the toilets that they were a good place to *relax and socialize* (Figure 2.11). After 100 A. D., although the system was connected to many houses; some of the Romans were using public latrines (Cooper, 2001) (Wenz-Gahler, 2005).

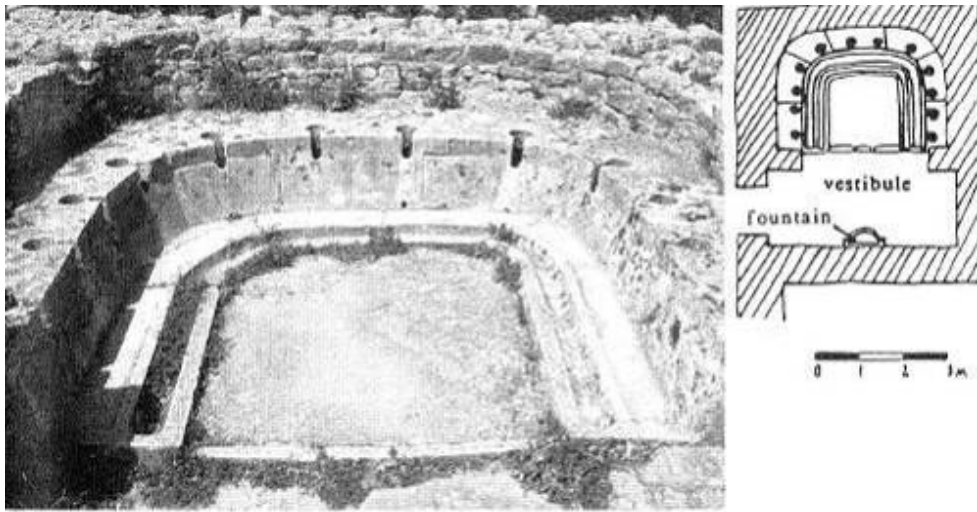

Figure 2.9 Roman Latrine in Dougga, Located in Today's Tunisia (Favro, 1997).

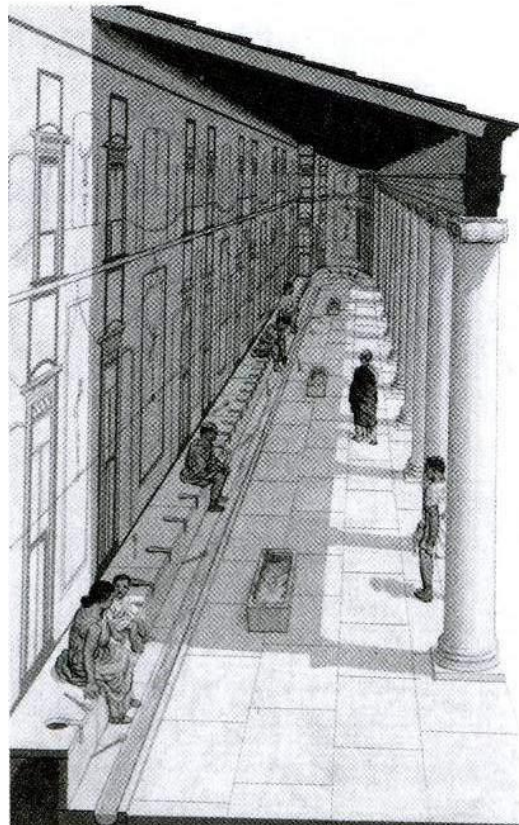

Figure 2.10 Hypothetical Reconstruction of Latrines in Rome (Connolly and Dodge, 1998).



Figure 2.11 Socialization in Toilet (Favro, 1997).

During the Hellenistic age, Romans built many architectural structures such as bridges, theaters, baths and fountains all over Anatolia. The importance given to hygiene by Romans can be seen by the number of latrines they built. Archeologists discovered only 145 latrines built during Hellenistic Age by Romans. The latrines discovered in Metropolis and Ephesos Skolastika in today's Izmir, Turkey were well-built examples of latrines in Anatolia with very complex structures (Figure 2.12) (Gülbay, 2003).

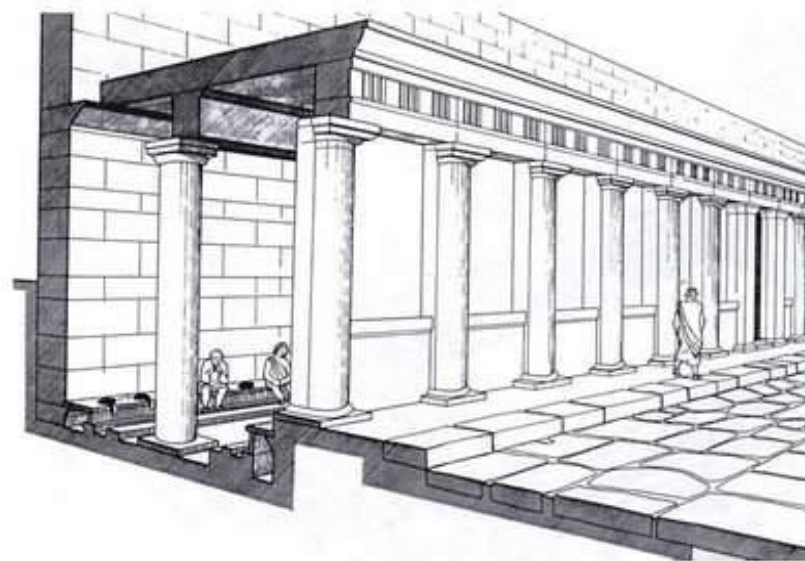

Figure 2.12 Latrina in Metropolis (Akın, 2008).

Remnants from Vikings (71 AD.) found during excavations in Europe provided evidence on their toilet habits. According to archeologists, a lot of information on people's life styles and health can be gathered from their toilet habits. It was discovered that Vikings defecated randomly around their houses, and based on chemical breakdown of the remnants, it was discovered that they suffered from poor diets that was a result of poor hygiene. That is it was very likely that their food was contaminated with human waste (Horan, 1997).

In the 200 AD Century, Germans used to dig ditches to bury human waste and garbage. In addition Germans used these cesspits to protect their valuable belongings from invaders. That is they used to store their valuable deeper in the pit, and then cover the top with garbage and human waste (Horan, 1997).

2.1.1.2 Middle Ages

According to historians, when the Roman Empire fell, it marked the end of ancient history and the middle ages began. The period from 510 to 1500 AD was called “Dark Ages” for Europe. In this period, the cleaning and toilet culture brought by Greek and Romans were discarded. It was as if the time was reversed setting people hundreds of years back in the history. The human wastes were thrown out from the windows to the streets (Figure 2.13).



Figure 2.13 A Scene From Middle Ages (Laporte, 2000).

Streets were filled up with human wastes that were thrown out of windows. In order to avoid spilling human waste on others, people were shouting “Gardy – Loo” when they opened the window to get rid of the contents.

Materials of toilet pots were determined according to the status of the people. The toilet pots designed for rich people were made of precious metals such as silver

while the ones designed for poor people were made of less precious materials such as terra-cotta and copper. The chamber pot of James I, King of Scotland was made of silver as shown in Figure 2.14.



Figure 2.14 A Silver Chamber Pot (Mattelaer, 1999).

During the Middle Ages, hygiene was ignored. It was easy to use pots and to throw the waste out of the window instead of building toilets invented by ancient civilizations or improve the previous designs. Between 1348 and 1350 there were lots of deaths caused by illnesses (as opposed to wars), especially Black Death (Bubonic Plague). Black Death was an infectious disease that was spread around by animals moving on streets covered with filth from human waste thrown out of windows (Horan, 1997).

The designers were focused mainly on the decoration of chamber pots that were made from different materials such as earthen ware, tin, etc. With the discovery of Chinese porcelain people used porcelain for the material that helped them to create decorative chamber pots (Horan, 1997).

Later in the Middle Ages, people started to hide their chamber pots inside close stools which were commonly used in 17th century. Close stools' materials were wood that enabled user to sit instead of squat (Horan, 1997). So it was easier to use this type of toilets, and then someone (e.g. maid) disposed of the waste. The close stools that looked like chests are the implication that they were built to resemble furniture so that guests of the house did not realize that they were actually toilets. This is an implication of increasing importance of privacy in the utilization of toilets.

Historical evidences show that in the evolution of toilet design, material became an important element. The close stools of Middle Ages were made of wood decorated with gold and silver. The seat was made of soft and durable fabrics such as velvet to provide comfort to the user. Chamber pots were started to be made of porcelain material because it was easy to clean and provided more hygienic products. Elizabethan's chamber pot was an example of ancient pots which was made of terra cota (Figure 2.15). Factors, affecting design, were customization through material and decorations and esthetical aspects (Horan, 1997).



Figure 2.15 Elizabethan Chamber Pot (Humphreys, (n.d.)).

An alternative to the chamber pots was “garderobe” that was a small private toilet built into castle walls starting in 1189 in London (Figure 2.16). They had stone or wooden seats (Figure 2.17). Some of the garderobes were built for two or three people. The number of toilets which were placed in garderobes changed according to family member numbers (Figure 2.18). The waste was led outside of the building through pipes (Wright, 1960; Wenz-Gahler, 2005). These toilets were located near kitchen or fire places in the castle because the toilets with stone seats were very cold to sit on and in general the steam coming from the kitchen or the heat from the fire places warmed the stone seats (Horan, 1997).

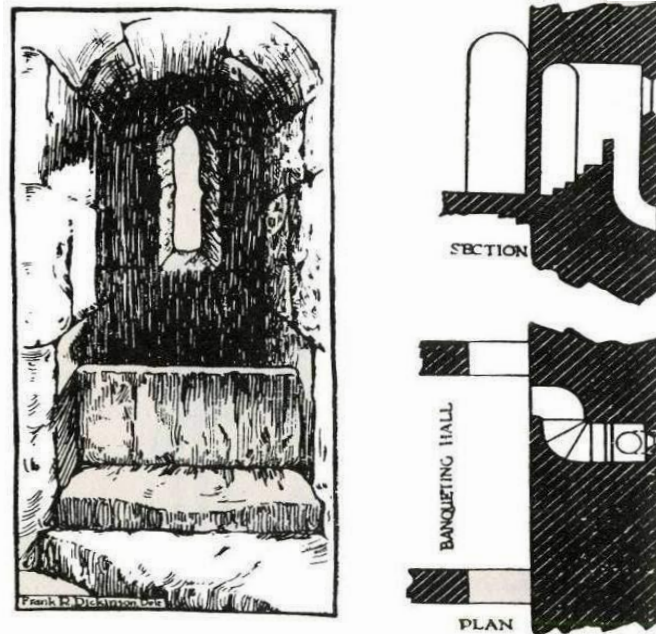

Figure 2.16 The Garderobe in Tower of London (Wright, 2005).



Figure 2.17 A Toilet in the White Tower (Churchill and Walfof, 2006).

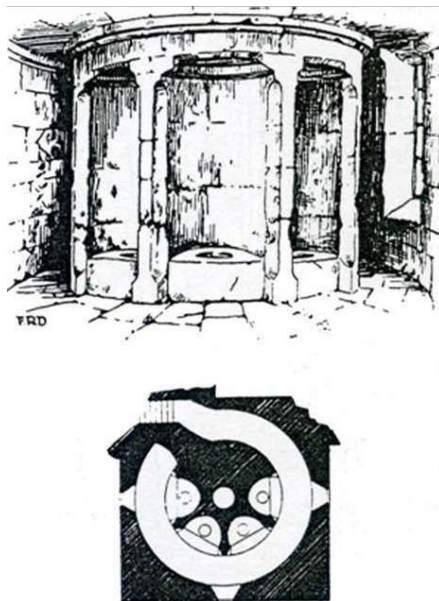

Figure 2.18 Garderobes in Southwell Palace (Wright, 1960).

It is not clear why the garderobes were not used after 1530. One reason may be that the waste collected outside of the building was not removed far to make sure that it does not create a health problem. In time, these private toilets were renovated to be used as toilets for clothes and the noun “garderobe” changed to “wardrobe (Wright, 1960; Wenz-Gahler, 2005).

The human waste was collected in cesspools and ditches in Europe around 16th century. They were very easy to build on private property or tenement buildings (Taylor, 2005). Cesspools were generally made of stone that was located one meter high from the floor (Cooper, 2001). The cleaning habits during the middle ages were very primitive compared to grand engineering wonders built Romans in the preceding period. (Geels, 2006)

One exception of Middle Ages was Leonardo Da Vinci who studied on many various projects in his life. He had several projects on flush toilets for the castle of Francis I at Ambrose. One of them had a ventilating system and flushing canals inside the walls. However, it was not built because the existence of this design was unknown (Wright, 1960).

While in the period of Rome, there did not exist an understanding of shame or privacy, now people started to be ashamed and designs were implemented in order to decrease that shame. After that also musical equipment was added to the toilet table or close stools. Music started with the opening of cover to avoid the sound of relieving their selves.

2.1.2 History of Squat Toilets

2.1.2.1 World

In Section 2.1.1, the evolution of flushed toilets in Ancient Times and Middle Ages, around the world was presented. In this section, the history of squatting toilets with emphasis on the ones that resemble squat toilets is considered. Various names have been used for squat toilets: Turkish style, squatting pan, and squatting plate. Squat toilets have been used in many places such as India, Japan, China, and Anatolia since Ancient Times.

The most known examples of ancient Indian toilets today was the ones that were built by Harrapan civilization from 2500 BC. These resembled flushed toilets rather than squat toilets, and they had advanced plumbing systems to dispose of the waste. However, over the years Indians started using squat toilets and many Indians refer to these toilets as “Indian water toilet” (Mara, 1985).

Indians reused the human waste collected in a pot under their squat toilets. This collection pot is the only difference between Turkish squat toilets and “Indian water toilet”. These waste collected in these pots were processed into fertilizers (Winblad et al., 1978).

The main disadvantage of the Indian water toilets was their poor sanitation. That is why there are also referred to as poor latrines. (Mara, 1985)

Another country where squat toilets have been used is Japan. Their squat toilet history goes far back. Japanese squat toilets are known as traditional toilets and are similar to Turkish squat toilets. The main difference between the Japanese style toilets and Turkish style toilets is that the Japanese one has handles, made of wood that the user of the toilet can hold on to while squatting. This prevents people from falling in the toilet in squatting position (“The History of Toilets,” (n.d.)).

In addition to contemporary squat toilets, ancient ones and cesspits nearby the toilets were also discovered during excavations in Fujiwara Palace in Nara, Japan. An image from excavation site and illustration of the discovered toilets are shown in Figure 2.19 (“The History of Toilets,” (n.d.)).

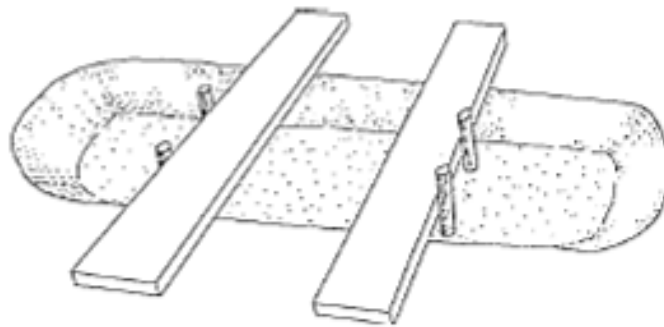

Figure 2.19 Fujiwara Toilet in Japan (Matsui et al., 2003).

Sewage and drainage systems were also discovered during excavations in Nara, Japan from various periods and Osaka Castle in Osaka, Japan (Matsui et al., 2003)

Ancient ruin of flush toilets has also been found out in the tomb of a king of the Western Han Dynasty in China (206 BC to 24 AD). However, in addition to flushed toilets, squat toilets were also discovered, and commonly used in contemporary China. In rural parts of Shanghai, China, it is not uncommon to observe staff carrying waste pots with batons. Chinese squatting toilets were easily built by digging a hole

and placing two timbers on top. (Pekşen, 1998). Squat toilets are not as primitive as the rural ones in the urban areas, and they vary from one location to the other within the country. For example, Tibetan squat toilet shown in Figure 2.20 is different than the contemporary ones in China. The Tibetan squat toilets are in general made of wood (“Toilet with a great,” 2008)



Figure 2.20 Traditional Tibetan Toilet in the Potala Palace in Lhasa, China.

(“Toilet with a great,”2008).

2.1.2.2 Anatolia

More than 90% of the land of Turkey is located in Anatolia. Many civilizations lived in Anatolia throughout the history. Some of the first known settlers of Anatolia are

Hittites, Frigs, Lidians, Ions, between 2000 B. C and 600 B. C. Later, Anatolia was invaded and ruled by Romans, Byzantines, Seljuk's and Ottomans.

Remnants from Frigia civilization were discovered in Ayazini Valley (located in Afyon, Turkey) during excavations. One of the remnants was a squat toilet found in a house made of rock, and the hole located at the bottom of the squat toilet opened to a pipe through which the human waste flowed outside of the house (Türker, 2002).

In 2004, archeologists discovered remnants of toilet and sewerage systems from prehistoric times (1200-600 BC) in an Urartian castle in Gürpınar region of eastern Turkey. According to Prof. Dr. Oktay Belli, İstanbul University Eurasian Archaeology Institute Director, the toilet is similar to today's squat toilets ("World's oldest sewer system," (n.d.). At the excavations, in Üzümlü, Erzurum, remnants of a lavatory, bath, and squat toilet were found in 2007 (Torunlar, 2007) (Figure 2.21).



Figure 2.21 The Toilet in Erzincan Üzümlü ("The Toilet in Erzincan," 2007).

It is hypothesized that the designs of squat toilets in Anatolia were brought from Syria, and that they were widely used in Anatolia. Later, Ottomans introduced squat

toilet to Europe in 19th century as “alla Turca” in Italian where flushed sitting type toilets were referred to as “alla Franca” (Aytaç, 2004).

In Ottoman period, the toilet generally was located outside of the house. This may be because having human waste in the house was a sign of being filthy, especially when hygiene was seen as part of being a good Muslim living in Ottoman Empire (Gürel, 2008). However, later with the developments in architecture and improved drainage and sewage systems, the toilets were placed in houses, specifically, in a division called “eyvan”. *Eyvan* was one of the rooms in Turkish Baths (Aytaç, 2004). The toilets located in the garden generally had one hole at the bottom that is they were for one person only as opposed to ancient toilets in Roman times. The toilet was aired through a pipe or a small hole that opened to outside. The materials the toilets were made of varied. Some toilets were made of wood while some were made of marble (Aytaç, 2004).

Ottomans also had public squat toilets that were co-located with *abdesthane*. These places had water for people to clean themselves but not for taking bath. Squat toilets were separated from each other in the public toilets to allow only one person in each division. Examples of these toilets can be seen in Kütahya Saadettin Cami (Mosque) and Ulu Cami (Mosque) from Ottoman Period (Türker, 2002).

The origins of Ottomans are in Northeast Asia. The concept of bathroom shaped during the Ottomans had the effect of both Islam and their origins that was quite different than the bathroom concept of Romans who occupied Anatolia and left many architectural structures such as bath houses. That is the occupiers of the land affected the bathroom concept in Anatolia. Ottoman bathrooms (houses) had squat toilets while Romans did not have toilets in bathrooms. On the other hand, Ottomans used the existing sewerage systems, specifically the ones originally developed by Hittites. These sewerage systems were called “algun” during the period of Ottoman Empire (Aytaç, 2004).

Archeologists discovered remnants of squat toilets built during the period of Crusades and Ottoman Empire in Bodrum, Turkey. The most significant thing about these toilets found in Bodrum, Turkey, was that they were nicely decorated with ornaments. The remnants of these squat toilets are shown in (Figure 2.22). Two squat toilets, located side-by-side, were found in Castle of Saint Peter at Halicarnassus in Bodrum, Turkey. The toilets were separated by a wall to provide privacy (“Toilets around,” (n.d.)).



Figure 2.22 Ottoman Toilets in Bodrum Museum (“Toilets around,” (n.d.)).

There were also old style squat toilets found in Safranbolu houses in Turkey. It is not very-well investigated from which period these toilets were. These squat toilets were made of wood and they were shaped like a large key-hole. The toilets were located either on first or second floor (but not on third floor) (Aytaç, 2004). The old style squat toilets found in Safranbolu houses have backs to prevent human waste from spilling around. These types of squat toilets are called front part “alınlıklı” that will be discussed at the end of this section. The toilets had footrests as shown in Table 2.1.

The common characteristic of the Turkish squat toilets was that they were squatting toilets. There were minor changes in the form based on location in Anatolia. An example of a squat toilet from Ottoman period located in Harem in Topkapı Palace is shown in Figure 2.23. The key-hole shaped structure is located in the middle of the toilet space. The toilet was made of marble. The reason for using marble was that it was easy to clean, hence, more hygienic compared to metal or wooded toilets. The distance between the holes of the key-hole shaped part is distant enough from the wall so that the body of the user does not touch the wall. On the other hand, the wall was carved to have a convex shape to prevent spilling of human waste. The toilet does not have flushing system but the human waste was removed from the toilet via pipes located under the key-hole shaped part. There is a hole located on the roof to remove the bad smells and air the toilet (Pekşen, 1998) (Figure 2.24).



Figure 2.23 Toilet from Topkapı Palace (“Toilets around,” (n.d.)).



Figure 2.24 The Castle of Saint Peter at Halicarnassus (“Toilets around,” (n.d.)).

There are also two different types of squat toilets, which are built from wood, are placed in Safranbolu Houses. One of them shape resembles letter V (Figure 2.25), and the other resembles a keyhole (Figure 2.26). According to Islamic culture, cleanliness is important. Thus, in the toilets there are cups which are used for cleaning the body after using the toilet (Günay, 1998).

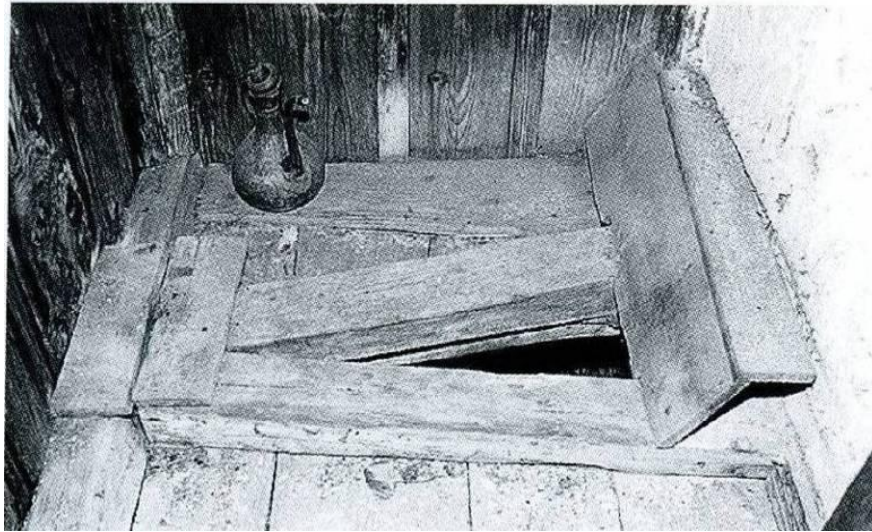

Figure 2.25 “V” Type Toilets in Safranbolu Houses (Günay, 1998).

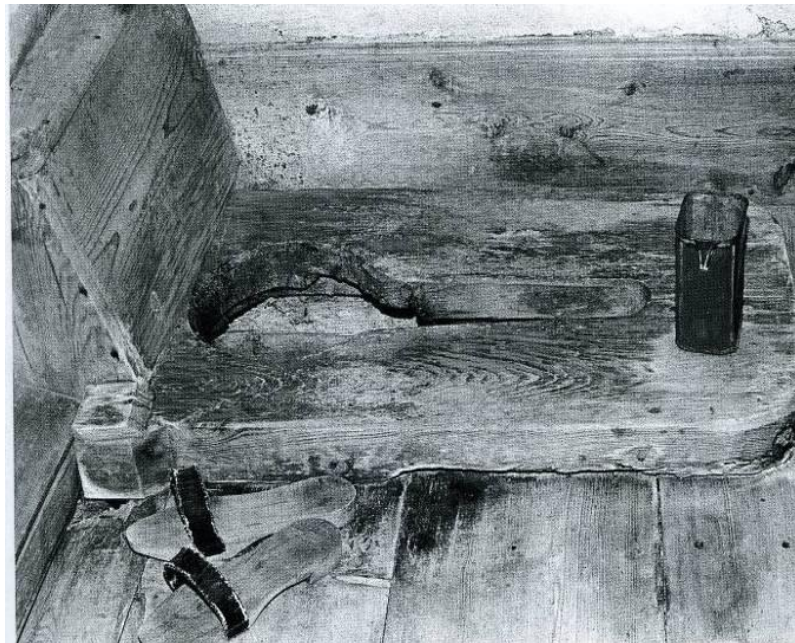
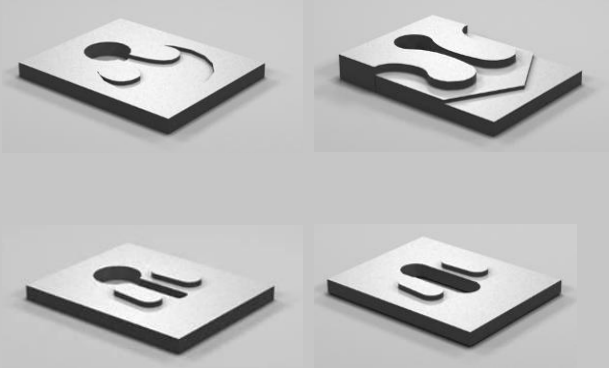
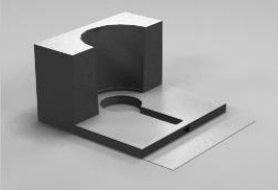
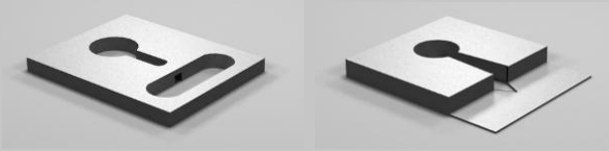



Figure 2.26 An Example of Squat Toilets in Safranbolu Houses (Günay, 1998).

There were several types of squat toilets based on the existence and shape of three major components: Foot rest, front part, and hole (Pekşen, 1998).

Table 2.1 Table of Basic Turkish Squat Toilet Types

	Alınlıklı [with front part]	Alınlıksız [without front part]
Basamaklı [with foot rest]		
Basamaksız [without foot rest]		
V type		

2.1.3 Toilets in 1500s to 2000s

There were many developments in toilet design starting from 1500s. However, the design and development of toilets were not taken seriously until 18th century. In 18th century a group of inventors with various backgrounds such as carpenters and

watchmakers in Europe started working on developing toilets initially for private use and then later for public use.

During this period, first toilet designs focused on the functionality. Once the basic functionality had been achieved by the end of the 18th century, the designers focused on improving the hygiene starting in early 19th century. The most important development in increasing the sanitation was the transition from iron workings to ceramics. The second was the invention and wide use of siphon system. The increased emphasis on sanitation through government regulations resulted in significant improvements in hygiene at the cost of increased usage of water in flushing toilets. Thus the improvements in the 20th century were focused on reducing the flushing water consumption. Following subsections present the important developments in toilet design through the modern times.

Pre-Victorian Period Toilets

There were many designs of toilets after 1500 and before the beginning of Victorian period in 1800. These toilet designs are identified with their designer's name. Following a list of important designs during this period.

The First Toilet 'Ajax' by John Harington

In 1596 John Harington invented a new toilet for Queen Elizabeth called water toilet. The toilet was named 'Ajax' that had many features similar to today's toilets. There were some problems like sealing-off the odors mentioned by Queen Elizabeth (Blair, 2000).

Even though the Ajax was appealing to some people in England, it was not very popular. This was because people were used to the close stools and many houses in England did not have infrastructure to support Ajax (Horan, 1997).

The factors affecting chamber pot and close stool designs were: comfort, visual aesthetics, material that varied with respect to status. In order to provide softer and comfortable seat different types of fabric were used (Figure 2.27). Decorations were used to make the design visually esthetical. Various materials were used in construction of toilets. Firstly they were produced from rock and then from timber. Later, metals were started to be used people of status (Horan, 1997).

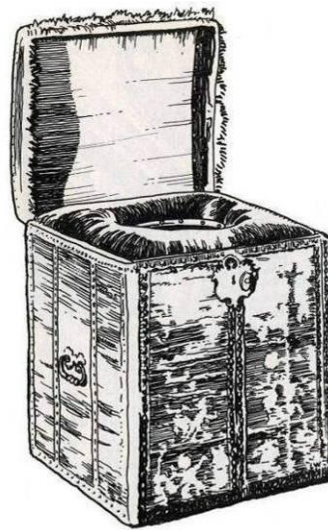

Figure 2.27 Royal Close Stool at Hampton Court (Wright, 1960).

The first immigrants to America did not have toilets at the beginning. However, the gradual establishment of farms caused the forms to start building cesspits. When cesspit was filled up with human waste, the farmers covered the pit up and fruit trees were planted on the top of the cesspit (Horan, 1997).

In 1620s, Puritans in America, who advocated personal and social purity in worship and doctrine, wanted to have their toilets resemble furniture but more esthetic than close stools, and also, the top to be used as a make-up table for women. Thus, their toilets were called toilet tables (Horan, 1997).

1700s were a transition period between Middle Ages and Victorian Period. During this period, people started to hide close stools inside cabinets in addition to hiding the chamber pot inside close stools. In 1739, due to increased privacy issues among male and female user of the toilets, males and females started using different toilets (Horan, 1997).

“S” Curve of Alexander Cumming’s Toilet Design

In 1667 the great fire in London destroyed nearly more than the half of the city. Even though it seemed like a horrifying thing, it helped to destroy the harmful animals carrying illnesses such as Black Death (Bubonic plague). London was rebuilt and this time the planners and government officials gave high priority to hygiene and cleanliness. The government during the re-building of the city mandated building a sewage system. Thus, people started to work on improving Harrington’s design which is described in the previous paragraphs.

As mentioned, one of the problems with Harrington’s design was that the odors from human waste were not sealed well enough (Blair, 2000). Two hundred years after Sir John Harrington’s toilet design, a preeminent watchmaker Alexander Cumming invented the water trap that sits under the bowl and between the toilet and sewer *blocking* the odors to diffuse into the house. Once the human waste fell through the hole, the valve got closed and the smell was trapped (Figure 2.28 and 2.29).

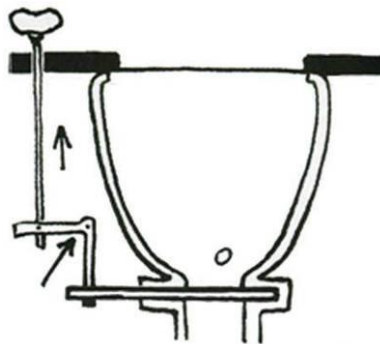

Figure 2.28 Cumming’s Metal Valve Toilet 1775 Mechanism (Blair, 2000).



Figure 2.29 Alexander Cumming's Toilet ("Toilet," (n.d.)).

Cumming's S-curved pipe, which is still used in today's toilets, helped seal the smell of human waste. Prior to Cumming, toilet builders were not able to find a solution to prevent the odor coming off the bowl (Blair, 2000).

Cumming also invented the first flush toilet in 1775. This was a major step in creating the modern toilet. However, Cumming's new toilet was not used until 1800s because cast iron and terracotta pipes were poorly built (Blair, 2000).

The form of Cumming's toilet was determined by the mechanisms that sealed off the smell and flushed the toilet with water. The S-curve and the flushed mechanisms of Cumming's toilet are illustrated in Figure 2.30 (Wright, 1960).

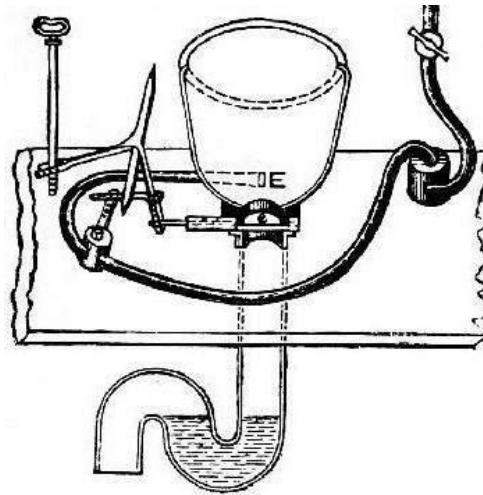

Figure 2.30 Alexander Cumming's Valve Toilet (Wright, 1960).

Plunger Toilet by Samuel Prosser

Several years after Cumming's design, Samuel Prosser invented "the plunger toilet" in 1777, at the same year with Cumming's design (Stone, 1979). Samuel Prosser invented the predecessor to the modern bullock. In Prosser's toilet design, there was a valve at the bottom of the bowl that worked on a hinge. ("The Men That Made," 1994)

The toilet bowl was made of metal and poorly designed. It was recorded that the celebrated English ceramist Josiah Wedgwood made a potter "close stool water closer pan" in 1777 for Prosser's toilet design. The switch from metal to ceramic was a crucial step in preventing flushing water spilling over and increasing hygiene (Blair 2000).

Joseh Bramah's Valve Toilet

One year later, after the Samuel Prossers design, Joseh Bramah introduced a valve toilet in 1778. Bramah was a cabinet maker, and built water toilets as well. Bramah improved the Cumming's design and get patent for his invention in 1778 (Wright, 1960). Bramah's design was very popular because of its effective outlet seal (Figure 2.31) (Blair, 2000).

Bramah's design of 1778, cover system with joints has a function of disposal. In that period it was produced by 6000 in number but because of England's not having a standardized system, it was avoided and used in elsewhere. Additionally, Bramah designed hydrolic press and lock (Horan, 1997).

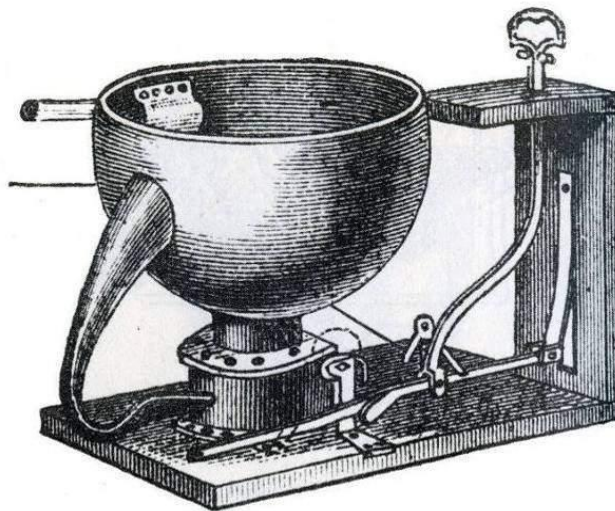

Figure 2.31 Bramah's Valve Toilet, 1778 (Wright, 1960).

There were three problems in Bramah toilet design. First, the handle did not go high enough for the water flush to work. Second, during warm days the water seal evaporated. Third, the flush was extremely noisy (Wright, 1960).

Bramah's toilets sealed off the odor coming off the bottom of the toilet bowl but because the flushing power of the water was not strong, the odor caused by the remains in the bowl was still a problem (Wright, 1960).

Victorian Period Toilets

1800-1920 Victorian Period affected toilets just like it affected any other goods. Examples of toilets from Victorian period are shown in Figure 2.32 (Blair, 2000).

Ethical issues were important in Victorian Period. Soul cleanliness was more important than body cleanliness. As a side effect of industrial revolution, communities living in U.S.A. and Britain migrated to cities where there were jobs available in these industrial businesses. Consequently, government needed to act for a healthy environment for increasing population in cities (Horan, 1997).



Figure 2.32 Victorian Toilets from a Catalogue (Blair, 2000).

In 19th century doctors were also advocating that a healthy sewage system was needed. Because they knew that many illnesses were caused by unhealthy environment (Horan, 1997).

Two important factors affecting the toilet design until Victorian Period was sealing-off the smell and washing off the waste with flushed mechanism. In Victorian Period another factor became as important as these two factors: Sound. People of Victorian Period thought that the sound of the toilet should be lower. One solution to mitigate the sound problem was to add music boxes to close stools and toilet tables. While person was in the toilet others could not hear a sound. Mechanism was too basic. When you open the cover of close stool music was starting. The main reason behind the sound problem was because people were ashamed that others would hear them when they were in the toilet and that their dignity would be lowered. Moreover, the person who was forced into listening to the sound might be offended (Horan, 1997).

In the 19th century, many toilet bowls were made of porcelain. Since it was very easy to paint figures using various colors on porcelain, the toilet bowls were decorated by paintings. The toilet seat was made of wood. Having indoor toilets were still a luxury in 19th century so several houses shared a toilet. That is why it was very common to see lines forming in front of the door for toilet (Lampert, 2008).

Early toilet toilets had very complex components that were prone to malfunctions. The design improvements were coordinated around component supplies and their assembly. Yet, sanitary improvements were implemented much later and slower. The first Public Health Act in 1848 in Britain mandated street cleaning, refuse collection, water supply, and sewerage; later acts covered drainage and sanitation (Shaw, 2003). It also mandated sanitary facilities such as water toilets and privy, toilet, (many English and Americans refer to toilet as privy even today). This comes from the noun private to be deployed in all houses. The importance of increasing sanitary

conditions became eminent after the death of millions of Europeans from cholera in 1832 (“History of the Toilet,” (n.d.)).

In the mid 1850s, changing cultural and social aspects of life made toilets taboo. This is contrary to evolution of toilet during the times of Ancient Romans who perceived toilets as a place to relax, socialize, and talk politics. As stated in previous chapters, rich people and governors in Roman Empire funded construction of public toilets that contained at least eight toilets and there were no panels between the toilet seats. Moreover, it was mentioned earlier that some Kings had chamber pots that were kept close to their thrones where everybody could see these thrones and these Kings were not ashamed of relieving themselves or defecating in front of other people. The most significant evidence of toilets becoming taboo is the attempt to cover the sounds of toilet working or person defecating (Horan, 1997; Wright, 1960).

It is claimed that the improvement of the design in that period is not only about the mechanism but also about the materials. By using ceramic materials, designers and developers provided healthier and easy-to-clean designs. In addition, since decorating and shaping ceramic was easier than wood or metal, it became easier to create custom designs. Moreover, by the invention of whole body ceramic toilets, production and adjoining operations were simplified. This provided designer to focus on customizing the design for various users.

In the 1900’s, toilets were moved into the bathrooms (Bathroom, 2008). Previously, toilets were in separate rooms. Also, people got accustomed to using toilets regularly and toilets became part of daily life. Not only the toilet, but also a number of products that contribute to the use of toilets emerge, such as toilet paper, and toilet cleaning tools.

Products such as toilet papers, toilet brushes were designed and patented. Some of these were self-cleaning products or “hand bidet” products like the one invented by Weidl in 1907 (Figure 2.33).

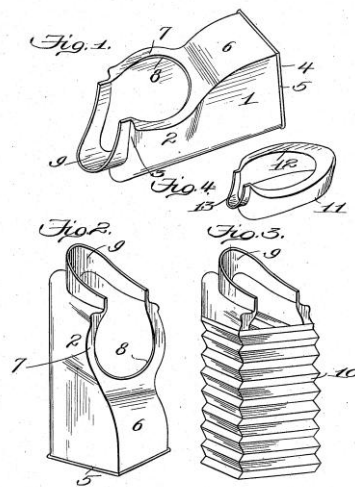

Figure 2.33 Franz Weidl Hand Bidet Design (Weidl, 1908).

Moreover, around 1912, the movement Art Nouveau affects the toilet decoration. At the beginning of 20th century, dressings and colored decorations started to become popular. Designs of Art Nouveau had elegant curves, flowerlike and flower patterns. Organic figures in dominance could also be seen in toilet designs at the beginning of 20th century (Figure 2.34).



Figure 2.34 Henry Doulton's Toilet with Art Nouveau Decoration, 1912 (Blair, 2000).

Following is an overview of important toilet designs during this period. Toilet designs are mentioned with their designers' name.

George Jennings's Monkey Toilet

In 1852, J. G. Jennings was rewarded a patent for his invention of a toilet called “monkey toilet” that had a shallow basin, dished tray, and water seal (Chun, 2002; “The Men That Made,” 1994). Jennings’s water toilet was used by the visitors in Hyde Park in Great Exhibition in London in 1851. This was the first time public toilets were used that would greatly improve sanitation (Figure 2.35).

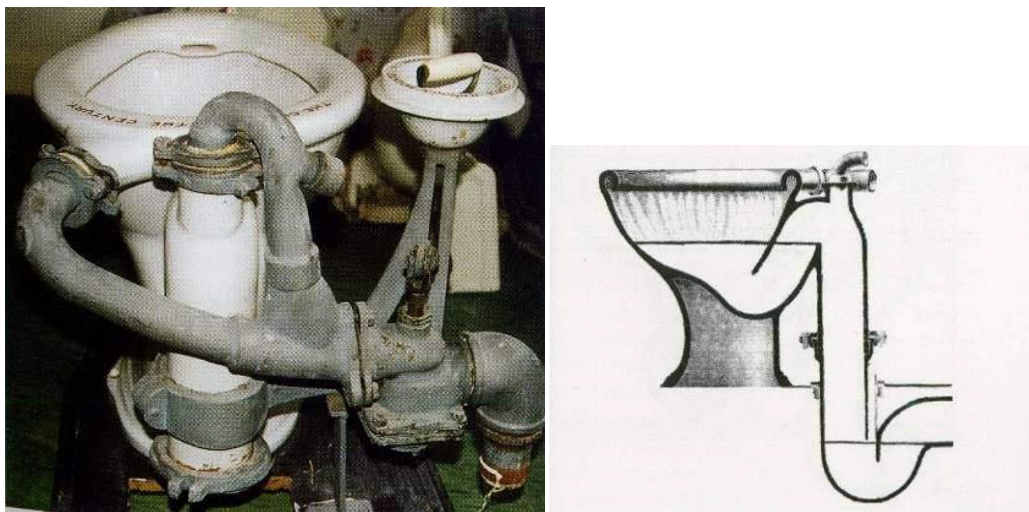

Figure 2.35 Jennings’s Syphonic Toilet (Blair, 2000).

Siphons by Thomas Crapper

In 1872 Thomas Crapper’s plumbing company started producing toilets (A&E Television Networks). The siphon discharge system replaced the problematic floating valve. Floating valves in earlier designs caused leaks. Thomas Crapper’s toilet design, “dolphin”, was exhibited in 1876 (“A History of the Embossed,” (n.d.)).

Thomas Twyford's Ceramic Toilet Designs

Thomas Twyford started to produce and replace closed cabins by ceramic because ceramic was easy to clean, light in weight, less erodible and cost-efficient. Plumbers

and sanitary engineers started to work with ceramists. Wedgwood was among the pioneers of ceramic ware production. He established a factory where he produced ceramic bowls for toilets among other ceramic ware. Ceramic bowls had many advantages in comparison to the other materials that were used in making toilet bowls (Blair, 2000).

Consequently, ceramists had a great role in producing toilets and there occurred a new sector for them (Blair, 2000). The ceramic toilet bowls varied in shape as well as decoration as seen in Figures 2.36, 2.37 and 2.38. The bowls were produced as a single body and other parts were then attached to the main body. The toilet bowl was the only ceramic part of the toilet.



Figure 2.36 Examples of Ceramic Bowls for the Twyford Toilets (Blair, 2000).

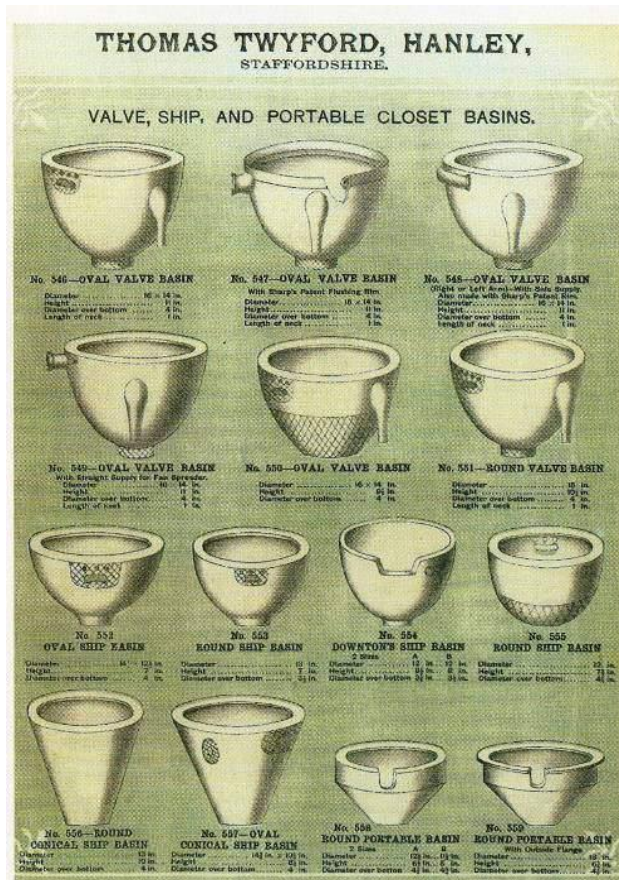

Figure 2.37 Thomas Twyford's Valve Toilet Ceramic Bowl Catalogue (Blair, 2000).



Figure 2.38 Valve Toilet With a Bowl (Blair, 2000).

Thomas Twyford revolutionized the design of water toilets in 1885. However, the toilet design up to this point failed to remove the heavier waste effectively. Later sanitary ware designers developed “jet flush”, high speed flowing water, to overcome this problem while using the current technology with minor changes. Washout toilet had very low water level such that during warm days the water evaporated. On the other hand wash down toilet had higher water levels compared to washout toilet and if the water levels got low, then it was raised (Wright, 1960).

Thomas Twyford, first designed two-piece ceramic toilet, and then one-piece ceramic toilet. The name of the toilet was “Unitas”. Those toilets were the good examples of free standing toilets. Moreover, the toilets appearance was attractive with the decorative ornaments, and this was useful in the market for differentiation from competitors (Blair, 2000) (Figure 2.39).



Figure 2.39 Two Pieces Unitas Washout (left) Toilet and One Piece Unitas Washout Toilet (right) (Blair, 2000).

J. G. Jennings, Josiah Wedgwood, Thomas Crapper, Thomas Twyford, and Henry Moule were the pioneers of the “sanitary science. While Jennings was creating a design of increasing water pressure, Thomas Crapper designed pull chain to decrease

the noise and make the water flow. Thomas Twyford cared about the esthetical aspects. He implemented mechanisms into a ceramic part. He also reshaped toilet forms and presented to public (Horan, 2000) (Figure 2.40).

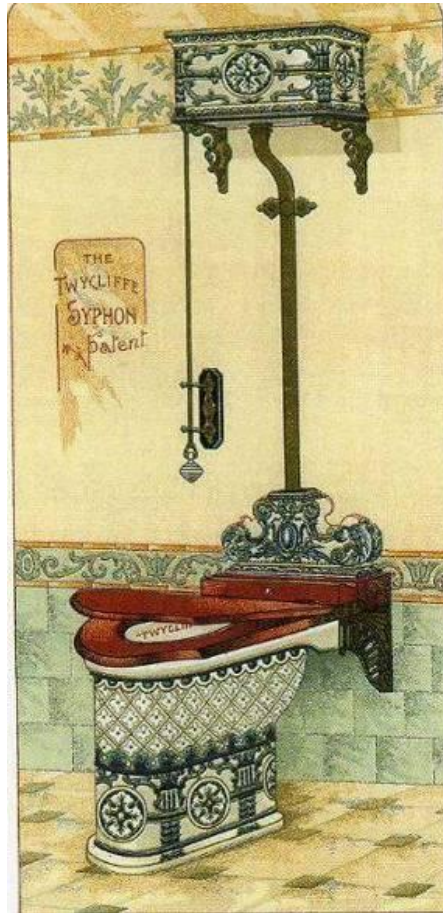

Figure 2.40 Twyford 1898 Catalogue (Blair, 2000)

Thomas Twyford's followers

After 1900, bathrooms and toilets began to spread over Europe. In 1907, Thomas Macvity invented the vortex-flushing toilet that provided the toilet bowl with self-cleaning function ("Bathroom," (n.d)).

In 1912, James H. King improved a toilet design, and got a patent for his invention under the name "sanitary toilet". In 1900s, health care was the most important

element in designs. Consequently, changes in the toilet design were geared towards meeting health care requirements. The main improvement seen in James H. King's design is the sliding trap door that prevents smell better than previous designs and it provided better hygiene (Horan, 1997).

Post-Victorian Period

1915 to 1933 was a period when changes and developments around the world affected the human life style. Especially t World War I played a crucial role in changing social life and economy (Hauffe, 1996).

Modernism began in 1918. Modernists advocated that the traditional arts were no longer in process, and their goal was to demolish traditions. History is commented as a continuous revolution to the better and perfect. (Gültekin, 2007).

Walter Gropius founded the Bauhaus school around 1919. The school's aim was to combine art and industry. Bauhaus became an important school around the world and it was a good example for the alteration (Hauffe, 1996). The importance given to design increased in parallel with the changes in social life. Day by day, the products which were used in daily life, were designed much more carefully than the past. It has affected bathroom and toilet sector too. Bauhaus movement united architect, craftsmen, and artists to create functional and artistic products not just functional.

Changes in all areas affect the life style of human lifestyle. For instance, wars and important events played a crucial role in changes of human behaviors and thoughts. (Ann and Ciesko, 2002) changed how consumers thought of products in 1920s. In many areas, new technologies and new materials were found by the researchers and scientists. The increase of the firms causes advertising valuable in market because advertising was the tool to introduce the products to the consumer. Thus, visual appearance became an important factor in selling products. Moreover, Consumers

wanted to buy more stylish and aesthetic products. Thus, day by day design became an important factor in competition in the market (Hauffe, 1996; Perks et al., 2005).

In 1920s, colored Victorian transfers, oriental patterns which were done by painting were popular. There were art deco effects in toilet designs, especially in toilet decorations. Modernist effect of art deco caused the design of toilets to have more soft lines. While users selected black and peony sanitary ware in art deco, European and North Americans were preferred pastel colors. Turquoise, lavender, primrose, blue, pink and ivory are in that kind of colors (Blair, 2000). Thomas Twyford's toilets were the good examples of 1920s toilets (Figure 2.41).



Figure 2.41 1929 Twyford's Syphonic WC (Blair, 2000).

In toilet design, earthen ware materials were common in early bowls. The color of earthen ware after the firing was white. When free standing toilets were made, stone ware material was the best for the material because of its properties (e.g., stronger than the earthen ware). Moreover, it was cheap. In 19th century cane and white ware were the main materials used in toilet designs (Figure 2.42). Vitreous China material

was introduced in 1930 and used instead of earthen ware and cane- white ware in 1950s. (Blair, 2000)



Figure 2.42 Earthen ware WC, Stone ware WC, Cane and White ware WC (Blair, 2000)

Decorations were done to make the toilets more attractive. Single body ceramic toilets made the decoration process easy. Engraved copper plasters and hand-made foil patterns were used in decorations. That was an expensive process, and required skills. Decorations and dressing led to more custom-made designs (Blair, 2000).

In 1950s, after the discovery of plastics, toilet seats were made of plastics. The advantage of the plastic material was that it was very light; hence, the cover of the toilet seat was easy to open. Example of a plastic toilet is shown in Figure 2.43 (Hauffe, 1996).



Figure 2.43 1950's Toilet Sample (Blair, 2000).

The toilet design made of vitreous china, made by Gio Ponti in 1953 for Ideal Standard is exhibited in Philadelphia Museum of Art, a gift from Ideal Standard (Figure 2.44) (Marcus, 1998). Ponti was known for his plain designs; his designs mostly consisted of main forms as artifice and its combination with functionalism. (Trupia, 2007)



Figure 2.44 Gio Ponti's Toilet Design (Marcus, 1998).

Number of flushed toilets increased rapidly over the following decades (Anitei, 2007). However, the previous endeavors in trying to remove the heavier waste with jet-flush resulted in excessive use of precious fresh water in flushed toilets. The improvements in toilet design in the 20th century focused on reducing the water consumption.

In 1980 the designers at Caroma developed DuoSet toilet that reduced the usage of flushing water by half in response to Australia's limited water resources. The original design was improved in 1994 to reduce the water usage from 27 liters to 18 liters per person. ("DuoSet dual,"(n.d.)

Many toilets were built from the ceramic material except toilet seats parts. Toilets seats are made from various materials. One of them is wood. Natural materials were used in toilet designs in 1990s. The toilet with wooden seat is shown in Figure 2.45 from 1999.



Figure 2.45 Double Trap Syphonic WC Suite (Blair, 2000).

U. S. government also took action to reduce the water consumption of flushing toilets. Beginning in 1994, the usage of flushing water was restricted to 6 liters in households. The high-efficiency toilets (HETs) were developed in response to this act. The most recent HETs can reduce the water consumption by 20% of the required consumption of 6 liters (“Plumber Projects,” 1994).

Today’s toilets are designed in lots of different concepts and since toilets were in the bathroom, they were designed as part of the whole bathroom concept. Mechanism is already considered in general. According to daily conditions new properties are added continuously. . Those properties were constituted in the functions, forms, colors and water usage of toilets stemmed from the changes of mankind needs day to day. Starting with 20th century, there are many different concepts in industrial design. Some of the design concepts today are simplicity, personalization, globalization, emotional design, saving the earth, and so on. The most dominant concept is saving the earth because of the insufficient water supplies, ozone depletion, and global warming.

Changes and trends and many other factors like in the flushed toilet evolution affect the Turkish toilet history as well. The Ottomans were slow to follow the industrial revolution and technological advancements in the West. By considering the developments in the squat toilets during the period of the evolution of flushed toilets, in order to catch up with the rest of the World, they introduced improvements in the squat toilet design. Those improvements were mainly related with the materials used and the drainage systems. However, after 19th century, the Turks embraced the technological and scientific advancements in the West and transformed their daily life accordingly. Thus, in many of the houses in Turkey both flushed and squat toilets can be seen (Pekşen, 1998).

Today, there are not significant changes in the form of squat toilets. The only significant improvement was that after the invention of flushed technology, the squat

toilets were equipped with this mechanism to increase hygiene and decrease bad odors.

The last mechanism of flushed and squat toilet is built according to siphon system (Figure 2.46, 2.47) (Blair, 2000).

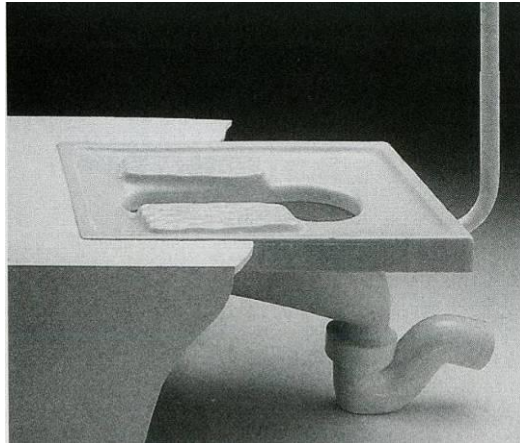

Figure 2: 46 The Section of Squat Toilets (Blair, 2000)

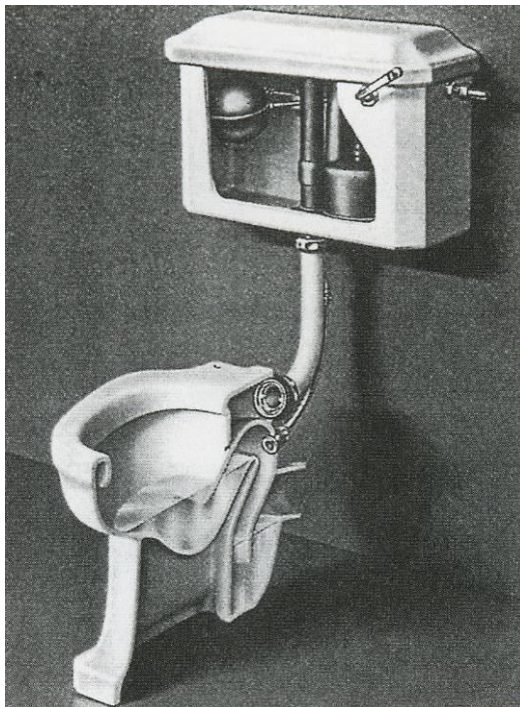

Figure 2.47 The Section of Flushed Toilet (Blair, 2000)

Following section investigates the material of toilet design. Moreover, the advantages and disadvantages of squat and flushed toilets in detail are analyzed in order to understand the factors affecting the design.

2.2 Materials used in Toilet Production

In the past, various materials were used in sanitary ware products before ceramic materials. Today, ceramics materials are generally used because of their properties such as hygiene. Some of the flushed toilets' parts are made from ceramic such as tanks and bowls. The other parts of flushed toilets such as toilet seats are made from two materials. One of these materials is polystyrene. Wood and plastics are used more than polystyrene because of less cheap ("Portable Toilet," (n.d.))

Materials selected for the production of squat toilets vary according to where they are placed in. For example, in trains, stainless steel is used (Figure 2.48). Artificial stones and plastics are the other materials that are used in squat toilet designs (Figure 2.49).



Figure 2.48 Stainless Steel Squat Toilets ("Beijing venues," (n.d.))



Figure 2.49 Plastic Squat Toilets (“Flushable squatting,”(n.d)).

Today, ceramic material is used in wet interiors like kitchen, bathroom and toilets. It has great dexterity against water and humidity. It also helps to avoid heat loss, and prevents voice pollution. Besides places like kitchen and bathroom, ceramics can also be used at the outer faces of buildings.

One of the most important properties of ceramic material is that it can be designed to be bacteria-resistant. Thus, products such as toilets made out of this type of ceramic material can be cleaned with less effort. Many firms took advantage of this new technology and introduced new products that used this material. With the changes in ceramic surfaces technology, the sanitary ware products are more hygienic than they were in the past. (“Serel Extra,”2005).

2.3 Advantages and Disadvantages of Squat and Flushed Toilets

According to a recent survey of Türkiye Başbakanlık Toplu Konut İdaresi Başkanlığı (Housing Development Administration of Turkey), the house sales in five cities were lower than the sales in the rest of the country. It was found that extended families and families with more traditional roots tend to prefer houses with squat toilets. In Malatya, Siirt, Kayseri, Van and Kars where it is very common to have several generations living in the same house, 18.4% of the population wants to have squat toilet in their residences, 67.5% of the population prefers to have both, and 2.6% wants to have flushed toilet only (“TOKİ'den konut,” 2007).

According to Vitra firm researches, a Turkish sanitary ware producer that is one of the twelve major firms that provide half of the ceramic sanitary ware production in World Ceramic Sector (Kafalı, 2005) and is a leading contender in many European markets, including Germany and the UK, squat toilets are losing their popularity today. Until the last twenty years, squat toilets have been in the majority of the houses except the big cities of Turkey. Squat toilet sales are decreasing continuously even though there are customers who prefer to have both flushed and squat toilets in their houses. On the other hand, the sales of the flushed toilets are increasing (Varlık, 2008).

There are advantages and disadvantages of squat and flushed toilets. One of the advantages of squat toilets is the squatting posture that helps achieve better relaxation while defecating, and consequently, prevent contamination of small intestines and related diseases (Rad, 2002). In flushed toilets, sitting posture does not provide any of these benefits. Another advantage of squat toilets is that they are sustainable unlike flushed toilets.

One of the disadvantages of the squat toilet is that it is not very comfortable for people, especially for elderly with knee problems, to squat (Karamehmetoğlu, 2006). Flushed toilets are more comfortable since many people especially elder people have

difficulty in squatting while defecating because of their health problems. Another disadvantage of squat toilets is related to its hygiene. It is argued that the footrest may get dirty and a person would carry all those microbes around. This may not be a big problem for in-house toilets because most of the people in Eastern countries take their shoes off at the entrance of the house and put them back on only when they are going out. However, it may create an issue for public toilets that are used very often and unfortunately cleaned less frequently. Moreover, over the last decade, bathrooms transformed from places where people visit two or three times a day as needed into places where people relax and spend more time in. Thus, flushed toilets are comfortable for people who spend time in bathrooms. However, squat toilets are, in general, designed as set-alone in separate rooms and are not as part of the bathroom concept like flushed toilets.

2.3.1 Comparison of Squatting and Sitting Position

There are some studies comparing squatting posture in Iranian toilets that are similar to squat toilets, with sitting posture in flushed toilets. Results of one of these studies indicate that the squatting posture has benefits over sitting posture, specifically, health related benefits (Rad, 2002) (Figure 2.50).

In squatting posture, the womb muscle stretches tight, knees press to the stomach, and consequently, bladder is under pressure. In this posture, there is no urine left in the bladder. If there is any urine left after defecation, then bladder stone may form and prostate problems may occur. Thus, it is important that the bladder is emptied. According to Iranian radiologist, Dr. Saeed Rad, a researcher investigating sitting and squatting posture, relaxation (after defecation) is not complete in sitting posture however in squatting posture, relaxation is completed easily (Rad, 2002) (Figure 2.51).

Some advantages of squatting posture are as follows: 1) Seals the valve between colon and small intestine; in the sitting position, this valve leaks frequently, and then

contaminates small intestine, 2) prevents the prostate, bladder, and uterus nerves from being damaged, and 3) prevents straining that may cause hernia (“Health Benefits of”, 2001).

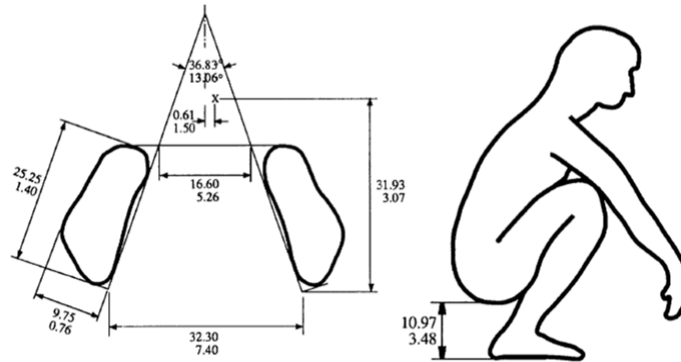

Figure 2.50 Public Squat (squatting-type) Toilet Design
(Dengchuan and Manlai, 1994).

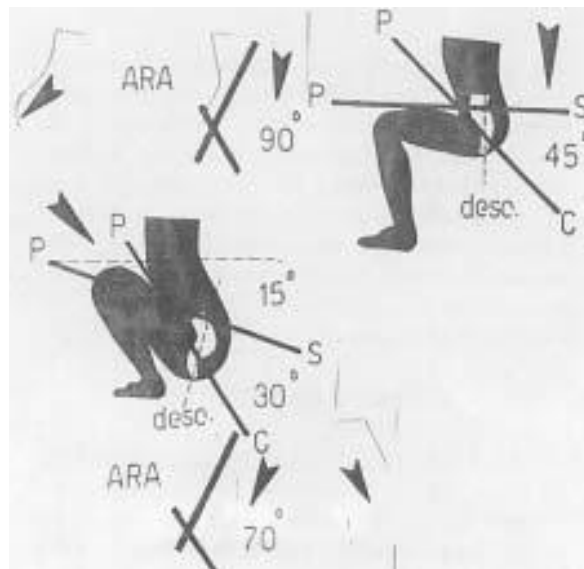

Figure 2.51 The Anorectic Angle in Two Different Positions of Bowel Evacuation
(Rad, 2002).

2.3.2 Toilets as Sustainable Alternatives

Today, environmental issues and sustainability are differentiating factors among many sectors including sanitary ware sector. Increasing world population brings new challenges to how we perceive environment and sustainability (Carter, 2006). The consumption of fresh water in flushing toilets used by billions of people creates a tremendous problem in terms of waste of natural resources. In addition, environmental pollution caused by human waste and resulting unhealthy conditions are making designers take steps towards developing products that help mitigate these concerns. According to Quitzau (2007), if the designers do not change the design of flush toilets, it could result in environmental downfall of the world. Percentages of water usage at home are presented in the Figure 2.52. Flushing toilet wastes so much water compared it to the water used the other activities at home; %30 percent of water is wasted in the toilets.

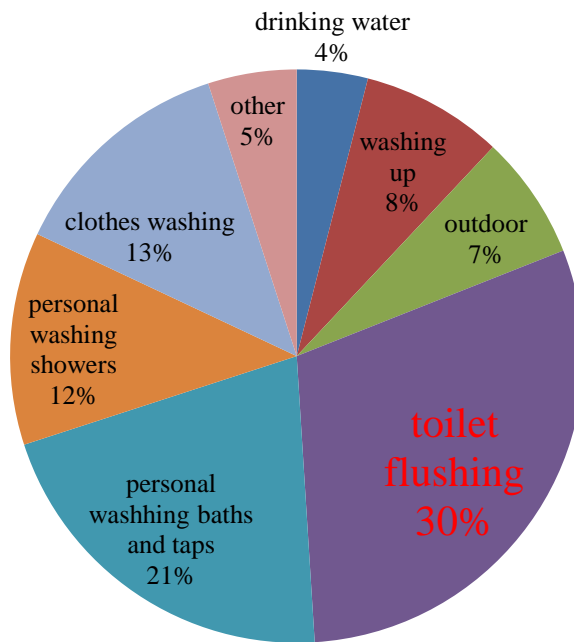

Figure 2.52 Water Use at Home (“Saving water,”(n. d.)).

Products geared towards improving ecological sanitation is becoming a differentiating factor in the market. Many designers are shifting their focus to design eco-friendly products and consumers are more inclined to purchase these products. The result of this new trend, ecological sanitation, is seen in toilet designs as well. The ecological toilet designs can be categorized in two groups: 1) water-efficient designs, and 2) designs that help collect human waste to be used in various areas such as producing fertilizers. The water-efficient toilet designs were targeted toward improving the efficiency of flushed toilets. Squat toilets are already better than flushed toilets in terms of water usage. However, the mechanisms used to improve water efficiency of flushed toilets can easily be adapted to the squat toilet designs to improve their efficiency as well (Esrey et al., 2000).

During the last 20 years, manufacturers have been trying to design high efficiency toilets to decrease tank capacities. Some of the sanitary ware firms in Turkey are trying to make a difference with their high efficiency toilet designs, and asking the national community to emphasize the importance of toilets that flush less water ("Serel'den Çevre," 2008). For example, in 2004, Vitra, a leading Turkish sanitary ware producer as mentioned before, developed water-efficient toilets with specific internal designs to reduce the water usage to from 13 liters to 4.5. Later, Vitra developed water-efficient dual-flush toilets that have two-section tanks (of 3, 5 and 6 liters water) with control buttons for two-step flushing function (Figure 2.53). Water-efficient toilets were developed by other ceramic sanitary ware companies in Turkey as well. Serel, another leading Turkish sanitary ware producer, introduced Smart Asma Toilets (Figure 2.54) that provide complete internal cleaning of the toilet from human waste by just 4.5 liters of water.



Figure 2.53 Dual Flushed Toilets (Raf, 2008).



Figure 2.54 Serel Smart Asma Toilet (“Serel’den Çevre,”2008).

Alternatives to the high efficiency toilets have also been considered by designers and developers. There are some other alternative toilets that use less water or do not use

water at all. General names of those toilets are composting toilets. There are various types of composting toilets. Some of them are forced air and electric toilets. Others are 'earth toilets', composting toilets, vacuum toilets. All of them have the same goal: less water consumption (“Serel’den Çevre dostu,” 2008; Del Porto and Steinfeld, 2000) The first composting toilet in the history was invented by Henry Moule in 1860s (Figure 2.55). It removed the necessity for cesspools. The removal of the cesspools from the toilet designs was important because cesspools carried the risk of contaminating the drinking water (Wright, 1960).

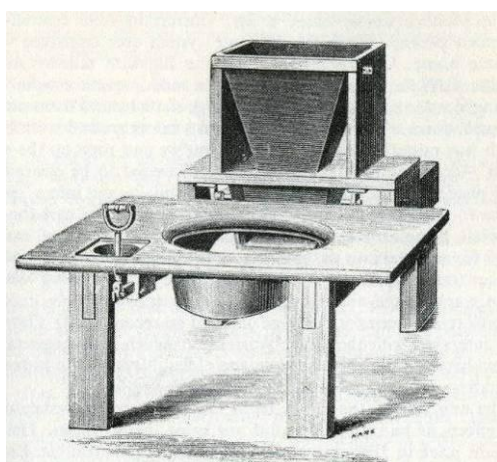

Figure 2.55 Henry Moule Earth Toilet (Wright, 1960).

Today, according to Quitzau (2007), one of the eco-friendly alternative toilets is the “squat toilet” that prevalent in many parts of Asia, Europe and Africa. Factor contributing to this opinion might be the design of waterless toilets used to collect human waste to make fertilizers is similar to that of squat toilets. (“Serel’den Çevre dostu,” 2008; Del parto and Steinfeld, 2000)

Throughout world history there have been civilizations that tried to make use of human waste rather than simply throwing it away. For example, American Indians, Eskimos, and indigenous people of Siberia had used human waste to store animal

skin. As another example, it is known that people had mixed coal dust with urine to make tattoo ink (Horan, 1997).

The most common use of human waste is preparing fertilizers. Thus, the other group of eco-friendly toilet designs are focused on designs mitigating the environmental damage due to high concentration of human waste by converting it to fertilizers. During the ancient times, people have worked on developing methods and designs to collect human waste to be used as fertilizers. Today many designers and researchers are investigating new and *efficient* ways to collect and reuse human waste *without causing any unhealthy conditions* (i. e. , sanitary safe environment). In the next section, a selected list of existing ecological toilets that resemble squat toilets are presented.

2.3.3 Sanitation Without Water: Ecological Toilets

Up to this point, the human excreta are referred to as human waste in this thesis. This is because the water-based sewage systems were built on the hypothesis that human excreta are a waste to be disposed of, and that the environment can assimilate this waste. A sanitation system that provides Ecological Sanitation (EcoSan) is a cycle—a sustainable, closed-loop system. The EcoSan approach is a holistic one that integrates ecologically and economically sound sanitation, and forms a bridge between sanitation and agriculture (Langergraber and Muellegger, 2005).

In the flush toilets, 4.000 gallons of drinking water are used per year according to SIDA (Swedish International Development of Cooperation Agency) (Esrey et al., 2001). Fresh water is not used only in toilets but also in bathroom and kitchen. The wastewater collected from toilets is called blackwater; water wasted from bathroom and kitchen is called as greywater. Both blackwater and greywater are combined with stormwater and industrial wastewater in the same pipe to be rid off. It is

predicted that the negative impact of using fresh water in toilets is greater than that of using fresh water in the other areas (Figure 2.56) (Esrey et al., 2000).

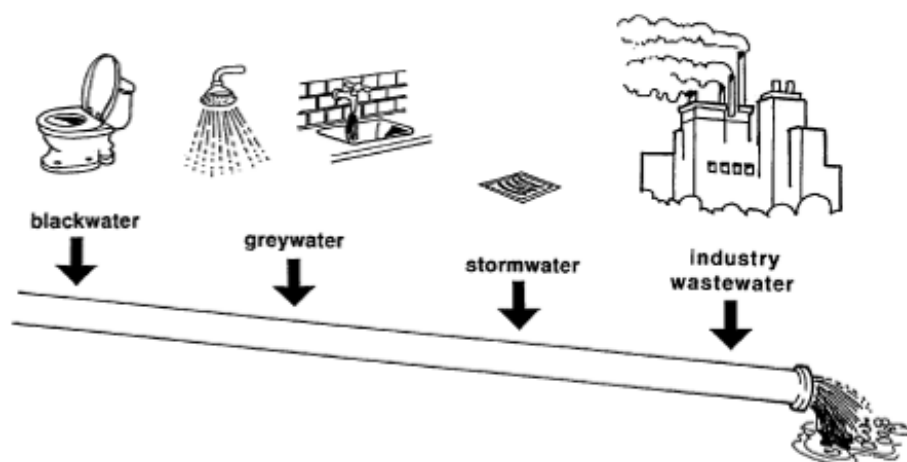

Figure 2.56 Collection of Various Sources of Waste Waters in a Single Pipe, (Esrey et al., 2000).

Ecological toilet designs are very similar to the design of squat toilets without the sewage systems. In place of sewage system, ecological toilets have small containers to collect urine and feces separately. The ecological toilets are designed to support a cycle of ecological sanitation by enabling reuse of human waste (Figure 2.57). The resemblance of ecological toilet and squat toilet designs confirms the hypothesis of Quitzau on how squat toilets can undo the environmental damage caused by flushed toilets (Quitzau, 2007). Today, examples of ecological toilets can be found in such countries like Vietnam, India, and Yemen.

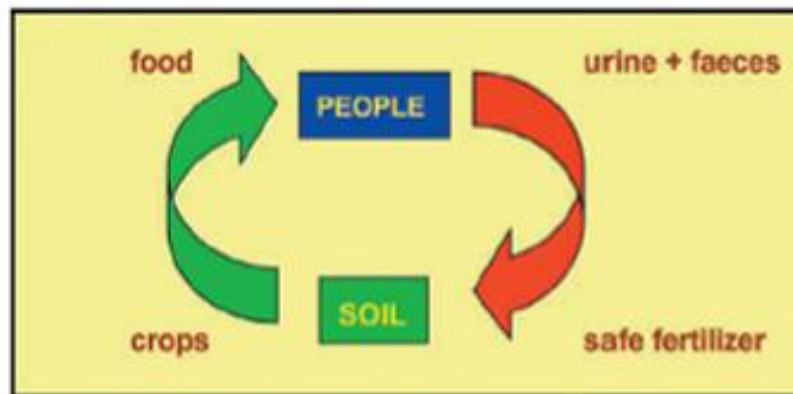

Figure 2.57 Ecological Sanitation (Esrey et al., 2000).

Contemporary waterless Vietnamese toilets resemble squat toilets. The upper part of the toilet design matches the design of squat toilet so that people squat over the hole. In the latrine, there are two holes, two footrests and a channel for urine just like in squat toilets. The main difference of the squat toilet from Vietnamese toilets is the sewer system present in squat toilets. The sewer system in squat toilets is replaced with a processing cycle that enables reuse of human feces in ecological toilets (Winblad et al., 1978) (Figure 2.58).

Vietnamese toilets have two containers to collect urine and feces separately. The urine flows to the inside container while the human feces flows to the outside one. There are advantages to collect urine and feces separately. The containers have handles to hold and empty them easily when they are filled. The human waste collected in the containers of ecological toilets is converted to fertilizers after a complicated chemical process that extracts the nutrients necessary for healthy growth of plants (Figure 2.58) (Winblad et al., 1978).

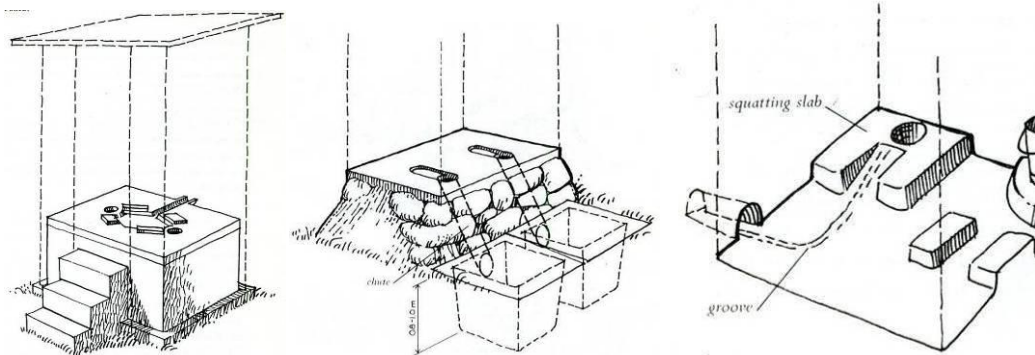

Figure 2.58 Example of Waterless Toilets (kaynak??)

The existence of squat toilets in India in ancient times was mentioned in the section on toilet history. Contemporary Indian toilets do not use water just like Vietnamese toilets. There are two types of latrines used in India: 1) gopuri and 2) sopa sandas. Gopuri latrine has a bottom with a structure that resembles honeycomb. It also contains a metal sheet cover in addition to squatting slab. There is ventilation pipe for fresh airflow to get rid of smell. The other Indian --squat like-- latrine is sopa sandas that has two holes opening to two-drip groove connected to the containers outside of the latrine (Winblad et. al, 1978).

The waterless toilets in Yemen also resemble squat toilets. Many of the houses have one or two toilets. The human waste fall, through hole into a container placed at the bottom of the apartment (Winblad et. al, 1978)

In Sweden, there is a growing market on manufacturing of urine-diverting toilets. However, according to Swedish researchers, the urine must be stored in a covered container with restricted ventilation to prevent conversion of nitrogen to ammonia. This is very important in efficient conversion of the urine to fertilization. The urine diverted from urine diverting toilets is stored for six months before being it spread over the cereal crops. Illustration of example of a urine diversion toilet is in Figure 2.59. This urine diversion toilet is a squatting-pan that resembles squat toilets without footrest (Figure 2.60) (Esrey et al., 2000).

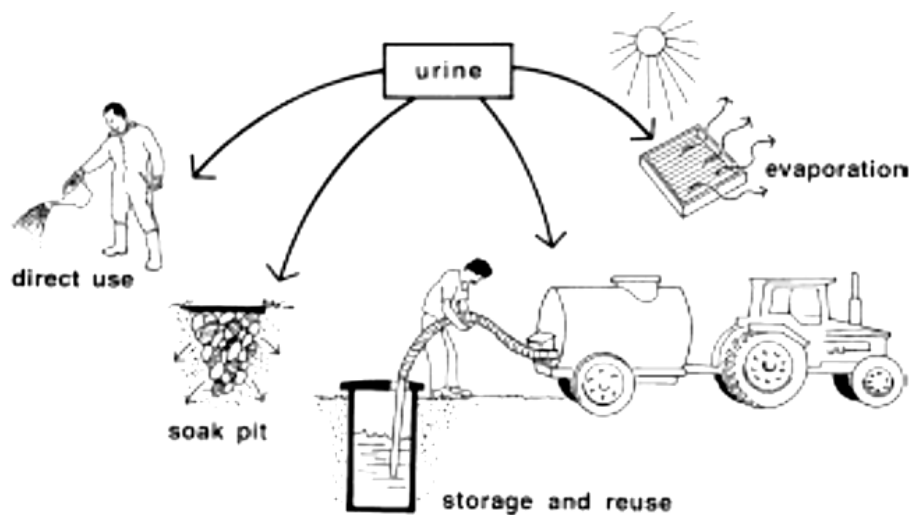

Figure 2.59 Alternative Ways of Handling and Using Urine Diverted from Toilets.

(Esrey et al., 2000).

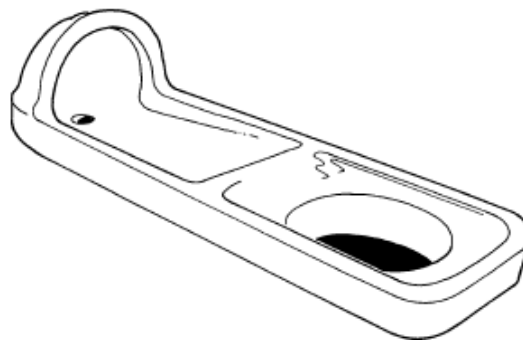

Figure 2.60 Squatting Pan with Urine Diversion, Made of Porcelain.

(Esrey et al., 2000).

2.3.4 Attempts to Combine Flushed Toilets

There have been few attempts to combine the advantages of flushed and squat toilets. In order to follow the evolution of these attempts, a patent survey is conducted using the patent search tool provided on the Internet. The keywords are

sitting-squatting posture, portable, adjustable seats. It is not evident whether the designs in these patents were turned into products or not.

As mentioned before, one of the advantages of squat toilets is squatting posture that enables maximum relaxation and provides health benefits when compared to sitting posture (Rad, 2002). In 1898, William Bliss designed a toilet that is called Privy Stool, that was the combination of the squat and flushed toilets (Horan, 1997). Figure 2.61 Privy Stool resembled Flushed toilet but the toilet seat had a special design that resembled the footrests of squat toilets. Thus, users can squat over the bowl while their feet rest on the toilet seat. However, squat position seemed too difficult to hold given the height of the toilet seat from the ground level (Bliss, 1898).

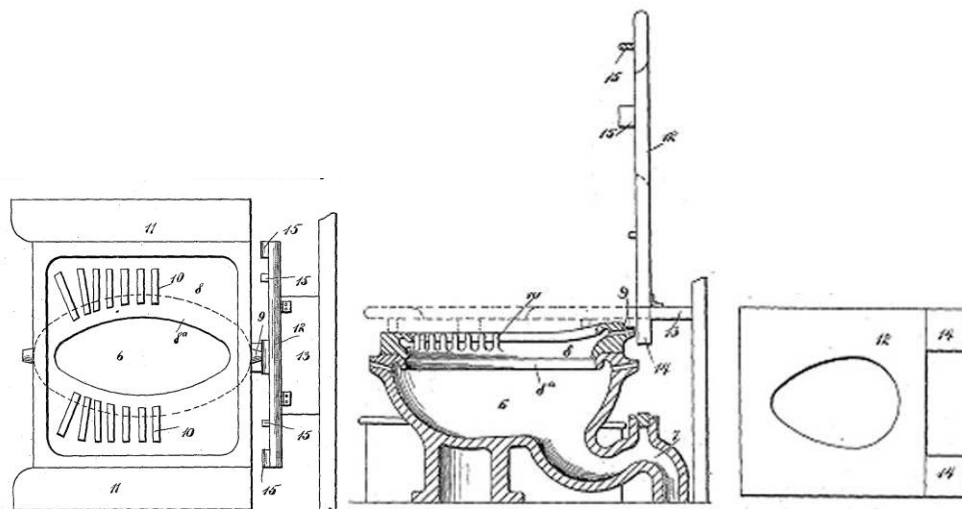

Figure 2.61 William Bliss Design (Bliss, 1898).

Another patent is a portable apparatus that provides support for squatting posture for flushed toilets as illustrated in Figure 2.62 (Urso, 2000). Users put their feet on step provided by the apparatus and rests their shoulders on the armrest.

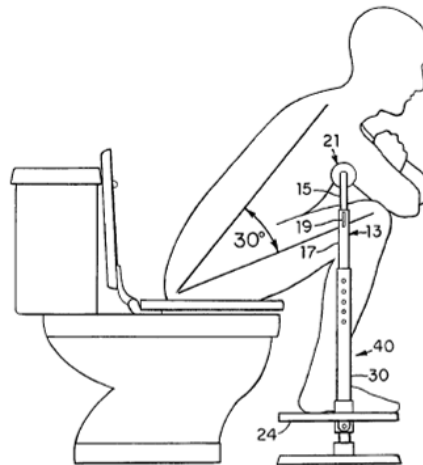

Figure 2.62 Portable Squat Support (Urso, 2000).

In 1977, Kristoffersen invented the dual function (sitting and squatting) water toilet shown in Figure 2.63. When the toilet seat is raised to upright position, the toilet is used as a squatting toilet. When the toilet seat is folded down to the lower part of the toilets, it is used as sitting toilet (Kristoffersen, 1977).

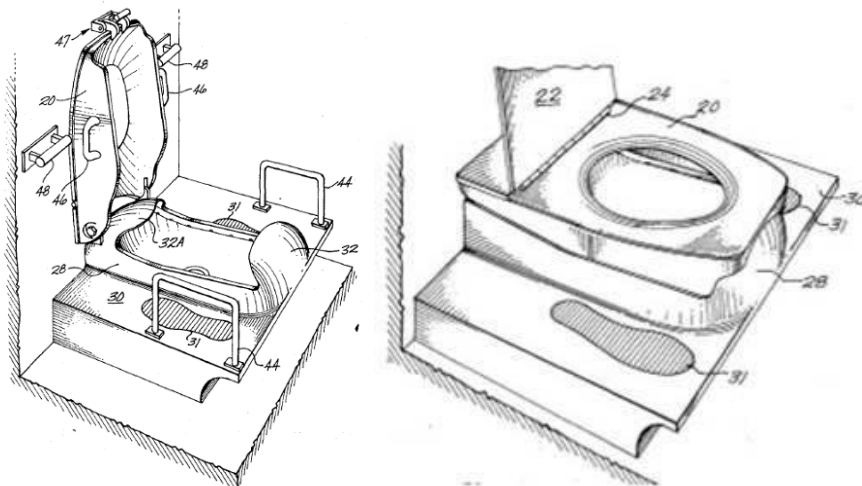

Figure 2.63 Sitting/Squatting Water Toilet (Kristoffersen, 1977).

In 1983, Minoru Sakamoto invented adjustable toilet bowl seat and footrest, illustrated in Figure 2.64 (Austin, 1979). The toilet seat was raised to provide squatting position in flushed toilets. Thus, the user can rest comfortable on the seat while keeping squatting posture.

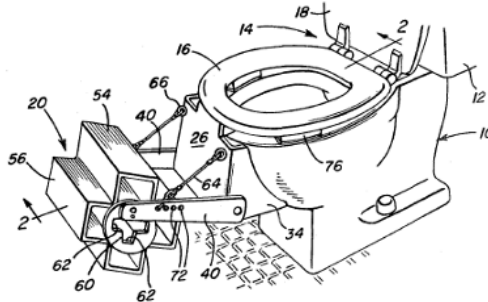

Figure 2.64 Sakamoto's Adjustable Toilet Bowl Seat and Footrest (Austin, 1979).

Patents similar to the patents presented above were granted to Turkish inventors as well. In 1970, Eczacıbaşı, Vitra and Or-an Mass Housing organization organized a contest that aimed to design a toilet that could be used as both squat and flushed toilets. The design of Sadun Ersin illustrated in Figure 2.65 had a degree in this contest while there is no resource on the rank of Sadun Ersin's design in the contest (Doğan and Altan, 2007).

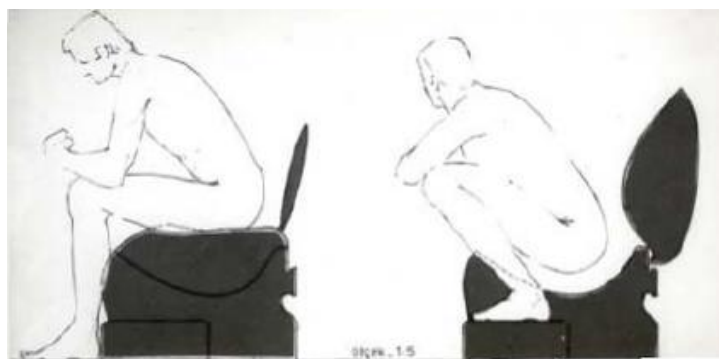

Figure 2.65 Sadun Ersin's Design of an Attempt to Combine Squat and Flushed Toilets Presented (Doğan and Altan, 2007)

Another toilet accessory to combine the advantages of squatting posture and flushed toilets was invented by Jonathan P. Isbit around 2001. His design resembled Privy Stool except that the footrest seen in squat toilets was not a part of the toilet seat. A diagram illustrating how this accessory is attached to flushed toilets is in Figure 2.66.

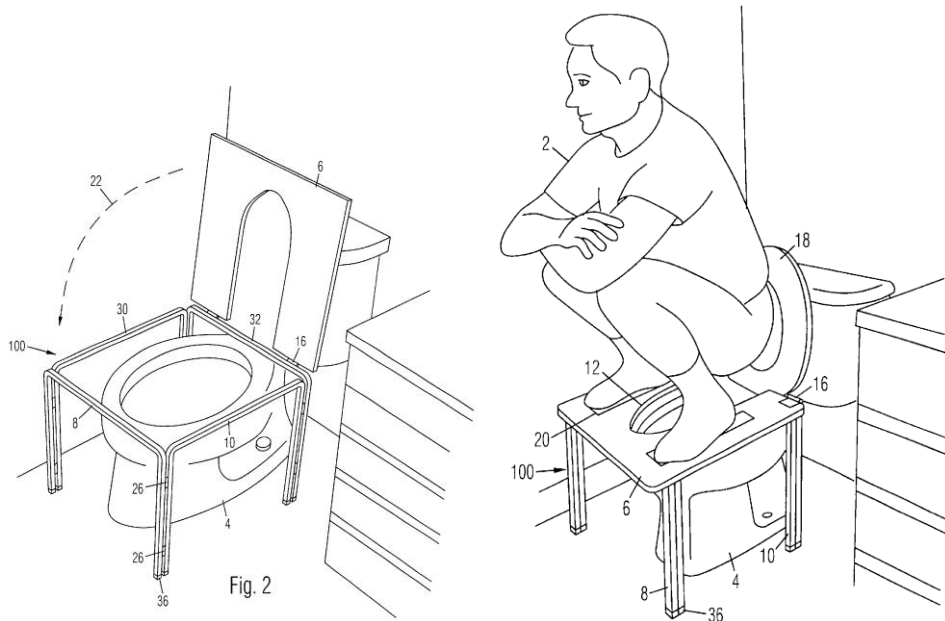

Figure 2.66 Jonathan P. Isbit Toilet Accessories for Flushed Toilets (Isbit, 2001)

2.3.5 Attempts to Combine Squat Toilets

There are some accessories that convert squat toilets to flushed toilets. Traditional Japanese toilet is a good example of these types of toilets. Thus, people can choose which toilets they want to use (Figure 2.67).



Figure 2.67 The Parts Attempt to Squat Toilet (“Toilet transformer,” 2007)

Another example is designed for elderly and people with disabilities. There are handle bars to hold while using the squat toilet.



Figure 2.68 Accesories of Handles to Hold (VitrA Bathroom Culture, (n.d.))

2.3.6 Comparison of Flushed Toilets with Squat Table

The comparison of advantages and disadvantages of flushed and squat toilets are provided in a table with short descriptions (Table 2.2).

Table 2.2 Comparison of Advantages and Disadvantages of Squat and Flushed Toilets

	Advantages	Disadvantages
Squat Toilets	Squatting position provide better relaxation after defecation	Not hygienic
	Use less water	Physical difficulties
		Elder people and people with disabilities can not use
		smell
Flushed Toilets	Hygienic	Sitting position is not healthy because few urine left in the bladder.
	Adjustable button to flushed	Use much more water than the squat

2.4 A Brief Overview of Turkish Ceramic Sanitary Ware Production

Ceramic production is the oldest production type. Ceramic is used in various forms and areas such as pottery, toy, jewelry, bowl, and so on. From ancient times to present, ceramic has been an important tool for mankind in daily life not only because of tradition, but also its material properties.

Day by day, the tradition of shaping ceramics for various purposes becomes a large industry. The products include ceramic tiles, sanitary wares, household ceramics, technical ceramics, and refractory ceramics. The others areas are; engineering, space ships, and sanitary ware. Ceramic material is important for ceramic sanitary ware products because of its properties; durability, reliability, hardness, high mechanical strength at high temperature, low intensity, optical conductivity, and thermal insulation (Liang and Dutta, 2000).

The history of sanitary ware and ceramic production in Turkey are intertwined. Turkish ceramic sanitary ware firms play a key role in responding to the trends in toilet design with their innovate designs as well as introducing new concepts in toilet and bathroom.

This section attempts to investigate the ceramic sanitary ware sector and history starting from early ages to today's modern Turkey; to learn which factors affect the development of ceramic sector; to understand how ceramic sector becomes stronger not only in Turkey, but also in global market; to understand the place of ceramic sanitary ware in the sector.

There are many firms that manufacture ceramic sanitary ware products in Europe. (Table 2.3). There are twelve major firms in the world that provide half of the ceramic sanitary ware production. The percent share of production capacity these twelve firms are shown in Table 2.4. According to (Kafalı, 2005), VitrA has 5% share in this market among these twelve firms. These firms have factories and offices all over the world. Their total production capacity reached to one hundred twenty millions units per year in 2004 (Kafalı, 2005).

Table 2.3 Ceramic Sanitary ware Production of Europe (1000 unit) (Kafalı, 2005)

country	1998	1999	2000	2001	2002	2003
Italy	10.047	9.661	9.572	9.609	9.732	9.533
Turkey	6.765	6.780	7.000	6.950	7.600	8.500
Spain	8.097	8.502	8.448	8.215	7.551	7.034
Portague	5.212	5.860	6.400	7.992	6.594	6.788
France	6.843	5.970	5.912	5.829	5.081	4.710
England	7.027	6.684	5.448	4.820	4.323	3.799
German	3.695	3.610	3.654	3.638	3.555	3.524
Scandanavia	2.390	1.838	1.775	2.675	2.748	2.635
Belgium	1.873	1.358	1.416	1.303	1.201	1.220
Austria	1.094	948	914	9.39	922	828
Greece	868	916	945	7.70	786	778
total	53.911	52.127	51.484	52.740	50.093	49.349

Table 2.4 Twelve Ceramic Sanitary Ware Firms in the World (Kafalı, 2005).

	Firm name	Country	Capacity (table/year)	Number of facility
1	American Standart Companies INCC	USA	28.000.000	23
2	Roca Group	Spain	26.500.000	14
3	Sanitec Group	Finland	16.100.000	9
4	Toto Corporation	Japan	11.500.000	10
5	Kohler Group	USA	9.500.000	7
6	Villeroy & Boch	German	5.500.000	7
7	CISA	Chile	5.500.000	3
8	VitrA	Turkey	4.250.000	2
9	Civita Castellana	Italy	4.000.000	1
10	RAK Ceramics	United Arab Emirates	2.900.000	3
11	India Sanitary ware	India	2.000.000	2
12	Duravit	German	1.960.000	6
	Total		117.710.000	87

American Standart is a leader in ceramic sector. The firm production consists bathroom and kitchen products. Quality and innovation are their legacy (“American Standart,” (n.d.)). Roca group was built by the Roca brothers at 1917. According to the related statistics, Roca group has had a great position in sanitary ware sector. The group believes that technology is the most important factor in market

competitiveness. However, they also value innovation, design, environment and especially consumer demand (“Roca Group,” (n.d.)).

Toto is another ceramic company. The headquarters of the firm is in Japan. Toto produces vitreous china ceramic sanitary ware. They also produce residential bathrooms and commercial restrooms. They developed toilets that used high technological developments (“Toto,” (n.d.)). Another USA firm in the world sector is Kohler firm. It was built in 1873. Their goal is to improve the standards of their customers. Among those twelve ceramic sanitary ware firms Vitra-Eczacıbaşı has the biggest (mega complex) ceramic sanitary ware facility in Bozhöyük with 530.000m² area. Vitra’s history started production in order to meet the needs for plumbing fixtures in 1942 with the opening of Ceramic Sanitary ware factory in Kartal, İstanbul (Vitra Bathroom Culture, (n.d.)).

According to Türkiye İhracatı Geliştirme Etüt Merkezi (IGEME) [Export Promotion Center of Turkey] reports, the production of ceramic sanitary ware capacity increases. The statistics in Yılmaz’s work (2006) is based on the most recent data that was collected in 2003. However, according to the very same report most of the products are exported because the *national consumption stays constant* despite the increasing production capacity (Yılmaz, 2006).

In the beginnings of the Republic of Turkey, there were some difficulties in each area. Economy was not good and the industry had a small share in economy. According to the first five years of reconstruction around the 1930s, the demand for a product had to be met in variety of sectors and ceramic was one of those sectors. Then, Government approved a sanction to build a porcelain factory. European specialists were brought to investigate the ceramic materials, and students were sent overseas to study ceramics and materials science. Despite Government initiatives, private sector was the first to invest in ceramics sector (Kafalı, 2005; “Türkiye’de Seramik”, 2002).

Just before World War II, a report on the need for building a factory in Istanbul to meet the demand on several ceramic items was in preparation by specialists in Turkey. However because of World War II, it was not built. In 1942, private investors started a small-scale business in Istanbul to produce ceramic tableware and ornaments (Kafalı, 2005; “Türkiye'de Seramik”, 2002).

Between 1948 and 1950, government started to support private enterprises. Dr. Nejat Eczacıbaşı was supported by Turkish government and built an electronic copper factory in İstanbul Kartal. However, the factory was closed because the production could not meet the demands. After he met the coffee cup maker Efim Pastellas, he converted the electric copper factory to tableware factory. Moreover, Efim Pastellas became partners with Eczacıbaşı until he went abroad. Eczacıbaşı bought Efim Pastellas and they setup a partnership. Then, Eczacıbaşı started to manufacture not only cookware but also ceramic sanitary ware (“Türkiye'de Seramik”, 2002)

While Eczacıbaşı built his firm, Ibrahim Bodur prepared his factory for the production of ceramic wall tile and porcelain isolator in Çan around the 1957s (“Türkiye'de Seramik”, 2002)

In 1960, Çanakkale Seramik started production in a modern ceramic factory built to produce floor and wall tiles. Until early 1960s, majority of the national demand for ceramic ware was supplied through imported products. However, in 1960s, harsh financial and economic conditions in the country led the newly founded ceramic companies increase the production in their factories (Kafalı, 2005).

In the 60s, there were many factories that were built by the businessmen and enterprisers. One of them was “factory of chinaware”, which was built by Sumer Bank, to help begin the construction of Bozhöyük and Yarımca factories. Thus, one year later after Bozhöyük factory was built in 1966s; Yarımca factory was built in 1967s. After the revolution of 60s, the factory of Çanakkale Seramik (Çanakkale

Ceramic) was the first private firm in the sector. Furthermore, it was the first firm that started to export their products abroad (“Türkiye'de seramik”, 2002).

In 1968, companies reduced ceramic imports to its minimal value because the national production was enough to supply the demand. The factories of Gorbun İşıl and the Istanbul Porselen Sanayi (Porcelain Industry of İstanbul) were built around 1970s (“Türkiye'de seramik”, 2002). There were new Turkish firms in the business in 70s: Ege Ceramic and Uşak Ceramic; Söğüt Ceramic and Heriş Ceramic; Kütahya Porcelain; Toprak Sanitary ware, Çanakçılar Ceramic. (“Türkiye'de seramik”, 2002). In 1990s, ceramic sector including the ceramics sanitary ware developed rapidly, and Turkey became one of the top nations in the market (Kafalı, 2005).

Ege Seramik was the third biggest ceramic tile manufacturer that was a pioneer in exporting and opened many sale offices in all around the world. Today it exports 55% of its products to the foreign countries (“Türkiye'de seramik”, 2002).

1990s were the period when ceramic rose higher in the Turkish industry. Mineral enrichment programs were started. Technological power and dynamic designs became focus points in differentiating products. In 1990s design started to play a critical role in sanitary ware production (Figure 2.69) During 90s firms collaborated with the universities and built studios in their factories to develop new designs. Many designers, native and foreign, studied with the firms to use the cultural richness to create modern designs (“Türkiye'de seramik”, 2002).



Figure 2.69 The Production of Toilets (“Eczacıbaşı Yapı Gereçleri,” 2006).

In 1998, Anadolu University and TÜBİTAK (The Scientific and Technological Research Council of Turkey) established the Ceramic Research Center. UNICERA (International Ceramic and Bathroom Fair) has been held in İstanbul every April since 1988.

Turkey with its rich and variety of sources has the advantage in ceramic sector. Turkey sells 65% of her cement raw materials reserve to other countries such as Italy and Spain (“Türkiye’de seramik”, 2002). The most important ceramic product line among the exports is the coating material with a share of 59%. The second product line is the sanitary ware with 25% share, third is the household and ornamental ceramics with 10% share, and refractory ceramics with 4% share. Worldwide production of ceramic sanitary ware is 200 million units per year. Europe (excluding the east European countries) is the biggest ceramics exporter after China in the world with 50 million products a year. Ceramic sanitary ware products are sink, toilet,

squatting pan, bidet, tap, urinal, washbasin, accessories and so on based on the most recent data collected in 2003 (Yılmaz, 2006).

The current position of Turkey in the ceramic sanitary ware is significant. In a short period of time, ceramic industry became a large sector in Turkey with its production of ceramic tiles, sanitary wares, household ceramics, technical ceramics, and refractory ceramics. Sector exports thirty percent of its production based on most recent data collected in 2003 (Yılmaz, 2006). Fifty-five per cent of the export goes to the European countries. Among the EU countries, shares of England, Germany, and France are 16, 12, and 7, respectively. The highest export rate to the countries other than EU is 11% (USA), 6% (Israel), and 5% (Canada) (Yılmaz, 2006).

As we have seen throughout the history of ceramics sanitary ware, it is important for the firms to be ahead of the industry in order to keep and improve their position in the market. The increasing competition among the manufactures of sanitary ware; standardization as a result of the industrialization; caused the manufacturers to concentrate on designs to differentiate their products from the competitors in the market. In order to differentiate a product from existing ones in the market, companies focused on various stages of the design.

Earlier, functionality was a differentiating factor. Later, with developments in technology, the functionality factor became less significant. After 2000, designers started to put the users' desires and needs in their design process. In 2004 and 2005, the focus shifted from functionality to user emotions.

In 2006 toilet designs were all about the cleaning systems, personal hygiene, and purity. There were many innovations in ceramic surface technology that became an important factor in design. Hygiene is an important factor in toilet design and throughout the history, ceramic material is used because of its properties that provide hygiene. Ultra clean system is a recently developed technology based on the glaze of the ceramic material. Ultra clean products are hard to get dirty but easy to clean. This

is because there is almost zero porosity on the product. Names given to the current products in Turkish sanitary ware market using these new materials and technology can be seen as the reflections of current concerns of the sector: Easy Clean (by Roca Kale), Extra Clean (by Serel), VitrAHygiene (by Vitra), and Ultra Clean (by Çanakcılar).

Not only technological development but also because of the many other factors caused pollution. Thus, eco-friendly products become important in the market in all sector. Moreover, The level of diversity needed in the market was achievable by integrating the functionality with the feelings and sensitivity of the user instead of functionality only. Today, the differentiating factor in world market and Turkey markets is having environmentally friendly products. More and more manufacturing companies are using sustainable and environmental materials in production. (Sherman, 2007)

In 2008 designs, efficiency is the theme since consumers prefer high efficiency toilets that flush less water; 60% of the total sales and 30% of the production consists of high efficiency toilets according to Vitra reports. President of the marketing and sales department of Eczacıbaşı Yapı Gereçleri/Vitra (Eczacıbaşı Construction Tools) stated that during the last five years they focused their research studies on water efficient toilets while keeping their high standards on hygiene and comfort (Varlık, 2008).

It is difficult to find examples of these contemporary trends being applied to squat toilets. However, there are few designers who are bringing new ideas to squat toilet design. An example of contemporary squat toilet design in this category is the design by İnci Mutlu and Gamze Türkoğlu Akay shown in Figure 2.70 for Vitra. Design of its footrest makes it different from the others in the market.

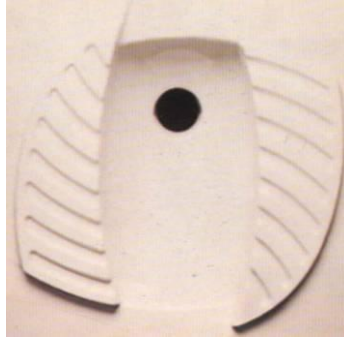

Figure 2.70 A Squat Toilet by Gamze Turkođlu Akay and İnci Mutlu for Eczacıbaşı Vitra (Özcan, 2006)

Another squat toilet designed by İnci Mutlu for Vitra (Figure 2.71) has footrest in circular form rather than most commonly used square design. On the other hand, its square basin helps to uniform with the standardized rectangular tiles on the floor. It is easily observed that the aesthetics is the differentiating factor in these designs.



Figure 2.71 Vitra Squat Toilet (“Vitra Bathroom,” 2008)

In the next chapter, research questions of the thesis are revisited in order to conclude the study by answering them in the lights of the literature review study presented in this chapter.

CHAPTER 3

CONCLUSION

The foremost question of this study was about the case of toilet's throughout the evolution of toilets in the history and their current state. In order to find the answer of this main question, following are examined also:

- How did toilets evolve in the history?
- Which factors have effected toilet designs throughout the history?
- What is the current situation of squat and flushed toilets usage in the world?
- What are the advantages and disadvantages of squat and flushed toilets?

The changing life styles and standards in time have formed people's toilet habits. Toilet habits differ according to many factors including social and cultural structure. Some societies prefer flush toilets, and others prefer squat toilets. Some people love reading books in the toilet, some just relieve themselves and some just relax. The factors that affect the toilet designs vary depending on target user groups, ergonomic data, behaviors and habits of people in social life, changing technology and trends in the life styles.

During ancient times, 8000 BC to 500 BC, cleanliness and hygiene were rooted in *culture* that is a blend of beliefs, values, behaviors. Thus, all the products they used including toilets were affected by their culture. For example, since the ancient Egyptians' beliefs about after life, they built toilets in pyramids for pharaohs. Another example is Roman's public latrines; Romans perceived toilets and bathrooms as means for socialization. For this reason, in their public toilets, there were no panels separating the toilets. They built lots of public baths and latrines, remnants of which still survive today. For Romans, hygiene and cleanliness were

exorbitant. They built sewer systems and aqueducts to have toilets cleaned of human waste automatically, and also designed tools such as to clean them by hand.

At the beginning of the Middle Ages, cleanliness and hygiene were not as important as it was in Ancient Times for many reasons mentioned in the previous chapter. In this period, *material* was among the factors affecting the toilet designs. The material of the toilets, especially of chamber pots, depended on the social and political status of their users. People of higher status had chamber pots made of precious metals such as silver while poor people had theirs made of kiln and copper.

Later, *privacy* became an affective factor in designing toilets, so the toilets were designed like furniture to conceal their real function. For example, chamber pots were put in wooden chests. In addition, *comfort* became another factor. People preferred toilet designs where they felt comfortable while sitting on. Thus, toilet seats were made of soft cloths rather than wood or other hard materials used for chamber pots. The status of the people still played a significant role. During Middle Ages, the toilet designs were *ornamented* with knickknacks such as adornment with embosses silver and gold to give an aesthetic impression based on the status of the owner. (Figure 2.69)



Chamber pots Ancient times-1800s	Garderobes 1189s-1530s	Close stool 1600s- 1800s
		

Figure 2.72 Toilet Examples from Ancient Times to 17th Century.

In the Middle Ages, there were no sewer systems in Europe. The human waste was thrown on the streets. Disposal of human waste onto the streets where humans walk every day generated horrible illnesses in this period. To summarize, the factors that affected the design in this period were;

- Comfort: When it was full; it was easy to empty it from window.
- Comfort: The act of sitting was easier than squatting.
- Hygiene was not important: They relieved themselves where they were, not necessarily into a cup or chamber pot.

Starting with the 1600s, changes in social life, beliefs, behaviors and technological developments were among the factors that shaped the toilets forms gradually till the 2000s. During this long period of time, people started to design toilets for one person because of increased emphasis on privacy. *Hygiene* became the most important factor again. People tried to find a mechanism to automatically clean the toilets without touching. Thus, flushed toilets were born. Another concern was to get rid of the bad odors. The mechanisms built to achieve new functions to overcome the challenges of flushing the toilets automatically and getting rid of smells required finding more rustproof and bacteria resistant materials. Historical data shows that ceramic materials were found as the best for the production of toilets because of their properties; ceramic can not be drawn and destroyed; it is easy to clean, nonporous but not absorbent, and its surface shines as a sign of cleanliness. Additionally, ceramics helped to shape toilet form easily. As all the mechanism of a toilet could be put in a one-piece ceramic form, the production of toilets became easier. Thus, the material affected the design considerations not only about form but also about production type as well.

Today, there are many different factors affecting toilet designs such as trends in life styles, ergonomics, environmental considerations, and technological developments. For instance, nowadays, researchers are developing materials that do not hold bacteria; hence, the toilets naturally provide hygiene and provide easier and safer

alternatives to cleaning in comparison with the previous toilets. High-efficiency toilets and alternative toilets to flushed toilets are built to overcome the challenges of depleting natural resources.

As the literature review study of this study shows, the squat toilets have been used in India, Far East and Anatolia since Ancient Times. Human's using the squatting position *instinctively* may have resulted in the squat toilets. For instance, children squat when they want to relieve themselves before they are toilet trained. Humans may have started building the toilets with the consideration of this position as a starting point.

There are advantages and disadvantages of squat toilets. Functional mechanisms such as flushed invented to improve flushed toilets were implemented in Squat toilets as well. The main advantages of squat toilets compared to flushed toilets are as follows:

- Squatting posture provides better relaxation while defecating that in turn helps prevent diseases in small intestines.
- Eco-friendly because they use less water.
- Sustainable because provides means to efficiently reuse the human waste as natural fertilizers.

There are also some disadvantages of squat toilets. For example, squatting posture may not be comfortable for all, especially for handicapped and elderly. Another disadvantage is about the hygiene, as it is argued that, as an issue for public toilets that are used very often and cleaned less frequently, the footrest may hold bacteria that would easily be spread around.

We already mentioned three factors that contribute to its decreasing popularity; comfort, exclusion of squat toilets from bathroom design concept, and insufficient

hygiene as a result of bacteria collection on footrest. On the other hand, increased concerns about extensive and irresponsible usage of natural resources are bringing squat toilets back as alternatives to flushed modern toilets. Moreover, squat toilets are being produced in some of the European countries such as in Sweden to reuse the human excretes as natural fertilizer for growing organic food.

Over the last two decades, bathrooms transformed into places where people can relax and live rather than places visited when needed. So, the amount of time spent in the bathroom is increasing. However, squat toilets are generally placed in separate rooms, not included as a part of the bathrooms as flushed toilets. This generates a full circle. Since squat toilets are not considered as part of the bathrooms, the evolution of their designs is not as significant as flushed toilets. When we look at history, we see that flushed toilets have always been constantly changing and evolving into better designs. The design is reviewed again according to today's trends. It can be observed easily that the trends affecting the designs of flushed toilets are not affective for the squat toilets.

Flushed toilets are much more hygienic than the squat ones. However, in public bathrooms some of the people prefer squat toilets. They say that in a day, many people seat on the same toilet seat. Actually designers find a simple solution to this problem. There are accessories. For example, in some toilets, specifically in airports, you can change the toilet seat cover with one handle. Flushed toilets are comfortable than the squat toilets. Sitting position is better for many people especially elder or people with disabilities. Sitting positions have disadvantages because after the defecation some of the urine left in the bladder. Thus, it causes some diseases. However, putting some of the accessories, which are mentioned in section 2.3.4, can help people relaxation in defecation.

Although there are flushed toilets which have two level tanks, and tank level is decreasing from 13 liters to 6 liters. Researchers believe that in the future it is not enough to save the fresh water.

There are not many studies on toilets, however, according to literature review study, current status of squat toilets as eco-friendly and sustainable alternatives to flushed toilets is extremely promising. Both of the toilet designs have disadvantages and advantages. However, the most important factor in toilet design today and the future is water efficiency. Thus, alternative designs of toilets need to be improved to better fit to the needs of more people including handicapped and elderly.

Turkey with all the resources of raw material that are used in ceramic sanitary ware production and with its world-wide known ceramic sanitary ware producers that have proved themselves in foreign markets has an important advantage in the world's ceramic industry, and is in a great position to respond to the above questions and lead the way for re-discovery of alternative toilets. There is no better alternative to tackle this challenge other than Turkish ceramic sanitary ware producers who have the resources, technology, and skill set.

REFERENCES

- Akın, E. (2008). *Antique Anatolian*. Retrieved May 26, from 2008, Antique Anatolia [www. antiqueanatolian.blogspot.com/](http://www.antiqueanatolian.blogspot.com/)
- _____, (n. d.). American Standard. Retrieved December 1, 2008, from www.americanstandard-us.com/companyinfo/overview.aspx
- _____, (n. d.). *The Ancient city Babylon*. Retrieved December 11, 2008, from www.toilet.isgreat.org/toilet-history-iraq.htm
- Anitei, S. (2007). *Flushing Toilets Could Trigger a Disaster in the Western World*. . Retrieved May. 2008, from www.news.softpedia.com/news/Flushing-Toilets-Could-Trigger-a-Disaster-in-the-Western-World-61608.shtml
- Angelakis, A. N., Koutsoyiannisb, D., Tchobanoglous, G. (2005). Urban wastewater and stormwater technologies in ancient Greece. *Water Research*, 39, 210-220.
- Ann, E., and Ciesko, M. (2002). Experience Design: Current And Developing Trends in Industrial Design and its Impact on Education. *The First China-US Joint Conference*, (s. 1-5). Beijing, China.
- Antoniou, G. P. (2007). Lavatories in Ancient Greece. *Water Science and Technology: Water Supply*, 7-1, 155-164, London: IWA Publishing.
- Austin, G. P. (1979). *Patent no. 4168552*. United States of America. Google patents.
- Aytaç, S. M. (2004). *The social and technical development of Toilet Design*. Ms Thesis. İzmir Yüksek Teknoloji Enstitüsü.

- _____, (n.d.). Bathroom. Retrieved December 20, 2008, from www.bathroomtoilet.org/
- _____, (n. d.). Beijing venues replace squat toilets. Retrieved November 12, 2008, from www.2008gamesbeijing.com/beijing-venues-replace-squat-toilets/
- Bellis, M. (2005). *The History of Plumbing*. Retrieved July, 2008, from www.about.com/
- Blair, M. (2000). *Ceramic Water Toilets*. Buckinghamshire. Shire Publications.
- Bliss, W. (1898). *Patent No. 4819277*. United States of America. Google patents.
- Brinkerhoff, P. (2007). History of Sewerage Management. *Environmental Development and Allied Professionals Western Group 7th Western Group's 58th Annual Regional Conference I*. Katoomba: Environmental Development and Allied Professionals.
- Carter, W. H. (2006). *Flushed: How the Plumber Saved Civilization*. New York: Atria Books.
- Cassius, D. (1995). *Roman History: Books LXI-LXX*. Cambridge, Mass: Harvard University Press.
- Chanson, H. (2008). The Hydraulics of Roman Aqueducts: What do we know? Why should we learn? *World Environmental and Water Resources Congress 2008 Ahupua'a*, 1-16.

- Chun, A. (2002). Flushing in the future: the supermodern Japanese toilet in a changing domestic culture. *Postcolonial Studies*, 5-2, 153–170.
- Churchill, C. and Walfof, L. (2006). The Adventures of Cristel Churchill & Liz Walfof. Retrieved January 8, 2008, from www.cristelchurchill.com/trips/London.htm
- Connolly, P. and Dodge, H. (1998). *La Ciudad Antigua*. La vida en la Atenas y Roma clásicas. Madrid. Acento
- Cooper, P. F. (2001). Historical Aspects of Wastewater treatment. In *Decentralised Sanitation and Reuse: Concepts, Systems and Implementation* (pp.11-39). London: IWA Publishing.
- Del Porto, D. , and Steinfeld, C. (2000). *The Composting Toilet System Book*. Concord, Massachusetts: The Center for Ecological Pollution Prevention (CEPP).
- Dengchuan, C. and Manlai, Y. (1994). An ergonomic approach to public squatting-type toilet design. *Applied ergonomics*, 29-2, 147-153.
- _____, (2008). *Design Cities 1851-2008*. İstanbul: İstanbul Modern.
- Doğan, C. and Altan, O. (2007). Kamusal Alanda Oturma Eylemi ve Ergonomik İlkeler. (Setting in public Spaces and the Ergonomic Principles) *YTÜ Mimarlık Dergisi*, 2-3, 163. İstanbul: İstanbul Teknik Üniversitesi.
- Dormer, P. (1993). *Design since 1945*. New York, NY: Thames and Hudson
- _____, (n.d.). *DuoSet dual flush toilet cistern*. Retrieved November 5, 2008, from www.powerhousemuseum.com/collection/database/?irn=126700

- Eagan, S. C. , and Gruber, P. R. (2008). We all are different. Retrieved April 26, 2008, from www.wvu.edu/
- _____ (2006). Eczacıbaşı Yapı Gereçleri Vitra. *Seramik Türkiye*, 17, 40-45.
- Esrey, S. A., Andersson, I., Hillers, A., and Sawyer, R. (2000). *Closing the loop: Ecological sanitation for food security*. Mexico: Sida and UNDP.
- Favro, D. (1997). Roman Latrines. *Places*, 11-1, 72-73
- _____ , (n. d.). *Flushable squatting toilet system*. Retrieved October, 13, 2008, from www.dmttoilet.com/newproduct.htm
- Geels, F. W. (2006). The hygienic transition from cesspools to sewer systems (1840–1930): The dynamics of regime transformation. *Research policy*, 35-7, 1069-1082.
- George, L. R. (2001). The history of Plumbing: Learning from past experiences. *Plumbing Engineer*, 45-52.
- Gülbay, O. (2003). *Eskiçağ' da Tuvalet Kültürü*. İstanbul: Ege Yayınları.
- Gültekin, M. (2007). Charles Baudelaire ve Modernizm. *Elektronik Sosyal Bilimler Dergisi*, 19-6, 82-94.
- Günay, R. (1998). *Tradition of the Turkish house and Safranbolu houses*. (Ç. Birkan, Trans.) İstanbul: Yapı-Endüstri Merkezi Yayınları.
- Gürel, M. O. (2008). Bathroom as a modern space. *Journal of architecture (London, England)*, 13-3, 251-231,

Graham, J. W. (1962). *The Palace of Crete*. Princeton: Princeton University Press.

Hauffe, T. (1996). *Design*. Hauppauge, N. Y.: Barron's.

_____. (n. d). *Health Benefits of the Natural Squatting Position*. Retrieved June 21, 2008, from www.naturesplatform.com/health_benefits.html

_____. (n. d). *A History of the Embossed Toilet*. Retrieved August 23, 2007, from www.victoriancrapper.com/Toilethistory.HTML

_____. (n. d). *History of the Toilet*. Retrieved November 2, 2008, from www.history.com/exhibits/modern/toilet.html

_____. (n. d). *The History of Toilets in Japan*. Retrieved January 24, 2008, from www.web-japan.org/kidsweb/hitech/toilet/toilet01.html

Hopkins, J. N. (2007). The Cloaca Maxima and the monumental manipulation of water in archaic Rome. *The Waters of Rome*. 2007-March, 1-15.

Horan, J. L. (1997). *The Porcelain God: a Social History of the Toilet*. Canada. Citadel Press.

Humphreys, K. (n. d.), *Lost World: Civilization Erased by Piety and Fanaticism*. Retrieved June 21, 2008, from www.jesusneverexisted.com/lost-world1.html

Isbit, J. P. (2001). *Patent No. 6256800*. United States. Google Patents.

Jansen, M. (1989). Water Supply and Sewage Disposal at Mohenjo-Daro. *World Archaeology*, 21- 2, 177-192.

Kafalı, M. (2005). *Sektörel Araştırmalar; Seramik Sağlık Gereçleri*. Ankara: Türkiye Kalkınma Bankası AŞ.

Karamehmetoğlu, Ş. S. (2006). Yaşlılar İçin Fiziksel Çevrenin Düzenlenmesi. *Türk Fizik Tıp Rehabilitasyon dergisi*, (özel ek), A50-A52

_____ (2008). Kişi başına düşen su miktarı gitgide düşüyor. *Tüm Gazeteler*.
www.
referansgazetesi.com/haber.aspx?HBR_KOD=93018&KTG_KOD=376

Kristoffersen, B. R. (1977). *Patent No. 4012797*. United States of America. Google Patents.

Langergraber, G. and Muellegger, E. (2005). Ecological Sanitation way to solve global sanitation problems? *Environment international*, 31-3, 433-44.

Laporte, D. (2000). *History of shit*. Cambridge, Mass: MIT Press.

Liang, Y. and Dutta, S. (2000). Application trend in advanced ceramic technologies. *Technovation*, 21-1, 61-65.

Mara, D. D. (1985). *The design of pour-flush latrines (TAG Technical Note No. 15)*. Washington, DC: The World Bank.

Marcus, G. H. (1998). *Design in the fifties: when everyone went modern*. Munich: New York: Prestel.

Matsui, A., Kanehara, M. and Kanehara, M. (2003). Palaeoparasitology in Japan - Discovery of Toilet Features. *Memórias do Instituto Oswaldo Cruz*, 98-1, 127-136.

Mattelaer, J. (1999). Some historical aspects of urinals and urine receptacles. *World Journal of Urology* 17-3, 145-150.

_____, (1994). *The Men That Made The Water Toilet. Plumbing and Mechanical*. Retrieved January 2, 2008, from www.pmmag.com/CDA/Articles/History_of_Plumbing/4d018163a3fc7010VgnVCM100000f932a8c0

_____. (1993). Meriam–Webster Collegiate Dictionary (10th ed.) Springfield, MA: Meriam-Webster.

Oddie, B. (1986). *The Toilet Book*. London: Methuen.

Özcan, C. A. (2006). H2O Not Water Everywhere Cultures Evolutionary Design Practices. *The 6th International Conference of the European Academy of Design*. Bremen, German.

Pekşen, S. (1998). *Banyo seramikleri tasarımında geleneklerin değerlendirilmesi*. [başlığın ingilizce tercemesi] Competency in Arts. Unpublished Masters ya da Doctorate Thesis. İzmir: University of Dokuz Eylül.

Perks, H. , Cooper, R and Jones, C. (2005). Characterizing the Role of Design in New Product Development: An Empirically Derived Taxonomy. *The Journal of Product Innovation Management*, 22-2, 111-127.

_____, (n. d.). Portable Toilet. Retrieved October 21, 2008, from www.madehow.com/Volume-3/Portable-Toilet.html

Quitau, M. (2007). Flushed toilets: Systemic development and path-dependent characteristics and their bearing on technological alternatives. *Technology in Society*, 29-3, 351.

Rad, S. (2002). Impact OF Ethnic Habits ON Defecographic Measurements. *Archives of Iranian Medicine*, 5-2, 115-117.

_____. (n. d.). Roca Group. Retrieved December 3, 2008, from <http://www.roca.com/>

Sakamoto, M. (1983). *Patent No. 4466140*. United States of America.

_____, (n. d.). Saving water at home. Retrieved November 4, 2008 from http://www.save-a-flush.co.uk/saving_water_home.html

Schladweiler, J. (2002). Tracking Down The Roots Of Our Sanitary Sewers Retrieved September 2008, from www.sewerhistory.org

_____, (2005). Serel Extra Clean *Journal of Seramik Türkiye*, 22-23.

_____. (2008). *Serel'den Çevre Dostu Klozet*. Retrieved July 21, 2008, from www.yapitr.com/UrunHaberleri/serelden-cevre-dostu-klozet_59472.html

Shaw, M. (2003). Housing and Public Health. *Annual Review of Public Health*, 25, 397-418.

Sherman, L. (2007). *Forbes*. Retrieved July 26, 2008, from www.forbes.com/style/2007/08/28/industrial-design-trends-forbeslife-trends07-cx_ls_0828design.html

Stone, M. N. (1979). The Plumbing Paradox: American Attitudes toward Late Nineteenth-Century Domestic. *Winterthur Portfolio*, 14-3, 283-309.

_____, (n. d.). *The Straight Poop on The History of the Toilet*. Retrieved January 23, 2008, from www.plumberprotects.com/history_of_flushing.htm#history

Taylor, C. (2005). The Disposal of Human Waste:.. *Past Imperfec* , 53-72.

_____, (n. d.). *Toilet*. Retrieved December 12, 2008, from The Science & Society Picture Library Web site: www.scienceandsociety.co.uk

_____, (n. d.). *Toilet hygiene as a highest virtue*. Retrieved December 11, 2008, from www.toilet.isgreat.org/toilet-history-greek.htm

_____, (2007). *The Toilet in Erzincan Üzümlü*. *Zaman Newspaper*. Retrieved January 15, 2008, from www.zaman.com.tr/haber.do?haberno=565713

_____, (n. d.) *Toilet with a great view of Potala palace*. Retrieved December 1, 2008, from www.traveladventures.org/continents/asia/potala-palace15.shtml

_____, (n. d.). *Toilet system near the Nile*. Retrieved December 11, 2008, from www.toilet.isgreat.org/toilet-history-egypt.htm

_____, (n. d.). *Toilet Timeline*. Retrieved December 11, 2008, from www.worldtoilet.org/resources.asp?no=6

_____, (2007). Toilet transformer zaps old-style Japanese squatters into the 21st century. Retrieved November 5, 2008, from

www.digitalworldtokyo.com/index.php/digital_tokyo/articles/toilet_trans
former_zaps_old_style_japanese_squatters_into_the_21st_century/

_____, (n. d.). *Toilets Around the World*. Retrieved January 21, 2008 from,
<http://www.theplumber.com/toilets-world.html>

_____. (2007). *TOKI'den konut alanlar, çevresel donatıları ve şartları yetersiz buluyor*. *Arkitera Architecture Center*. Retrieved September 21, 2008, from www.arkitera.com/h19284-tokiden-konut-alanlar-cevresel-donatilari-ve-sartlari-yetersiz-buluyor.html

Torunlar, B. (2007). *Arkitera Architecture Center*. Retrieved october 15, 2008, from www.arkitera.com/h19190-urartu-kalesi-kazi-onarim-calismasinin-ilk-yarisi-bitti.html

_____, (n. d.). *Toto*. Retrieved December 6, 2008, from www.totousa.com/#

Türker, E. (2002). *Tarihsel süreçte Batı Anadolu'da yerel kültürlerin tuvalet ve banyo alışkanlıklarının incelenmesi* Ms Thesis. University of Dokuz Eylül.

_____. (2002). *Türkiye'de seramik: toprakla ateşin öyküsü: Neolitik Çağ'dan bugüne çömlekçi tezgahından dev bir endüstriye seramigin Anadolu'daki 8000 yılı*. İstanbul. Seramik Tanıtım Komitesi.

Trupia, Zeynep. (2007). *The Effects of World War II on Italian Design: Architect Designers*. Retrieved from www.design-nero.com/makale01.pdf

Urso, L. C. (2000). *Patent No. 6148448*. United States. Google Patents.

Varlık, G. (2008). Yapay zekâsından MP3 çâlarısına kadar artık teknoloji klozetlerde. *Referans İş Gazetesi*. Retrieved March 3, 2008, from www.referansgazetesi.com/haber.aspx?HBR_KOD=88530

_____, (n. d). Vitra Bathroom Culture. Retrieved October 3, 2008, from Vitra Web Site: www.vitra.com.tr

Weidl, F. (1908). *Patent no. 901,134*. United States. Google patents.

Wenz-Gahler, I. (2005). *Flush!: Modern toilet design*. Boston: Birkhauser.

Winblad, U., Kilama, W., and Torstensson, K. (1978). *Sanitation without water*. Stockholm: Sundt Offset.

_____, (n. d.). *World's oldest sewer system found in Van*. Retrieved February 3, 2008 www.ntvmsnbc.com/news/283730.asp?cp1=1#BODY

Wright, L. (1960). *Clean and decent*. New York: Viking Press.

Yılmaz, B. (2006). *Ceramic Industry*. Ankara. Export Promotion Center of Turkey (IGEME).

APPENDIX A

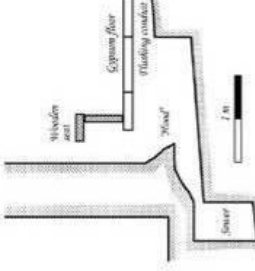
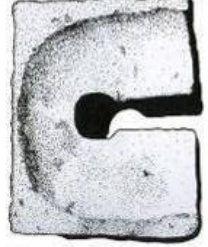
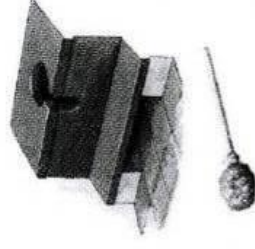

8000 BC	3000 BC	2000 BC	1370 BC	800 BC
<p>According to remains, in Scotland there were plumbing pipes. (Eagan and Gruber, 2008)</p>	<p>The early toilets were first seen in Mesopotamia. 3000 B.C. in by the King of Akkad, Sargon, I. The toilets were shaped like a keyhole and the waste was drained into a portable pot under the toilet. (Horan, 1997)</p>	 <p>Archeologists discovered toilets in Crete from 2000 B.C, the oldest known water-flushing toilets that used rainwater, similar to the today's water-flushing toilets. (Angelakisa and et al, 2004)</p>	 <p>There were findings from 1370 BC that suggested that there were bathrooms with water cups to wash hands. A toilet with limestone seat, built inside the bathroom closet of a house that belonged to a high-ranking official, was found in Tell-el-Amarna, Egypt from 14th century BC. (Wright, 2005)</p>	 <p>There was a hole in the bottom where the waste fell. The toilet could be flushed by pouring water into the opening in the front, and cleaned with tools (Gülbay, 2003)</p>

Eagan, S. C., & Gruber, P. R. (2008, October 23). Retrieved April 26, 2008, from *West Virginia University* Web site: <http://www.wvu.edu/>

Horan, J. L. (1997). *The Porcelain God: a Social History of the Toilet*. Citadel Press.

Angelakisa, A.N., Koutsoyiannis, D., Tchobanoglous, G. (2005). Urban wastewater and stormwater technologies in ancient Greece. *Water Research*, 39, 210-220. Elsevier.

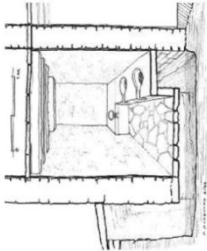
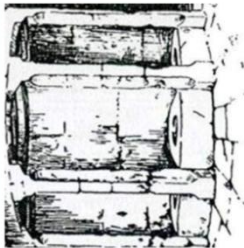
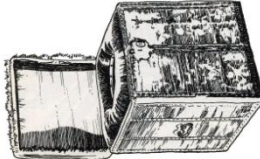
Cooper, P. F. (2001). *Historical Aspects of Wastewater treatment. In Decentralised Sanitation and Reuse: Concepts, Systems and Implementation* (pp. 11-39). London: IWA Publishing.

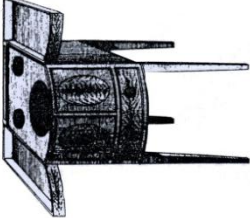
800 BC	1189 AD	1600 AD	1670 AD	1754 AD
 <p>The Ancient Greeks (300 BC to 500 AD) took a different approach from other civilizations of the time in dealing with the waste and wastewater. They used the wastewater for irrigation and to fertilize crops and orchards (Cooper 2001).</p>	 <p>An alternative to the chamber pots was “garderobe” that was a small private toilet built into castle walls starting in 1189 in London. They had stone or wooden seats. Some of the garderobes built for two or three people. (Wright, 1960; Wenz-Gahler, 2005)</p>	 <p>The factors affecting chamber pot and close stool designs were: comfort, visually esthetical, material that varied with respect to status. In order to provide softer and comfortable seat different types of cloth were used. (Horan, 1997).</p>	 <p>1670 The chamber pot of James I, King of Scotland was made up of silver. (Mattelaer, 1999)</p>	 <p>Bason Stand by Chippendale (Wright, 1960).</p>



Cooper, P. F. (2001). Historical Aspects of Wastewater treatment. In *Decentralised Sanitation and Reuse: Concepts, Systems and Implementation* (pp. 11-39). London: IWA Publishing.

Wright, L. (1960). *Clean and decent*. New York: Viking Press.



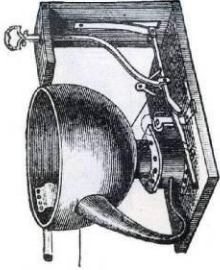
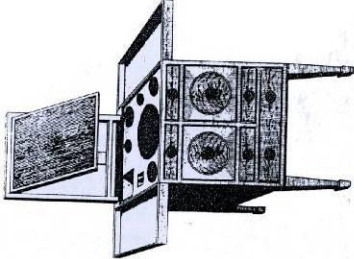

Wenz-Gahler, I. (2005). *Flush!: Modern toilet design*. Boston: Birkhauser.

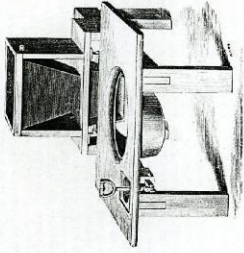
Horan, J. L. (1997). *The Porcelain God: a Social History of the Toilet*. Citadel Press.



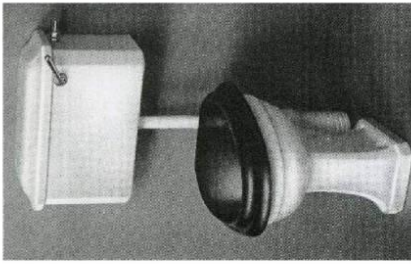

Mattelaer, J. (1999). Some historical aspects of urinals and urine receptacles. *World Journal of Urology* 17-3, 145-150.

<p>1775 AD</p>		<p>Alexander Cumming invented the water trap that sits under the bowl and between the toilet and sewer <i>blocking</i> the odors to diffuse into the house. (Wright, 1960)</p>
<p>1778 AD</p>		<p>Braham's Valve Closet, 1778 (Wright, 1960) Braham's design was very popular because of its effective outlet seal (Blair, 2000).</p>
<p>1787 AD</p>		<p>Shaving Table by Hepplewhite. (Wright, 1960)</p>
<p>1809 AD</p>		<p>Twyford 1809 earthenware pan closet. (Blair, 2000)</p>
<p>1860 AD</p>		<p>Henry Moule invented "earth closet" in 1860. It removed the necessity for cesspools. The removal of the cesspools from the toilet designs was important because cesspools carried the risk of contaminating the drinking water (Wright, 1960).</p>

Wright, L. (1960). *Clean and decent*. New York: Viking Press
Blair, M. (2000). *Ceramic Water Closets*. Buckinghamshire. Shire Publications.

<p>1898 AD</p>		<p>A cistern flushing valve and its mechanism. (Blair, 2000)</p>
<p>1910 AD</p>		<p>The 1876 plunger closet. One piece form. (Blair, 2000)</p>
<p>1912 AD</p>		<p>1882 Portable Water closets "with pump and copper pail" (Wright, 1960)</p>
<p>1929 AD</p>		<p>Thomas Tywford, one piece closet. (Blair, 2000)</p>
<p>1930 AD</p>		<p>Tyford 1898 catalogue, Victorean period style toilets. (Blair, 2000)</p>

Blair, M. (2000). Ceramic Water Closets. Buckinghamshire. Shire Publications.

1950 AD	1953 AD	1980 AD	1994 AD	2000 AD
 <p>In 1950s, after the discovery of plastics, toilet seats were made of plastics. The advantage of the plastic material was that it was very light; hence, the cover of the toilet seat was easy to open (Hauffe, 1996).</p>	 <p>Gio Ponti's toilet design (Marcus, 1998) The toilet design made of vitreous china, made by Gio Ponti in 1953 for Ideal Standard is exhibited in Philadelphia Museum of Art, a gift from Ideal Standard (Marcus, 1998)</p>	 <p>In 1980 the designers at Caroma developed DuoSet toilet that reduced the usage of flushing water by half in response to Australia's limited water resources. ("DuoSet dual,"2008)</p>	 <p>Efficiency toilets. Manufacturing companies are developing high efficiency toilets that consume less water while keeping their high standards on hygiene and comfort (Várlık, 2008).</p>	 <p>The smaller tank of water capacity 3. 5 liters and larger one of water capacity 6 liters, and there are two buttons to provide two-step flushing function.</p>

Blair, M. (2000). Ceramic Water Closets. Buckinghamshire. Shire Publications.

Marcus, G. H. (1998). *Design in the fifties: when everyone went modern*. Munich: New York: Prestel.

Várlık, G. (2008). Yapay zekâsından MP3 çârlâsına kadar artık teknoloji klozetlerde. *Refans İş Gazetesi*. Retrieved March 3, 2008, from www.referansgazetesi.com/haber.aspx?HBR_KOD=88530