

PROPOSAL FOR A NON-DIMENSIONAL PARAMETRIC INTERFACE DESIGN IN
ARCHITECTURE: A BIOMIMETIC APPROACH

A THESIS SUBMITTED TO
THE GRADUATE SCHOOL OF NATURAL AND APPLIED SCIENCES
OF
MIDDLE EAST TECHNICAL UNIVERSITY

BY

SEMRA ARSLAN SELÇUK

IN PARTIAL FULFILLMENT OF THE REQUIREMENTS
FOR
THE DEGREE OF DOCTOR OF PHILOSOPHY
IN
BUILDING SCIENCE IN ARCHITECTURE

FEBRUARY 2009

Approval of the thesis:

**A PROPOSAL FOR A NON-DIMENSIONAL PARAMETRIC INTERFACE DESIGN
IN ARCHITECTURE: A BIOMETRIC APPROACH**

submitted by **SEMRA ARSLAN SELÇUK** in partial fulfillment of the requirements for
the degree of **Doctor of Philosophy in Building Science in Architecture, Middle
East Technical University** by,

Prof. Dr. Canan Özgen
Dean, Graduate School of **Natural and Applied Sciences**

Assoc. Prof. Dr. Arif Güven Sargin
Head of Department, **Architecture**

Asst. Prof. Dr. Arzu Gönenç Sorguç
Supervisor, **Architecture, METU**

Examining Committee Members :

Assoc. Prof. Dr. Abdi Güzer
Department of Architecture, METU

Assist. Prof. Dr. Arzu Gönenç Sorguç
Department of Architecture, METU

Assist. Prof. Dr. Mine Özkâr
Department of Architecture, METU

Assoc. Prof. Dr. Caner Durucan
Dep. of Metallurgical and Materials Engineering, METU

Assist. Prof. Dr. Tayfun Yıldırım
Department of Architecture, GU

Date : 13.02.2009

I hereby declare that all information in this thesis document has been obtained and presented in accordance with academic rules and ethical conduct. I also declare that, as required by these rules and conduct, I have fully cited and referenced all material and results that are not original to this work.

Name, Last name: Semra Arslan Selçuk

Signature:

ABSTRACT

PROPOSAL FOR A NON-DIMENSIONAL PARAMETRIC INTERFACE DESIGN IN ARCHITECTURE: A BIOMIMETIC APPROACH

Arslan Selçuk, Semra

Ph.D., Department of Architecture

Supervisor: Asst. Prof. Dr. Arzu Gönenç Sorguç

February 2009, 171 pages

Biomimesis, the imitation of animate and inanimate forms in nature to inspire new designs, is a term introduced in the 20th century. The concept that there exist models and solutions in nature that may improve and optimize the way mankind lives has been the subject of much discussion. Although biomimesis as a well-defined discipline is a relatively recent concept, modeling nature is as old as mankind itself and can be seen in many different forms in all aspects of life.

In the field of architecture there have been several designs created by imitating/modeling or aspiring to forms in nature. Most of the “end products” of these processes can be considered as milestones in the history of architecture, with their innovative form, structure, and construction techniques, and have resulted in developments in many fields through the pioneering of new and successful designs.

The implementations of the concept of Biomimesis in the field of architecture are mostly observed in the design of forms. In the proposed study, besides those forms, structural behavior and the optimized response to internal and external loads of these forms, together with their geometrical configurations, have been studied to provide a methodology to understand relationships in nature for optimized structures and in the further steps a system design has been aimed.

Within the framework of methodology, in the first part of the study, form/structure groups in animate and inanimate nature are classified and their representative characteristics are discussed. The next part focuses on the “shell”, as a case to exemplify the proposed methodology. For this reason, the “seashell” form is chosen to explore the forms/structures in architecture. For this purpose, initially the definitions of a shell and its implementations in architecture have been examined and the “real problem” has been described: what are the codes in architecture to understand the language of shells in nature and how this knowledge can be translated to man made design.

The modeling approaches of the researchers working on the seashells have been examined and parameters developed to generate a mathematical model closer to a real shell. A program has been written to generate the computational model of selected seashell Turitella Terebra as a case. Through a series of abstractions/assumptions first mathematical then computational model of the actual seashell have been obtained to explore the behavioral properties of shells. In the experimental part of the study, 86 shells have been exposed to compression tests, similar boundary conditions and loads have been applied to the computational model in two different FEA software, to compare simulation results with the experimental ones in order to check the precision and efficacy of the computational model. The results have been analyzed and a number of non-dimensional parameters are obtained. It is believed that potential relations in the realm of architecture regarding such non dimensional parameters would be a new era to talk new design methods and to construct optimized structures. Through this perception/thinking/designing/manufacturing method a platform would be formed to discuss the concept of Biomimesis in architecture subjectively.

Keywords: Biomimesis in architecture, shell design, design algorithm, seashell

ÖZ

MİMARLIKTA BOYUTSUZ BİR PARAMETRİK ARAYÜZ TASARIMI İÇİN ÖNERİ: BİYOMİMETİK YAKLAŞIM

Arslan Selçuk, Semra

Doktora, Mimarlık Bölümü

Tezyöneticisi: Yrd. Doç. Dr. Arzu Gönenç Sorguç

Şubat 2009, 171 sayfa

Biyomimesis, canlı cansız varlıkların taklit edilerek yeni tasarımlara ilham kaynağı olması kavramı, 20.yüzyılın sonunda literatüre girmiş ve insanın varolma biçimini en iyileyecek her modelin ve çözümü doğada olduğu düşünme biçimi sistematik bir biçimde tartışılmaya başlamıştır. Biomimesis tanımlı bir disiplin olarak 20. yüzyılın bir ürünü olmakla beraber, doğanın bir model olarak alınması insanoğlunun varoluşundan buyana ortaya koyduğu ürünlerde farklı boyutlarda ortaya çıkmaktadır.

Literatürde, mimarlık alanında doğanın taklit edilmesiyle/modellenmesiyle yada tasarımın temel ilham kaynağı olmasıyla ortaya çıkmış birçok tasarım bulunmaktadır. Bu “son ürünlerin” pek çoğu mimarlık tarihine, öncül ve yenilikçi form strüktür ve yapım teknikleri ile başyapıtlar olarak girmiştir ve disiplinler arası pek çok yeni ve başarılı tasarımlara öncülük etmiştir.

Biomimesis kavramının mimarlık alanına yansıma biçimi çoğunlukla formun oluşturulması sürecinde gözlemlenmektedir. Önerilen bu çalışmada ise form dışında, strüktür, formun içsel ve dışsal yüklerle en az malzeme ile en iyi biçimde dayanımını sağlayan matematiksel oranlarla da ele alınarak, eniyilenmiş form-strüktür tasarımlarında doğanın model olarak alınmasında bir metodoloji geliştirilmiştir ve ilerleyen aşamalarda ise bir sistem tasarımı hedeflenmiştir.

Bu metodoloji çerçevesinde, çalışmanın ilk aşamasında canlı yada cansız doğada bulunan form-strüktür grupları sınıflandırılmış ve bu temel grupların belirleyici strüktürel özellikleri irdelenmiştir. Bunu izleyen aşamada önerilen metodobjinin “ömeklenmesi” için “kabuk” formuna odaklanılmıştır. Bu amaçla “deniz kabuğunun” mimaride yeni form ve strüktür arayışlarında getireceği kazanımlar sorgulanmıştır. Bu sorgulamada öncelikle strüktürel ve formsal olarak “kabuk” tanımı ve mimarideki günümüze kadar olan yansımaları incelenmiş ve “gerçek problem” tanımlanmıştır: doğadaki kabuk bilgisi mimarlıktaki dilini nasıl bulabilir ve bu bilgi nasıl aktarılır.

Deniz kabuğu konusunda çalışmalar yapan araştırmacıların modelleme yaklaşımları incelenmiş ve gerçek kabuğa en yakın modeli oluşturacak parametreler geliştirilmiştir. Ömekleme için seçilen Turitella Terebra cinsi deniz kabuğunun matematiksel modelini sayısal ortama aktaran bir program yazılmıştır. Kabukların davranışsal özelliklerinin anlaşılabilmesi için çeşitli varsayımlar yapılarak hem gerçek kabuklar hem de model testler için hazırlanmıştır. 86 deniz kabuğu çeşitli işlemlerden sonra basınç testlerinden geçirilmiş aynı testler sayısal/hesaplama model üzerinde de, sonlu elemanlar analiz yöntemi ile hesaplama yapan iki yazılımla gerçekleştirilmiştir. Sonuçlar değerlendirilmiş ve bir dizi boyutsuz parametre elde edilmiştir. Bu parametreler üzerinden kurulabilecek potansiyel ilişkilerin mimarlık alanında yeni sözler söylemek, yeni tasarım metotlarını konuşabilmek ve eniyelenmiş strüktürler kurmak için bir başlangıç oluşturacağı düşünülmektedir. Bu algılama/düşünme/tasarlama/üretme yöntemi ile mimarlıkta “Biyomimesis” kavramının nesnel olarak tartışılabileceği disiplinler arası bir platformun kurulabileceğine inanılmaktadır.

Anahtar kelimeler: Mimarlıkta Biomimesis, boyutsuz parametreler, kabuk tasarımı, eğrisellik, algoritma, deniz kabukları.

To My Parents,

Emine and Osman ARSLAN

ACKNOWLEDGMENTS

I would like to express my sincere gratitude and deep appreciation to my supervisor Asst. Prof. Dr. Arzu Gönenç Sorguç not only for her guidance, valuable suggestions, comments and continuous support throughout this research but also her encouragement and patience in developing my academic attitude. Thank you...

Great appreciation to the jury members Assoc. Prof. Dr. Abdi Güzer, Assoc. Prof. Dr. Caner Durucan, Asst. Prof. Dr. Mine Özkâr and Asst. Prof. Dr. Tayfun Yıldırım.

Special thanks to Dr. Chris Williams for his guidance, support and hospitality during my research in the University of Bath, England and thanks to Prof. Dr. Julian Vincent who provide me giving a seminar to share my experiences and knowledge with the colleagues from Biomimetic Research Centre in the same University. I also express my thanks to my colleague Alex for his help in the program writing process of the study. For the technical part of the simulations I am thankful to Murat Sorguç and Ömer Öztan from TAI.

Also, special thanks to Türkiye Çimento Müstahsilleri Birliđi, who awarded my PhD research with "İz Bırakanlar" Scholarship for 2 years (2005-2007).

I am forever indebted to my lovely mother Emine Arslan, my beloved father Osman Arslan, my darling sister Sema Akdemir and my dearest brother Ömer Arslan for their encouragement, trust and self-sacrifice throughout all my life and I am sincerely thankful to them for always believing in me. My gratitude can never be enough. Thank you...

I would like to express my deepest appreciation to my husband Mustafa, for being always with me, his unshakeable faith in me and his endless support, patience, love and friendship. He always shared my excitements and enthusiasm. Thank you...and finally... to Zeynep Nur... my lovely baby deserves more than gratefulness with her existence in my life. Without her inspiration and love I could have not finished this study. Thank you my sweetheart...

TABLE OF CONTENTS

ABSTRACT	iv
ÖZ.....	vi
ACKNOWLEDGMENTS.....	ix
TABLE OF CONTENTS	ix
LIST OF TABLES.....	xiii
LIST OF FIGURES.....	xiii

CHAPTER

1. INTRODUCTION.....	1
1.1 Argument.....	1
1.2 Objectives and Scope	3
1.3 Procedure	4
1.4 Disposition	7
2. LITERATURE SURVEY	8
2.1 The concept of Biomimesis.....	9
2.1.1 Why and How Biomimesis Works.....	11
2.2 Nature-Architecture Relationship.....	15
2.2.1 Observation of Prior Periods.....	15
2.2.2 Architectural Trends Inspired from Nature in 20 th Century.....	18
2.2.3 Inspirations from Nature in Contemporary Architecture.....	25
3. THEORIES AND POSTULATE	32
3.1 Biomimesis in Architecture.....	33
3.1.2 Biomimesis in Architecture: Relationship among Nature- Structure- Architecture	34
3.1.2.1 Classification of Structures in Nature	35
3.1.2.2 General Taxonomy of Architectural Structures Inspired by Nature ..	37
3.1.1.2.1 Tree -Like Structures.....	39

3.1.1.2.2 Skeleton-Like Structures.....	41
3.1.1.2.3 Web-Like Structures.....	43
3.1.1.2.4 Pneumatic Structures.....	45
3.1.1.2.5 Shell-Like Structures.....	47
3.2 Contemporary Biomimetic Approach in Architecture: A Case on Shell.....	51
3.2.1 Definitions on Natural and Man-Made Shells.....	52
3.2.2 The Origins of Man-Made Shells.....	54
3.2.3 Basic Structural Properties of Shells and Their Use in Architectural Applications.....	55
3.2.4 Experimental Shell Structures and Shell Builders of the 20 th Century.....	58
3.2.4.1 Pioneering Examples.....	60
3.2.5 Present Techniques in the Analysis of Shell Structures.....	66
3.3 Concluding Remarks of Chapter3.....	70
4. MATERIALS AND METHODOLOGY.....	72
4.1 Materials.....	73
4.2 Methodology.....	74
5. CASE STUDY: (RE)DISCOVERING (SEA)SHELL ARCHITECTURE.....	76
5.1 Observation of Shell Forms Inspired from Nature.....	77
5.1.1 Interpretations of Different Seashell Forms and Spirals in Art and Architecture throughout History.....	79
5.2 Analysis of Seashells and Seashell Geometry.....	87
5.2.1 Mathematical Studies on Seashell Geometry.....	88
5.2.2 Modeling Approaches on Seashell Geometry.....	90
5.3 Computational Model Developed for the Coiled Seashells.....	93
5.3.1. Mathematical Analysis of the Selected Seashell: Turitella Terebra.....	97
5.3.2 Mathematical Model of Turitella Terebra.....	99
5.4 Behavioral Analysis of Seashell(s).....	108
5.4.1 Analytic and Numerical Properties of Turitella Terebra According to Basic Shell Theories.....	109
5.4.2 Physical Compression Tests on Turitella Terebra.....	111
5.4.2.1 Preparation of Samples for Compression Tests.....	114
5.4.2.2 Results.....	124

5.4.3 Finite Element Analysis of Computational Model.....	125
5.4.3.1 Preparation of Digital Model for FEA.....	126
5.4.3.2 Specifying Material Properties, Loads and Boundary Conditions...	128
5.4.3.3 Results	131
5.5 Synthesis: Introduction to Non-Dimensional Parameters	134
6. DISCUSSIONS AND CONCLUSIONS.....	140
6.1 Conclusions.....	140
6.2 Introducing Non-Dimensional Parameters as a Base for Learning from Nature	143
6.3 Recommendations for Future Studies.....	149
REFERENCES.....	151
APPENDIX	
A. SEASHELLS AND TERMINOLOGY OF CONCHOLOGY	162
B. DEVELOPMENTS IN BIOLOGY AND ARCHITECTURE	162
CURRICULUM VITAE.....	168

LIST OF TABLES

Table 2.1 Timeline representing Biomimetic studies and resulted innovations.....	14
Table 2.2 Changing paradigm in nature architecture relationship	31
Table 3.1 Diagram representing architectural structures inspired by nature	50
Table 5.1 Coefficients found in the vertical section of Turitella Terebra.....	99
Table 5.2 Base, height and whorl numbers of each specimen	113
Table 5.3 Dimensions and test results of sample ID109.....	116
Table 5.4 Dimensions and test results of sample ID40	118
Table 5.5 Dimensions and test results of sample ID-115.....	120
Table 5.6 Numeric values of base, height, weight, whorl numbers, time for failure, load and stroke for 43 samples (part 1).....	122
Table 5.7 Numeric values of base, height, weight, whorl numbers, time for failure, load and stroke for 43 samples (part 2).....	123
Table 5.7 Typical physical properties of Calcium Carbonates.....	129
Table 5. 8 Representing base-height ratio range to load	135
Table 5. 9 Representing base-height ratio range to load relation for the “a” parts of the sample space	135
Table 5. 10 Representing weight to load relation for the “a” parts of the sample space	135
Table 5. 11 Representing increasing whorl number to load for the “a” parts of the sample space	136
Table 5. 12 Representing base-height ratio range to load relation for the “b” parts of the sample space	136
Table 5. 13 Representing weight to load relation for the “b” parts of the sample space	136
Table 5. 14 Representing increasing whorl number to load for the “b” parts of the sample space	136
Table 5. 15 Diameter to height ratios of some important dome structures.....	136
Table B. 1 Timeline representing developments in biology and architecture	136

LIST OF FIGURES

Figure 2.1 Images from different regions inspired by natural forms	16
Figure 2.2 Examples from Antoni Gaudi.....	19
Figure 2.3 Exhibition building in Turin and Small Stadium in Rome	21
Figure 2.4 Studies from Frei Otto	23
Figure 2.5 Table of architectural concepts by Jencks	24
Figure 2.6 Section and view from the African termite towers and the Eastgate building.....	27
Figure 2.7 View from Eden Project.....	28
Figure 2.8 Lotus effect.....	29
Figure 3.1 Examples from inanimate nature.....	35
Figure 3.2 Images from animate nature	36
Figure 3.3 Branching theory of Frei Otto.....	40
Figure 3.4 Examples from Calatrava's tree-like structures.....	41
Figure 3.5 Examples from contemporary tree-like structures.....	41
Figure 3.6 Images from skeleton-like structures Eiffel tower and femur, Casa Battlo, Waterloo Station.....	43
Figure 3.7 Web-like structures in nature and architecture	44
Figure 3.8 Montgolfier Brothers' hot air balloon	45
Figure 3.9 Tokyo Big-Egg Dome	47
Figure 3.10 Archipelago.....	47
Figure 3.11 Shell examples from nature and architecture	48
Figure 3.12 Behavior of barrel shells.....	56
Figure 3.13 Three basic shapes of conoidal shells.....	57
Figure 3.14 Examples from cantilevered shells.....	57
Figure 3.15 Examples from hypars in architecture.....	58
Figure 3.16 The dome of Palazzetto dello Sport, Rome by Nervi.....	62
Figure 3.17 The shell of Los Manantiales Restaurant.....	64
Figure 3.18 TWA Flight Center and Kresge Auditorium, MIT	65
Figure 3.19 The roof of Centre National d'Industries et Technologies by Prouve....	66
Figure 3.20 Axial and shear forces in the shell element under axial load.....	69

Figure 3.21 Axial and shear forces in the shell element under axial load.....	70
Figure 5.1 Simplified computation cycle for learning from nature.....	77
Figure 5.2 The Birth of Venus, Sandro Botticelli.....	80
Figure 5.3 Seashell abstractions by Leonardo da Vinci.....	80
Figure 5.4 Seashells in modern painting.....	81
Figure 5.5 Seashells and columns.....	82
Figure 5.6 Spirals and staircases.....	83
Figure 5.7 Examples from seashells in architecture.....	83
Figure 5.8 Inner and outer spaces of Guggenheim Museum by Frank Lloyd Wright.....	84
Figure 5.9 Shells of Sydney Opera by John Utzon.....	85
Figure 5.10 Inner and outer spaces of Community of Christ by HOK.....	86
Figure 5.11 Sage Gateshead cultural center by Foster.....	86
Figure 5.12 Experimental shell architecture.....	87
Figure 5.13 Shell parts.....	89
Figure 5.14 X-Ray view of a shell and its logarithmic spiral.....	90
Figure 5.15 Seashell modeling parameters by Thompson.....	91
Figure 5.16 The parameters controls shell geometry.....	92
Figure 5.17 3D spiral in Cartesian coordinate and polar coordinate systems.....	94
Figure 5.18 Proposed seashell parameters.....	95
Figure 5.19 Abstracted seashell models developed by the author.....	96
Figure 5.20 Abstracted seashell models developed by the author.....	96
Figure 5.21 Cut cross-sections of a selection of seashells found in nature.....	97
Figure 5.22 Geometrical analysis of the vertical section of.....	98
Figure 5.23 A typical B-spline and its control polygon.....	100
Figure 5.24 The outermost surface of the shell.....	100
Figure 5.25 The points controlling of generating curve from scanned cut shell.....	101
Figure 5.26 Geometry of the logarithmic spiral.....	102
Figure 5.27 Construction of the shell surface.....	102
Figure 5.28 Geometric relations of the shell surface.....	104
Figure 5.29 Scan of the seashell found in nature (left) computer generated shell model (right) by the algorithm developed for this research.....	105
Figure 5.30 Demonstration of the flexibility of the program to experience different coiled seashell forms.....	105
Figure 5.31 Structural analysis of Turitella Terebra according to shell theories.....	110

Figure 5.32 A sample space of 150 Turitella Terebra	112
Figure 5.33 Measurements with a digital compass.	112
Figure 5.34 Typical cut lines of a Turitella Terebra	114
Figure 5.35 Figure representing a-b-c parts of cut shells.....	115
Figure 5.36 Sample ID109 cut shell.....	116
Figure 5.37 Sample ID109 tested shell	116
Figure 5.38 Failure graphics of sample ID109a and ID109b	117
Figure 5.39 Sample ID140 cut shell.....	118
Figure 5.40 Sample ID140 tested shell	118
Figure 5.41 Failure graphics of sample ID140a and ID140b	119
Figure 5.42 Sample ID115 cut shell.....	120
Figure 5.43 Sample ID115 tested shell	120
Figure 5.44 Failure graphics of sample ID115a and ID115b	121
Figure 5.45 Weibull statistics of tested shells.....	124
Figure 5.46 Typical cut parts of the computational model for FEA.....	127
Figure 5.47 Requirements of FEA process to be followed.....	128
Figure 5.48 Loading conditions of SAP2000 model.....	130
Figure 5.49 The revised geometry with the supports and type of joint restraints of SAP2000 model.	131
Figure 5.50 Graphics showing failure in a real shell and Von Mises Shell Stress diagram of Sap2000 and Patran	132
Figure 5.51 Graphical result of Resultant Von Mises Forces diagram of Sap2000	133
Figure 5.52 Graphical result of displacement diagram of Patran.....	133
Figure 5.53 Demonstration of the working base to height ratio relation with loading on a tapered cone	133
Figure 6.1 Proposed methodology for learning from nature a case on seashells: Biomimesis in architecture	164
Figure A.1 Representative examples of chiton and tusk shell	164
Figure A.2 Representative examples of bivalve and chambered nautilus.....	164
Figure A.3 Some representative examples from Class Gastropoda.....	165

CHAPTER 1

INTRODUCTION

In this chapter the arguments and the objectives of the study are presented, followed by an overview of the general procedure and outlines of the remaining chapters under the sub-heading “disposition”.

1.1 Argument

Man has learned a great deal through the observation of natural structures, in both inanimate and animate forms, which exhibit optimized features in terms of their structure, material, diverse form, and their response to different climatic/environmental conditions. Although several structures have come about through the modeling/imitation/implementation of structures in nature, such as tent structures, drawing influence from soap films and spider's webs, and Fuller's geodesic domes or panel structures from honeycombs, the number of researches focusing on the potentiality of “learning from nature” to propose new innovative designs are still very limited.

The concept studied in this thesis is known as “biomimesis in architecture”. When forms in nature are studied it can be seen that these forms are manifestations of the phenomena of forces. These forces shape the forms and structures, which simply, economically, and efficiently express the internal and external forces influencing them. However, it may be difficult to recognize that the forms/structures in nature have evolved to attain an equilibrium state, either in static or dynamic cases. An analysis of structures and their behaviors found in nature is essential to provoke new designs. These forms and their structural systems can be classified into five main categories according to their shapes and inherited structures: tree-like structures, skeleton-like structures, shell-like structures, web-like structures, and pneumatic structures, all of which are explained and clarified through examples in the following chapters.

It can be argued that natural structures and systems are efficient regarding their use of materials, lightness, rigidity and stability; and it is no surprise that they offer great lessons for designers looking to emulate their efficiency and sustainability. In most cases the complexity of forms in nature avoids the clear identification of structural systems that provide the conditions for equilibrium. Yet, as the computational techniques and new methods to analyze dynamic and static behavior improve, more and more interest is placed on these forms, and even complicated structural behaviors can be modeled successfully.

Contemporary studies have shown that although the impact of biomimesis in architecture becomes stronger in broader examples still there is need for a systematic approach. Therefore in this thesis it is aimed to provide a systematic and then a system design to analyze these complex structures, to “learn” from them, and to propose new fields of implementations in architecture as it is in other disciplines that have their own methods. Shells, specifically seashells, are chosen as the subject of interest to fulfill this argument. Shells in nature are very common due to their potential to provide shelter, their minimum material requirements, and their rigidity. At first glance seashells are complex structures, but their forms and structures can be explained using a few mathematical relations. The close harmony that exists in seashells as regards to structural behavior, form, function, and material has led to a number of researches to look deeper into their material properties. Similarly, man made shells are highly effective structures with respect to their large span capacity with minimum material usage. Although domes and vaults have been around for centuries, in general, shells are a product of the 20th century, with development being closely related with the advancement of numerical analysis techniques, materials, and constructional technology; however, since the 1960s this rapid development in the design and production of shells has all but stopped. There is no single reason that accounts for the demise in the construction of shell structures; rather, it is a result of many factors. It is believed that learning from seashells will be a new expansion that may be known as the “biomimetic revolution of shells”.

1.2 Objectives and Scope

Seashells are one of the most interesting natural forms in terms of showing how nature has developed sophisticated forms. A number of studies have already been carried out into seashells, which have helped man to understand their material properties and growth characteristics. It is seen that the seashell form is suitable for the requirements of minimum energy as well as in response to the action of forces in the environment. Thompson claims that seashells display a great diversity of forms from a basic natural principle, "Form as a diagram of forces" (Thompson, 1992).

In this study, seashell forms are employed to question structures in nature and their implementations in architecture and engineering. The link between nature and architecture is usually built upon one of two major approaches: the architectural form that is inspired by nature; and the development of a natural form applied directly into an architectural form by considering the "process" of nature and its behavioral and generative properties. The majority of architectural researchers and designers tend to follow the first category, while this research looks at architectural form generation based on the abstracted seashell geometry and a possible structural system analysis of those forms. The intention of this research is to inspire more interest in the analysis of natural forms through the integration of architecture and technology into the example of "seashells" and their "implementations in architecture".

It is aimed to illustrate the close relationship between form, structure, and proportion, besides material properties and environmental conditions, to address the stability problem using minimized energy and material consumption, as is observed in nature. It is also aimed to provide a systematic method in the analysis to propose new structural systems and their parameters.

The main objectives of this study are:

- a) to explore the potential of Biomimesis and its implementations in different disciplines, like engineering, medicine, agriculture etc.

- b) to explore and structure relationships between nature and architecture.
- c) to clarify what is meant by “Biomimesis in architecture”, as a learning means from nature.
- d) to identify the structural properties of architectural examples inspired by nature, to classify them, and to choose one to exemplify the hypothesis of this study.
- e) to propose a method to understand and discuss “Biomimesis in architecture”
- f) to propose a non-dimensional parametric interface between natural structures and architectural structures through shell case.

1.3 Procedure

The study was conducted in seven phases;

First, a literature survey was conducted in order to define the research problem, to understand the nature of Biomimicry, and to see how features in nature have been interpreted by architects throughout history. Additionally, a literature survey on how Biomimetic innovations have been actualized in other disciplines was conducted.

Second, it was seen that the applications in architecture inspired from nature consisted of either form finding concerns and decorative intents or inspirations for ways of natural HVAC. In this study it was intended to reveal that although architects have borrowed ideas from nature in the design of their forms and structures throughout history, Biomimesis can serve architecture with all its potentials to propose new and innovative solutions. Biomimesis can be applied for form, structural systems, and even systems for environmentally friendly kinematic/static/deployable structures, mirroring those found in nature with the help of methodologies to be developed specifically for architectural design. Developing technologies in observation and computation allow researchers to learn more from nature, however it can be seen that current implementations far from follow the real meaning of biomimesis.

Third, it is concluded that Biomimesis in architecture should be taken into account after reconsidering both the developments in science and technology and the

evolution of other disciplines inspired by nature. Although most of the studies in other disciplines have developed specific methodologies to embed Biomimetic elements into their research areas in an objective way, architecture is still in its infancy in experiencing “form-creation processes”, and is mostly conceived as the inclusion of the use of computers and solid modeling interfaces as design tools in the light of examples from different disciplines. Hence, Biomimesis can be a “learning interface”, having its own systematic with objective design parameters to propose new design paradigms for architecture. For this reason, a set of architectural examples inspired by nature are listed according to architectural period, function, and structure. These are classified under five headings according to their structural behavior: tree-like, web-like, skeleton-like, pneumatics, and shells, and the kinetic properties of all were examined.

Shells are encountered very frequently in both natural and man-made structures due to their high structural performance and potential to offer shelter in both natural organisms and man-made structures. Furthermore, the natural shell, which has always been a subject of interest for architects as regards form, function, structural behavior, and material, is very useful in allowing an understanding of the “multi-dimensional” properties of nature and natural processes in the formation of the final configuration of the structures. For this reason shell structures were chosen to exemplify the hypothesis of this study. In this stage also the “methodology” constructed to be followed.

Fourth, from the natural shells, seashells, and among them coiled shells were selected. A brief Conchology search was carried out, in the case of this thesis Turitella Terebra was selected to understand the form-function-structure and material properties of a natural object. After a literature survey on seashells in architecture it was seen that the seashell form remains as a subject of interest that is very frequently used in architecture. For the purpose of this study, 150 Turitella Terebra were ordered from Miami, USA, and were photographed and documented according to a number of geometric features. As the understanding of the shell form cannot be easily understood using Cartesian coordinates alone, some of the samples were cut vertically and horizontally in order to expose their entire 3D

properties. Using the gathered data and parameters a program was written and a digital model created. For this purpose, a research was conducted at the University of Bath in the UK from June to September 2005¹. The research included studies on shell theory and the writing of a mathematical model of a selected seashell (Turitella Terebra) in a c++ compiler. Furthermore, recent studies and researches into Biomimesis were observed to provide a clear understanding of Biomimesis².

Fifth, a group of tests were planned and were applied to all 150 specimens³. Due to their unconventional forms, the shells needed to be cut in order to allow testing with conventional compression test machines. Once cut, the shells were again photographed and documented to record their new geometric features. The data gathered from these tests was tabulated to understand the variations in the cracks sustained during the compression tests in relation to the geometric features of each shell. All the accumulated data was used to draw up statistical graphs, and the results were discussed.

Sixth, the same loads and boundary conditions are implemented on the computational model to verify the results and to understand the behavior of shells, either the ones examined or the ones abstracted or derived by them.. A set of non-dimensional parameters were defined to understand the relationship between form-structure-geometry. A series of man made shells were then designed according to these parameters and the reasons and possible outcomes of using non dimensional parameters were discussed.

In the last chapter, conclusions derived from the research, and recommendations and suggestions for future studies were presented. The importance of thinking with non-dimensional parameters while comparing the domains having different references was highlighted. Finally, in the Appendix part a research on seashells and terminology of Conchology were presented.

¹ Research conducted under the advice of Dr. Chris Williams, the author's mentor at University of Bath.

² Research and seminar given by Prof. Dr. Julian Vincent and others on Biomimesis at the "Centre of Biomimetics", Bath, England, where a seminar was given by the author on August 01, 2005.

³ Tests carried out in collaboration with Dr. Caner Durucan at METU, METU.

1.4 Disposition

Chapter 2 comprises a literature survey regarding the relationship between nature and architecture, and an explanation of Biomimesis in architecture. The real meaning of Biomimesis as a new discipline and its representative examples are also explained in this part. This chapter also aims to examine how ideas and inspirations drawn from nature have affected architectural design throughout history, and whether the outcomes can be considered as the real meaning of “Biomimesis in architecture” or not.

Chapter 3 presents the theories and postulates of the study, why this study was proposed and conducted and the question of how Biomimesis can serve as an innovative design paradigm is emphasized. A classification is carried out regarding structures in nature and architecture and any similarities between them are highlighted, giving pioneering examples from the 20th century.

In Chapter 4 the materials used to conduct this study and the methodology of the doctoral research are described.

In the Chapter 5 interpretations of the seashell in architecture are demonstrated following the studies on seashell geometry, and seashell modeling approaches in different disciplines are presented. The deficiencies of these models are explained and a new model is proposed. In addition, data collected from the testing of shells is statistically analyzed. Results were evaluated and a series of non dimensional parameters are introduced. The meaning of “learning from nature in architecture” is discussed through those non dimensional parameters.

In the last chapter, conclusions derived from this research and recommendations and suggestions for future studies are presented.

Appendix A introduces general explanations on seashells and terminology of Conchology. Appendix B represents a timeline highlighting developments in biology and architecture.

CHAPTER 2

LITERATURE SURVEY

If one way be better than another, that you may be sure is Nature's' way (Aristotale, 4th century B.C.E) (Vogel,1998)

Human ingenuity may make various inventions, but it will never devise any inventions more beautiful, nor more simple nor more to the purpose than Nature does; because in her inventions nothing is wanting nothing is superfluous. (Leonardo da Vinci 15th century) (Vogel,1998)

Source of hydraulic contrivances and of mechanical movements are endless in nature; and if mechanists would but study in her school, she would lead them to the adaptation of the best principles, and the most suitable modifications of them in every possible contingency. (Thomas Ewbank, mid 19th century)(Vogel,1998)

One hand book that has not yet gone out of style, and predictably never will, is the hand book of nature. Here in the totality of biological and biochemical systems, the problems mankind faces have already been met and solved, and through analogues, met and solved optimally. (Victor Papanek, 21st century)(Papanek, 1971)

The human race, since its very beginnings, has had a tendency to discover and learn from its environment. In this primitive observation/learning/design process, mankind has adapted and developed skills to provide for his needs by imitating, interpreting, and using examples found in nature. Mankind's relationship with nature was a peer-to-peer experience, and learning from nature was the only source available to him until the industrial revolution. After that turning point, new horizons triggered new technologies, and tools for observation became more advanced. Although the relationship between man and nature is as old as the history of mankind, a new aspect of this relationship has been born out of a changed point of view, more advanced tools for observation, an enhanced relationship between man

and nature, and a new generation in learning, adaptation, and design. All these have combined to result in a new branch of science: Biomimesis.

2.1 The concept of Biomimesis

Biomimesis, which is derived from the Greek words, *bios* meaning life, and *mimesis* meaning to imitate, is defined as “*the study of the formation, structure, or function of biologically produced substances and materials (as enzymes or silk) and biological mechanisms and processes (as protein synthesis or photosynthesis) especially for the purpose of synthesizing similar products by artificial mechanisms mimicking the natural ones*”⁴. This definition emphasizes the two important features of Biomimesis, which are:

- The artificial synthesis of naturally occurring materials, substances, or other structural configurations.

- Mimicking biological processes in creating life-like products.

As can be seen, both of these features concern the synthesis of specific materials or structures, and only differ in how directly and in what manner the product comes into being.

In literature, the approach of using ideas from nature to further technology has been given a number of names in different disciplines, such as, Biomimetics, Biomimicry, Biognosis, and Bionics (Vincent, 1995, 10) according to the nature of the discipline. Generally, studies related with the study of natural processes and systems for innovations, solving problems, and developing new technologies is known as Biomimesis. In this study, the term “Biomimesis” is the preferred term for a new field of science that allows a study of nature’s best ideas and then imitating and implementing them to solve hurdles faced by mankind. “Biomimetic” is used as the adjective form of Biomimesis, like Biomimetic researchers or Biomimetic studies etc.

⁴ Merriam Webster Dictionary <http://www.m-w.com/cgi-bin/dictionary?va=biomimesis>

Biomimesis as an approach for innovation is not new; indigenous people relied on lessons learnt through their experiences with nature, its processes, and its examples. The invention of the airplane by the Wright brothers was a direct consequence of their observation of the wings of birds. It is possible to say that this concept has been implemented since the very first arrival of the human being on earth, throughout the history of invention and industrialization (French, 1988). The concept of Biomimesis was proposed as a science by Benyus in her book entitled "Biomimicry" at the end of the 20th century, and since 1998 the term has been used to describe studies that provide clues and answers to the needs of mankind through the observation and analysis of nature (Benyus, 1998).

Recently, scientists have begun to take more ideas from nature, especially since the explosion in biotechnological research, and some similarities exist with the periods prior to the industrial revolution. Biomimetics is currently being used to explore a variety of design projects, including the development of different biomaterials, most notably spider silk, robot design, animal models, and artificial intelligence.

Likewise, each discipline has its own "understanding" and "interpretation" of Biomimesis according to the realm, and subsequently sets up and follows its own methodologies to derive innovative ideas from nature. A classical example of this process has been the development of the so-called "lotus effect", used in developing dirt- and water-repellent paint coatings for self-cleaning building facade finishing, which is based upon observations of the surface of the lotus flower plant and how it always seems to be "clean", even in muddy and swamp areas. Similarly, learning to grow food as in a prairie, weaving fibers like a spider, computing like a cell, finding cures like a chimp, running a business like a redwood forest etc. are some other examples of how Biomimesis is involved in the progress of mankind. In engineering applications, aerodynamic forms of planes and ships resulting from the observation of fish and birds; hulls of boats imitating the thick skin of dolphins; sonar, radar, and medical ultrasound imaging imitating the echolocation of bats; artificial organs and prosthesis imitating the human body itself are only a few examples of the impact of Biomimesis in different branches of engineering.

Some researchers are looking at natural processes of construction in the hope of finding efficient, less polluting ways to build structures. At Sandia National Laboratory in Albuquerque, researchers are attempting to mimic the structure of abalone shells, which are among the hardest and most durable elements in nature. These shells are made up of alternating layers of hard and soft material. When a crack occurs in a hard layer, it is absorbed by the soft layer and does not spread (Robbins, 2001).

In the field of computer science, the study of bionics has produced cybernetics, artificial neurons, artificial neural networks, and swarm intelligence. Evolutionary computation has also been motivated through Biomimetic ideas, but has taken the idea further by simulating evolution in silicon and producing well-optimized solutions that have never appeared in nature. In particular, studies into artificial intelligence in different fields, such as the analysis of medical signals, robot prosthesis; complex systems, chaos and fractal theories, Hopfield nets, neural networks, genetic algorithms, Expert Systems and Fuzzy Logic in Applied Sciences; Turing machine and tests, Chinese room experiments in Philosophy, and so on, are all revolutionary Biomimetic studies in different disciplines (Gönenç Sörgüç, 2006).

2.1.1 Why and How Biomimesis Works

“Biological knowledge is doubling every five years, growing like a pointillist painting toward a recognizable whole. For the first time in history, we have the instruments-the scopes and satellites-to feel the shiver of a neuron in thought or watch in color as a star is born. When we combine this intensified gaze with the sheer amount of scientific knowledge coming into focus, we suddenly have the capacity to mimic nature like never before”⁵.

The expansion of optical horizons through the use of electron microscopes, photography, photogrammetry and stereoscopy has allowed scientists not only to observe biological forms, but also explore several different biological processes, beginning in the early decades of the 20th century. With the help of these observations it has been widely understood that in production processes, different

⁵<http://www.biomimicry.net>

from man-made applications, nature generally manufactures at low temperatures, without toxins, and using few raw materials. Similarly, when living things in nature are studied it is seen that most of the examples have both lightweight and strong structures, precisely what architects are looking for in architecture. Furthermore, as Benyus points out, nature banks on the diversity of polycultures rather than the vulnerability of monocultures, and nature computes using shapes, not symbols. These and other new ideas inspire scientists and researchers, and help them to brainstorm ways to change the way we think and improve upon them for further developments (Benyus, 1998).

According to Biomimetic researchers there are basically three fundamental ways to learn from nature in order to solve a specific problem, namely, by considering nature *“as a model, as a mentor, and as a measure”*.

Firstly, nature can be a *“model”* and Biomimicry studies nature’s models and imitates or takes inspiration from these “designs” and “processes” to solve man’s problems, as in the case of designing a solar cell, taking inspiration from a leaf. The “intelligence” encoded in nature provides “field-tested” methods of form and function from which organisms have solved their problems of adhesion, nutrition, resilience, communication through air, resistance to bio-fouling, etc. Moreover, to be able to learn how nature makes things, using simple chemicals at moderate temperatures without the production of toxic by-products would be a further model for researchers. Secondly, nature can be a *“measure”*, and Biomimicry may use an ecological standard to judge the “rightness” of man-made innovations. Questions such as: Are they life affirming? Do they fit in? Will they last? What works? What is appropriate? could be answered, which are highly relevant in contemporary environmental concerns. Finally, nature can be a *“mentor”*, and Biomimicry can be seen as a new way of viewing and valuing nature. It may introduce an era based on not only what can be extracted from the natural world, but what can be learnt from it (Benyus, 1998).

Nowadays, Biomimetic researchers are discussing and seeking possibilities to create innovative designs inspired from nature in many fields: from medicine to agriculture, and from informatics to engineering in interdisciplinary platforms. Many

researchers, thinking similarly with Benyus, and sharing similar concerns have declared that, *“human beings are about to experience a ‘Biomimetic Revolution’ in which critical needs in medicine and industry will be addressed by creating new materials and devices that incorporate innovations inspired by nature. Within this framework unlike the Industrial Revolution, the Biomimicry Revolution introduces an era* (Benyus, 1998).

Scientists, researchers, and designers from several different disciplines are seeking new designs, production processes, and even ways of conducting business following lessons learnt from “Biomimesis”. By studying the achievements of researchers from various disciplines, it would seem that Biomimesis has the potential to make products cheaper, better, more efficient, and more ecologically friendly.

BIOMIMETIC STUDIES

from biological perception to technological conceptualisation

<p>innovations leonardo da vinci 16th century</p> <p>imitating the thick skin of dolphins</p> <p>inspired by a shrubby tree in texas, michael kelly 1868</p> <p>flight of buzzards wings wright brothers 1904</p> <p>annoying cockleburrs george mestrall 1940</p> <p>38 interconnected "diving" chambers of nautilus</p> <p>neuron cell and transferring information in a brain</p> <p>taking inspiration from a leaf</p> <p>robotics imitating the human body</p> <p>imitating the echolocation of bats</p> <p>lightweightness observation of fish and birds</p> <p>ventilation design of termite mounds</p> <p>reducing air resistance noise- owl plumage</p> <p>the mechanism gecko lizard to walk on surfaces</p> <p>self-cleaning preperities of flowers lotus effect</p> <p>refraction of bird feather, ray anderson 1995</p> <p>publish "Biomimicry" janie benyus 1998</p> <p>chromatophores cells of chameleons reflecting color</p> <p>logarithmic spiral occurs in many places in nature</p> <p>artificially mimicking the process of photosynthesis</p> <p>proprietary bacteria oxidises primary sulphide minerals</p> <p>filter-feeding whales to keep their baleen clean</p> <p>biomaterials emulate shark skin texture</p> <p>biomimetic robots the sprawl-legged cockroach</p> <p>fuzzy logic insulation layers of penguins</p> <p>chemical structure of spider silk</p> <p>imitating a natural ecosystem john todd</p> <p>snail movement exploration internal human anatomy</p> <p>how abalone build their shells dr.belcher 2004</p> <p>collagen protein fibers of crocodile skin</p> <p>luciferin of fireflies produce greeny-yellow light</p> <p>damage reducing structure of pearl/nacre</p> <p>the way trees divide themselves into branches</p> <p>how bats avoid obstacles in front of them</p>	<p>huts</p> <p>tents</p> <p>inovations</p> <p>hulls of boats</p> <p>barbed wire</p> <p>airplane</p> <p>velcro® fastener</p> <p>compartments of submarine</p> <p>modern microprocessor</p> <p>solar cell</p> <p>artificial organs -prosthesis</p> <p>sonar, radar, ultrasound</p> <p>aerodynamic forms of planes</p> <p>eastgate complex, zimbabwe</p> <p>japan shinkansen 500-series</p> <p>new type of adhesive</p> <p>lotusan® building facade</p> <p>entropy® carpets</p> <p>biomimetic revolution</p> <p>clothes that change color</p> <p>pax® impeller</p> <p>dsc® dye solar cell</p> <p>bioheap® heavy industry</p> <p>baleen® filter technology</p> <p>speedo's fastskin® suits</p> <p>nasa-robots exploring mars</p> <p>smart fabrics</p> <p>kevlar®</p> <p>living machine® sewage treat</p> <p>snail robots</p> <p>rechargeable batteries</p> <p>fiberglass technology</p> <p>efficient light-generating</p> <p>screw of jet engines</p> <p>zic® fiat (zero impact car)</p> <p>RoBat® smart acoustic sens</p>
	<p>prior periods</p> <p>1990's</p> <p>innovation inspired by nature</p> <p>2000's</p> <p>...</p>

2.2 Nature-Architecture Relationship

In this section it is aimed to examine how the ideas and inspirations from nature have affected architectural design throughout history, and whether the outcomes can be considered Biomimesis in architecture or not.

In its long fight for survival in nature, mankind has observed nature and has come up with solutions to its own problems by imitating, interpreting, and synthesizing its processes since the very beginning. Thus it is unavoidable that similarities between nature and man-made designs/products will be encountered (Arslan Selcuk et al, 2004).

Architects seeking to provide means for man to live in harmony with nature have also been affected by nature at different levels, either by the forms, by the structural systems, or simply by considering nature as a means for ornamentation, disregarding the periods, styles, and trends of which era to which they belong. Hence, in this part of the study the “influence of nature on architectural design” is discussed by studying benchmark projects throughout the history of architecture within the realm of Biomimesis, as explained in the previous section, as a general concept.

2.2.1 Observation of Prior Periods

“The architects of the future will build inspired by nature because it is the most rational, the most durable and the most economic of all methods” Juan Torras, 1810 (Senosiain, 2003)

The beginning of studies of natural phenomena in architecture can be seen to date back to the time when human beings first learned to build their own shelters. Vitruvius declared that the “development of architecture” was based on the discovery of fire and language (Vitruvius, 1998). In these early societies some began to make roofs with branches, other dug caves out of mountains, and others, imitating the nests built by swallows, built shelters out of mud and sticks. Observing the huts of others, using those improvements or creatively making their own, they

began to build better and better dwellings. Human beings do not only use natural materials, but also pick up practical examples to stimulate new ideas (Portoghesi, 2000). By observing the world and sharing their experiences, humans can continually improve their inventions and use them to create “history”.

Some examples of how man used and interpreted examples from nature in design and construction in different cultures and different environmental conditions are given in Figure 2.1. Influences from nature can be seen across the board, from simple nest-like huts to sophisticated bulbous domes. Similarly, human beings used to decorate buildings with flowers, leaves, and figures of animals because of some aesthetical considerations or because of some religious beliefs (Arslan Selçuk et al, 2005b). On the other hand, mankind made use of the “constructions in nature” after acquiring an intuitive knowledge of construction through the observing of his environment. When Gothic architecture is examined a very deep and developed intuitive knowledge of construction becomes visible. The branched support, the tree structure, can be first observed in the ribs of the Gothic style. Structures stiffened by ribs are reminiscent of plant structures, branches, and especially leaves, supported by linear rib-like tissues. Gothic structures can be considered as lightweight structures of masonry architecture. There is an accumulation of material onto which the load is concentrated, while the other parts are lightened.



Figure 2.1 Images from different regions inspired by natural forms (Source: Portoghesi, 2000).

When individual examples are considered, Horatio Greenough, who was an American sculptor, named the analogy between nature and architecture as “eclecticism”. In the mid-18th century he rejected the aesthetic conceptions by considering nature as a source, with its diverse forms reliance on pre-existing models (Lampugnani, 1989). It is interesting to note that the Crystal Palace in London, considered as “the turning point which introduced a new direction to the entire architectural design process”, was also inspired by nature. Over 150 years ago, Joseph Paxton, a gardener, drew inspiration from the Victoria lily leaf for his design of the roof of the Crystal Palace (Margolius, 2002). He found that each leaf was supported by radial ribs, stiffened by slender cross ribs that helped to maintain rigidity and strength across the leaf. Even though the Crystal Palace was made entirely from glass and cast iron, Paxton’s knowledge of the lily pad made it possible to create a light yet strong roof, big enough to cover 18,000 square meters. As Hertl (1966) highlighted, the roof structure of this gigantic steel and glass exhibition hall bears also an amazing similarity to the lattice-work and articulation of the dragonfly’s wing. Similarly, the designer, in his own words, emphasized that “*I conceived this extremely fine-membered structure in my youth, as a gardener, by studying the leaf skeleton of the tropical water lily, Victoria regia*”. No matter what the real source of the designer’s inspiration was, it is obvious that nature affected the design of this important building.

Nature’s effect on architecture has followed many trends and spreads over many different periods of architecture. The examples chosen from the early-20th century show the breadth and variety of the points of view expressed by the architectural movement connected to the notion of Organicism. It can be concluded that in the past architects and engineers more often received inspiration from shapes found in the animal and plant world and learned the basic principles of the structural behavior of those shapes. Although architects have gained insight into the basic structural principles of the natural objects and structures they have experienced, they rarely go much further than copying nature’s motifs for ornamentation.

2.2.2 Architectural Trends Inspired from Nature in 20th Century

"In architecture there are two necessary ways of being true. It must be true according to the program and true according to the methods of construction. To be true according to the program is to fulfill exactly and simply the conditions imposed by need; to be true according to the methods of construction, is to employ the materials according to their qualities and properties..." Entretiens sur l'architecture, 1863-72 (Frampton, 1996).

The French architect Eugène Emmanuel Viollet-le-Duc (1814-1879) in his writing, did not address nature and its structures, however his words matched the "construction principles" of nature. In his theoretical writing he championed the Gothic style because he felt that its form was determined by structural necessity and was derived from construction and materials. Thus he proposed the use of 19th-century techniques and materials, especially cast iron, according to the same rationalist principles employed by the Gothic masons (Murphy, 2000).

Outside France his ideas had their most pronounced impact on the work of Antoni Gaudi, who holds a special place in the history of architecture. He not only developed an original style of his own but also brought together form and construction in a successful way. Gaudi's designs revealed the idea of an autonomous system in which the coherence between the form of the supporting structure and the final form of the building appears as the most important subject. The architect, who practically never travelled, drew his inspiration from his ability to observe and implement the countless details offered by nature. He differed from the other artists of Art Nouveau by including natural forms more realistically in his designs.

In Gaudi's Casa Batllo, *"a transitional effect between the sculptural plasticity of Gaudi's earlier years and the structural type characteristic of his later period can be observed. Natural and organic forms are no longer ornaments superimposed on the building, but constitute essential structural elements, as in the case of bone-shaped columns"* (Lampugnani, 1989). Following nature's structures with the use of curves (Figure 2.2), Gaudi took natural forces into consideration during the design process.



Figure 2.2 Examples from Antoni Gaudi (source: <http://www.organicarchitecture.com>)

He searched for efficient and innovative structures through his experimental studies, in which it can be seen that he examined the flow of forces in detail and used that understanding to shape his buildings (Masso, 1999). In this sense Gaudi's "design process" mimics the natural process of formation of structures under several internal and external dynamic, static, and environmental loads.

In the years following Gaudi's success, Expressionism arose as a phenomenon which principally began in Germany. It was Peter Behrens who achieved the transition to Expressionism in his buildings with the AEG in Berlin. Hans Poelzig, Max Berg, Otto Bartning, Hugo Haring, Erich Mendelsohn, and Rudolf Steiner were other architects clearly distinguishable as Expressionists, employing crystalline forms and organ-like forms recognizable in their buildings, besides their organicist ideas (Dordan, 2002).

Rudolf Steiner (1861-1925) claimed that the idea that a building should be "adapted to what takes place in it, like a nut, called Anthroposophy", relying on the principle of growth of plants and conveying Goethe's principle of plant metamorphosis. With folds all over, it has a crystal-like appearance at first sight, but the edges are not as sharp as they are in crystals and there is no regular geometry. It displays a solid character instead of a ribbed, skeletal one. Steiner claimed that in order to discover the "true" organic form, rather than to impose an extraneous form, man should act in accordance with nature, not imitate it. He refused the grid of geometric formation, and instead emphasized an image related to "organic order" (Sharp, 1972).

During the First World War, the proposed Alpine Architecture designs of Bruno Taut (1880-1938) were evidence of a change in architecture. In these designs Taut proposed crystal-like structures for the peaks of the Alps. In 1919, together with like-minded artists and architects, Taut organized the Glass Chain. Hermann Finsterlin, brothers Hans and Wassili Luckhardt, Walter Gropius, Hans Scharoun and Max Taut banded themselves into a forum to exchange architectural ideas, drawings, and fantasies. Their common aim was to overcome hardened academic architecture with fundamentally new constructional forms taken from animate and inanimate nature (Gössel & Leuthäuser, 1991). Crystals, shells, amoebae, and plant forms were favored as models for future architecture; and for structural purposes, glass, steel and concrete were the preferred materials, reflecting the influence of Bruno Taut (Lampugnani, 1989). Crystals and crystal formations are the examples of structures of a non-living nature and are solid load-bearing structures. However, the glass pavilion of Taut has a lattice structure that is still made up of linear elements.

Frank Lloyd Wright, Hugo Haring, Hans Scharoun, and Alvar Aalto are some of the remarkable personalities of this movement of architecture. Among them, Frank Lloyd Wright (1867-1959) was accepted as one of the most innovative and influential figures in Modern Architecture. In his radically original designs, as well as in his writings, he championed the virtues of what he called organic architecture, a building style focused on harmony with nature. For Wright, the word “organic” was tied to the use of the concrete cantilever as though it were natural tree-like form. In the Johnson Wax Administration Building this organic metaphor revealed itself in tall slender mushroom columns becoming thinner towards their bases (Heinz, 2000).

Already in the 1920s, with the reinforced-concrete shell structures of Franz Dischinger and Walter Bauersfeld, the comparison to an eggshell was evoked. Although being compatible only with single-arched structures, the necessary technology was developed by Dischinger, Finsterwalder and Bauersfeld in the 1930s. Load carrying capacities were improved by more complex forms, such as double-arched saddles. (Gössel & Leuthäuser, 1991). It was shown that by means of a double curvature in form and the use of materials having the capacity to withstand higher tensile and compressive stresses, great spans, combined with exceptionally thin constructions, were achievable.

Among the engineers who began to apply technically appropriate and elegant solutions to reinforced concrete constructions, Robert Maillart, Edouardo Torroja, Eugéne Freyssinet, Pier Luigi Nervi, and Felix Candela were notable pioneers. It is possible to say that especially Nervi and Candela had a deep interest in natural structures. Nervi (1891-1979) had an ability to derive beauty from the natural forms and from the selection of the right materials and techniques. In his opinion *“the process of creating form is identical, whether it is the work of technicians or of artists: the principle that is, whereby the beauty of a structure, for example, is not just the outcome of calculations, but of an intuition as to what calculations to use, or with which it is to be identified”* (Lampugnani, 1989).

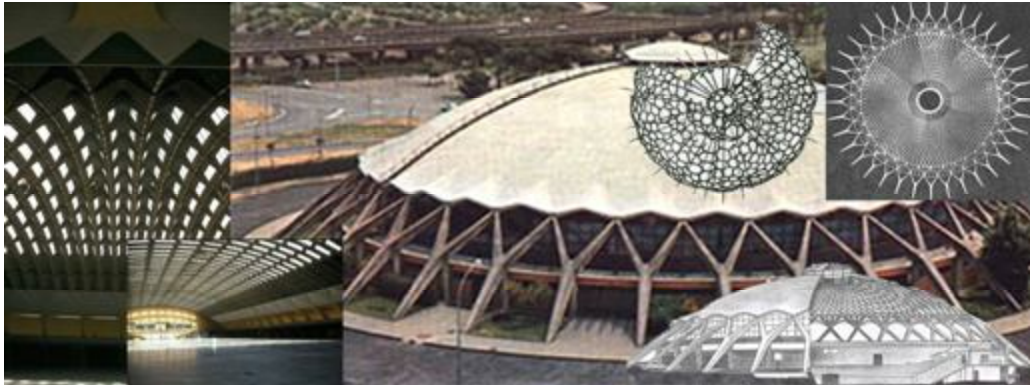

Figure 2.3 Exhibition building in Turin and Small Stadium in Rome (plan of the dome and 200 times magnified Radiolarian) (Source: Mainstone, 1998)

His Exhibition Building in Turin shows that he achieved in obtaining “strength through form” in buildings, which was the aim of his studies and experiments. The enormous building consists in effect of a single roof structure, made up of undulating prefabricated units (Figure 2.3).

It is arguable that light vaults and domes were the most important architectural innovations of the 1950s, most of which were contributions of engineers like Spanish architect Felix Candela, who drew on his experience as a builder to construct the thinnest conceivable shell with the design of a roof in hyperbolic paraboloids only 15 mm thick (Cosmic Ray Building 1951, Mexico City). His method of shell construction

is notable for its extreme economy of material. He designed a variety of structures that used hyperbolic paraboloids, or saddle-shaped shells, which were stiffer and easier to build than other shell constructions. Like Nervi, Candela claimed to have been guided less by exact calculations than by an intuitive feeling “in the manner of the old master-builders of cathedrals”. This intuition was based on his knowledge of materials and stresses, accumulated from each of his projects.

In 1961 Frei Otto met biologist and anthropologist J. G. Helmcke, and together they founded the research group Biology and Nature to examine the many and varied biomorphous constructions of algae, which became an important inspiration in Otto’s designs (Gössel & Leuthaser, 1991). With similar ideas, Otto experimented on many natural objects at the Institute for Lightweight Structures, founded in 1964 at the University of Stuttgart, and developed new constructions through analogy with natural models. He concentrated his attention on the analysis of biological phenomena, developing his exploration and analysis of lightweight structures in nature. His research was focused on the optimized features of structural forms in nature and lightweight construction (Drew, 1976). His experiments with suspended chains were to find shapes for a long-span suspended roof, stabilized by its own weight without pre-tension. Soap film experiments to produce minimal surfaces were performed with an understanding of natural phenomena, with the understanding that a soap film always contracts to the smallest surface possible. The concept of soap film minimal surfaces was then applied to the tent structures (Otto, 1995). Many features of his cable-net roof experiments are inspired from spider’s webs. He concentrated on how to achieve more with less, that is, less material and less effort. He developed innovative structures of extreme lightness coupled with extreme strength, making optimum use of new materials such as thin cables of high-strength steel or thin membranes of synthetic fabric (Figure 2.4).

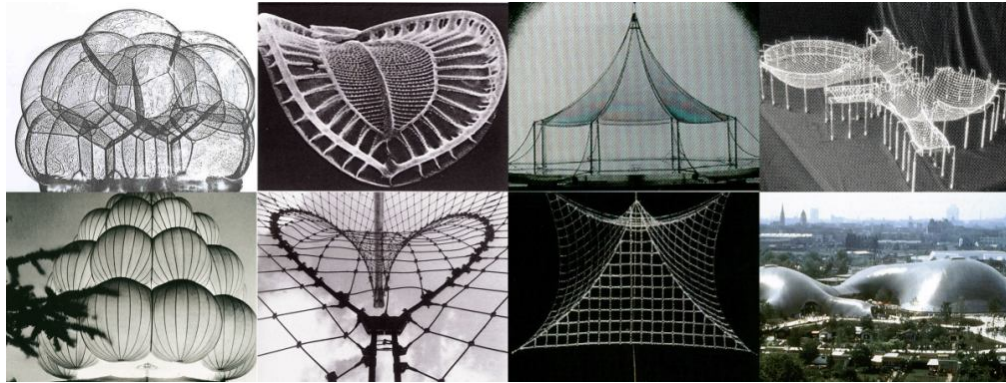

Figure 2.4 Studies from Frei Otto (Source: Otto, 1995)

The works of D'Arcy Thomson and Frei Otto were used as references for nature's strategies in achieving strength in rigid tissue forms. Robert Le Ricolais' documentation of his experimental research workshop at the University of Pennsylvania clarified how analogical thinking advanced structural ingenuity in the design process. Fred Angerer's investigation into surface structures demonstrated that conceptual analogy could be linked with technical strategy in the structural articulation of load bearing surface forms. He explained how to explore the concept of minimum material for maximum strength and the relationship of geometric patterns to highly effective forms that resist compression and bending forces like in natural ones (Otto, 1995).

In his 1969 book "Architecture 2000-Predictions and Methods", Charles Jencks predicted that the influence of major biological inventions in 1980s and 1990s would result in the most significant architectural movement of this century - the Biomorph School (Jencks, 1971). He wrote that the Biomorph School had already had a long history reaching its zenith at the beginning of the 20th century with the work of Antoni Gaudi and Frank Lloyd Wright, and later gaining in strength with the work of Soleri Goff, Kiesler, Scharoun, the Metabolists, Johansen, Rodilla, O'Gorman, Cou elle, Hausermann, Bloc, Katavolos, Guedes, Doemach, and at times Le Corbusier. According to Jencks, the Biomorph School was already a strong movement (Figure 2.5).

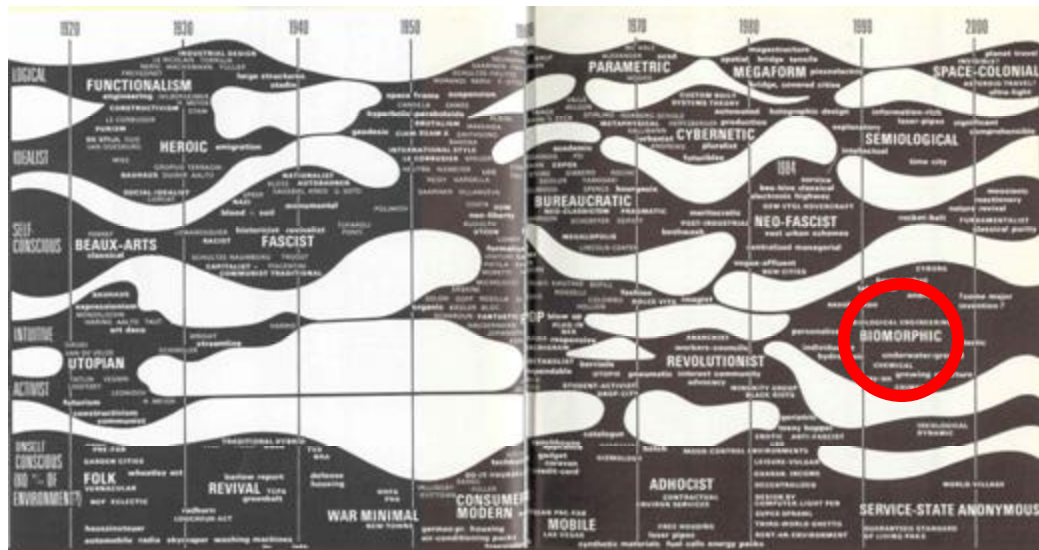

Figure 2.5 Table of architectural concepts by Jencks (Source: Jencks, 1971)

Taking individual examples from recent years, Renzo Piano’s design, the Jean-Marie Tjibaou Cultural Center, exhibits a harmony with nature by using local materials and combining traditional techniques with technology. This building has external forms that resemble vegetables growing from the ground. They are framed by curving laminated pine ribs, which are secured together using stainless-steel rods, and have bamboo and bark slats on the outside. The structures provide shade for the spaces below and guide wind and convection. They have a lattice-like appearance which brings to mind plant tissue. Likewise, the Japanese capacity for combining high technology with nature and tradition can be seen perhaps at its most extreme in the Kansai International Airport and Passenger Terminal Building in Osaka, Japan. “In this prize-winning project, in December 1988 in an international competition, Renzo Piano with his partner Noriaki Okabe seems to have found the perfect mean for his noted ability to apply the laws and forms of nature to sophisticated high-tech systems.” (Buchanan, 2005)

A widely-used structure of nature is the “tree”, which can be found in numerous examples from earliest periods of architecture. Norman Foster’s terminal building at Stansted Airport is a steel-structured building with a roof composed out of a series of shallow, partly-glazed domes supported by a forest of tree-like structures (Foster

and Partners, 2005). The columns are generated by the functional requirements of the terminal and the need to provide maximum flexibility at the passenger floor level. The tree-like structures are comprised of clusters of four interconnected tubular steel columns. Similarly, Stuttgart Airport, designed by von Gerkan and Marg, completed within weeks of Stansted Airport, has a huge sloping-roof supported by 12 very tree-like steel structures, in which the loads can be seen to be descending through an elaborate hierarchy, from twigs to branches to trunks, all fundamentally in compression (von Gerkan, and Marg, 2007).

The examples included in this part of the study reveal the influence of nature in 20th century architectural designs explicitly, and are accepted as benchmark examples of their era. Yet it is possible to multiply the number of examples yielding the influence of nature, either in the design or process, or in the final artifact.

It is unavoidable that when nature is imitated there will be differences of scale, function, and internal structure, especially when the natural form is a living organism. The most significant difference between them is the differences between the processes of construction and natural growth (Mainstone, 2001). These differences have had a marked effect on the development of architectural forms.

Even though the scale, function, and process may be different in nature, design constraints and objectives are very similar: functionality, optimization, and cost effectiveness are targeted to co-exist in man-made products. Therefore, it is no surprise that mankind has always admired biological structures and has often been inspired, not only by their aesthetic attributes, but also by their design and structural quality and efficiency

2.2.3 Inspirations from Nature in Contemporary Architecture

Biomimesis is a term used to describe the act of developing different methodologies inspired by nature to innovate and provide solutions in various disciplines. Until now, Biomimesis in architecture has been restricted in terms of understanding and usage, limited to being either “a form finding process” inspired by countless forms, colors

and details from nature, or as a way to provide solutions for sustainable/green designs. As is evident in Koelman's (2003) comments on the matter, Biomimicry can be applied to buildings in three fundamental ways; "*by making stronger, tougher, self-assembling, and with self-healing materials; by using natural processes and forces to accomplish some comfort requirements of buildings such as heating and cooling; and finally by providing resources, rather than draining them, by using/applying the principles of Biomimesis for zero waste and co-evolution*". Those approaches are actually coupled well with the declaration of Benyus.

In this regard, as an example the natural ventilation system of the Eastgate building by Arup in Harare, Zimbabwe drew inspiration from African termite towers (Figure 2.6). Termites build their homes in the desert in extreme temperatures, and yet manage to keep the interior of the building cool and clean. The mounds are cooled in a very clever way that uses the stable low temperatures under the ground. According to Koelman (2002), from a whole-system perspective, the African termite mound might be the supreme example of advanced animal architecture, incorporating exquisite solutions to design problems (structural strength, elemental protection, ventilation, humidity control, etc.) that architects also face. So far, at least one building has been highly successful in mimicking this sophisticated ventilation system. From this perspective the Eastgate building uses the termites' nests as a source for innovation in the building's HVAC design to keep the building cool, even on the hottest days. Using nature-inspired designs for the ventilation and heating/cooling of buildings instead of high energy-consuming HVAC systems, as in this example, indicate potential for further innovative design solutions for more environmentally friendly, and yet efficient, building systems.

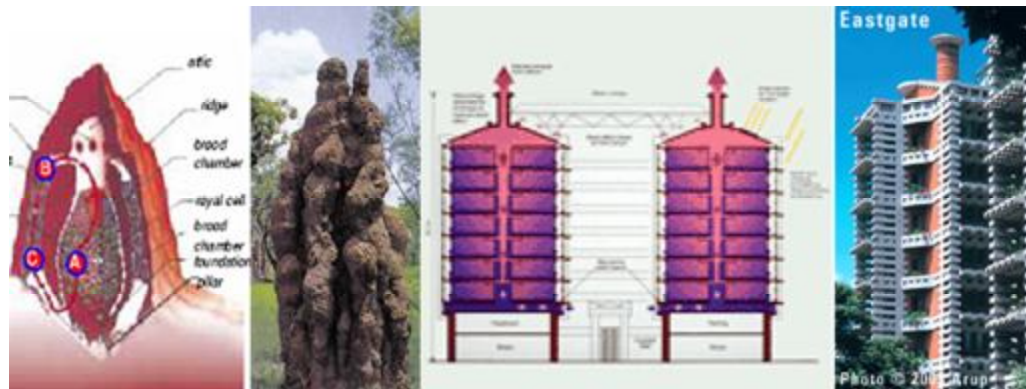

Figure 2.6 Section and view from the African termite towers and the Eastgate building by Arup in Harare, Zimbabwe. (Source: <http://www.arup.com/expertise/casestudy.cfm?studid=6>)

Another example inspired from this system is the Ionica Building, Cambridge, designed by the RH Partnership. The designers of this building admit that they took lessons from the humble termite regarding their heating and ventilation properties. Natural resources are used to regulate the temperature within the building, and as a result running costs have been reduced by 45%⁶.

There are several other architectural designs which are acknowledged as Biomimetic buildings due to their sustainable solutions, whether related to their design or to the building systems that they contain. For instance, in all of its five areas, as specified in the in the project, the Eden Project, Cornwall, UK designed by Grimshaw is accepted as Biomimetic. Its aim is to promote the understanding and responsible management of the vital relationship between plants, people, and resources, leading towards a sustainable future for all (Grimshaw, 1993) (Figure 2.7). In the same way, the Kalundborg Industrial Symbiosis project in Denmark is another Biomimetic approach. Symbiosis means a co-existence between diverse organisms in which each may benefit from the other. In this context, the term is applied to the industrial cooperation taking place in Kalundborg between a number of companies and the Kalundborg Municipality, all of which exploit each other's residual or by-products. All the above projects are considered to be environmentally and financially sustainable. Finally, having a double skinned façade, Plantation

⁶<http://www.battlemccarthy.demon.co.uk/projects/ionica.html>

Place, London, by Arup has a blind system which responds locally to the sun, keeping it in or out only where and when absolutely necessary. It also has an air filtration system which works rather like the human lungs. Polluted air is kept out at ground level, while cleaner air is drawn in from higher up and pumped through the building.



Figure 2.7 View from Eden Project (Source: <http://www.eden-project.co.uk>)

Biomimesis can also be applied to buildings in terms of new sustainable materials. The need for cleaner buildings by maintaining surface coatings for as long as possible without polluting the environment with chemicals in paints and dust and dirt provoked Prof. Dr. Wilhelm Barthlott from the University in Bonn, Germany, to ask "How does nature clean surfaces?" He focused on this question and examined the surface of the leaf for clues. His research team found that nature has a way of structuring surfaces with self-cleaning properties, especially the "lotus" plant, which lives in muddy environments and has a self-cleaning leaf (Koch, 2004:7). This insight has given rise to a new type of building façade with a texture that has properties comparable to the lotus leaf: water droplets from the rain roll off the surface, automatically removing dirt as they wash over. A German company is manufacturing such a product, called Lotusan⁷ as an architectural material. To sum

⁷ http://www.lotus-effekt.de/en/lotus_effect_html.html

up, in the 1970s Professor Barthlott's discovery on the self-cleaning properties of lotus leaf, followed by studies into its nanostructure and the application of its design onto glass, plastic and other materials to ensure long-term resistance to staining from environmental effects, such as pollutants in air, is a very remarkable example of Biomimetic design. (Figure 2.8)

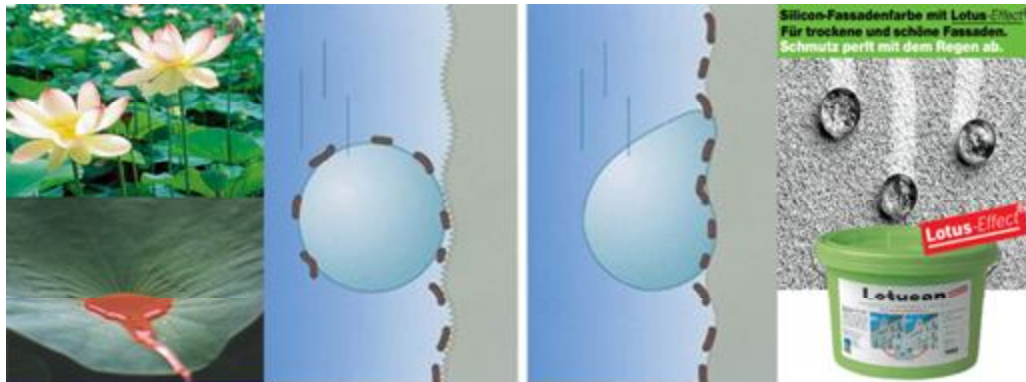

Figure 2.8 Lotus effect (Source: www.lotusan.de)

Lastly, an important field of application is the design of kinematic structures, which is a subject of interest of the new century, for which there are clues and answers in nature as well (Arslan Selçuk et.al, 2005a). Zuk, one of the leading figures of kinematic design in architecture, asserts that life itself has an inherited motion, as in a single cell to the most complex organisms, from subatomic particles to galaxies. He goes on to state "...when motion ceases, life ceases" (Zuk, 1970). All living creatures in nature have the ability to move in order to live. For instance, animals move to migrate and hunt, or plants move according to climatic conditions, and all have particular mechanisms of their own for motion. Such propositions can be extended when the concept of Biomimesis is well-defined in an architectural context and thus allow design solutions having roots in nature with new potentials.

In concluding, as it can be seen from the following diagram (Table 2.2) that nature has always been a stimulating source on architecture and left clear traces throughout the history. Nowadays as it is seen from the same mapping, when the concept of "Biomimesis in architecture" is considered, the term is generally

interchangeable with the term “sustainability in architecture”. It is also possible to claim that increased Biomimetic studies and enhancing Biomimetic way of thinking would result in a drastic change in architecture. This respectful imitation is a radically new approach, a revolution. For the near future, unlike the Industrial Revolution, the Biomimetic Revolution will introduce an era based not on what we can extract from nature, but on what we can learn from it as a mentor.

Biomimesis can serve architecture with its all potential in a more extended way. Biomimesis can propose new and innovative solutions for forms, structural systems, and even systems for environmentally friendly kinematic/static/deployable structures, as can be observed in structures/forms in nature with the help of a systematic and methodologies to be developed specific for architectural design.

Current examples in architecture, related with Biomimetic developments, are still quite individual and sporadic due to the lack of systematic designing criteria for architecture and that disables being a discipline as in other research and implementation areas like engineering, medicine and agriculture. Architects, who want to be aware of “next technological wave” arising from advances in technology and science in consequence of observation of nature and its phenomena, and who want to design such buildings in accordance with those advances and reflect the features of the era to which they belong to, have the possibility to study the “nature-architecture” relationship using methodologies provided by the new discipline of Biomimesis.

Table 2.2 Changing paradigm in nature architecture relationship

changing paradigm of nature architecture relationship: biomimesis in architecture

prior periods
 decorating buildings with flowers, leaves figures of animals
 observing nature to acquire an intuitive knowledge
 classical 850 bc-476
 romanesque 500-1200
 gothic 1100-1450
 renaissance 1400-1600
 baroque 1600-1830
 rococo 1650-1790
 georgian 1720-1800
 gothic revival 1730-1925
 victorian 1840-1900
 arts and crafts movement 1860-1900
 art nouveau 1890-1914
 beaux arts 1895-1925
 expressionism 1910-1924
 art deco 1925-1937
 20th century trends 1900-2000

nature as a model

modern movement
 frank lloyd wright johnson was building mushroom columns
 hugo haring, hans scharoun, alvaro siza use of the concrete
 cantilever as though it were natural tree-like form.
organic architecture
 harmony between human habitation and the natural
 world unfold, like an organism, from the seed within
structural engineering
 franz dischinger walter bauersfeld robert maillart
 edouardo torroja, eugène freyssinet, pier luigi nervi
 felix candela engineers concrete shell structures
 comparison to natural shells
contemporary architecture
 frei otto and biologist-anthropologist g. helmcke
 experimenting natural objects institute for lightweight structures 1964 stuttgart
 developed new constructions analogy with natural models

nature as a measure

d'arcy thomson and frei otto used nature for the
 concept of minimum material for maximum efficiency

more examples of form finding process can be seen in table 3.1
 today

biomimesis in architecture

rh partnership ionica building, cambridge, taken lessons from
 the termite regarding their heating and ventilation properties
 eden project, grimshaw
 kalundborg industrial symbiosis project symbiosis means a co-existence
 between diverse organisms in which each may benefit from the other
 plantation place, arup air filtration system works like human lung
 lotusan ® biological innovation self-cleaning leaf maintaining building surfaces

biomimetic revolution in architecture

near future

via emerging biomimetic technologies and materials
 stronger, tougher, self-assembling, self healing materials;
 using natural processes for HVAC providing resources, rather than draining them
 provide a **systematic** and then **a system design** to analyze
 complex structures in architecture, to "learn" from them, and
 to propose new fields of implementations in architecture

nature as a mentor

CHAPTER 3

THEORIES AND POSTULATE

Today, while “what Biomimesis is and is not” is continuously brought to question; man is still learning to conceive nature as a source for further knowledge. Some disciplines, like robotics, biomechanics, chemistry, electronics etc., have been developing a systematic and methodologies for studying nature and its phenomena to find innovative solutions.

It is shown in the previous chapter that drawing inspiration and learning from nature, i.e. Biomimesis, has always been part of architectural design theory, revealing itself in the forms, structures, patterns, and colors in the search of lightness and material qualities which are found in nature. Yet, when examples in architecture are studied within the realm of Biomimesis, it can be seen that most of these “end-products” of such a process have, in general, failed to go beyond form finding processes, and many other potentials that can be brought into design using a Biomimetic approach have been ignored.

Recently, it has been observed that all living things in nature have the ability to fit form to function efficiently through structure and material, i.e. form, function, and materials come into existence simultaneously. This process can be considered as “multi-dimensionality in the natural world”. In this process every organism in nature avoids excesses and “overbuilding”, gains maximum efficiency with minimum material and energy, recycles and finds a use for everything, requires local expertise, runs on the sun and other natural sources of energy, and uses only the energy and resources that it needs (Benyus, 1997). These aspects that make the natural world sustainable are quite different from what human beings have experienced in their structures up until now. In man made products, contrary to the multi-dimensional properties of the natural world, the conventional manufacturing processes in man-made structures are very “linear”. In other words, man made structures come into being following the rigid order of a design process, starting from the design of form, followed by function, structure, material, manufacture, mapping of materials, and finally the end product.

In this study it is aimed to criticize the limited use of Biomimesis in architecture by considering developments in science and technology, the conveying of several other disciplines and so on. Although most of the studies in disciplines other than architecture have developed specific methodologies to embed Biomimetic elements into their research areas in an objective way, architecture is still in its infancy, experiencing only “form-creation processes”, mostly conceived as the inclusion of the use of computers and solid modeling interfaces as design tools. However, examples from different disciplines have proved that the use of biomimesis has more potential, and can contribute to re-experiencing and taking influence from the forms-structures-materials etc. observed in nature, providing not only flexibility in the creation of forms but also in functions and efficiencies in fulfilling their tasks. Hence, Biomimesis can be a new interface for learning, having its own systematic with objective design parameters to propose new design paradigms for architecture.

For this purpose, in this study of the realm of Biomimesis, the most common abstracted structures used in architecture are explored. Forms are to be classified in an analogous way to the structures found in nature. Classified forms and structures are studied not only for their formal resemblance, but also their form possibilities and structural properties, providing required static and dynamic stabilities and strengths accompanied by light-weight and minimized energy consumption.

3.1 Biomimesis in Architecture

The examples presented in the previous chapter, which are related either with the imitation of nature through forms for new challenging architectural designs, or through their functions for sustainable solutions, may not be adequate to give clues of how Biomimesis can be involved in the architectural design process, as has been experienced in other disciplines. In other disciplines, like mechanical and material engineering, robotics and medicine, Biomimesis has been successfully implemented with its own systematic and rules. Hence, in this dissertation, a “system design” in architecture is proposed, aiming to show all the possibilities of biomimesis in architecture while continuing to learn from nature.

The complex generation process of the form-structure-function trilogy to fulfill the “task of being existent”, as it is observed in nature, should be studied more in order to allow implementation with all its potentials in architectural design. Biomimesis can then be considered as a new “tool” in this exploration process through its systematic ways of analysis and synthesis, allowing development of methodologies peculiar to the field of interest. Hence it is possible to claim that Biomimesis in architecture is a new platform/interface in which architects not only imitate or are inspired by nature, but learn from it to provide efficient designs that include the best features of their studies.

After all the discussions above, it can be concluded that to understand the potentials of “Biomimesis in architecture” there is an apparent need to develop a methodology for architects. Architects should question natural processes regarding the multi-dimensionality of the process of their creation and evolution accordingly, starting from the abstractions of structures found in nature. Therefore, in the following section, firstly structures found in nature are classified, animate and inanimate structures in nature are discussed, and potential structural solutions are revealed from an architectural point of view. Then, the most common architectural structures that have been inspired from natural forms and structures are classified to understand to what extent they have affected contemporary architecture.

3.1.2 Biomimesis in Architecture: Relationship among Nature- Structure- Architecture

While the scale, function, and processes observed in nature are different to those found in architecture, the constraints and objectives (functionality, optimization, and cost effectiveness) are very similar. Therefore, it is no surprise that mankind has always admired biological structures and has often been inspired by them, not only in their aesthetic attributes but also in their engineering and design qualities and efficiencies.

When the interaction between nature and architecture is studied, it can easily be seen that the interventions between what architects design and what exists in nature are very complicated, ranging from materials to construction techniques, from

structural systems to aesthetics. In this section, firstly the structures inspired by those in nature are categorized according to their animate and inanimate nature, and again according to their visual/formal similarities. Following this categorization, examples are presented to illustrate the similarities between natural and man-made structures using a number of benchmark examples from the history of architecture.

3.1.2.1 Classification of Structures in Nature

Nature exhibits a diverse variety of structures, and generally the form and visual qualities of nature's animate or inanimate forms have evolved due to internal and external environmental forces, and static and dynamic loadings. This complex formation process and duality of form and structure make it difficult to compare man-made structures with those in nature. Hence, it is necessary to establish criteria for further analysis of man-made designs and forms observed in nature in a systematic way. In the next section, some categories are presented regarding the structural behavior and the formal/visual characteristics of animate and inanimate formations in nature, and major structural systems observed in many architectural designs are compared within the bounds of these categories. In this categorization, structures produced by animals (Hansell, 2005) can also be included within the animate nature.



Figure 3.1 Examples from inanimate nature (Source: Otto, 1995)

Objects in non-living nature - simple atoms and molecules, crystals, rocks, mountains and waters, stars and galaxies etc. - constitute a set of characteristic

forms and structural properties (Noel, 1978). The processes of formation shape their final forms, by which the structural system is shaped with material properties, and static and the dynamic internal and external loadings of the environment in which they should stand, e.g. by the laws of the physical universe. The analysis of structures in non-living nature show that in their development only a limited number of formation processes take place: the accumulation of masses, the movement of large masses, the flow of liquids and gases, and the solidification of matter into solid bodies. Yet those inanimate structures have extremely long life spans when compared with the life span of any animated form. One of the important non living nature examples in architecture can be considered as the polyhedrons (Platonic Solids) inspired from stars, crystal like structures in prisms, antiprisms, geodesic domes, and folded plate structures tensegrity structures, as well as space frames applications.

Animals, plants, and microorganisms are the “living structures” found in nature. They are able to assimilate and transmit forces with little expenditure of material and energy, even in their short period of existence. It can easily be seen that the world of animate nature is absolutely diverse, mobile, and mutable, and is diverse when compared with inanimate nature. Another important categorization of the structures in nature can be introduced in relation to load bearing capacities, as in the case of man-made structures.

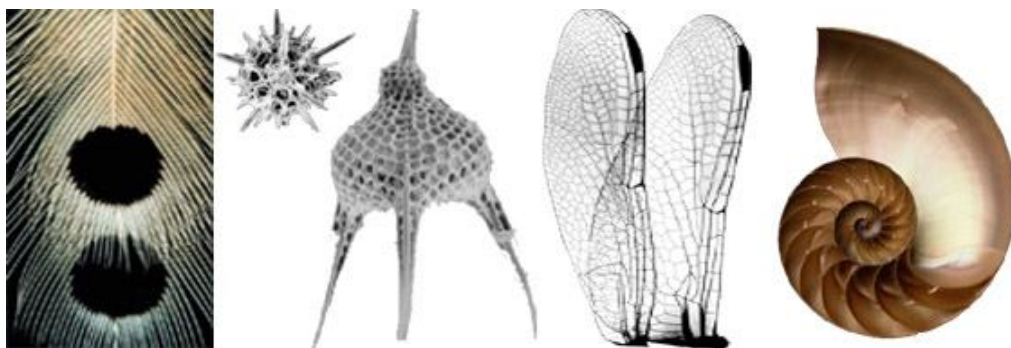

Figure3.2 Images from animate nature (Source: image library of CorelDRAW® Graphics Suite X4)

It is observed that one-dimensional natural structures are mostly lightweight elements, such like tension-stressed fibers, hairs, sinews, muscles; and compression and bending-stressed stalks, trunks, branches, bird feathers, and bones. Membranes of cells, skins, intestines, and spider webs can be considered as two-dimensional structures that are resistant to tension, exhibiting membrane or shell characteristics that are able to transmit forces through their surfaces. Structures composed of tension and compression-stressed elements, such as the wings of insects, bats, and birds etc. can be considered as two-dimensional, however most of the structures in living nature are three-dimensional. Many compression and pressure stressed structures, like vertebral bones and compression and bending-resistant skeleton systems of trees and bushes, the spongiosa inside bone, and the three-dimensional skeletons of radiolarian, can also be included in this categorization. The bodies of many animals consisting of tension, compression, and bending-resistant elements are also three-dimensional.

All structures used in architecture belong to one of these categories, depending on the forces that they are subjected to. In a building, the structural elements can vary from one-dimensional tension or compression members, to plates and shells to support a diverse variety of internal and external loads, as is the case with structures in nature. Any structure in nature and any man-made structure should withstand similar forces and loads. Thus, it is very natural to draw inspiration from nature in the design of new innovative structures.

3.1.2.2 General Taxonomy of Architectural Structures Inspired by Nature

Developments in science alter the way the process of life is perceived in physical nature. An analytical approach to natural and cultural phenomena emphasizes the basic characteristics of the modern age. Nietzsche says that "*scientific method distinguishes the nineteenth century*" (Korkmaz, 1998). Therefore, an analytical approach to nature is achieved through "scientific method." Method means the type of researching the objects within the limits of objective research areas. Scientific method is a body of techniques for investigating phenomena and acquiring new knowledge, as well as for correcting and integrating previous knowledge. It is based on gathering observable, empirical and measurable evidence subject to specific

principles of reasoning, the collection of data through observation and experimentation, and the formulation and testing of hypotheses⁸. When it is possible to test and interpret the world in nature by numbers, then it may be possible to understand the process of structuring and use those ideas in nature to the advantage of mankind, which is the basic aim of Biomimetic researchers. In architectural discourse the break between the ancients and moderns occurred in the 19th century, when the question being raised by architects changed from “what” to “how”, that is from the object to the process. This change allowed researchers to discover new architectural and structural solutions derived from the observations of the natural environment.

Following these researches, a new formal understanding and aesthetic of the architectural entity emerged in the 20th century. Structural aesthetics changed with the new basic principles. Gropius, the founder of the pioneers of this theme, Bauhaus, claims, “...as history shows, the concept of beauty has changed along with progress in thinking and technique.” (Hartoonian, 1994). A similar statement is made by Nervi “...every improvement in the functional and technical efficiency of a product brings about an improvement in its aesthetic quality (Holgate, 1986). For Nervi the result is a truthful style, and its characteristics are structural essence, a necessary absence of decoration, and a purity of line and shape. If a building is correctly designed in its structure, its beauty shines from the correctness of the structure. It is not a matter of which material you use, but how you use it.

It is possible to claim that innovation derived from technology, new modes of calculations, computation, and new theories have been developed by the architect's intuition. Developments of structural design in the Modern Movement employ several theories from different disciplines, like mechanics, pure mathematics, civil engineering, the use of new materials, and the architect's intent. Knowledge of building technology changes from being a craft to a scientifically-designed entity, and there is a tendency to use mass produced rather than natural materials. Knowledge of materials also raises an opportunity to explore more challenging and innovative structures. In this respect, several structural systems that have been

⁸http://en.wikipedia.org/wiki/Scientific_method#_note-0

developed allow spans of larger distances than ever before. It is important to mention that these structures show the similarities between structures in nature and man-made structures.

In this study, structures are classified into five main categories, namely, tree-like structures, web-like structures, shell-like structures, skeleton-like structures and pneumatic structures. Pioneering examples of each category belonging to different periods of architectural history are presented. Through an analysis of these examples the visual similarities in man-made structures and structures in nature are discussed in the context of Biomimesis.

3.1.1.2.1 Tree -Like Structures

In the tree, nature has presented the concept of growth and multiplication in which the sequence of trunk, branch, leaflets, and leaves exemplify patterns which are very similar to those governing architectural orders. In the categorization of structures according to their formal/visual characteristics rather than their load carrying capacity, the first category appears to be tree-like structures. Throughout history, trees have been significant for mankind, being the preferred choice in the provision of many needs, from heating to housing. Observations of tree-like structures led man to gain knowledge in new constructional methods and structural systems to satisfy their needs. When historical architecture is examined, a very deep and developed intuitive knowledge of construction becomes visible. According to Portoghesi, the tree has taught man the concept of growth and multiplication, since ramification lies at the very hearth of its nature. The branched support tree-like structure can be first observed in the ribs of the Gothic style, while today tree-like structures in architecture are mostly three-dimensional support systems, which have been used increasingly in steel, wood, and concrete buildings.

One of the oldest examples of a tree-like structure is the Eddystone Lighthouse, Southwest of Plymouth (1759) by John Smeaton. Smeaton's model was based on an English oak tree, which he considered as having the best configuration to resist the forces of nature (Addis, 2001). Similarly, Antonio Gaudi, who practically never journeyed anywhere, drew his inspiration from his ability to observe and reuse the

countless details offered by nature. When one enters the crypt of Sagra da Familia in Barcelona, the four inclined basalt columns standing out give the sensation of an organic and natural structure, like trees in a forest.

In the 1970s, great interest was given to architectural structures derived from the ramification concept in nature. Frei Otto studied the “minimum path system” to investigate a form for compression-loaded ceiling and roofing (Roland, 1970). Otto claims that the fan structure (a) as used in timber and steel building can be addressed as a materialized direct path network. The branched fan construction (b) is more effective in many cases as the buckling lengths of the compression members are reduced; while the tree branched structure (c) is a materialized path network with minimum detours, needing a relatively small amount of material and with a load bearing capacity that can be increased by thin branches (d) Figure 3.3 (Otto, 1995). Several structures were constructed by Otto following this concept, and by later architects following his design principles.

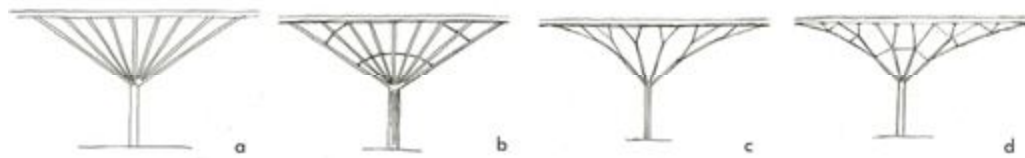

Figure 3.3 Branching theory of Frei Otto (Source: Otto 1995)

In today's architecture, tree-like columns are very common due to developments in the steel industry and CAD-CAM technologies. BCE Place (1987) was designed as a mixed-use complex in Toronto by Santiago Calatrava. The structure of the complex comprises eight inwardly-inclined steel supports bifurcated upward, eventually meeting to form pointed parabolic vaults spanning 14 meters across the interior space. Over a 30-by-3-meter regular plan, tree-like structures rise and support nine intersecting barrel vaults, creating a “forest” effect (Tzonis, 1999). Rather than resorting to the imitation of these precedents, however, Calatrava reinterprets them as “forests” of structural “trees.” This forest effect in Calatrava's designs is very common, and can be found in the Bauschanzli Restaurant, Zurich

(1988), the Cathedral of St. John Divine, New York (1991), Oriente Station, Lisbon (1993-98), and the Reina Sofia National Museum of Art, Madrid (1999).



Figure 3.4 Examples from Calatrava's tree-like structures BCE Place, Bauschanzi Restaurant Oriente Station (Source: Zardini, 1996)

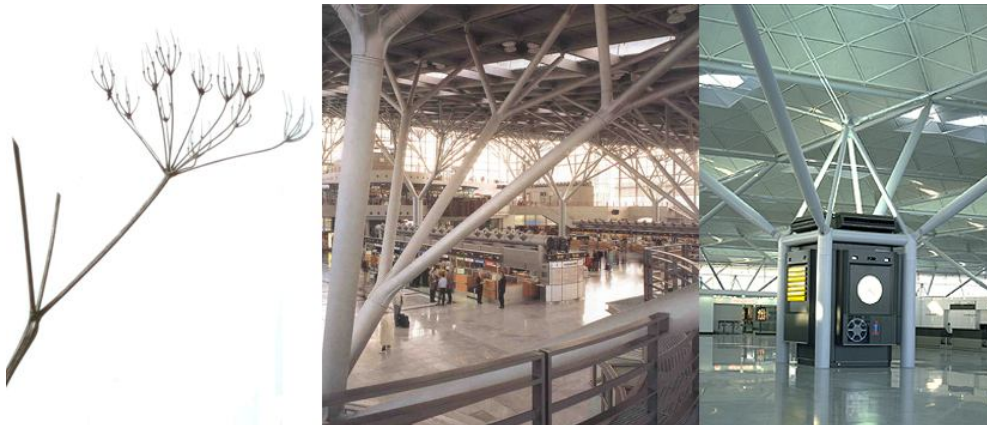

Figure 3.5 Examples from contemporary tree-like structures Stuttgart Airport Passenger Terminal (Von Gerkan, 2007), Stansted Terminal (Foster and Partners, 2005)

The roof of the Stuttgart Airport Passenger Terminal, Germany (1996), designed by Meinhard von Gerkan, is among the contemporary examples of tree-like structures. The huge sloping roof is supported by 12 very tree-like steel structures, in which the loads can be seen to be descending through an elaborate hierarchy, from twigs to

branches to trunks, all fundamentally in compression. More directly, the construction of the terminal roof is based on the structure of a tree, thus providing an unmistakable and individual feature for Stuttgart Airport (Figure 3.5).

There are a vast number of examples of tree-like structures that can be found in the history of architecture, all of which exhibit the main architectural and technological characteristics of their period. Besides those examples there are many other progressive architects who have been influenced by trees in their designs, whether consciously or not.

3.1.1.2.2 Skeleton-Like Structures

When most animals are examined, every bone of the skeleton, and the skeletal system itself, show how nature has formed a sophisticated, lightweight, and rigid structure that is perfectly suited for kinetic design. Since the main structural elements of buildings are based on the spine, as is the case in animals, it seems obvious that a further less-dominant structural element should be based upon the ribs. In nature the spine and ribs work in conjunction with one another to provide support and protection. This idea seems plausible for buildings as well. Ribs provide support for the roof and create enclosure in the form of a building. While designing the famous Eiffel Tower, Maurice Koehlin, assistant to the architect, was inspired by the femur, the lightest and strongest bone in the human body, with self-ventilation properties due to the porosity of the bone material, as shown in Figure 3.6. Buildings designed and constructed similar to this bone optimize the construction material, and also provide firmness and flexibility in the skeleton of the construction (Williams, 2003).

Again, Gaudi, in Casa Battlo (Barcelona 1905-1907), showed natural and organic forms which were no longer ornaments superimposed on the building, but constituted essential structural elements, as in the case of bone-shaped columns shown in Figure 3.6. As a contemporary example, Nicholas Grimshaw's addition to Waterloo Station, which can be likened to the human hand, can be presented (Grimshaw, 1993). The cupped "hand" reaches across the track to make an

enclosure of the space. Study of the conceptual sketch of the hand can easily reveal the influence of the skeletal structure on the structure of the building.



Figure 3.6 Images from skeleton-like structures Eiffel tower and femur (Source: Williams, 2003), Casa Battlo (Source: Masso, 1999), Waterloo Station (Source: Grimshaw, 1993)

Santiago Calatrava has also used features of animal shapes and skeletal structures in the design of many of his bridge and building projects (Williams, 2003; Sharp, 1994). He understands how a body varies in order to accommodate its various parts and forces through identical rib-like pieces, which are less expensive to manufacture and yet have a high capacity to carry uniformly distributed loads when they are employed in man-made structures. Calatrava could possibly be considered the master of today's skeleton-like architecture.

3.1.1.2.3 Web-Like Structures

In the categorization of structures found in nature, web-like structures have another importance in addition to their load carrying capacity that arises from their silk-like quality. Spider silk is stronger and more elastic than Kevlar, the strongest man-made fiber (Shear et al, 1989). Web-like structures exhibit membrane characteristics in their load bearing features. Moreover, their load carrying capacity is extremely high, and yet the structure itself is lightweight. Tents, which are basically man-made membrane structures, can be considered similar to those web-like structures in nature (Beukers, 1990). Drawing influence from the tents of indigenous people of different regions, a very early example of large-scale use of a membrane-covered

tensile structure can be seen in the truss-roofed exhibition pavilions constructed for the Nizhny Novgorod Fair of 1896 by Vladimir Shukhov, and the Sidney Myer Music Bowl, constructed in 1958 (Kronenburg, 1996).

In the 1960s, Frei Otto, who studied the similarities between tents and web structures, was the pioneer architect of tensile construction. He improved his new concepts by focusing his investigations on one of the principal forces encountered in a structural system - tensile stresses. The modern tent is principally based on Otto's studies and designs and can be compared to a spider's web in the way it uses strength and grace together. It is a perfect example of using the minimum amount of material to cover a vast area. Traditional tents were revived by Otto as a leading prototype for lightweight adaptable buildings (Otto, 1995).



Figure 3.7 Web-like structures in nature (Source: <http://www.hainaultforest.co.uk>) and architecture (Source: <http://www.panoramio.com/photo/9972384>)

Innovative structures with extreme lightness have been developed by Otto throughout his studies. Since the 1970s, web like structures have been championed by designers and engineers such as Ove Arup, Buro Happold, Eero Saarinen, Horst Berger, Matthew Nowicki, Jorg Schlaich, the duo of Nicholas Goldsmith & Todd Dalland at FTL Design & Engineering Studio, and David Geiger (Robbin, 1996). Steady technological progress has increased the popularity of fabric-roofed structures. The low-weight materials make construction easier and cheaper than conventional methods, especially when large open spaces have to be covered.

3.1.1.2.4 Pneumatic Structures

Pneumatic structures, which occur both in inanimate and animate nature, can easily be found in a variety of forms of animate nature, plants, and animals in various life processes and conditions. Pneumatic structures have been developed and built up through countless variations of a single construction principle, namely, the principle of the “Pneu”, which is a system in which a tension-resistant, flexible envelope surrounds a filling (Dent, 1972) The envelope and the filling together form a load-bearing structure.

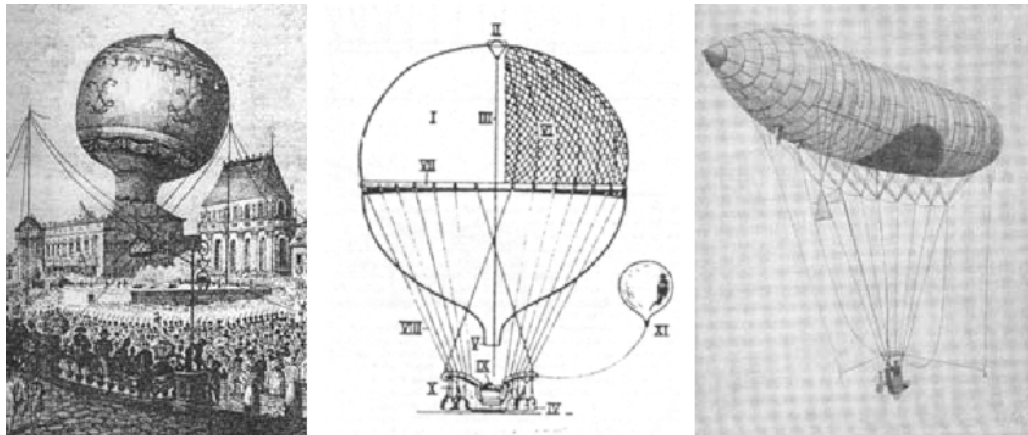

Figure 3.8 (a) Montgolfier Brothers' hot air balloon (1783) (Herzog, 1977) (b) Jacques Charles hydrogen balloon (1783) (Herzog, 1977) (c) Santos-Dumont No 1 Dirigible (1898).

The first experiments with pneumatic structures were undertaken during the development of hot air balloons. Brazilian priest Bartolomeu de Gusmão conducted a pioneering experiment as early as 1709 in Lisbon. At the end of the 18th century the Montgolfier brothers built an 11 meter diameter hot air balloon made from linen and paper. Jacques A. C. Charles, the father of the Zeppelins, began construction of the first hydrogen balloon, a large rigid dirigible, at the end of 19th century (Herzog, 1977; Forster, 1994).

From an architectural point of view, the best of our present knowledge starts with English motorcar manufacturer Frederick William Landhester, who first recorded the idea of supporting tents through internal air pressure in 1917. During World War II, and following the invention of *nylon*, the idea started to be used by the military for

emergency shelters (Topham, 2002). In the following years, pneumatic constructions and their use of air as a supporting medium became a part of architectural language. The study of air bubbles formed in liquids is undoubtedly nature's most relevant precedent in the design of pneumatic building construction, and this approach was a starting point for Frei Otto. Systematic research and development of the form, finding processes of technical pneumatic constructions by Otto and his team resulted in progress in the development of new structural systems having roots in pneumatic forms in nature, allowing the construction of many innovative building forms. Through the IASS Pneumatic Colloquium (University of Stuttgart, 1967) and several publications and designs, Otto broadened the landscape, not only of pneumatics, but of tension structures in general. Pneumatics was also part of the repertoire of Richard Buckminster Fuller, whose proposal of a pneumatic dome to cover New York (Figure 6) is a famous example of Utopian pneumatic architecture (Baldwin, 1996). At the end of the 1960s, the Paris group Utopie, which included architecture students Jean Aubert, Jean-Paul Jungmann, and Antoine Stinco, and sociologist Jean Baudrillard, among others, formulated criticisms on architecture, urbanism and the daily life of French society. They were also influenced by the Archigram Manifesto and reinterpreted the aesthetic of pneumatic structures, using them as a form of social expression related to ephemerality and mobility, in contrast to the inertia of the postwar European society (Dessauce, 1999). The use of pneumatic structures, such as the Fuji and American Pavilions in exhibitions, reached a peak at Expo '70 in Osaka, Japan, when they were widely adopted due to the poor quality of the soil and high seismicity of the region. Another interesting example is provided by the Floating Theater, which was realized by the same team that produced the Fuji Pavilion. The structure was composed of three inflated tubes, highly pressurized and connected by a single layer membrane, with the inner space kept under a negative pressure, thus providing a rare case of an aspirated pneumatic structure (Wilkinson, 1996).

David Geiger developed several projects employing cable reinforced, insufflated membranes for sports stadiums in the United States and Canada from 1974 to 1984. The largest of these stadiums are the Pontiac Silverdome in Michigan (1975), the Vancouver Amphitheater (1983) and the Minneapolis Metrodome (1982), all of which cover more than 40,000m² with capacities of more than 60,000 seats (Foster,

1994). Likewise, in the 1990s this structural system was very popular for large-span roofing, such as in the Big-Egg Dome in Tokyo (Figure 3.9), the Expo' 92 German Pavilion in Seville, and the Nimes Roman Arena in Rome.

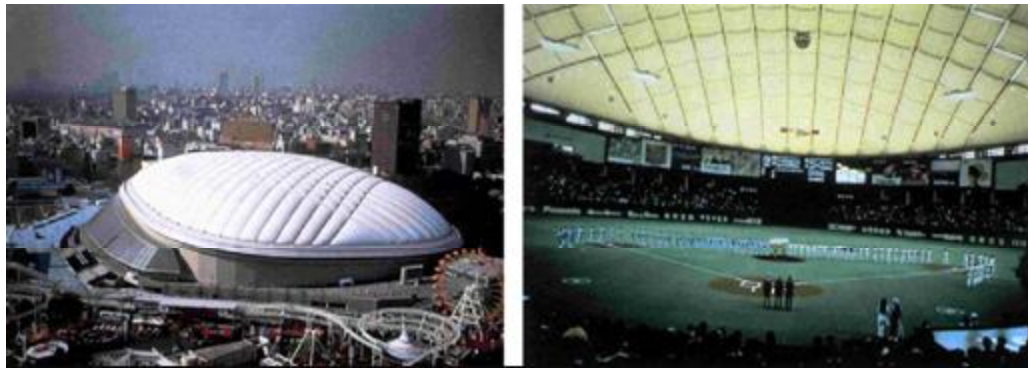

Figure 3.9 Tokyo Big-Egg Dome (Source: Forster, 1994)

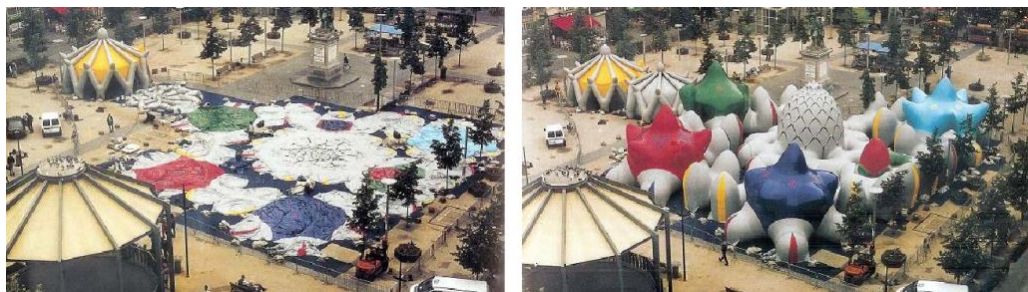

Figure 3.10 Archipelago, by Architects of Air (Source: Topham, 2002)

In today's architecture, pneumatics are frequently used in smaller and ephemeral/temporary buildings, more for aesthetic than economic reasons, since their futuristic and revolutionary appearance usually provokes fascination among observers and users. The pneumatics return is even more impressive in the field of object design, as there are fewer constraints in the exploration of new shapes, especially with the aid of the modern computerized design tools and the availability of high tech materials. Eloquent examples are given by the colorful and organic pavilions of Maurice Agis or the Architects of the Air and Buildair offices. (Figure 3.10)

3.1.1.2.5 Shell-Like Structures

Shells are among the most common and most efficient structural elements in nature and technology because of their high resistance, minimum material, large spanning capacities and sheltering characteristics. Examples of shells in the morphology of nature are particularly abundant. (Melaragno,1991). Many great artists were inspired by the beauty, diversity and design of the shell, that they incorporated them into their masterpieces. Architecture has been profoundly influenced by the geometry and sheltering capacity of these 'natural wonders' done by snails, clams, scallops, and other marine mollusks. Many scientists could not avoid themselves to study of shell shapes from mathematical and geometrical point of views.

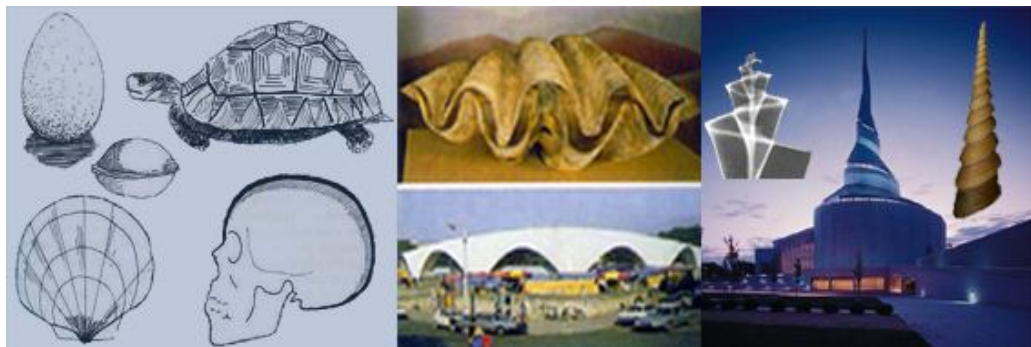

Figure 3.11 Shell examples from nature and architecture (source: Melaragno,1991, Senosiain, 2003, Chiat, 2004)

The discovery of cement made possible the realization of new architectural designs using thin shells in structural systems. Moreover, the advent of concrete as a new building material at the beginning of the 20th century strongly influenced the conventional way of construction and the design of new domes. In the 1920s, the first examples of reinforced concrete shells were introduced by Franz Dischinger and Walter Bauersfeld, evoking a comparison of their domes with eggshells. The technology developed by Dischinger, Finsterwader, and Bauersfeld in the 1930s was compatible with single-arched structures, and following this, further developments in the analysis of these forms and their manufacturing processes made possible the building of more complicated forms, such as double-arched

saddles (Gössel & Leuthauser, 1991). Later, many other engineers and architects, such as Robert Maillart, Eduardo Torroja, Eugène Freyssinet, Pier Luigi Nervi, and Felix Candela were to design and apply technically appropriate and elegant solutions to reinforced concrete constructions. Among them, Nervi and Candela brought some solutions to their designs that were inspired by structures in nature.

To conclude, as seen from the taxonomic diagrams (Table 2.2 and Table 3.1) and the examples chosen from different periods in architectural history, man-made structures are deeply influenced by structures in nature. Many progressive architects and engineers have been inspired by nature – by both animate organisms and inanimate structures. This inspiration led some architects, such as Otto, Fuller, and Candela, to establish institutes to research natural structures and patterns. They contributed to architectural design and the development of new structures based on structures in nature. Apart from these names, the general tendency of the “nature-architecture relationship” stayed only as a source of inspiration for architects. Examples from these two approaches reveal that nature has always been a part of architectural design, either implicitly or explicitly, and architects have found clues in nature for new designs and technologies. Hence, in the world of architecture nature has and will always be a source for the next generation of designs, as has been the case in the past. Using nature as a source of stimulation in architectural design was given several names in different architectural periods. Nowadays, this concept is discussed within the realm of “biomimesis in architecture”. This terminology implies that nature-architecture interaction can go beyond the “form finding process” and can be a “learning interface”, having its own systematic with objective design parameters - as in many other disciplines - changing design the paradigms for architecture. It is widely accepted that Biomimesis has more potential and can contribute to (re)experience and the creation of forms-structures-materials etc. as it is observed in nature, providing not only flexibility in the creation of form, but also in function and efficiency in the fulfillment of function.

Table 3.1 Diagram representing architectural structures inspired by nature

		architectural structures inspired by nature					
		nonliving	living				
		polyhedrons	tree-like structures	pneumatic structures	web-like structures	skeleton-like structures	shell-like structures
prior periods		egyptian and maya pyramids	tree trunk as a structure classical column 1567				roman domes byzantine domes islamic domes renaissance-baroque domes
		neolithic period carved stones 2000 bc	eddystone lighthouse 1759	hot air balloons 1709	tents		
1800's		bronze dodecahedron 200bc basilica of san marco 1425 de divina proportione da vinci 1452	columns in sagra da familia 1883		nizhny novgorod fair 1896		from masonry to concrete thin shells
		planet of jupiter düerer 1471 mysterium cosmographicum kepler 1571 stars escher 1898 corpus hypercubus dali 1904 geodesic dome fuller 1920 convent of saint marie le corbusier 1920 the one-family house botta 1950	branching theory 1970 bce place 1987 bauschanzli restaurant 1988 cathedral of john divine 1991 oriente station 1993 stuttgart airport 1996 ciutat de les arts les ciències 1996	supporting tents by air 1917 emergency shelters 1945 fuji-american pavilions 1970 floating theater 1971 pontiac silverdome stadium 1975 minneapolis metro dome 1982 vancouver amphitheater 1983 1988big-egg dome 1996airtecture 1998cocoon	sidney myer music bowl 1958 hamburg garden exhibition 1963 german pavilion montreal 1967 munich summer olympics 1972 hajj terminal 1978 munich hellabrunn zoo 1980 sandiego convention center 1983 denver international airport 1995	eiffel tower 1887 columns in casa battlo 1906 animal houses 1989 waterloo station 1993 milwaukee museum 1994 lyon airport station 1994 tokyo international forum 1996	1913centennial hall 1957sydney opera house 1916airship hangar at orly 1934hayden planetarium 1939swiss exhibition 1951cosmic reays library 1955kresge auditorium 1956waikiki shell 1957small sport palace 1958xochimilco restaurant 1959cnit 1962twa aterminal 1966church santa monica 1970focus cinema 1975yakima valley sundome 1976kingdome stadium 1976biodôme 1980thompson arena 1996valencia opera house 1996oceanographique 1998city of arts sciences
2000's		prisms antiprisms folded plate structures tensegrity structures space frames hypercube	columns of new milano fair 2002 mission valley branch library 2003	2000airquarium 2001pneumatrix	sainsbury commercial center 2000 weihai stadium china 2002	peabody essex museum 2003 turning torso 2005	2000sondika airport 2000wales botanic gardens 2000illinois assembly hall 2003csanta cruz de tenerife 2003messehalle freistadt 2007admirant

As it is clear from the Table 3.1 shells have been widely used in architecture and have always been a subject of interest due to their high structural performance and their potential to provide clear spaces. Furthermore, shells in nature, which has always been a subject of interest for architects due to its forms, functions, structural behavior, and materials, is very convenient to inquire into the efficiency in form-structure and material usage relationship that biomimesis force us to understand. Shells are also fitting to question “multi-dimensional” properties of natural structures and to understand the natural processes that have resulted in the formation of the final configuration of the structures in nature. For this purpose, after previous taxonomic study on architectural structures inspired by nature, the following sections of this chapter concentrates on shell structures in architecture. Firstly a research on shell definitions, the origins of man-made shells, and shell types in architecture with pioneering examples are given. Then an overview of analytical and numerical methods in shell analysis is to be presented to set a base knowledge for further discussions.

3.2 Contemporary Biomimetic Approach in Architecture: A Case on Shell

There are numerous shell structures in nature, of which eggs, skulls, nuts, turtles, and seashells are some notable examples, and which have been source of inspiration in architecture. As mentioned earlier, shells are common and highly efficient structural elements in nature and in the built environment due to their high strength, large spanning capacity, minimum material usage, and sheltering characteristics, emerging from its form-function-structure and material synchronicity.

A shell's structural behavior is derived directly from its form, thus in the design of a shell-like structure the fundamental consideration is geometry. This not only dictates the esthetics, but the overall efficiency and behavior of the structural system as well. Hence, it is believed that in this study shell structures will provide a base for further discussions of biomimesis and its possible implementations in architecture.

3.2.1 Definitions on Natural and Man-Made Shells

The dictionary defines a “shell”⁹ as “usually hard outer covering that encapsulates certain organisms, such as mollusks, insects, and turtles; a hard rigid usually largely calcareous covering or support of an animal; or the hard or tough often thin outer covering of an egg and the hard usually fibrous outer layer of some fruits especially nuts”.

As seen from the definition, the word shell is commonly used to describe external, usually hard, protective, or enclosing case or covering in nature. Similarly, in man-made products the word shell is used to define a rigid covering that envelops an object or a framework or exterior, as of a building. According to Kelker and Sewell (1987), while designing any structure, designers always aim to achieve economy by minimizing costs within the functional and aesthetic requirements. Furthermore, they try to evolve new forms with convenient materials that resist the loads more efficiently than when the structure is designed in a conventional form.

“...for covering a given area by a roof, designing a slab and a beam structure requires slabs spanning on secondary beams which themselves span between the main and beams supported on columns. As column spacing becomes larger and larger the sizes of the beams increase, consequently, making the structure uneconomical and aesthetically unpleasing. Alternatively, to cover the same area, it can be conceived a curved surface that carries the loads mainly in direct compression or tension, rather than in bending and in shear as done by the slab and beam structure. With a relatively small thickness, such curved stress can sustain large loads over large column free areas with a minimum of deflection. The behavior of such surface structure can be compared to that of a soap film membrane which covers a large area with extremely small thickness, or to that of an eggshell, which resist considerable pressure in spite of being very thin. Such curved surfaces, which have thickness that are small compared to other two spatial dimensions, are called shells...” (Kelker and Sewell, 1987).

⁹Definition of shell, <http://www.thefreedictionary.com/shell>.

As explained above, shell structures are greatly superior to conventional column-beam structures when seeking to cover large spans with minimum material. In wide spans, carrying capacity compromising live and dead loads is very efficient in shells. Although shells have the most complex structural behaviors they are still the most effective form.

“...In the pre-industrial age, the structural form for the wide spans was the masonry vault and dome. The development of reinforced concrete in the late 19th century made the maximum span possible with the compressive form-active type of structure. After that shells are considered one of the most important developments of 20th century in architecture and in other industrial products.” (Melaragno, 1991)

Like the arch, other curved shapes often used in concrete shells allow the spanning of wide areas without the use of internal supports, giving an open and unobstructed interior. The use of concrete, which is inexpensive and easily cast into compound curves, reduces both material and construction costs.

Such potentials and pros have made shells a source of inspiration for architects, and thus they are encountered very frequently due to their high structural performance and potential to provide shelter, not only in natural organisms but also in man-made applications.

Among the many interesting aspects of the shell in technology, engineering, and architecture, one stands out as being of utmost importance: that shell forms are shaped according to the loads that they are exposed to (Zannos, 1987). The theory of these structures tends to deal with the mathematical models, stripped of many of the characteristics that make them recognizable as useful structural systems in many fields. The following section explains the origins and the general usage of shells in technology, engineering, and architecture in order to develop a clear understanding of how widely those structures are being used.

3.2.2 The Origins of Man-Made Shells

When man as creator uses his hands and mind to shape the physical world, he often finds a source of inspiration in the breath of creation manifested in nature. Either by artistic intuition from physically observing nature as a scientist, man creates structures realizing that he has two bases from which to operate: form and the reality of the materials. (Melaragno, 1991)

The origins of the man-made shell can be traced back to masonry vaulting, and timber and masonry domes. Two basically different roots stand at the origin of the construction of vaults and domes, one stemming from a psychological need; the other from technological evolution in the art of the building. These aspects that merge to create man-made curvilinear shells constitute a common cultural foundation, shared by the creative, artistic mind and its logical, scientific, technological counterpart, which ultimately have the same goal of designing structures for human habitation (Melaragno, 1991).

In the history of architecture masonry arches, vaults, and domes reflect certain structural necessities through their characteristic thickness. Their thickness was dictated by the materials used - stone, brick and mortar joints. Their inability to resist tensile stresses required a widening of their cross-section so that compression would reduce the effect of potential bending. Substantial thickness was often intuitively felt necessary to prevent buckling, thus masonry vaults and domes never attained the daring slenderness of concrete.

The birth of thin shells in architecture can be accepted as the discovery of cement, which made reinforced concrete possible. With the invention of reinforced concrete and developments in analytical and computational methods, the applications of curved forms reached their golden age. Some examples of man-made shells, which are effective in the use of both material usage and structural behavior, approximated those found in nature. The successes of these new curved structures are based on the ability of reinforced concrete to carry tension as well as compression.

3.2.3 Basic Structural Properties of Shells and Their Use in Architectural Applications

“Shells in architecture” are curved structures capable of transmitting loads in more than two directions to structural supports. Their surfaces are shaped so as to respond to loading primarily through the development of tensile and compressive membrane forces and shear stresses, and are made out of such inelastic materials as concrete, wood, metal etc.¹⁰.

There are several definitions and theories explaining the complex behavior of shells. A widely accepted theory of shells was developed by Vlasov, 1951, whose definition of the thickness of shells describes them as “thin” when considered with respect to the thickness of the other elements of a shell. A shell is a curved surface thin enough to develop negligible bending stresses over most of its surface, while being thick enough not to buckle under small compressive stresses. These structures can be very thick, thick, moderately thick, thin, and very thin, and the 3D solid effect decreases and the stretching effect increases respectively. Heino Engel, in his book “Structural Systems” (1997), classifies man-made structural systems according to their structural forms and behaviors as form-active, vector-active, section-active, surface-active, and height-active. In this categorization, shells are described as “surface-active structures”. He argues that surfaces are the most effective and the most intelligible geometric means of defining spaces. The surface structure, when certain structural properties are given, can perform its structural functions without additional support members (Engel, 1997). A surface-active structure simultaneously envelopes the internal space and the external building, determining the form and space of architecture. Similarly, form resistant structures (Salvadori, 1975) are those based on the principle that loads are carried through the shaping of the structural surfaces. The new carrying capacity is obtained not by increasing the amount of material used, but by giving it a proper form. Included in these structures are compressive shells, tensile cable networks, and air-supported tensile membrane structures. From this viewpoint shells are surface-active and form active structures.

¹⁰ The author acknowledges the valuable guidance of Dr. Chris Williams from the Department of Architecture and Civil Engineering at the University of Bath, who helped in explaining the terms and definitions of shells.

Another classification based on the geometric properties of the shell was put forward by Melaragno (1991), who gave names to the most frequently used shell forms in architecture, namely barrel shells, spherical domes, conoidal shells, cantilevered shells and hyperbolic paraboloid [hypar]. The combined effects of mass and geometry are major factors in the structural strength of shells. Generally, these shell structures can be divided into two main classifications: **singly curved**, in which the curvature is in only one direction, and **doubly curved**, in which the curvature is in both directions.

Barrels are singly curved shells, formed by bending a flat plane, and are the most typical shape of a developable shell that is curved only in one direction. The most commonly used shapes for barrel shells are semicircular or parabolic (Billington, 1996). Due to their ability to resist tension they can be supported only at the corners and are therefore unlike the barrel vaults due to their ability to resist tension. Another important point to note about barrel shells is that they can be used to span longitudinally as well as along the shorter span. An example of the architecturally effective use of concrete barrel shells can be found in the Kimbell Art Museum (1966–72), Fort Worth, TX (Antoniadis, 1992).

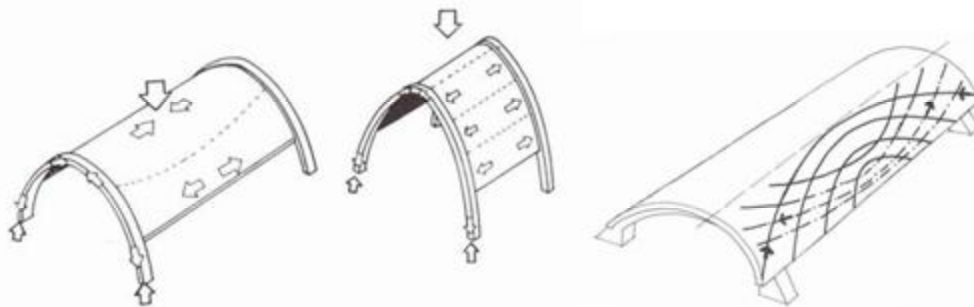

Figure 3.12 Behavior of barrel shells and transmission of the forces to the supports (Source: Melaragno, 1991: 131-132).

According to Melaragno *et al.* **doubly curved** surfaces can be further subdivided into *synclastic* and *anticlastic*. The curvature of a shell can be of the same sign throughout, that is, be concave or convex everywhere. In such a case, the surface is called synclastic. In synclastic shells, the centers of both curvatures are located on the same side of the surface. The spherical dome is an example of a synclastic

shell, because any section attained by intersecting the dome with a normal plane produces a line that has only a downward curvature. The curvature of a shell can also be of a different direction, such that the surface is both concave and convex at the same time, which is known as anticlastic. In anticlastic shells the centers of curvature in the two directions are on opposite sides of the surface. Hyperbolic paraboloid (hyper) and conoidal shells are examples of anticlastic shells (Ketchum, 1997). When such a surface intersects with normal planes, the sections formed can be a parabola with either upward or downward curvature, and at times can even be a straight line.

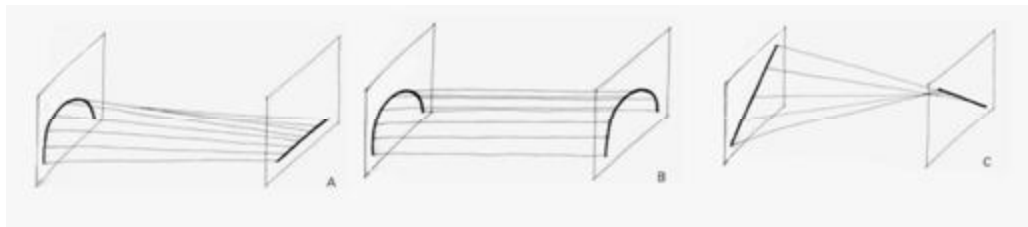

Figure 3.13 Three basic shapes of conoidal shells (Source: Melaragno, 1991: 133).

Cantilevered thin shells constitute their own subgroup within the larger family of shell structures, one that is distinct in terms both of geometry and of structural behavior. Such shells have more lightness than any other cantilevered structure. The fact that their means of support are unclear to the typical observer creates an illusion of loftiness, capable of inspiring a sense of wonder and admiration (Salvadori, 1972).

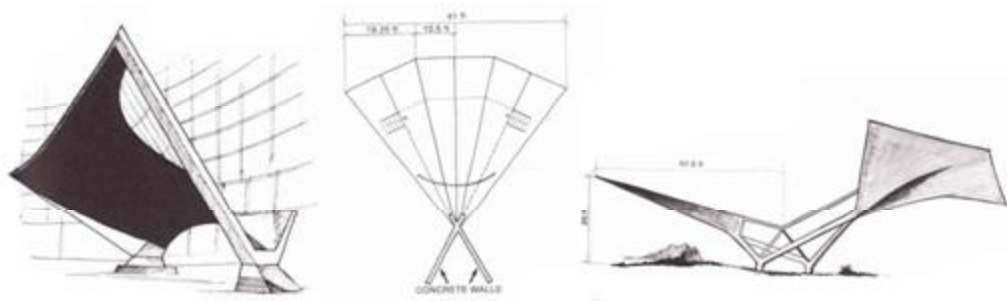

Figure 3.14 Examples from cantilevered shells (Source: Melaragno, 1991: 136-137).

In a hyperbolic paraboloid [hypar] the surface is generated by the movement of one parabola on another parabola of opposite curvature. Its surface is one of the most structurally efficient of all surfaces. It has an “arch” action in one direction and a “cable” action in the other. The thrust of the arch action and the pull of the cable action at the edge beams results in compressive forces that act down the edge beams to the supports (Melaragno, 1991: 141). Many architectural shell buildings have been constructed in the last century using all these shell types. The following section contains a number of examples, including experimental shell structures, from the 20th century.

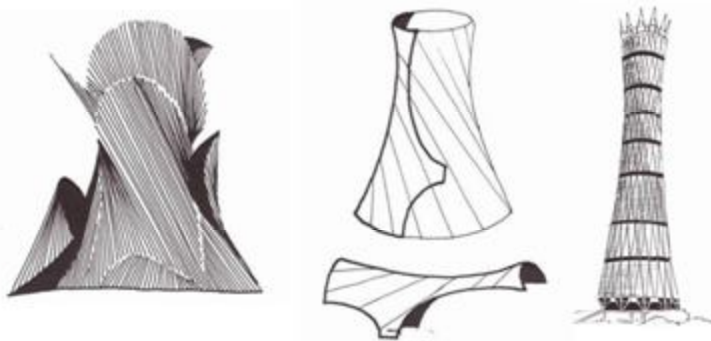

Figure 3.15 Examples from hypars in architecture (Source: Melaragno, 1991: 136).

A further classification can be made according to the material properties of shell structures. Thin shell theory is assumed to be homogenous, isotropic, and linearly elastic regarding the use of concrete materials.

With all these shell types many architectural shell buildings were constructed in the last century. The following part covers some examples including experimental shell structures of the 20th century.

3.2.4 Experimental Shell Structures and Shell Builders of the 20th Century

Although the art of building domes as special shell structures has been known since ancient times, Melaragno (1991) argued that, “*at the beginning of the last century, under the influence of the art movement and the dominance of industrialized*

building materials, any remnants of curvilinear architecture were mercilessly banished. Within that period avant-garde art emphatically proclaimed a total repudiation of the traditions and classical revivals that in architecture were symbolized mostly by arches and vaults. Ready-to-use rectilinear steel beams and columns and easy-to-build rectilinear concrete forms struck a lethal blow to the curvilinear approach in architecture”.

From this point of view it can be said that arches, vaults, and thin-shelled structures must be rediscovered. After the golden years of shell structures in the 1960s the question of “is there a revival of interest in shell structures in this century, and where might it lead?” can be answered through the development of computational techniques, growth in material availability, cost factors, labor supply, construction techniques etc., all of which play a part and should be examined. The question of how the impact of information technologies and Biomimesis will create new horizons should also be brought up for the next generation of shell designs.

As mentioned in the previous part of the study, in the 20th century a rapid development in reinforced concrete technology was observed. New structural solutions and new forms by master builders were developed, stretching the performance of concrete to its limits. The maximum efficiency of concrete obtained from its fluid property was achieved through the introduction of load-bearing surface structure “shells” in the early 1920s.

Thin shells and other surface structures constitute a type of construction that is drastically different from that of linear structures, whether they are planar or spatial. Thin shells, membranes, slabs, and pneumatic structures, which all come under the heading of surface structures, constitute an enormous field that offers a great variety of solutions to specific problems. Three-dimensional cables and two-dimensional membranes, for instance, correspond to each other in terms of forces, as do arches to shells, and beams to slabs. This correspondence of planar to three-dimensional structures derives from a similitude of structural behavior observable in each individual system. The similar behavior of cables and membranes causes them to change shape under different load conditions. Thus, these two structures are always stressed only by tensile forces.

3.2.4.1 Pioneering Examples

At the beginning of the 20th century the advent of concrete as a new material brought about basic changes in the philosophy of construction, which also affected the construction of shells. Reinforced concrete allowed builders to abandon masonry and employ concrete, mostly in tension, compression, and bending, for a wide range of applications, including building frames. This new field of architecture and structural typology captured the imagination of numerous designers, some of whom emerged as “innovators”.

In this part of the study, starting from the benchmark examples of masonry domes, concrete shells and large steel contemporary domes are presented in historical terms as case studies and in conceptual terms from an architectural and structural point of view. When conducting a literature survey it is seen that masonry domes are covered by texts on architectural history; concrete shell structures are covered in case studies in the architectural press and in scientific engineering press from a structural point of view; and large steel domes are usually described only in engineering periodicals.

When the users of reinforced concrete in the creation of high curvature surfaces are considered the name that comes to the forefront is Antoni Gaudi. Gaudi (1852-1926) pioneered scientific components in architectural design by exploring the potential of geometry. His major contribution, through which he certainly enriched the development of curvilinear architectural forms, was in the creation of new shapes, especially the development of the hyperbolic paraboloid. Whether it is seen as an artistic creation or as a discovery of geometric relationships in the platonic sense, Gaudi's hyperbolic paraboloid is an almost magical shape that will continue to intrigue the mind (Fischer, 1964). This concept explores not only the geometric relationships that generate the form, but also the possibilities of construction methods and the very rationality of structural behavior (Perez, 1979). The Church of the Sagrada Familia in Barcelona, for which he designed the hyperbolic paraboloid, remains as a memorable landmark for those sensitive to architectural pacesetting.

Robert Maillart (1872-1940) can be considered as the first architect to master concrete as a new material in the creation of new forms. He began his career in the early years of reinforced concrete, and in exploring the potential of this moldable, durable mixture, created prototypes. Art and technology became one in many of his structures, and certainly Maillart's contribution to concrete structures has had a tremendous influence on the art of the concrete shell. The Zementhalle for the Swiss Provinces Exhibition, though an isolated sample of Maillart's design, establishes this eminence (Mainstone, 1998). Maillart's name remains associated with innovative concrete forms that extend the structural virtuosity of thin shells.

Another important example, Eugene Freyssinet, was one of the pioneers of concrete shell construction, launching a technique that was perfected by Eduardo Torroja and Felix Candela. Freyssinet is known mostly as an innovator in "thin shell" structures. He contributed significantly to the development of pre-stressed concrete technology by founding inventive techniques for this new methodology in reinforced concrete: lightness. Freyssinet's strong association with thin-shell design is shown in his airship hangar at Orly, France (Muriel, 1994: 260).

A further major contribution was made by Franz Dischinger (1887-1953) in terms of the "construction and implantations" of concrete thin shells. He was part of the original group of German engineers responsible for the great impetus associated with new theories of shell construction in the 1920s in central Europe. In 1922, he was a part of the team that designed the hemispherical dome for the Zeiss optical company (Melaragno, 1991). Up until 1932, Dischinger's work dominated the design and construction of the most prominent shell structures in Germany.

Pier Luigi Nervi (1891-1979) emerged in the 1950s as a versatile personality, bridging architecture and civil engineering. With an important appreciation of the integrity of hybrid structures, Nervi explored the powerful contribution of geometric forms to structural strength, and provided a logical interpretation of how materials must be used. His explorations in geometry were bold and extremely imaginative, yet always contained a strong, disciplined rigor that avoided illogical extravagance. According to Huxtable, the great success of Nervi's structures was derived from his intuitive use of "prefabrication", using a modular type of building component that was

mass-produced and cast on site. He was able to assemble complex structures with great economy (Huxtable, 1965). Nervi often used shells in “combination with other structural elements” to great architectural effect, for example his 5,000-seat Palazzetto dello Sport (Figure 3.15), Olympic grounds, Rome, has a series of Y-shaped columns splayed outward at its perimeter to act like flying buttresses (Zannos, 1987).

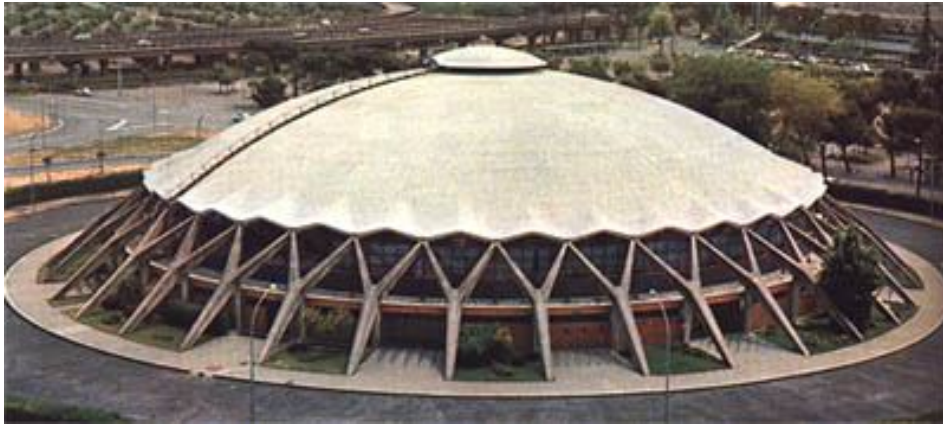

Figure 3.16 The dome of Palazzetto dello Sport, Rome by Nervi (Source: <http://en.structurae.de/photos/index.cfm?js=11138>).

The continuing development of design, analysis, and construction techniques of shell and spatial structures has resulted in an increasing fund of information of practical interest to architects, engineers, and builders throughout the 20th century. The IASS, founded by Eduardo Torroja (1899-1961) in 1959, has as its goal the achievement of further progress through an interchange of ideas among all those interested in lightweight structural systems, such as lattice, tension, membrane, and shell structures. Eduardo Torroja continued the tradition of architectural virtuosity in Spain begun by Antoni Gaudí. According to Harris, Torroja must have been influenced in his architectural thinking by the daring and innovative creativeness in Gaudí's art (Harris, 1991). Like Nervi, Torroja was trained in civil engineering and expanded his knowledge into architectural composition. The material he used mostly was reinforced concrete in the form of thin shells.

Compressive form-active structures were also produced in metal. After World War II another important person, Buckminster Fuller, came into prominence. He transferred technology developed for the war into the building industry and used new materials such as plastics and lightweight metals. The strength to weight ratios of these new materials opened an opportunity to create new forms of buildings and construction systems. He was the great inventor of his time and a pioneer in the use of technology in architecture. Fuller examined maximum performance from a minimum of material. He worked on space frames and geodesic domes that could be mass produced and easily transportable, managing to integrate design and technology with a technical background to form the building's expression.

In the last half of the 20th century, the works of Anton Tedesco (1903-) made a major contribution to the advancement of thin-shell design in the United States. Among his thin shells is that of the new Lambert Field terminal building in St. Louis, built in collaboration with Hellmuth, Yamascale and Leinweber; and in collaboration with I. M. Pei he designed a hyperbolic paraboloid gable-roofed shell in Denver that stands out as an inspiring prototype.

In the early 1950s the name Felix Candela came to dominate in the field of shell architecture, especially in Mexico. Coming from an architectural education rather than an engineering background, Candela uses the geometry of his daring structures as a starting point that evolves through engineering and construction to completion (Candela, 1960). One of the major geometric forms he most uniquely explored is the hyperbolic paraboloid. This complex form lends itself to the most unimaginable architectural compositions, ones that only Candela has thus far been able to create. In addition to his creative uses of solid geometry, Candela used materials and construction techniques in a unique, imaginative way. His structures achieve a thinness that astonishes observers. Candela's structures are refreshingly free of the cold, mechanical qualities that the industrialization of the building art frequently generates. From among his famous works, the Medalla de la Virgen Milagrosa Church, the Los Manantiales Restaurant (Figure 3.16), and the Sports Palace for the XIX Olympic Games can be mentioned.



Figure 3.17 The shell of Los Manantiales Restaurant, Mexico by Candela (Source: <http://www.princeton.edu/main/news/archive/S22/33/11G69>).

Development of curvilinear architecture continued with Eero Saarinen's (1910-1961) powerful prototypes, included different species of curvilinear forms, from convex to concave, from orthodox geometries to unorthodox free forms. Encouraged by the new architecture of the 1950s, which emerged with intense energy after the war, Saarinen was arguably the pioneer of those exploring the possibilities of curvilinearity by using concave shapes for suspended roofs, as well as convex domical shells. From his concave suspended roof over the Dulles Airport terminal in Washington, to the traditional dome he used with a new, modern vocabulary for the M.I.T. Auditorium in Cambridge, Massachusetts, (Figure 3.17), Saarinen has left an indelible mark. Unlike Nervi, and Candela, Saarinen expressed himself in mostly architectural terms, and therefore had more impact in architectural circles, which could have led to his continued achievement. Roman claims that *"...one wonders whether the progress of curvilinear architecture would have been extended beyond its current level if Eero Saarinen had lived longer"* (Roman, 2003). Among his famous works are the Gateway Arch frames at the Old Courthouse, Saint Louis, the TWA Flight Center, New York, (Figure 5.8), and Dulles International Airport, Washington.

In Europe, after World War II, Mircea Mihailescu (1920-) studied shells with a strong background in the analysis of these structures, and his approach to design came from this standpoint. However, he was able to reach the same level of architectural quality as other designers that started from an aesthetic concept of form. Beginning

his career just after World War II, Mihailescu was unfamiliar at the time with the architecture of Felix Candela, but was motivated by the work of the German school of the 1930s. He saw in the thin shell structure the practical expression of an analytical surface containing membrane stresses within its thickness. Major works by Mihailescu include a railway depot in Brasov, Romania (1947), consisting of forty conoidal shell elements, each cast on movable centerings; a textile factory in Bucharest (1958), consisting of a cylindrical roof shell cast on movable centering and a health spa in Olanesti, Romania (1960).



Figure 3.18 TWA Flight Center and Kresge Auditorium, MIT, Cambridge by Saarinen
(Source: <http://www.bluffton.edu/~sullivanm/index/saarinen/saarinenindex.html>).

French architecture in the 1950s was based on the relationship between art and technology. The aesthetic expression of structures was to again gain importance in the post-war years with the rapid erection of industrial and cultural buildings. Jean Prouve designed a wide spanning system of parabolic vaults and attached curtain walls of glass and steel to the Centre National d'Industries et Technologies (CNIT, 1953–58), which was the largest clear span shell structure in the world at the beginning of the 1990s. (Figure 3.18)

To sum up, the recent history of architecture can be seen as a development towards lightness. In the last two decades developments in material and construction technologies have made it possible to design more challenging forms through shells. The shell is the one way of creating the lightness and great flexibility of modern form. Concrete shells developed in the mid-20th century were highly popular among

architects and engineers, being at the cutting edge of structural design. With the invention of the computer in the late-20th century, designers have gained the capability to determine stresses within a structural member much more ease and speed than 10 years earlier. To explore fully the qualities of a material the designer must have a vast knowledge of its properties. This requires an intuitive ability to read a building as a structural object, and to have advanced technical knowledge.



Figure 3.19 the roof of Centre National d'Industries et Technologies by Prouve (Source: Addis, 1994)

3.2.5 Present Techniques in the Analysis of Shell Structures

The analysis and design of shell structures is a topic of interest in a variety of engineering disciplines. The civil engineer is concerned with shell applications in architecture for span roofs and silos. The mechanical engineer is interested in the design of pressure vessels, including nuclear reactor containment vessels and pipes. The aeronautical engineer is involved in the structural design of aircraft, rockets, and aerospace vehicles (Zingoni, 1997). All of these structures require the analysis and design of shells.

Although architects also need an understanding of the analysis and design of shell structures, they may not be able to devote the time to study in detail or become specialized in the mathematical theory of shells. Therefore, the goal of this text is to explain, in a simple and concise manner, some important aspects of shell analysis

and design by understanding shell behavior. The most important aim of this research is to prove that in design practice, when a shell is analyzed using an available computer program, the designer/researcher must have sufficient knowledge of shell behavior to be able to verify the accuracy of the results and interpret them correctly.

According to Billington, the four essential problems facing a designer of revolutionary concrete thin shells, more or less in order of importance, are “construction”, “experimentation”, “analysis”, and “appearance”, through which the best-known pioneers of thin shells became known as builders as well as designers. Designers need to be aware of construction problems and the possibilities of experimental results on digital and scale models, of the limits and techniques for appropriate simplified “analysis”, and finally the visual results of the designer’s choices.

Therefore, this part of the study aims to cover briefly analytical and numerical methods in shell analysis. There is a general theory relating to thin shells, developed by Vlasov, 1951 (Calladine, 1983), to describe shell behavior. This theory consists of elements of stresses and displacements, membrane theory of axisymmetric shell geometry, application of membrane theory to axisymmetric, non-axisymmetric loading, bending theory of cylindrical shells, the effect of ring stiffeners, and bending theory of spherical and conical shells.

Shell structures can usually be analyzed by modeling a set of beams, arches, and catenaries. Shell structures draw their strength from shape and not from the strength of the materials used, and also can carry relatively large point loads. These structures are very complex and carry forces along many paths. For any shell structure, there will be a simple method of analysis that can be used to check the more precise analysis. Stiffest path concepts are useful in understanding shell structures (Ketchum, 1997).

As an architectural application, shells came into the architectural concur with thin-shelled structures, a three-dimensional form made thicker than a membrane so that it can not only resist tension as membranes do, but also compression. On the other

hand, a thin shell is made thinner than a slab, which makes it unable to resist bending as a slab does. In short, thin shells are structures that are thicker than membranes, but thinner than slabs (Calladine, 1983). The theory behind the concept of thin-shelled structure made possible the experimental shell structures in architecture that will be covered in the next part of this chapter.

A thin shell is a curved membrane that is thin enough to develop negligible bending stresses over most of its surface, but thick enough not to buckle under small compressive stresses. A thin shell develops under load membrane stresses, such as tensile, compressive, and tangential shear. A thin shell is stable under any smooth load which does not overstress it, since it does not have to change shape to avoid the development of compressive stresses (Chatterjee, 1988). Thin shells are made out of materials capable of resisting compressive and tensile stresses, such as metals, timber, and plastics. They are ideally suited to reinforced concrete construction because of the ease with which concrete is poured or sprayed into curved shapes.

In order to develop membrane stresses over most of its surface, a thin shell must be properly supported. A proper support is one which:

- develops membrane reactions, i.e. reactions acting in the plane tangent to the shell at the boundary.
- allows membrane displacements at the boundary of the shell, i.e. displacements developed by the strains from membrane stresses.

If the support reactions are not tangential to the shell, or if the membrane displacements are prevented by the support, the shell develops bending stresses, usually near the boundary, which are referred to as bending boundary disturbances. If the shell shape and the support conditions are both chosen incorrectly, the shell may develop bending stresses over its entire surface. A shell designed in such a way cannot act as a thin shell, meaning it does not support most of the load of the membrane stresses.

Figure 3.20 illustrates that the influence of the support conditions on thin shell stresses are given by the behavior of cylindrical barrel shell under its own dead load.

When a long cylindrical barrel is supported at its end on stiff frames, it acts like a beam of semicircular cross section and develops longitudinal stresses (f_x) distributed linearly across its depth, tangential shears ($f_{x\phi}$) and hoop stresses (f_ϕ), which vanish along its longitudinal boundary. The membrane stresses f_x , f_ϕ , and $f_{x\phi}$ are capable of carrying the load without the development of bending stresses and lateral thrust. The same barrel supported along its longitudinal boundaries acts as a series of identical semicircular arches, and since the circle is not the funicular of the dead load, the shell develops a thrust and additionally hoop stresses (f_ϕ), bending stresses (f_b), and transverse shear stresses (f_{sx}) all over its surface. Even if the longitudinally supported barrel has a centenary cross section, which is a funicular for the dead load, it cannot be funicular for another load, and is bound to develop bending stresses under loads such as snow.

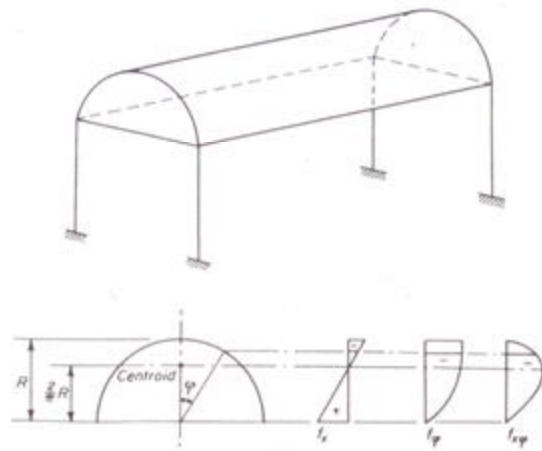

Figure 3.20 Axial and shear forces in the shell element under axial load. (Source: Salvadori, 1982: 324).

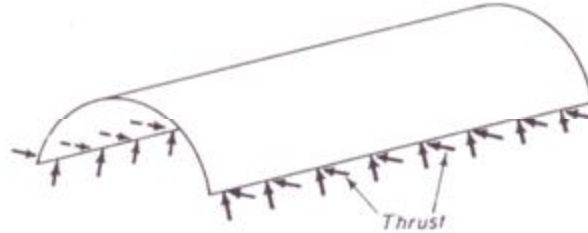

Figure 3.21 Axial and shear forces in the shell element under axial load. (Source: Salvadori, 1982: 324).

It is thus seen that a thin shell will act properly, i.e. will carry most of its load through membrane stresses, only if it is thin, properly shaped, and correctly supported.

In general, membrane stresses are so small that in most cases the thickness of a shell is determined by the bending boundary disturbances. Even so, membrane stresses must be evaluated in order to:

- determine where tensile stresses may develop and provide adequate tensile reinforcement if the shell is made out of an essentially compressive stress and check buckling.
- determine the highest compressive stress and check buckling.
- determine membrane boundary displacements and the bending stresses developed by their partial or total prevention.

According to Billington, materials in standard thin shell theory are assumed to be homogenous, isotropic, and linearly elastic. Concrete is none of these, but numerous experimental results have demonstrated that for working loads the standard theory predicts short-term loading behavior. (Medwadowski, 1971)

3.3 Concluding Remarks of Chapter 3

As it is seen from the classification of architectural structures inspired from nature, the tendency is using nature as a source of "form" and still in the infancy of the real meaning of Biomimesis in architecture. Interestingly, Frei Otto who is one of the innovative architects observing, experimenting and learning from nature and

implementing those ideas to his designs naming this process as “form finding process” and given the title to his book “Finding Form”.

All these structures namely, tree-like, web-like, skeleton-like, pneumatics and shell-like structures can be investigated for the discussions of nature-architecture relationship and potentials of Biomimesis for next generation structures which requires minimum amount of material and energy for maximum efficiency to avoid excesses and overbuilding.

This process can be considered as “multi-dimensionality in the natural world”. In this process every organism in nature avoids excesses and “overbuilding”, gains maximum efficiency with minimum material and energy, recycles and finds a use for everything, requires local expertise, runs on the sun and other natural sources of energy, and uses only the energy and resources that it needs.

CHAPTER 4

MATERIALS AND METHODOLOGY

In this chapter, the materials and methods used to carry out this study are presented. For this interdisciplinary research, first of all a literature survey was conducted on the subject of “Biomimesis” to discuss how researchers in various disciplines are learning of various design concepts from nature. Afterwards, the questions of “what is Biomimesis in architecture” in the light of examples from past and present; and “what should be Biomimesis in architecture” for the next generation of designs, are discussed. After noting the differences in inspiration levels and learning approaches in architecture and other disciplines, the missing element was found to be the lack of methodology to be used. In the light of the literature survey, it was noted that a systematic approach with objective parameters should have been developed to understand the potential of biomimesis in architecture. To exemplify the research question, it was decided to concentrate on “shell” forms, which are common in both nature and architecture. Shells in architecture, in which form, function, and structure take shape simultaneously, were examined according to the era in which they were constructed.

For this research it was important to focus and set relationships among rules of mathematics/generation, form, function, structural behavior, and material properties of a particular natural object to understand the potentials of Biomimesis in architecture. It is believed that to parameterize those properties and understand the relationships among them would help designers, as an “initial wise guess”, to create new optimized forms/structures in architecture. In organisms of complex forms in nature this intent may be difficult to recognize. However, seashells are one of the complex forms whose functions, in form and structure, are simple enough to be approximated through mathematical relationships. Therefore, among the shell structures in nature, the coiled seashell geometry, called Turitella Terebra, was selected due to their manageable complex form, which has been an interesting model for man-made structures and has been used as a strong form in art and architecture throughout history. As is evident in existing man-made structures, one

structural system, known as the shell structure, expresses the concept of structural forms similar to those of seashell forms in nature.

The research undertaken by the author in this study focused on this problem, and the following materials and methods are presented.

4.1 Materials

The materials used for this study can be listed as follows:

- i. A literature survey into the research domain, conducted at the libraries of Middle East Technical University, Bilkent University, and the Istanbul Technical University in Turkey, and in the University of Bath in the UK, the thesis library of YÖK¹¹, the online library of UMI digital dissertations, online papers and published material obtained from the internet.
- ii. A survey into the relationship between nature and architecture. A classification of structures found in nature that have influenced architectural structures.
- iii. Studies into natural and man-made shells, a literature survey on the origins and pioneering examples of man-made shells.
- iv. A brief biological study of seashells.
- v. Documentation and analysis of 150 Turitella Terebra seashell specimens from the muddy sands of the tropical region of the Indo-Pacific, obtained from Miami, USA.
- vi. After the cutting, scanning, and measurement of selected seashells, a mathematical study of shell geometry.
- vii. A survey on the mathematical properties of seashells and their applications in architecture
- viii. A program, using the parameters of a scanned seashell, written in C++, to reconstruct the Turitella Terebra¹². A survey into the material

¹¹ The Council of Higher Education of the Republic of Turkey.

¹² Carried out in collaboration with Dr. Chris Williams and Alex Fisher, Department of Architecture and Civil Engineering, University of Bath, UK.

properties of different types of seashells and biomimetic studies on seashell materials.

- ix. Structural behavior tests on randomly selected cut seashells. Compression tests with an AGS-JShimadzu 10kN-type machine¹³.
- x. Finite Element Analysis Software (SAP2000)¹⁴ to repeat and compare the analysis on actual seashells.
- xi. Statistical data, obtained from mechanical tests of sample space and FEM tests, to yield comparisons and analogical possibilities of man-made

4.2 Methodology

In the field of architecture, there are several designs created by imitating/modeling or drawing inspiration from forms in nature. It cannot be denied that most of the end products of those imitation processes have become milestones in the history of architecture due to their innovative form, structure, and construction techniques, resulting in developments in many fields through the pioneering of many new and successful designs. However, these successes have not gone beyond the visual challenge of an architectural form.

The implementations of the concept of Biomimesis in the field of architecture are mostly observed in the design of forms/shapes. However, in this study, besides those forms/shapes in nature, structural behavior and the optimized response to internal and external loads of these forms, together with their geometrical configurations, are studied to provide a systematic for the design by nature and a methodology for innovative structure design in architecture.

The study followed the following procedure:

- i- A literature survey was conducted in order to define the research problem and to gain information about Biomimesis, Biomimesis in architecture, and

¹³ Located in the Mechanical Laboratory of the Department of Metallurgical and Materials Engineering, METU. Tests conducted with Dr. Caner Durucan and Gül Çevik, METE, METU. The specimens were prepared and cut with a high speed cutter at the Material Laboratory of the Department of Architecture, METU.

¹⁴ Software supplied by the Department of Architecture, METU.

the optimization process of man-made products, highly concentrated on architectural shell forms and structures

- ii- Focus on man-made shells and natural seashells to enable comparison.
- iii- Mathematical analyses on a number of selected and cut seashells to reveal their generation rules and mathematical properties.
- iv- Research conducted at the University of Bath, UK, from June to September 2005. The research included a literature survey into the subject and guidelines of Turitella Terebra; development of reconstruction software at the University of Bath, UK. Writing of Turitella Terebra reconstruction software in C++, taking data from the measurements of an actual seashell. This method is superior to those of previous researchers, who roughly abstracted seashell forms.
- v- Documentation of a sample set of 150 seashells by taking photographs and measuring the height, weight, whorl number, and base ratio properties of each specimen. Afterwards, randomly selected shells were prepared for mechanical tests and were re-documented.
- vi- The testing of 86 specimens using a 10 kN SHIMADZU AGS-J-type Strain-Extension Controller static machine to analyze compressive properties. The data from this process is obtained through a program written in TRAPEZUM-2 software, and all the data plotted in Microsoft Office EXCEL, 2003.

CHAPTER 5

CASE STUDY: (RE)DISCOVERING (SEA)SHELL ARCHITECTURE

The question of to what extent the limitations/borders of architecture have expanded and the potential new horizons for the next generation of architecture can be answered through an analysis of the changing design paradigms; the development in designs, computation, and manufacturing tools; and the amount of available data, information, and diverse processing methods. Together with the above, a potential expansion of this discussion may be the concept of “Biomimesis in architecture”, an approach to learn from the best ideas in nature for further innovations in architecture. As explained in detail in previous chapters, many other disciplines have raised such questions from the point of view of their particular field of interest, and Biomimesis has been accepted as one of the new approaches for the changing requirements of the new world.

One the most challenging sections of this study was to develop a system that could help understand the large quantity of data coming from different disciplines, such as biology, mathematics, and engineering, and transfer them to architecture. For this reason a thinking cycle was accepted as a road map, which is a common method in many disciplines: **observe** the real problem, **collect data** and evaluate it to create a **working model**, simplify the large quantity of data with a **mathematical model** based on known mathematical theories, and improve that working model to obtain a **computational model** that can compute the data and evaluate the results for feedback.

This thinking cycle of the new era seems appropriate to understand the complex forms and structures of nature, and then to explore the potential of Biomimesis in architecture. In the next step, to explore the potentials of biomimesis in architecture, shells and then seashells are selected for the reasons explained in Chapter 3 and a methodology is proposed to exemplify the argument of this thesis. The developed methodology starts with an **observation** of seashells and their interpretations in art and architecture. Then, the **data collected** from the selected and analyzed seashells is **evaluated** in a logical way to create a **mathematical model** of the **real**

problem. This large quantity of data is simplified using non-dimensional parameters to obtain a **working model**. This working model is improved to obtain a **computational model**, which will compute the structural properties of the selected seashell and evaluate the results for feedback.

In this chapter a systematic/an algorithm that should be followed in the analysis of natural forms is presented on the example of seashells. For the purpose of how the proposed method will be carried out is illustrated through this diagram (Figure 5.1). Detailed explanation of each decision/ flow chart step will be explained in the sections given below.

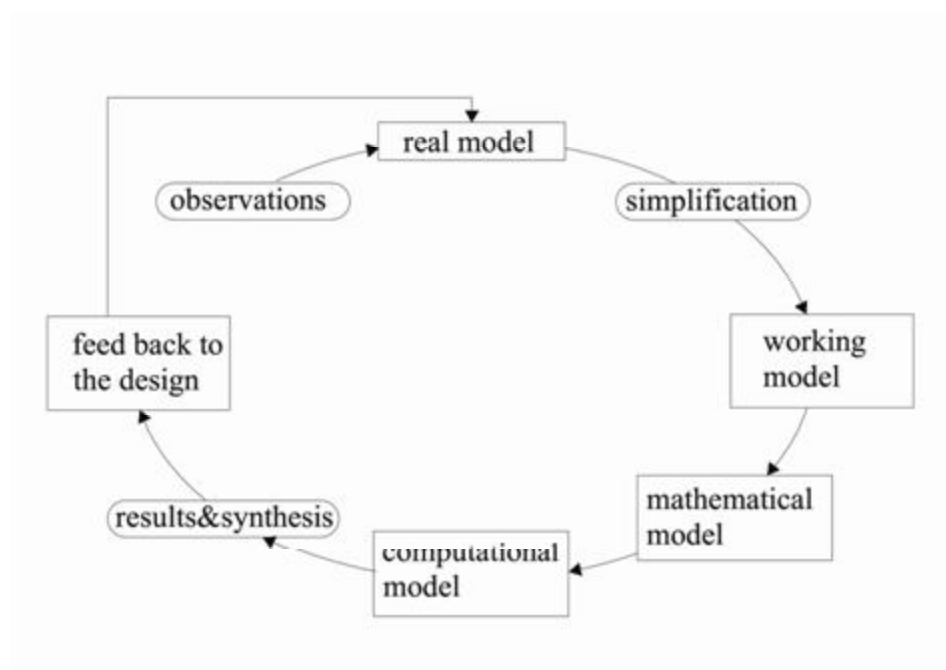

Figure 5.1 Simplified computation cycle for learning from nature¹⁵

5.1 Observation of Shell Forms Inspired from Nature

In nature, most shells are rigid dwellings made up of dead tissue, having form, geometry, and a supporting structure in which living creatures dwell. In this sense,

¹⁵ Graphics drawn based on the discussions with Dr. Arzu GÖNENÇ SORGUÇ

shells in nature are “architecture”. According to Hersey (1999) the word “shell” is frequently architectural, stating that “*many languages have these sayings and other analogies; for example Conca, “shell” in Italian, also means “nich” in that language; coquille, “shell” in French also means “house”; and, in German, “snail shell” is Schneckenhaus*” (Hersey,1999: 42).

It was found in the literature survey that shells are among the most common and most efficient structural elements in nature. Possibly for this reason, examples of shells in the morphology of nature are particularly abundant. Seashells, egg shells, turtles, skulls, nuts, and the nests of some birds and insects can be included in this category. Many artists have been inspired by the beauty, diversity, and form of shells, and hence convey them into their masterpieces. Similarly, throughout history, some of the plan types, façade elements, and ornamentations in architecture have been profoundly influenced by the geometry of these forms of snails, clams, scallops, and other marine mollusks. Furthermore, many scientists have also studied shell forms from mathematical and geometrical points of view, in addition to their material properties, for further studies.

It is believed that rapid developments in material and construction technologies and increasing computational power will allow further implementations of man-made shells, having high structural stabilities and the capacity to bridge larger spans with minimum material, energy consumption, and sheltering characteristics, as can be found in nature. Shell structures have the potential to be explored for new and innovative designs in architecture, moreover seashells, which are accepted as a demonstration of “multidimensional natural processes for the formation of structures” will contribute to our present level of knowledge within the realm of Biomimesis.

In this context, this chapter is focused on “seashells”, to link the shells found in nature to the shell forms in architecture through such aspects as form to geometry, and structure to function. Starting from the ancient examples of these inspirations, representative examples of seashells in art and architecture are summarized.

5.1.1 Interpretations of Different Seashell Forms and Spirals in Art and Architecture throughout History

Throughout the ages, seashells have been an object of inspiration and have held a prominent place in many cultures. The oldest known examples of the seashell in art are found in the cave paintings of France and Belgium, says Senosiain, who adds that the Americans, Mayas, Toltecs, Aztecs, and Incas used shells as symbols, tools, musical instruments, money, ornaments and jewellery. In the archaeological digs at many ancient sites, many remains of shell forms, such as ornaments, have been found (Senosiain, 2003). Phoenicians, Greeks, and Romans used the shell shape as part of their building design and decoration (Hersey, 1999:43), and similar examples have been found in Anatolia and Africa. Renaissance Europe embraced endless architectural shapes enriched with decorative elements associated with these creatures (Senosiain, 2003: 53).

It can also be seen that seashells have long been a subject of interest in the paintings of artists. For example, "The Birth of Venus" by Botticelli (1484) was created according to classic mythology, in which a girl appears on a seashell symbolizing being born from the sea. As the story goes, the delicate droplets of water that rolled gently down her body fell into the shell, creating beautifully formed pearls¹⁶ (Figure 5.2). During the Rococo style of the 18th century, the seashell appeared in diverse arts, carefully and fancifully wrought with great imagination. During the period of Flemish Baroque, Rembrandt painted molluscs with great precision, beauty and naturalness (Cook, 1979). Miro and Picasso created paintings in which seashells were the main subject. Henry Moore sculpted pieces with shapes that announced the prolific presence of molluscs¹⁷. Again, it is obvious that Leonardo da Vinci was aware of the aesthetics found in seashells, namely Ammonites (Figure 5.3).

¹⁶ WebMuseum Paris The Birth of Venus <http://www.marbledassics.com/artist-botticelli-birth-venus-art.htm>

¹⁷ Molluscan Art, Architecture and Art Forms http://www.manandmollusc.net/links_art.html
last accessed on Nov 2005



Figure 5.2 The Birth of Venus, Sandro Botticelli, (Source: <http://www.ibiblio.org/wm/paint/auth/botticelli/venus/venus.jpg>).



Figure 5.3 Seashell abstractions by Leonardo da Vinci (Source: Cook, 1979:363).

Inspiration from seashells has continued into paintings from modern times, such as studies by Dimitri Mytara¹⁸, Uriy Kakichev¹⁹, and Mogilevsky Konstantin²⁰. (Figure 5.4)

¹⁸ <http://www.aegeanshells.gr/painting.htm>

¹⁹ <http://www.paintingofrussia.com/>

²⁰ <http://www.artgallery.com.ua/bigpicture.php?Artist=1&ID=011&lng=eng>



Figure 5.4 Seashells in modern painting (Source: <http://www.artgallery.com.ua/bigpicture.php?Artist=1&ID=011&lng=eng>)

From an architectural point of view, the balance between form and structure synthesized in the mollusk's shell represents a stimulating challenge for architects. For practical reasons its characteristics have been adopted as principles for building; as in the compressed vault and the curved structure, a prevailing element in Roman, Byzantine, Romanesque, Gothic and Renaissance architecture (Senosiain, 2003, 50). Moreover, in the history of architecture, the ages of the Baroque and Rococo can be considered as the beginning of seashell interpretations in architecture. Those years coincide with the first systematic studies in mollusk classification by Georges Cuvier in 1799 (Thompson, 1992; 177).

Studies into the "spirals" found in shells were also a source of inspiration for architects. So common were Archimedian and Equiangular spirals in architecture that these forms can be seen in Ionic, Corinthian, and composite capitals from ancient Greece and from Rome, throughout the Middle Ages, and into modern times (Cook, 1979). (Figure 5.5)



Figure 5.5 Seashells and columns (Source: Hersey, 1999)

Similarly, seashells have inspired many architects in the design of stairs in their buildings. According to Cook, who devoted chapters of his book to spiral stairs, “*Saint-Etienne-du- Mont, Paris, the two right handed helical staircases are perhaps France’s most flamboyant architectural spirals*”. Steeply wrapping their columellas, and of symmetrically reflective handedness, they circle upward to a horizontal bridge across the church’s nave (Figure 5.6). It is clear that, these shapes in seashells fascinated also Leonardo da Vinci while designing his double helix staircases in the form of a double snail (Figure 5.5). This kind of seashell-like staircase was common in multi-storey buildings where stairs were needed throughout the medieval and early Renaissance architecture (Cook, 1979).

According to Hersey (1999) the word “shell” is frequently architectural, stating that “*many languages have these sayings and other analogies; for example Conca, “shell” in Italian, also means “niche” in that language; coquille, “shell” in French also means “house”; and, in German, “snail shell” is Schneckenhaus*” (Figure 5.7). When the last century’s architecture is considered, Gaudi incorporated the spiral line into his columns, stairs and towers. Le Corbusier designed a museum with a spiral shape and continuous growth. Bruce Goff defined the structure of Bavinger House with a long stone wall forming an ascending logarithmic spiral (Cook, 1979).



Figure 5.6 Spirals and staircases (Source: Hersey, 1999)



Figure 5.7 Examples from seashells in architecture (Source: Hersey, 1999; 53-56)

Certainly the most well-known architectural design-based seashell inspiration is the Guggenheim Museum by Frank Lloyd Wright. The building rises as a warm beige spiral and its interior is similar to the inside of a seashell. The architect spent a great deal of time studying molluscs, and designed a continuous living space in harmony with structure and form; one style, one color and just one material (Figure 5.8). Wright expresses his thoughts on seashell architecture as follows: *"...the dwellings of these primarily lives of the sea are the houses we lack; it would be like living in a beautiful and naturally inspired way. Observe the innate capacity for invention revealed in this collection of minute residences built by hundreds of small, natural*

creatures. Each one has built its own house with a lovely, unmistakable variation that will never end..." (Heinz, 2000)



Figure 5.8 Inner and outer spaces of Guggenheim Museum by Frank Lloyd Wright (Source: Senosiain, 2003)

Kenzo Tange built Olympic Games Stadium in Tokyo by drawing inspiration from the seashell structure. In its interior the primeval form of the tent takes on a fantastic new dimension, and its exterior has the dynamic tension of a seashell.

Another important example is the famous Opera House in Sydney, designed by John Utzon. Giedion²¹ explains that *"..the architect solved the vaulting problem by use of a sequence of ten great shells, rising up to sixty meters over the Opera House. The folding wings of each of these giant shells (erected without use of scaffolding) tilt over a single section of the complex, each closed by a concave glass wall designed to be spatially sucked up into the vault"*. Sydney author Ruth Park wrote about the Sydney Opera House in 1973: *"..to walk into the Opera House is to walk inside a sculpture, or perhaps a seashell, maybe an intricate, half-translucent nautilus. Morphology and the computers have composed a world of strange breathless shapes, vast, individual, quite unlike any other architecture I have ever*

21 Sigfried Giedion, *Architecture of the 1960's: Hopes and Fears*
<http://www.arch.columbia.edu/Projects/Courses/Image.schemata/giedion.html>

seen...²². Although these shells are unsuccessful in many aspects, such as in construction and economy, the importance of those shells may be based on the involvement one of the “earliest uses of computers in structural analysis” in order to understand the complex forces the shells would be subject to (Jones, 2006).



Figure 5.9 Shells of Sydney Opera by John Utzon (Source: Senosiain, 2003)

The Community of Christ temple was designed by Gyo Obata (HOK), Missouri (1994), and evokes the spiral shell of the *Turritella Terebra*, with a stainless steel spire that raises nearly 90 meters (Chiat, 2004, 72). To create this extraordinary shape architects wrote a computer program to produce the spiral, and then refined the shape (Figure 5.10). The aim of using such a complex spiral as a metaphor was probably to raise the sky like a heavenly object, and to create a feeling of eternity inside the space. Again in this example the spiral form executes the architectural meaning and function.



Figure 5.10 Inner and outer spaces of Community of Christ by HOK (Source: Chiat, 2004)



Figure 5.11 Sage Gateshead cultural center by Foster (Source: www.fosterandpartners.com)

Foster and Partners designed a performing arts centre, the Sage Gateshead, in the UK. The building is created with a cross-section that resembles the geometry of a seashell, and was developed using specialized parametric modeling software. The complex toroid geometry of the enclosure was rationalized to allow a repetition and standardization of the construction elements (Figure 5.11).

There have also been a number of researchers that have studied seashells and their spiral forms to facilitate the form finding processes in architecture. For example, Jirapong discovered several architectural forms using mathematics that “modeled”

seashell geometry. He asserts that the qualities of these types of architectural spaces are very convenient to human nature from a psychological point of view (Figure 5.12).

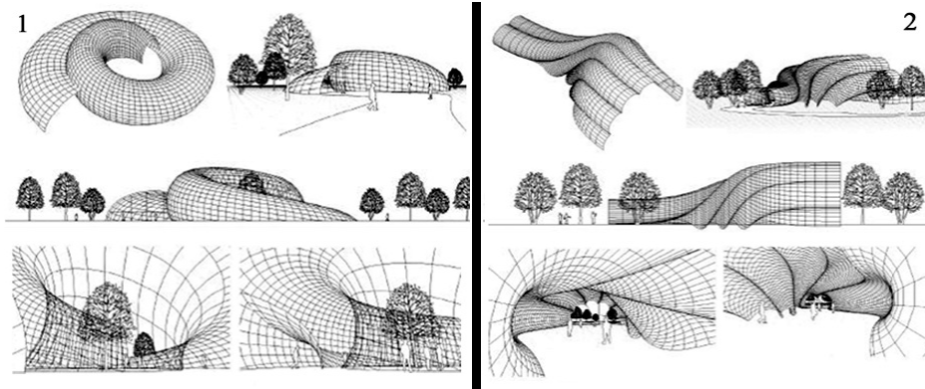

Figure 5.12 Experimental shell architecture by Jirapong (Source: Jirapong, 2002)

The applications and researches in contemporary architecture which are inspired from seashell geometry and spirals, or from the spatial properties of these structures may be greatly expanded. However it is believed that the mentioned examples, starting from the early periods of architectural history, are the best examples of how architects have been inspired by the forms of seashells and spirals in nature. In addition, it is worthwhile mentioning these end products, as they have already been recognized as among the best buildings of their era. Furthermore, it is possible to find clues from these examples to answer the question of how the next generation of shells will be designed.

5.2 Analysis of Seashells and Seashell Geometry

In many made structures, structural behavior of a shell is derived directly from its form, thus when designing a shell-like structure, the fundamental consideration is the choice of geometry. This not only dictates the esthetics, but also the overall efficiency and behavior under load of the structural system.

As can be seen from the examples, the seashell form has an important impact on architectural form. The geometric structural and spatial features of seashells have influenced architecture throughout history. It is believed that the analysis of a seashell's morphology and an understanding of their geometrical properties will provide designers when it is examined in a systematic way while designing a shell structure resembling those in nature.

Actually, the seashell exhibits various interesting properties, from its material properties to its structural efficiency, from pattern to color. All these properties are interrelated to the shape of the seashell. For further investigation of seashell geometry, a general knowledge about the biological properties of seashells is required (Related documents are available in Appendix 1), and an understanding of their mathematical properties. In this regard, approaches to the mathematical study of seashells will be reviewed from related literature in the following section. Finally, the mathematical properties of the selected seashell, namely Turitella Terebra, will be examined. For this research, it is important to reveal how the complex geometry of a seashell, which affects its overall shape and structure, can be simplified/abstracted, and explained through the use of mathematical rules to develop a mathematical model, and then a computational model of seashells.

5.2.1 Mathematical Studies on Seashell Geometry

Historically, mathematicians have come up with methods for describing curved and fractal geometry in nature, such as the logarithmic spiral of the mollusk shell, the closest packing arrangement of bees, and the branching structures of wing membranes and trees. Mathematical ratios have been used to represent and predict the harmony, consistency, and proportion of that plants, animals and physical matter show in growth and movement.

In coiled seashells, growth generally takes place at the rim of the aperture, which expands as the shell grows while the overall shape of the shell remains the same. Based on this knowledge, one can theoretically trace back each point on the rim

through successive earlier growth stages to the apex, which is the oldest part of the shell (Figure 5.13). Normally gastropod shell forms consist of a conical tube that forms a coiled structure of one or more revolutions of whorls (Moore, 2001). Early naturalists recognized that this shell curve is similar to the form of a particular kind of spiral, known as the logarithmic or equiangular spiral (Thompson, 2001).

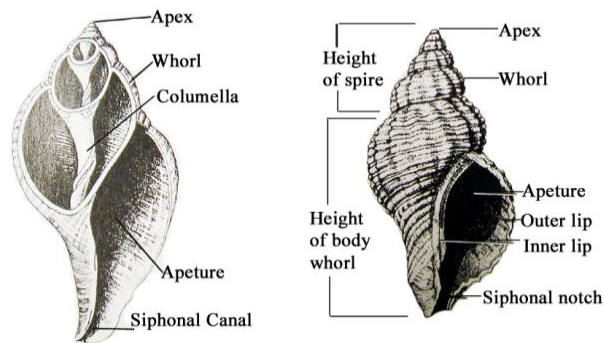

Figure 5.13 Shell parts (Source: Brusca, 2002:722)

The logarithmic spiral can be used to understand the generation model of seashells. It is a mathematical curve which has the unique property of maintaining a constant angle between the radius and the tangent to the curve at any point on the curve. It is also known as an equiangular spiral and can be illustrated using the polar coordinate system (Figure 5.14). The position of a point on the curve is determined by two values; r , which is the distance from the point to the origin of the coordinate system; and θ , which is the angle between a radius and the horizontal line to the right of the origin. The general equation of the logarithmic spiral is (Seggem, 1990):

$$r = ae^{\theta \cot \alpha} \quad (1)$$

where a is a constant radial distance from the origin of the coordinate system to the beginning of the spiral; α is the constant angle between the radius and a tangent to

the curve; and e is the base of the natural logarithmic ($e=2.72$). In the logarithmic spiral of the coiled shells the whorl continually increases in breadth at a constant ratio. Each ratio is broader than its predecessor in a definite ratio when measuring in the same angle of radius.

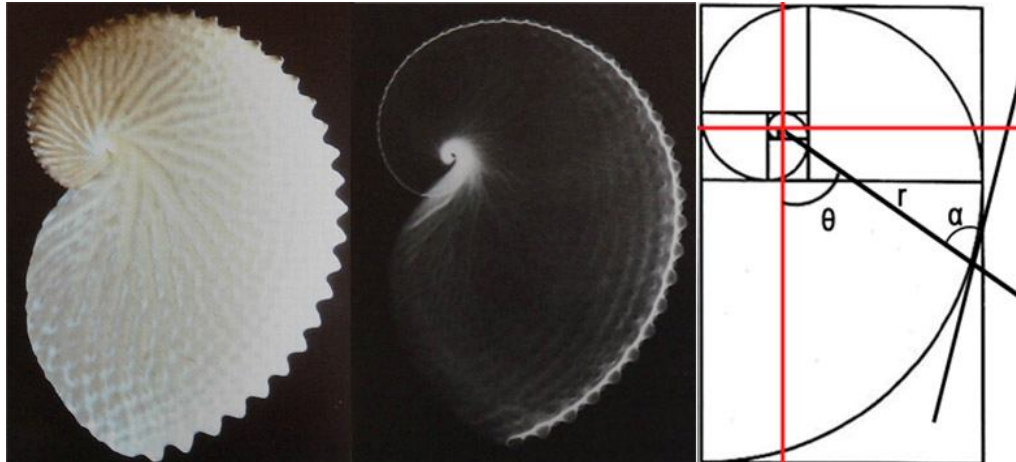

Figure 5.14 X-Ray view of a shell (Source: Conklin, 1985) and its logarithmic spiral (Gyorgy, 1981)

5.2.2 Modeling Approaches on Seashell Geometry

The first attempt to define a spiral mathematically was the logarithmic spiral by Descartes in 1638 (Meinhardt, 2003). Since then, several studies have been carried out in several disciplines, such as mathematics, biology, and paleontology, to understand and decipher the relations of these complex forms. Starting with Moseley (1838) many investigators have focused on the curves of the seashell and their mathematical properties. He was followed by many researchers, such as Thompson (1942), Raup (1961, 1962, 1965, 1969), Kawaguchi (1982), Cortie (1989), Illert (1983, 1987, 1989, 1995), Dawkins (1996), and Fowler (1998) (Meinhardt, 2003), among others, who outlined a number mathematical relations that control the overall geometry of seashells. In their studies and models, the logarithmic spiral was used to model the natural growth and self-similarity encountered in these forms

The theoretical seashell morphology can be traced back to the work of Moseley, who derived equations for calculating the volume, surface area, and center of gravity of planispiral and trochospiral shells. Thomson presented some measurements of a wide variety of taxonomic and functional shell types and showed their conformity with the logarithmic spiral (Thompson, 1992). (Figure 5.15)

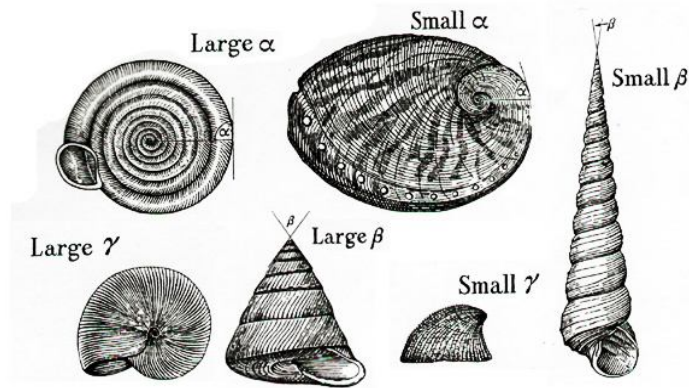

Figure 5.15 Seashell modeling parameters by Thompson (Thompson, 1992:192)

Another important study that parameterizes the growth of seashells was realized by Raup, who is known as the pioneer of computer modeling of shell morphology with the application of displaying shell shapes using a computer. In his first paper on this topic he introduced dimensional plots of longitudinal cross-sections of shells as a blueprint for manually drawing shell forms (Raup, 1961). He then extended his model to three dimensions (Raup, 1965) and visualized shell models as stereo pairs to emphasize the three-dimensional construction of the shells (Raup, 1969). His models were plotted as a collection of dots and lines.

Raup described the geometry of seashells using three parameters, which he called **whorl** (rate of expansion of the generating curve), **distance** (relative distance between the generating curve and axis of coiling), and **translation** (the change of the cone's movement along an axis with respect to the whorl). The working strategy of the Raup method can be summarized as: the spiral rotates around a fixed axis,

which always remains geometrically similar to itself. Then, to create the shape of the seashell, a generating curve rotates around the spiral, increasing its size as it spirals down. Finally, any dimension of any seashell can be found by one of three parameters. Due to his parametric approach, Raup's model is still accepted as one of the most effective seashell models in literature.

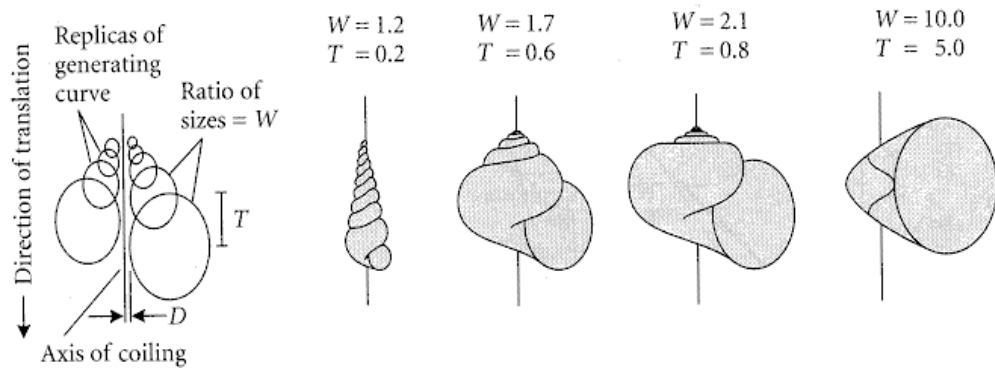

Figure 5.16 The parameters controls shell geometry (Source: Raup, 1965).

Figure 5.16 by Raup illustrates the effect on the overall shell geometry for changes in these different parameters, using an ellipse as the whorl cross-section. However, it is clear from observations of actual shells (Figure 5.21) that the cross-section is more complex than the input that the three parameters allow. In the pursuit of realistic visualizations, Kawaguchi enhanced the appearance of shell models using filled polygons which represented the surface of shells more convincingly than line drawings. Similar techniques were used subsequently by Oppenheimer (1986) and Prusinkiewicz and Strebel (1986). A different approach was adopted by Pickover (1989) who approximated shell surfaces by using interpenetrating spheres. Illert (1989) introduced Frenet Frames (Bronsvort, 1985) to precisely orient the opening of a shell. His model also captured a form of surface sculpture. Cortie (1989) studied the pattern forms on the surface of the shell model. Finally, the model of seashell geometry by Fowler et al. (2003) was similar to that introduced by Raup, and was the first to implement free-form cross sections using a Bézier curve (Farin, 2002; Rogers, 2001) as the input. All the above studies focused on modeling the appearance of the shell surface.

After examining all these approaches, it is seen that each can be considered as a milestone for their era, as each model reflects the observation and tools of measurement, modeling and technologies of the time. Thus, in all these approaches seashells were modeled as a single surface, as a two-dimensional object, and embedded in three-dimensional space. Today, such modeling research should be carried out employing observation tools, knowledge, information, and computational technologies to the maximum extent. For this reason, in this research a mathematical model is developed that can be transformed into a computational model for further studies.

As it is mentioned, available seashell models were constructed according to some abstractions and assumptions within the range of information researchers have. In this research much work has been done to accurately model the cross-section of the shell, showing the thickness of the shell wall and the complex solid volumes that are formed down the internal spine. As described above, shells as a structural mechanism are incredibly sensitive to variations in geometry. These models were not sufficient to understand how varying curvilinear affects the overall strength of the seashell, and it was therefore essential for this research to create a method for generating a computational model for seashells that included the actual generating curve and thickness of the seashell, thus providing a model which can form the basis for a three-dimensional structural analysis. The following section explains the mathematical and the computational modeling process of the selected seashell.

5.3 Computational Model Developed for the Coiled Seashells

The surface of any shell may be generated by the revolution about a fixed axis of a closed curve, which, remaining always geometrically similar to itself, increases its dimensions continually. [...] Let us imagine some characteristic point within this closed curve, such as its centre of gravity. Starting from a fixed origin, this characteristic point describes an equiangular spiral in space about a fixed axis (namely the axis of the shell), with or without a simultaneous movement of translation along the axis. The scale of the figure increases in geometrical progression while the angle of rotation increases in

arithmetical, and the centre of similitude remains fixed. [...] The form of the generating curve is seldom open to easy mathematical expressions (Thompson, 1992 Chapter VI).

The first studies were into the concept of 3D spirals, the so-called “helix” in Cartesian coordinate and polar coordinate systems. (Figure 5.17) According to Chris Williams, the natural description of shell shapes may be given in terms of a generating spiral and the shape of the opening, generating curve or section. Firstly, a simple computer program was written that incorporated a simple function describing the geometry of a seashell. The parameters of the program were similar to the Raup’s model (Figure 5.17).

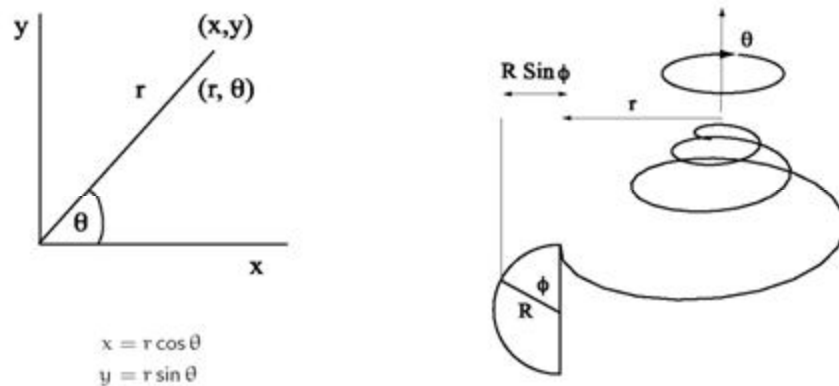

Figure 5.17 3D spiral in Cartesian coordinate and polar coordinate systems

The proposed parameters of the program are:

S: Section; Shape of the aperture or shape of the shell's tube cross section

H: Horizontal Displacement; Departure from the coiling axis of the section in the horizontal direction

V: Vertical Displacement; Translation along the vertical direction of the coiling axis

G: Growth: Aperture expansion or the rate of increase of section size

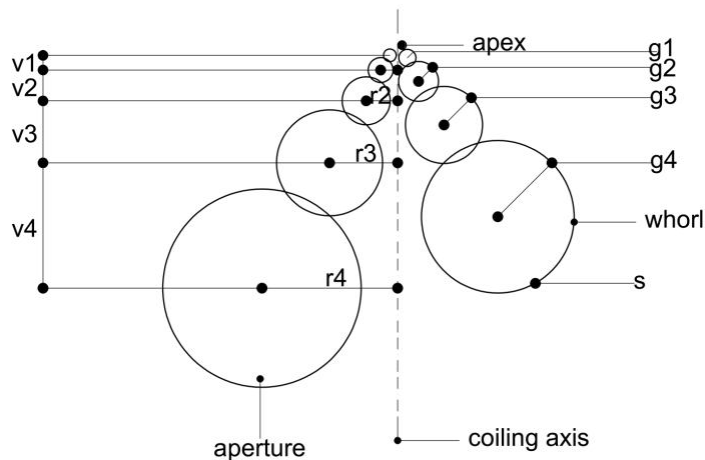

Figure 5.18 Proposed seashell parameters

The generating curve, section is accepted as a circle, and the growth path as a logarithmic spiral (Figure 5.19). The results with changing parameters are shown in Figure 5.19 and Figure 5.20 in a wire frame view, generated by rotating the circles along the axis of the spiral. The end product of the program is a drawing file (dxf) comprising 3D surfaces which can be fed into all CAD and CAM software. The number of surfaces can be controlled to obtain a more or less smooth logarithmic surface.

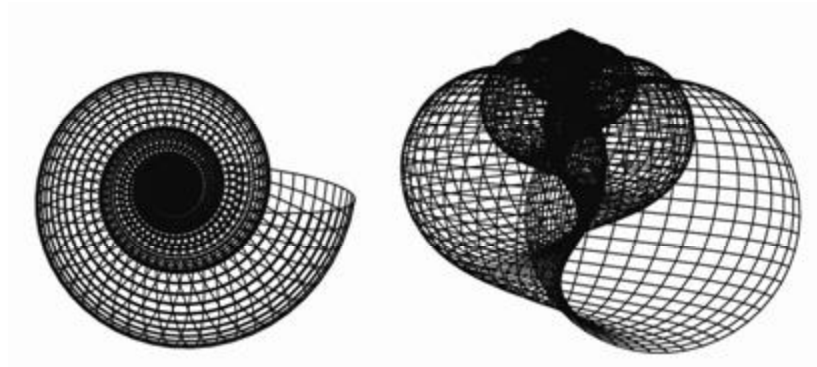

Figure 5.19 Abstracted seashell models developed by the author

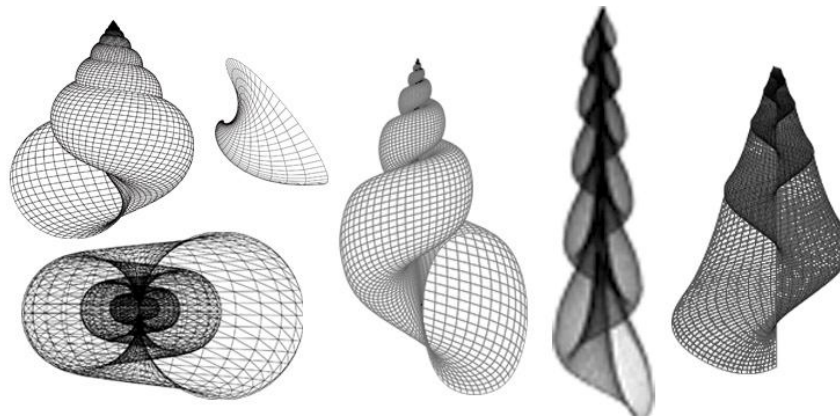

Figure 5.20 Abstracted seashell models developed by the author

This simple program was not sufficient to model the selected seashell of this research. As mentioned before, the generating curve of the seashells has a more complex geometry than the circular abstractions. For this reason a wide research is conducted on the geometry of the *Turitella Terebra* to understand the actual form and structure of the shell (Arslan Selçuk, 2006). The first stage is an analysis of the mathematical properties of that particular seashell, followed by the design of an algorithm to create its mathematical model.

5.3.1. Mathematical Analysis of the Selected Seashell: Turritella Terebra

All coiled seashells are formed in nature by growth at the shell's free leading edge and a surface of revolution formed along a spiral path about the shell's axis. Their increase in overall size is achieved purely from the successive addition of material to one end only. From an inspection of actual seashell cross-sections, the older previously-formed parts of the shell remain, on the whole, unaffected and geometrically unchanged once produced (Arslan Selçuk et al, 2005) (Figure 5.20). The surface of the shell is determined by a generating curve, in section, sweeping along the above helico-spiral. The generating curve is of constant shape, but increases in size by a constant ratio as the section sweeps the curve. The size of the section increases as it revolves around the shell axis. The shape of section determines the profile of the whorls and of the shell opening. The impact of section on the shape of a shell is shown in Figure 5.21.



Figure 5.21 Cut cross-sections of a selection of seashells found in nature (was being cut in the Ceramic Laboratory of Department of METE, METU)

For this reason, an understanding of the geometrical model of *Turitella Terebra* begins with the analysis of the “section”. A number of samples were cut vertically with a high speed cutter at the Material Laboratory in the Department of Architecture, METU. A set of numerical data was obtained from the cut shells. As seen from Figure 5.22, the shell grows with some constant coefficients. To clarify this coefficient some dimensional parameters were listed, such as height, base diameter, number of coils, distance/displacement between each generating curve in the vertical and in horizontal, as in Table 5.1, to enable understanding of the numerical relations of the shell. These parameters were entered into the program, thus modeling the *Turitella Terebra*.

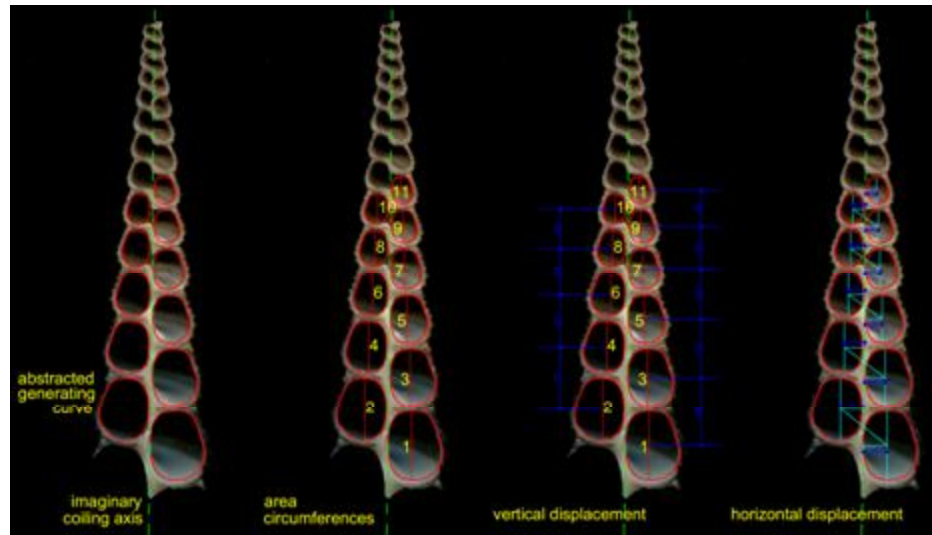

Figure 5.22 Geometrical analysis of the vertical section of *Turitella Terebra*

As seen from the Table 5.1, there is an always constant coefficient which defines the growth of seashell. For *Turitella Terebra* these coefficients are; 1.20 for the area of each sequential whorl, 1.10 for the circumferences of each sequential whorl, 1.16 for the vertical displacement, and finally, 1.16 for the horizontal displacement of whorl.

Table 5.1 Coefficients found in the vertical section of Turitella Terebra

	area	k	Circumference	k	vertical displacement	horizontal displacement		
whorl01	4943	1.20	254	1.09	88	1.15	30	1.15
whorl02	4108	1.21	231	1.10	74	1.17	26	1.18
whorl03	3385	1.22	210	1.10	63	1.16	22	1.16
whorl04	2764	1.19	190	1.09	54	1.17	19	1.18
whorl05	2321	1.19	174	1.09	46		16	1.15
whorl06	1948	1.21	159	1.10			14	
whorl07	1596	1.20	144	1.09	79	1.17		
whorl08	1320	1.20	131	1.10	67	1.15		
whorl09	1093	1.20	119	1.10	58	1.16		
whorl10	905	1.20	108	1.09	50			
whorl11	749		99					

5.3.2 Mathematical Model of Turitella Terebra

Previous studies into seashell modeling have set out parametric rules to define the abstracted shell form; however the approaches of the researchers failed to generate forms that exactly replicated the seashell in nature. In particular, the section parameter brought forward by Raup was not sufficient to model the species in the natural world, and that was why Fowler designed his model according to a cross section, which would generate the closest shape of the seashell by logarithmic spiral. However, his model was also not adequate to model the seashell selected for this research, which is looking for the form-structure relationship.

For this reason it became a requirement to write an algorithm to create a mathematical model that takes its parameters from a real cut Turitella Terebra. A parametric model of the shell was set up using the cross section of a single whorl as the input. In a similar approach to Fowler et al, (Fowler, 1992) the shape of a single typical whorl was defined as a B-spline, which can be used to approximate a smooth

curve from a small set of control points (Farin, 2002-Rogers, 2001). Figure 5.23 shows a B-spline of order five, and its control polygon.

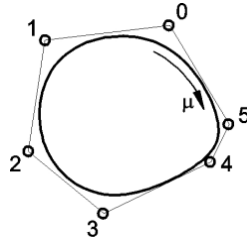

Figure 5.23 A typical B-spline and its control polygon

The surface of the shell is determined from a section created with a B-spline, sweeping along the above helico-spiral. The section takes its parameters from the whorl of the cut shell. Therefore, the main approach in modeling the solid cross-section of the Turitella Terebra was to first generate the internal whorl surface, which forms the cavity in which the gastropod lives. A portion of this surface could then be offset defining the outermost surface and the thickness of the shell (Figure 5.24). The volume between these two surfaces would then form the geometry of the solid material which forms the shell.

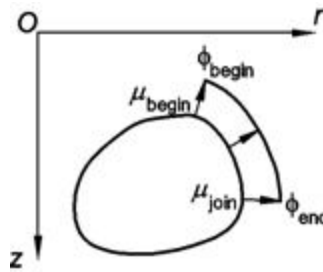

Figure 5.24 The outermost surface of the shell

From the definition of a B-spline the curve is parameterized along its length, with respect to parameter μ with a range of $0 \leq \mu \leq 1.0$. $\mu = 0$ and 1.0 refer to the start and end of the closed loop respectively, whilst the point $\mu = 0.5$ is half way around the length of the curve. Between the values $\mu_{begin} = 0$ and μ_{join} the whorl B-spline is

offset by a given thickness to form the outer surface of the shell. This was the first assumption for the model that shells cross section has a constant thickness. The outer surface is parameterized between ϕ_{begin} and ϕ_{end} . A single whorl cross-section in its local coordinate system is illustrated in Figure 5.23 and Figure 5.24. The ribs on the external shell surface, as illustrated later in Figure 5.29, is generated by superimposing a sine-based function onto the surface normal component of the position vectors. This was the second assumption to define wave function on the surface of *Turitella Terebra*.

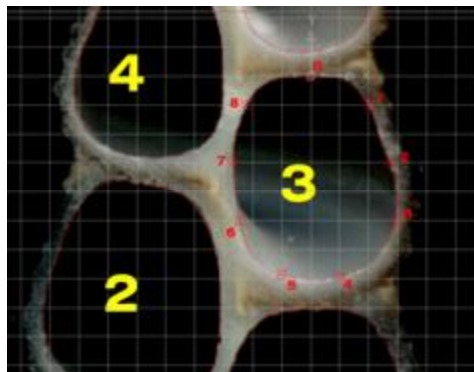

Figure 5.25 The points controlling of generating curve from scanned cut shell

The shell surface geometry is defined using cylindrical polar coordinates (r, θ, z) , which can be expressed in terms of Cartesian coordinates (x, y, z) :

$$\begin{aligned} x &= r \cos \theta \\ y &= r \sin \theta \\ z &= z \end{aligned} \tag{1}$$

Similar to the models of other researchers, the modeling of a shell surface starts with the construction of a logarithmic helicon spiral (H) (Coxeter, 1961). It has the parametric description of:

$$\Theta = t, r = r_0 \xi^t, z = z_0 \xi_z^t \tag{2}$$

The path along which a shell's whorl cross-section follows is a logarithmic spiral, and it is the geometric properties of this curve that define the overall geometry of the shell. A logarithmic spiral is a curve which forms a constant angle between its tangent and radius vector at any point. Hence, logarithmic spirals have the alternative name of equiangular spirals. Figure 5.26 illustrates the constant λ , which defines the rate of spiral for any such curve.

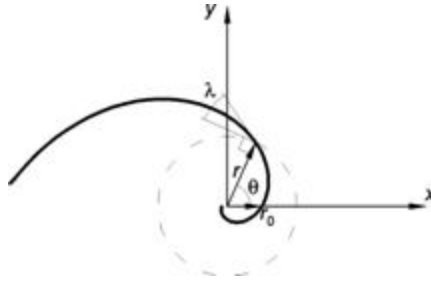

Figure 5.26 Geometry of the logarithmic spiral.

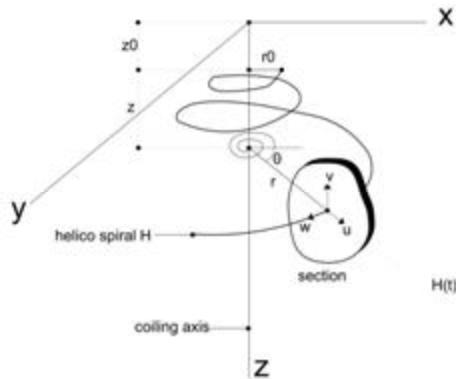

Figure 5.27 Construction of the shell surface

The relationship between any two points on a logarithmic spiral can be described by the formula below:

$$\tan \lambda = \frac{1}{r} \frac{dr}{d\theta} \quad (3)$$

giving

$$e^{\theta \tan \lambda} = \frac{r}{r_0} \quad (4)$$

where r_0 is the radius at $\theta = 0$.

From observations made of real seashells, the growth rings, which correspond to the whorl cross-section, are not radial and do not even lie in one plane, but are rather curves in three dimensions. This means that the shell's rate of spiral, λ , as previously illustrated, is required to be such that the point ϕ_{begin} on the current leading edge cross-section must lie coincident with ϕ_{end} on the preceding section after slightly less than one revolution about the major z-axis, i.e. $\Delta\theta = 2\pi - \theta_{join}$, as illustrated in Figure 8 and expressed in the following equation (5):

$$r(\theta, \phi_{end}) = r(\theta + 2\pi - \theta_{join}, \phi_{begin}) \quad (5)$$

Thus λ is controlled by the relationship:

$$e^{(2\pi - \theta_{join}) \tan \lambda} = \frac{r_1}{r_0} \quad (6)$$

where:

λ = rate of spiral constant

r_0 = radius to point ϕ_0

r_1 = radius to point ϕ'_0

$\theta_{join} = \theta_{shift}$ at point ϕ_{join}

The growth constant is applied to the whorl by transforming its coordinates using the formulae below, based on the cylindrical polar coordinate transformation (equation (1)):

$$\begin{aligned}
 x &= e^{\theta \tan \lambda} r \cos \theta \\
 y &= e^{\theta \tan \lambda} r \sin \theta \\
 z &= e^{\theta \tan \lambda} z
 \end{aligned}
 \tag{7}$$

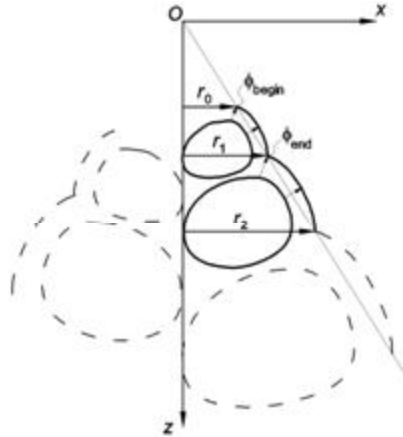

Figure 5.28 Geometric relations of the shell surface

Figure 5.28 illustrates the sequential increase in size of the cross-section, starting from an infinitesimal size at the origin. The shape of the whorl, the value of ϕ_{end} , and the offset thickness are all parameters easily measured from actual seashell cross-sections, and it is from these inputs that the whole three-dimensional shell geometry can be generated. Figure 5.29 and Figure 5.30 shows a well defined correlation between the real natural seashell on the left and the computer generated model on the right. While designing the modeling process of *Turitella Terebra*, it was important to answer three questions: firstly, the question of “precision” of a model was important while reconstructing a natural object. It is believed that precision will affect the results when analyzing the structural behavior of the selected natural structure. This problem is achieved with the section formed by B-Splines. Secondly, computational cost is considered related to the precision of the model. A moderate number of 3D surface elements are used for the mathematical model. Thirdly, the compatibility of the model for finite element analysis of that particular structure was important. It is believed that all these concerns were satisfied with this model. Finally it is important to highlight that the generated algorithm above is flexible to explore different type of coiled shells by changing the parameters shown in Figure 5.18 and Figure 5.25.

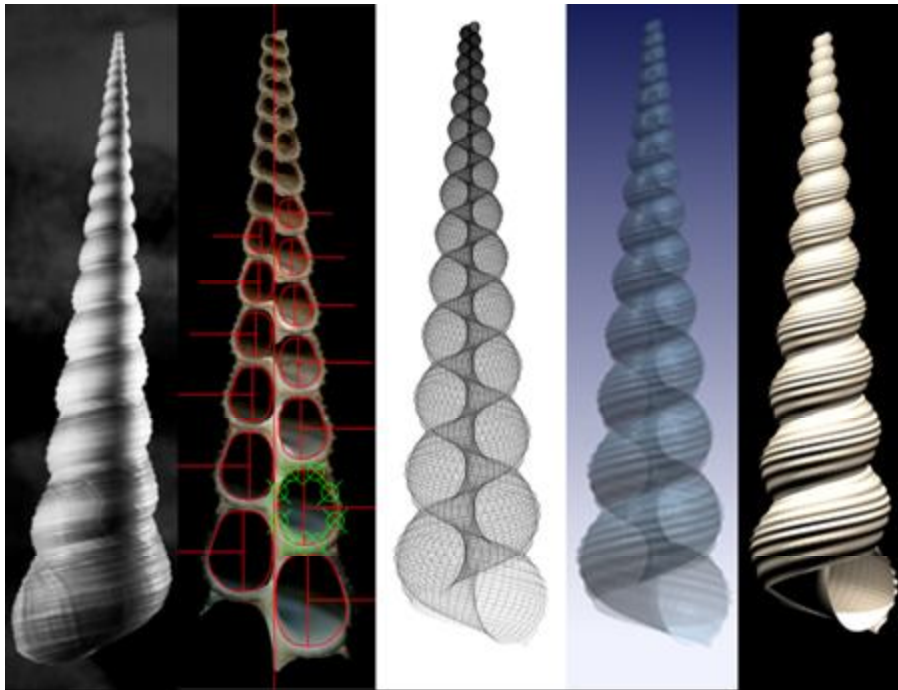

Figure 5.29 S can of the seashell found in nature (left) computer generated shell model (right) by the algorithm developed for this research.

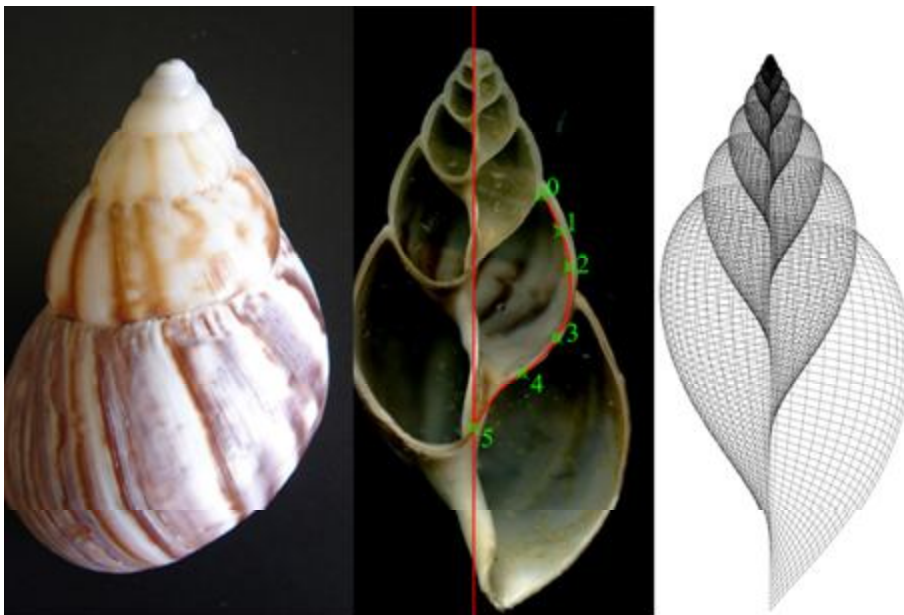

Figure 5.30 Demonstration of the flexibility of the program to experience different coiled seashell forms.

The generated program/algorithm can be explained briefly as a pseudo code;

1. Open splinedata.txt file and read the parameters for the inner B-spline;

- read control points gathered from the cut shell,
- read u-begin, u-join and offset data
- read vertical displacement (k)
- read horizontal displacement (theta)
- read number of whorls (m/n)

2. Calculate closed internal B-spline

```
function=exp(theta*tanlambda);
xValue=function*(xCurve[j][0]*cos(-theta+xCurve[j][2]));
yValue=function*(xCurve[j][0]*sin(-theta+xCurve[j][2]));
zValue=-function*xCurve[j][1];
```

```
xCurve[j][0] = scaled r value for a generating curve
xCurve[j][1] = scaled z value for a generating curve
xCurve[j][2] = scaled theta value for a generating curve
```

3. Calculate the offset between internal closed B-spline and external open B-spline according to u-join and offset value

```
if(j==1)offset=2*offset;
if(j>1) scale (offset)
```

4. calculate the growth constant from

$$\tan \lambda = \frac{1}{r} \frac{dr}{d\theta}$$

which describes the relation between “ Θ ” and any “r” (theta is the angle of the logarithmic spiral and r is the radius of the logarithmic spiral)

5. generate inner surface

```
for(i=0;i<=m;i++)
{
    theta=(2.0*i*PI)/(1.0*n);
    for(j=0;j<=n;j++)
    {
        phi=(2.0*j*PI)/(1.0*n);
//generate inner surface values

        x[i][j]=xValue;
        y[i][j]=yValue;
        z[i][j]=zValue;
```

6. Draw inner surfaces to shell. dxf file

```
void DrawDXFSurface(void)
{
    Turitella <<"0\n3DFACE\n8\n"<<Layer<<"\n";
```

```

Turitella <<"10\n"<<x[i][j]<<"\n";
Turitella <<"20\n"<<y[i][j]<<"\n";
Turitella <<"30\n"<<z[i][j]<<"\n";
Turitella <<"11\n"<<x[i][j+1]<<"\n";
Turitella <<"21\n"<<y[i][j+1]<<"\n";
Turitella <<"31\n"<<z[i][j+1]<<"\n";
Turitella <<"12\n"<<x[i+1][j+1]<<"\n";
Turitella <<"22\n"<<y[i+1][j+1]<<"\n";
Turitella <<"32\n"<<z[i+1][j+1]<<"\n";
Turitella <<"13\n"<<x[i+1][j]<<"\n";
Turitella <<"23\n"<<y[i+1][j]<<"\n";
Turitella <<"33\n"<<z[i+1][j]<<"\n";
Turitella <<"62\n"<<2<<"\n";

```

7. **calculate the external open B-spline and add the sine wave component norm special to Turitella Terebra**

```

for(i=0;i<=m;i++)
{
    theta=(2.0*i*PI)/(1.0*n);
    for(j=0;j<=n;j++)
    {
        phi=(2.0*j*PI)/(1.0*n);
//generate outer surface values
        x[i][j]=xValue;
        y[i][j]=yValue;
        z[i][j]=zValue;
    }
}

```

8. **Draw outer surfaces to shell. dxf file void DrawDXFSurface(void)**

```

{
Turitella<<"0\n3DFACE\n8\n"<<Layer<<"\n";
Turitella <<"10\n"<<x[i][j]<<"\n";
Turitella <<"20\n"<<y[i][j]<<"\n";
Turitella <<"30\n"<<z[i][j]<<"\n";
Turitella <<"11\n"<<x[i][j+1]<<"\n";
Turitella <<"21\n"<<y[i][j+1]<<"\n";
Turitella <<"31\n"<<z[i][j+1]<<"\n";
Turitella <<"12\n"<<x[i+1][j+1]<<"\n";
Turitella <<"22\n"<<y[i+1][j+1]<<"\n";
Turitella <<"32\n"<<z[i+1][j+1]<<"\n";
Turitella <<"13\n"<<x[i+1][j]<<"\n";
Turitella <<"23\n"<<y[i+1][j]<<"\n";
Turitella <<"33\n"<<z[i+1][j]<<"\n";
Turitella <<"62\n"<<2<<"\n";
}

```

9. **Write successful termination message :**
cout<<"\nDXF file written, end of program\n"

10. **Terminate the program**

5.4 Behavioral Analysis of Seashell(s)

In the world, both natural and man-made objects express themselves with their specific forms, all of which have to withstand the forces to which they are exposed. The consistency that confers this capability is the structural capability inherent in its form. To withstand those forces, the internal mechanical action that operates inside each structural form is activated. According to Mainstone (2001), understanding the basic concept of this process, called the “flow of forces”, is a major achievement for the economy of the structural forms (Mainstone, 2001).

The flow of forces does not present problems, since the object form and structure follows the direction of the acting forces. However, when the flow of forces and the structural form are not acting together, the structure collapses. This normally occurs in man-made structures in which the form is delineated in order to serve a particular function and is frequently contrary to the natural flow of forces. Both natural and man-made structures affect a redirection of oncoming forces to preserve a definite form that stands in a definite relation to the function. Both types of structures execute this relation identically on the basis of the two principles: flow of forces and state of equilibrium (Thompson, 1992).

From this viewpoint, forms and structures in nature are examples for learning about the harmony of functions, forms, structures, and materials. As stated previously, a coiling seashell, in this case *Turitella Terebra*, has been selected for the investigation of these properties of natural structures. The seashell has been an interesting natural model for man-made structures throughout architectural history. As is evident in existing man-made structures, one structural system, known as a shell structure, expresses the concept of structural forms similar to the seashell forms in nature. This system is well defined and has been discussed in many classifications of man-made structural systems.

This section of the study investigates the structural behavior of the selected seashells' geometry to understand the relationships between height, base ratio, whorl numbers, and the load they resist. For the analysis of a complex structure, there are two methods commonly implemented among engineers and researchers: physical structural model analysis and digital structural model analysis. In this study **both** methods are used. Firstly, compression tests of 86 selected specimens from 150 Turitella Terebra are carried out, and then the same tests are applied in the digital environment on the digital models of the Turitella Terebra, as explained in the previous part.

There are some limitations governing the structural analysis of a seashell in this research due to factors associated with the form and the structure of the seashell, as most of the equipment in mechanical laboratories and the analysis approaches programmed in FEA software are designed to accommodate conventional orthographic forms i.e. columns and beams. Hence, 86 seashells and their digital models undergo preparation for these tests.

5.4.1 Analytic and Numerical Properties of Turitella Terebra According to Basic Shell Theories

There are several definitions and theories explaining shells and shell behavior, as covered in Chapter 3. According to Vlasov's widely accepted theory Turitella Terebra is "**a thin shell**", being that the thickness of the shell is "thin" with respect to the thickness of other elements in the shell, and that it is a curved surface, thin enough to develop negligible bending stresses over most of its surface, while being thick enough not to buckle under small compressive stresses.

Among the many interesting aspects of the shell in technology, engineering, and architecture, one stands out as being of utmost importance: the shell form is shaped according to the loads that it is exposed to (Zannos, 1987). From this respect one of the most important shell definitions, considering the overall structural behaviors of implementations in architecture, was brought by Heino Engel (1997), who classifies

the existing man-made structural systems into five main categories: form-active, vector-active, section-active, surface-active, and height-active. In this sense, similar to other seashells, the Turitella Terebra has a **form-active** behavior with respect to its geometrical properties; but can also be conceived as a **surface-active** structural system according to its load bearing behavior. Furthermore, after close observations of vertically cut shells it can be claimed that this type of coiling shell is a **section-active** structure due to the overall strength arising from the shape of the generating curve.

Melaragno (1991) classified man made shells as, barrel shells, spherical domes, conoidal shells, cantilevered shells, and hyperbolic paraboloid [hyper]. The form of the Turitella Terebra can be assumed/ perceived as a conic shell when the form is interested. If the form generation is important then the mathematical analysis shows that Turitella Terebra actually manifests hyperbolic paraboloid behavior. When the whole shell and its coiling parts are analyzed in detail it is seen that different parts of the shell have different characteristics. For example, the apex of the shell can be considered as a cantilevered shell and from the surface spanned per whorl, as a barrel shell.

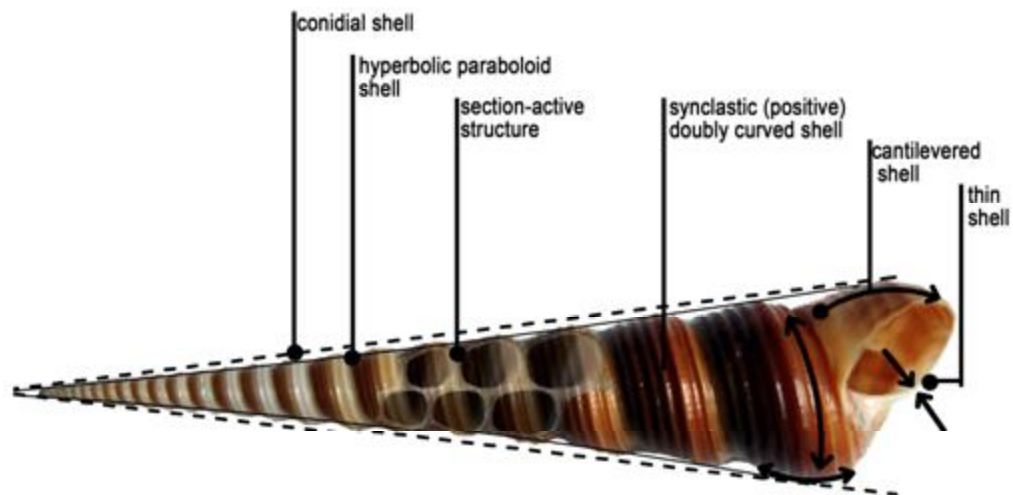

Figure 5.31 Structural analysis of Turitella Terebra according to shell theories.

Generally, shell structures can be divided into two main classifications: singly curved, in which the curvature is in only one direction, and doubly curved, in which the curvature is in both directions. **Turitella Terebra is a synclastic (positive) doubly curved** shell because the curvature of surfaces is concave in both directions. All these analyses from different shell theories are shown in Figure 5.31.

Another classification can be made according to the material properties of shell structures. Thin shell theory is assumed to be homogenous, isotropic, and linearly elastic regarding concrete materials in standard. Mollusc shells are made primarily of calcium carbonate, with traces of strontium and other elements (Kim, 1999). Calcium carbonate is similar to concrete, as numerous experiments have demonstrated, in that for working loads the standard theory predicts short-term loading behavior (Medwadowski, 1971). Therefore Turitella Terebra can be assumed as homogenous and isotropic for the analysis.

5.4.2 Physical Compression Tests on Turitella Terebra

The shell behavior of Turitella Terebra was studied under the compressive loads which are commonly seen in the man made structures. Tests were carried on 150 Turitella Terebra samples, ordered from Miami, USA. Shells were given an ID number randomly from 1 to 150. Then, the total height, base radius, and the number of whorls of each shell were measured using a digital micrometer caliper. The reason why mentioned parameters are selected to measure is that man made shells are also designing according to similar parameters in terms of strength of the shell.

Samples were prepared for testing according to the standards decided after discussions with engineers from the Department of Metallurgical and Materials Engineering, METU. It was decided to submit the shells to compression tests after a cutting process to obtain samples due to their unconventional form.



Figure 5.32 A sample space of 150 Turitella Terebra bought from Cyber Island Shops, Inc, Miami, USA.



Figure 5.33 Measurements with a digital compass.

Table 5.2 Base, height and whorl numbers of each specimen

ID	Base-r	Height	Whorl	ID	Base-r	Height	Whorl	ID	Base-r	Height	Whorl
1	27	127	23	51	30	130	24	101	31	130	19
2	28	123	22	52	30	133	24	102	31	130	20
3	28	127	25	53	30	126	19	103	31	131	24
4	28	120	20	54	30	126	25	104	31	131	23
5	28	126	24	55	30	127	22	105	31	131	23
6	28	126	23	56	30	127	22	106	31	132	22
7	28	127	26	57	30	128	23	107	31	132	23
8	29	128	22	58	30	123	20	108	31	132	22
9	29	127	24	59	30	124	20	109	31	133	22
10	29	127	24	60	30	124	21	110	31	135	24
11	29	128	24	61	30	124	19	111	31	133	23
12	29	128	24	62	30	128	23	112	31	137	25
13	29	131	26	63	30	131	24	113	31	137	22
14	29	131	25	64	30	126	20	114	31	139	25
15	29	131	23	65	30	126	20	115	31	139	28
16	29	131	23	66	30	127	21	116	31	139	25
17	29	132	28	67	30	126	23	117	31	142	25
18	29	132	26	68	30	125	19	118	31	142	25
19	29	110	13	69	30	128	23	119	32	117	16
20	29	119	17	70	30	130	28	120	32	133	12
21	29	119	19	71	30	133	24	121	32	118	14
22	29	121	16	72	30	130	23	122	32	127	23
23	29	121	18	73	30	135	24	123	32	125	13
24	29	123	19	74	30	135	25	124	32	128	24
25	29	123	19	75	30	135	26	125	32	128	20
26	29	124	22	76	30	136	26	126	32	128	24
27	29	124	23	77	30	138	30	127	32	129	22
28	29	125	24	78	31	119	17	128	32	131	22
29	29	128	24	79	31	120	21	129	32	133	25
30	29	127	25	80	31	120	16	130	32	133	25
31	29	128	23	81	31	125	19	131	32	134	21
32	29	129	25	82	31	125	23	132	32	134	22
33	29	129	25	83	31	126	24	133	32	135	25
34	29	133	23	84	31	126	19	134	32	135	25
35	29	133	24	85	31	126	21	135	32	137	22
36	29	133	25	86	31	126	24	136	33	126	21
37	30	139	25	87	31	126	21	137	33	132	20
38	30	115	17	88	31	127	25	138	33	133	20
39	30	117	17	89	31	127	23	139	33	133	22
40	30	113	14	90	31	128	22	140	33	133	20
41	30	126	23	91	31	128	20	141	33	139	18
42	30	128	22	92	31	128	20	142	34	142	20
43	30	124	22	93	31	128	23	143	33	140	24
44	30	125	22	94	31	128	21	144	34	150	20
45	30	122	17	95	31	129	21	145	34	142	21
46	30	124	20	96	31	129	25	146	30	127	22
47	30	126	20	97	31	129	21	147	34	142	22
48	30	127	23	98	31	130	22	148	34	140	22
49	30	132	22	99	31	130	23	149	34	124	21
50	30	132	25	100	31	130	21	150	33	140	21

5.4.2.1 Preparation of Samples for Compression Tests

Since the shells are very complex it was not easy to apply compressive forces in their native forms so specimens were prepared making them suitable for the measurements. For this purpose, specimens were cut to obtain a tapered geometry having parallel surfaces to each other so that uniform compressive loads could be applied. A high speed cutter in the Material Laboratory of the Department of Architecture, METU²³ was used to cut the samples. Prepared samples were re-documented by measurement of height, weight, whorl number, and photographs. Then cut seashells were exposed to compression tests to understand the overall behavior. A total of 86 specimens were tested using a 10 kN SHIMADZU AGS-J-type Strain-Extension Controller static machine to analyze the compressive properties at the Mechanical Laboratory of Department of Metallurgical and Materials Engineering, METU²⁴. The resulting data from this process was obtained through a program written (0.5 mm stroke per second) on TRAPEZUM-2 software, and then all the data was plotted in Microsoft Office EXCEL, 2003. This machine is also able to measure tension and bending limits, however the geometry of a seashell does not lend itself to such tests, and hence was disregarded.

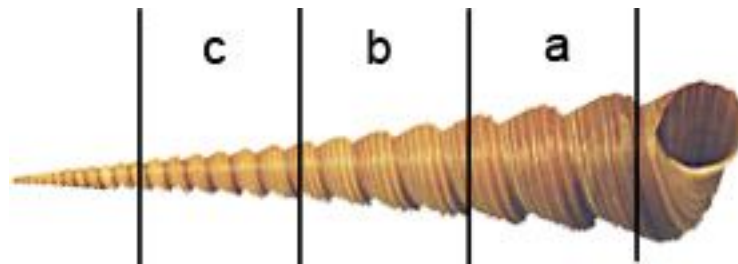

Figure 5.34 Typical cut lines of a Turitella Terebra

²³ The author acknowledges the valuable guidance of Prof. Dr. Emine Caner Saltık and Göze Akoğlu from Mechanical Laboratory of Department of Architecture, METU, who organized the laboratory part of this study

²⁴ The author acknowledges the valuable guidance of Dr. Caner Durucan and Gül Çevik, from Department of Metallurgical and Materials Engineering, METU, who organized the laboratory part of this study

During the cutting process the parts are identified according to the cut lines shown in Figure 5.34 and then each sample was named as the original ID number plus part number.



Figure 5.35 Figure representing a-b-c parts of cut shells

The sample prepared for testing were tabulated according to base radius (mm), height (mm), weight (gr), whorl number, time for failure (sec), structural load for failure (N) and displacement (mm). All these procedure was standardized for documenting each specimen. Pictures from Figure 5.35 to Figure 5.42 show the state of the specimens before testing, after fracture happened, and finally the results of failure on load/time graphics drawn in an EXCEL sheet. The results of tests were plotted in terms of force versus failure

Tests results can be seen in Figure 5.37 Figure 5.40 Figure 5.43. Force failure graphics exhibit typical characteristic of brittle materials that elastic range continues towards to peak of the graphic and than failure starts. The peaks on the graphs show the allowable force to be applied to the shell and after that non linear behavior stars. It is seen that maximum stress appears on the top part of the surface on which forces applied. Then it s transferred to the ground trough the rigid spine on the center of the shell. Spine behaves like a stiffener in man made shell.

Sample 1 - ID109

Table 5.3 Dimensions and test results of sample ID 109

ID number	BASE-R (mm)	HEIGHT (mm)	WEIGHT (gr)	WHORL number	STROKE		
					TIME (sec)	LOAD (N)	(mm)
109-a	27	38	16.03	2.5	64.25	963	0.56
109-b	18	31	4.97	3.5	41.05	1018	0.37



Figure 5.36 S sample ID109 cut shell



Figure 5.37 S sample ID109 tested shell

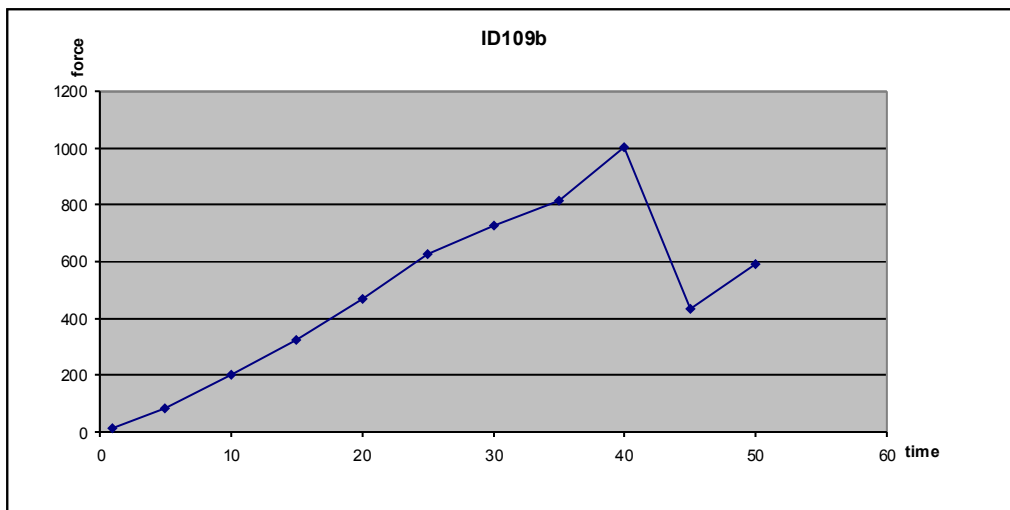
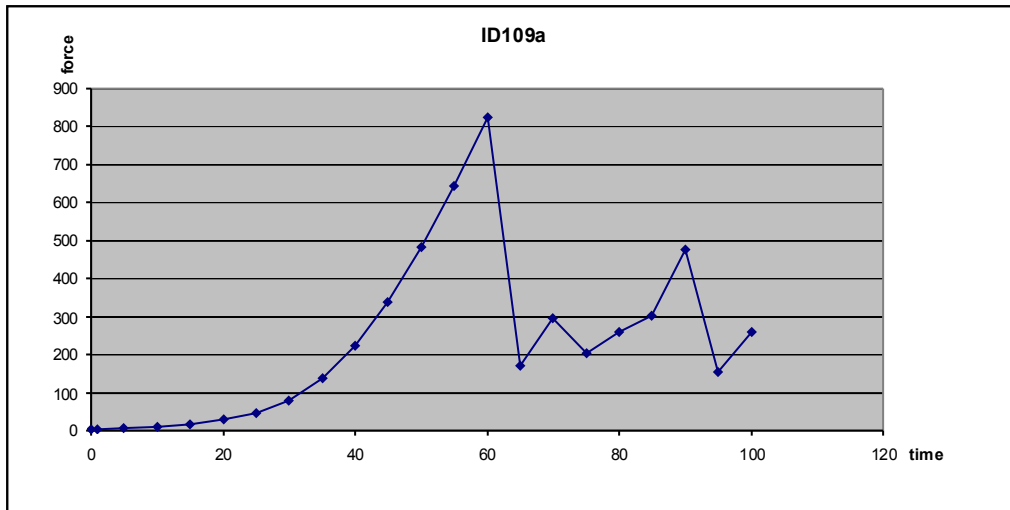

Figure 5.38 Failure graphics of sample ID109a and ID 109b

Sample2- ID140

Table 5.4 Dimensions and test results of sample ID40

ID number	BASE-R (mm)	HEIGHT (mm)	WEIGHT (gr)	WHORL number	TIME (sec)	LOAD (N)	STROKE (mm)
140-a	30	36	13.42	2	48.15	429	0.43
140-b	18	29	3.91	3	71.55	472	0.62



Figure 5.39 S ample ID140 cut shell



Figure 5.40 S ample ID140 tested shell

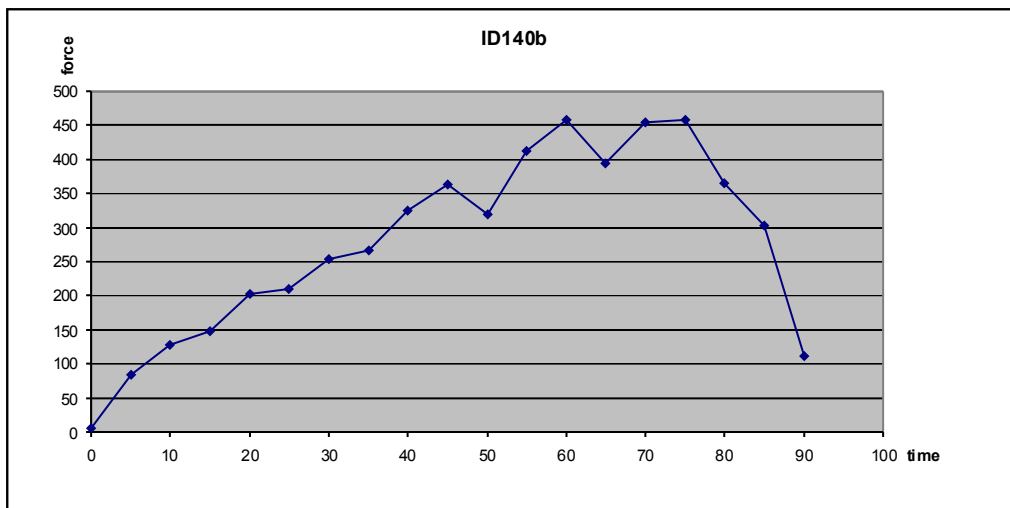
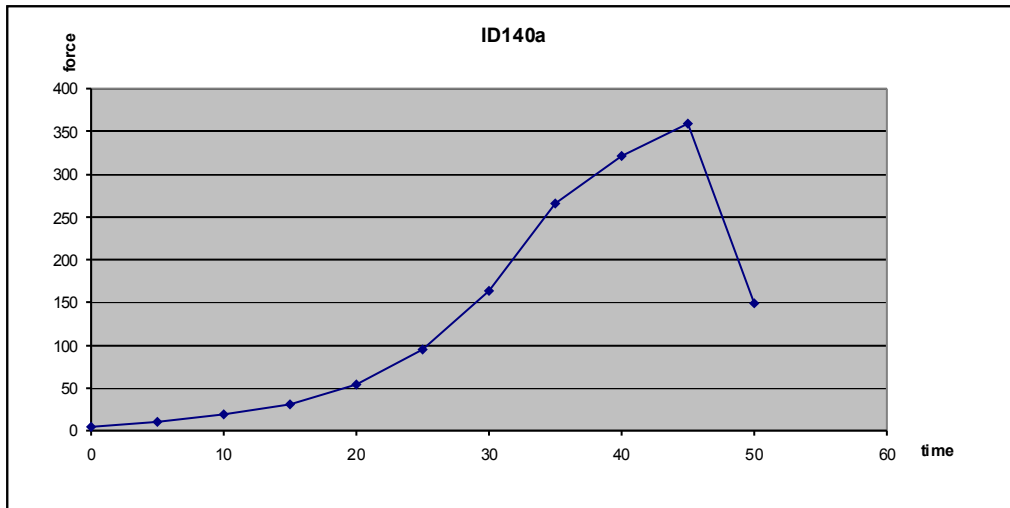

Figure 5.41 Failure graphics of sample ID140a and ID 140b

Sample-3 ID115

Table 5.5 Dimensions and test results of sample ID-115

ID number	BASE-R (mm)	HEIGHT (mm)	WEIGHT (gr)	WHORL		STROKE (mm)	
				number	TIME (sec)		
115-a	27	37	11.8	2.5	38.1	433	0.34
115-b	17	27	3.42	3.5	73.7	657	0.64



Figure 5.42 Sample ID115 cut shell



Figure 5.43 Sample ID115 tested shell

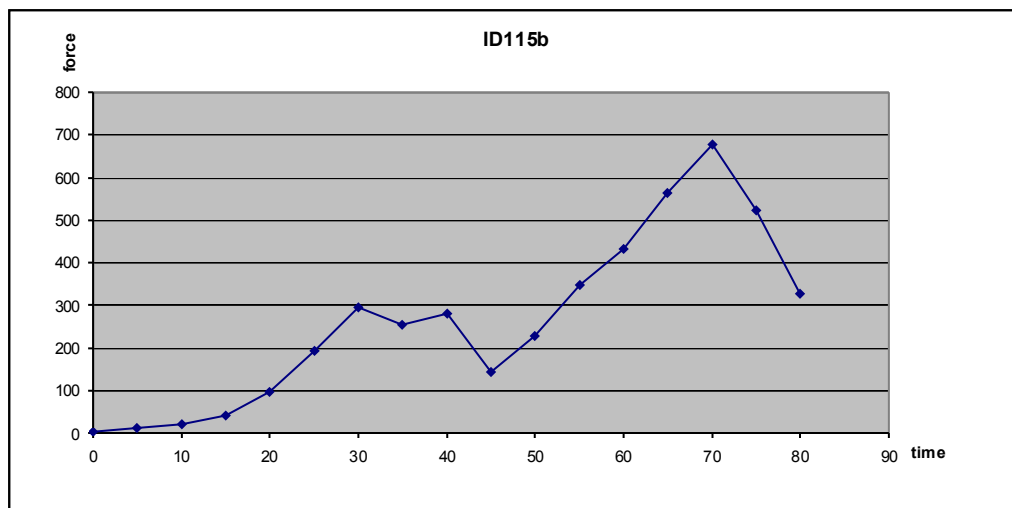
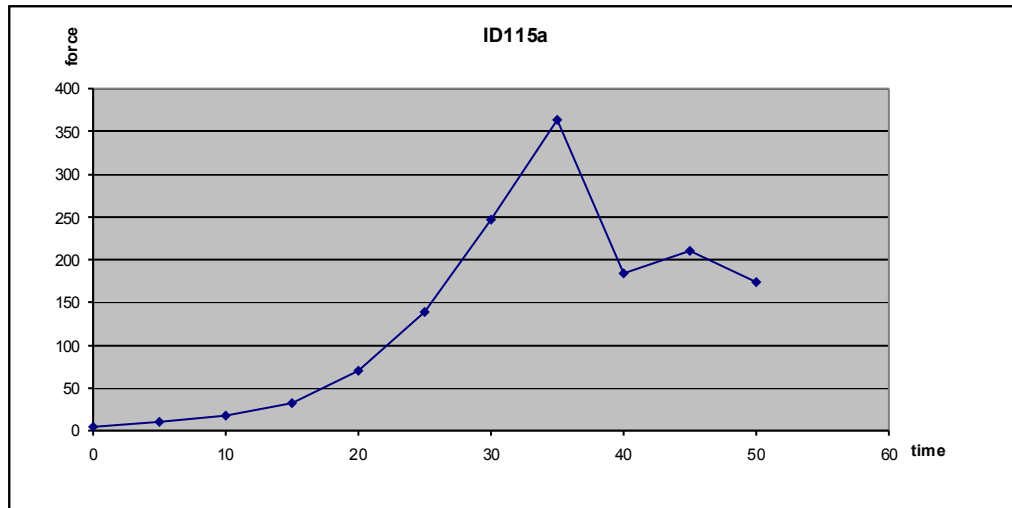

Figure 5.44 Failure graphics of sample ID115a and ID115b

Table 5.6 and Table 5.7 shows the physical behavior of samples sorted according to whorl numbers, in different range of base radius, height and weight, under compressive forces. The results are plotted on a Weibull statistics which is representing the stress-strength relation for the Turitella Terebra.

Table 5.6 Numeric values of base, height, weight, whorl numbers, time for failure, load and stroke for 43 samples (part 1)

ID number	BASE-R (mm)	HEIGHT (mm)	WEIGHT (gr)	WHORL number	TIME (sec)	LOAD (N)	STROKE (mm)
118	27	78	20.8	8	42	1000	0.38
141-b	20	22	5.54	1.5	105.95	794	0.92
144-a	27	29	10.33	1.5	42.6	486	0.38
141-a	30	32	17.18	1.5	79.8	1745	0.7
141-d	10	10	1.26	1.5	103.4	505	0.9
141-c	15	15	2.2	1.5	43.65	637	0.39
143-a	28	40	13.5	2	30.65	220	0.28
138-a	28	40	13.45	2	44.6	527	0.39
145-a	30	38	13.22	2	66.95	318	0.59
144-b	20	25	4.79	2	73.2	1142	0.64
116-a	26	32	8.8	2	122.4	2306	1.06
140-a	30	36	13.42	2	48.15	429	0.43
137-a	30	36	11.35	2	84.85	803	0.74
028-a	27	32	9.13	2	48	722	0.42
110-a	28	33	11.41	2	81.55	1266	0.71
139-c	12	14	1.77	2	93.35	699	0.81
116-b	18	21	4.8	2	89.9	978	0.67
136-b	14	15	1.35	2	70.75	306	0.62
147-a	32	34	13.48	2	44.25	776	0.39
139-a	30	31	12.93	2	129	1895	1.12
139-b	20	20	4.06	2	70.3	613	0.62
142-a	11	16	19.32	2.5	36.15	437	0.32
128-b	16	23	3.06	2.5	44.25	444	0.39
136-a	28	40	8.52	2.5	123.1	137	1.07
109-a	27	38	16.03	2.5	64.25	963	0.56
113-b	18	25	4.33	2.5	92.9	1028	0.81
143-b	16	22	2.8	2.5	60.3	473	0.54
115-a	27	37	11.8	2.5	38.1	433	0.34
128-a	27	37	12.94	2.5	46.3	631	0.41
127-a	28	38	12.12	2.5	37.35	564	0.34
113-a	28	38	14.1	2.5	93.9	663	0.82
132-a	26	35	9.2	2.5	25	379	0.23
113-c	12	16	1.54	2.5	87.8	566	0.56
110-b	19	25	3.77	2.5	75.85	837	0.66
146-a	27	34	11.43	2.5	62.7	672	0.55
133-a	28	34	11.27	2.5	155.85	485	1.3
144-c	13	22	2.2	3	53.6	425	0.47
140-b	18	29	3.91	3	71.55	472	0.62
137-b	16	25	3.16	3	38.55	349	0.34
147-b	21	32	5.42	3	58.95	791	0.52
145-b	20	30	4.63	3	64.9	625	0.57
130-a	28	42	9.5	3	49.2	945	0.44

Table 5.7 Numeric values of base, height, weight, whorl numbers, time for failure, load and stroke for 43 samples (part 2)

ID number	BASE-R (mm)	HEIGHT (mm)	WEIGHT (gr)	WHORL number	TIME (sec)	LOAD (N)	STROKE (mm)
038	24	35	6.02	3	15.75	267	0.15
146-b	17	24	3.51	3	64.8	765	0.57
112-a	28	38	12.32	3	20.75	500	0.19
116-c	12	14	1.75	3	145.7	617	1.2
110-c	11	20	1.65	3.5	91.3	469	0.8
037	23	41	10.89	3.5	88	988	0.77
042	24	42	9.9	3.5	107.05	888	0.94
040	22	38	7.54	3.5	93	595	0.82
109-b	18	31	4.97	3.5	41.05	1018	0.37
133-b	17	29	4	3.5	78.9	747	0.69
130b	13	22	14.05	3.5	50.65	593	0.46
115-b	17	27	3.42	3.5	73.7	657	0.64
028-b	17	26	2.96	3.5	35.95	311	0.32
052	23	52	8.96	4	56.05	371	0.5
135-a	27	53	15.38	4	86.8	407	0.76
053	24	45	8.09	4	63.95	274	0.57
112-b	14	26	2.83	4	78.25	469	0.69
131b	13	24	3.15	4	238.85	544	1.08
142-b	31	57	1.29	4	30.05	695	0.27
138-b	17	31	4.17	4	46.75	566	0.41
132-b	16	27	3.31	4	49.7	794	0.43
041	23	38	7.7	4	20.15	240	0.19
044	24	51	8.48	4.5	33.95	471	0.36
046	23	44	8.89	4.5	16.15	305	0.15
039	24	41	7.99	4.5	18.15	455	0.17
135-b	14	21	2.36	4.5	69.8	923	0.61
054	24	52	12.95	5	24.45	653	0.22
045	23	49	12.62	5	20.3	522	0.19
043	23	48	9.06	5	9.15	298	0.09
051	24	50	10.23	5	11.3	333	0.11
129	26	52	12.41	5	77.55	234	0.69
047	25	53	11.24	5.5	30.75	574	0.28
131-a	30	52	13.08	5.5	87.8	720	0.78
120	28	69	17.98	6	31.95	451	0.29
048	22	53	8.19	6	71.4	551	0.62
127-b	17	40	4.46	6	37.15	407	0.33
119	27	62	13.12	6	174.7	593	1.17
126	27	67	13.7	7.5	46.2	458	0.42
122	28	67	13.05	7.5	40.05	478	0.36
123	29	81	18.91	8	33.1	491	0.3
125	28	76	15.85	8	216.8	664	0.97
124	27	78	20.6	9	385.3	779	0.78
121	28	78	18.2	9	102.9	474	0.9

5.4.2.2 Results

Generally, for the statistical analysis of mechanical tests on brittle materials, and to describe the failure of those materials, one of the popular and useful statistical method is Weibull statistics. Weibull plots are often used in the design of products fabricated from brittle materials, and are used to estimate the cumulative probability that the given sample will fail under a given load. For this reason physical behavior of the randomly selected and cut seashells were obtained through experimental studies and the test results were illustrated to exemplify the behavior (Figure 5.43). The behavior on the graphics shows that the strength of a seashell is a function of its base- height ratios. Although due to impurities and defects in material properties and lack of precision in the cutting or microscopic cracks appeared during sampling operation, some fluctuations appeared in the graphs the overall behavior of the shells show that their strength is proportional with a base to height ratio. Material defects might be caused by the environmental factors and differentiation in nutrition in different seasons.

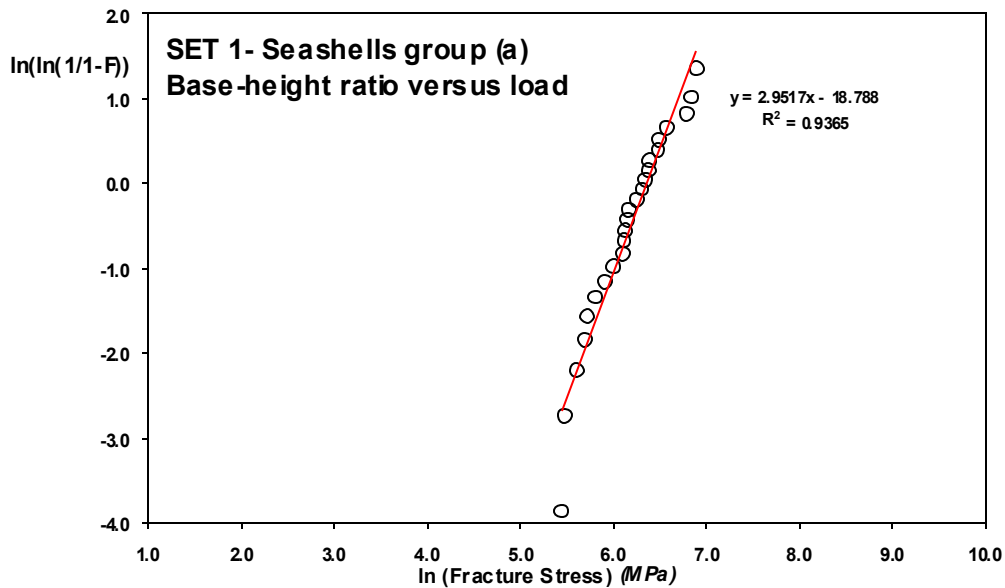

Figure 5.45 Weibull statistics of tested shells

5.4.3 Finite Element Analysis of Computational Model

The model generated for the seashell was analyzed by FEA software. The efficiency of the computational model was evaluated under the assumptions described in the previous sections, and the results were compared with the experimental results. The purpose was to inquire how the knowledge was transferred from one medium to another: from nature to man made. The model obtained through geometric relations and isotropic material assumption were analyzed by FEA. FEA is one of the efficient methods to generalize structural behavior of complex forms which are impossible to obtain through analytic methods. As mentioned, some physical impurities and surface irregularities observed on natural seashells, due to several environmental reasons are assumed to be negligible and analysis focused on gross structural behavior rather than micro structural behavior.

Even though, some of them are important structural elements for the actual seashell. Examples of these elements are the growth line on the shell, created when shell material is added to the existing rim of the aperture; the corrugated thin shell develops to strengthen the shells with lesser material used, and the **thickness** of material varied throughout the growth forms. These elements are believed to have structural influences on the actual seashell geometry. However, the structural analysis of the seashell geometry in this research will be performed only on digital seashell geometry that has a constant thickness.

The seashell structural analysis is performed using the following steps: retrieval of numerical data/digital model of the Turitella Terebra geometry, specifying of material properties, supports and loads, execution of analysis, and verification of results.

Assumptions: It is important to mention here that, as can be remembered from Chapter 5.3.2, the mathematical model of Turitella Terebra was created as two different surfaces: first, the inner shell; and second, and the outer shell, which represents the outer sine wave-type surface. For the digital analyses thickness of

the shell was assumed constant and then, structural effect of a wavy surface was considered negligible. As it is expected from Biomimetic studies which are interdisciplinary from inherent nature, this study has an interdisciplinary approach and there are some assumptions through the simulation part of the analysis. For example, material properties of *Turritella Terebra* for FEA are assumed to be homogeneous and isotropic in which material properties are all same in xyz directions although it is orthotropic and has many defects due to environmental factors. This is the third assumption after assuming thickness of the shell as constant and wave function of the surface as sinusoidal. Computational model constructed according to assumptions as well as compressive tests were realized according to these assumptions.

5.4.3.1 Preparation of Digital Model for FEA

There are several number of structural analysis packages among them the SAP2000 V.10 a civil engineering software and MSC Patran 2005r2 a mechanical engineering software were selected to perform and compare the simulation results with the experimental ones. They have both powerful calculation engine and ability to modify geometry and analyses specifically in a graphic manner, and present results graphically. To understand the ramifications of the analysis using this specific software the general consideration and description of the related issues were discussed.

It is assumed that the material assigned to the model has elastic, isotropic properties and since the analysis carried in elastic range, then SAP2000 Patran 2005 was appropriate for the analysis. Since actual shells are brittle it requires some other structural analysis tools for fracture and plastic deformation. However the model and the assumption will allow the model proposed here to be simulated with elasticity properties. Due to the assumptions the analyses was performed in elastic range and allowable stress were compared with the stress obtained through the experiment. Computational model obtained through several observations and assumptions be analyzed under the similar loading conditions form and boundary conditions used in experiments. Since the results of simulations and experiments to

be compared then sample forms, boundary conditions and loading conditions were chosen according to experimental ones.

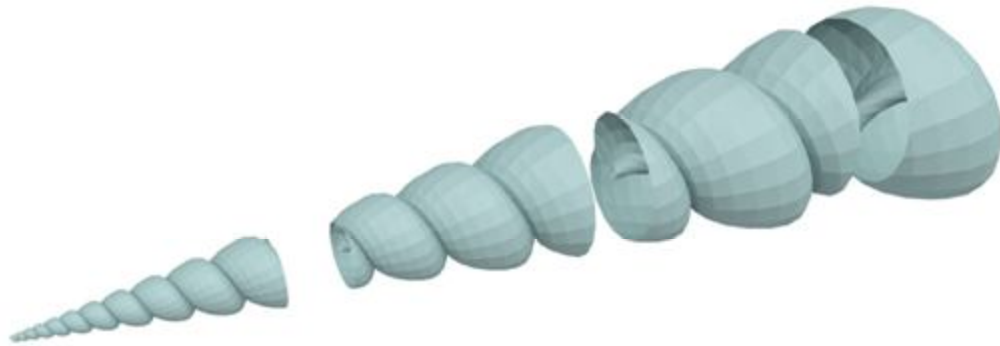

Figure 5.46 Typical cut parts of the computational model for FEA

For this purpose, data preparation/preprocessing were developed to facilitate the analysis in several steps. Firstly, the mathematical model of the *Turitella Terebra* was re-run according to the geometrical/dimensional properties of the tested shells. Among the cut shells the “b” part having common dimensions were selected which has base a radius= 20mm and height= 25 mm and whorl number = 2.5. The same process was applied to the digital model being cut to the same dimensions and prepared for the FEA. The digital model of the seashell prepared/cut in 3DMax7.0 environment (Figure 5.45), then transformed into a data environment/a domain/a file format which was “accessible” by such structural software; SAP200 and Patran2005r2.

The steps followed for the FEA procedure have been displayed in Figure 5.47

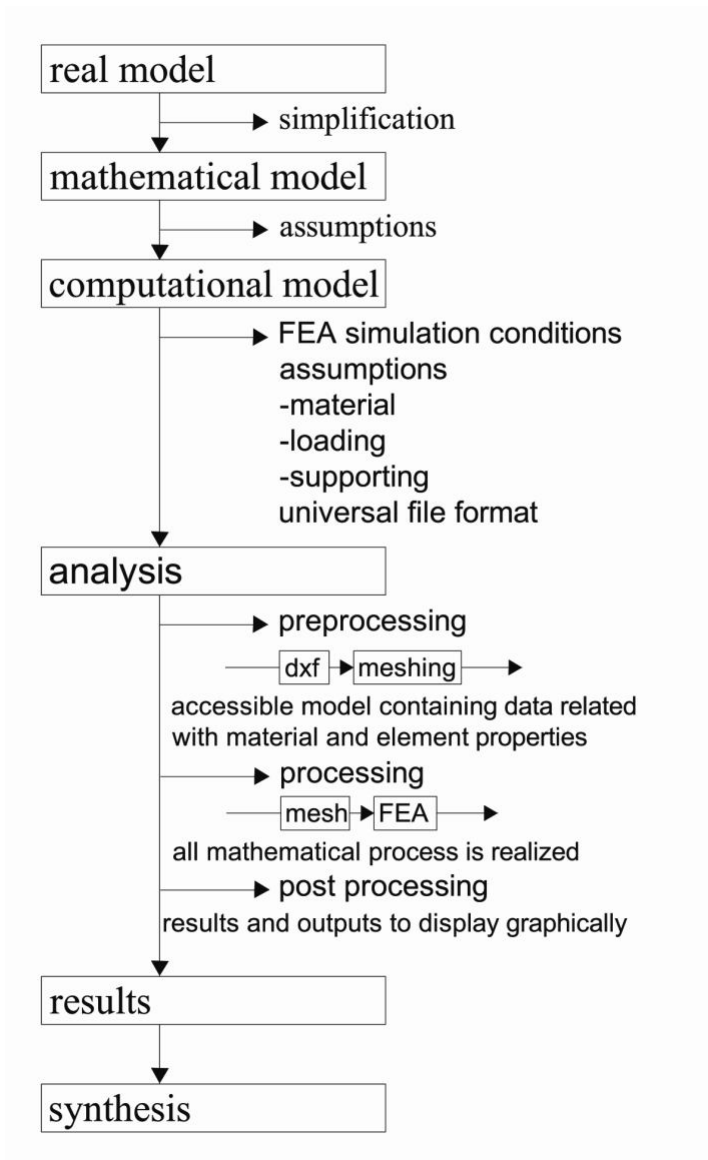

Figure5.47 Requirements of FEA process to be followed .

5.4.3.2 Specifying Material Properties, Loads and Boundary Conditions

There are two common approaches to create a structural model in SAP2000. The first approach is to create a model inside the software by using a set of commands with data numbers in the SAP2000 editor, while the second approach is to import a Drawing Interchange File (DXF) format file prepared in any CAD software. The

advantage of the second approach over the first is the ease with which complex structural forms can be created. While transferring the geometry to SAP2000, the reconstructed seashell geometry was in the original scale of unit mm. Similarly MSC Patran 2005r2 has different approaches to create a structural model; however as mentioned ACIS format of digital model was imported and the following steps were applied.

Once the structural geometry of the seashell was reconstructed, the next step was to specify the material and its properties to the geometry. The material was assumed as a typical calcium carbonate which is very similar to Turitella Terebra in nature and important characteristics like modulus of elasticity was agreed to as 35000 MPa, and Poisson's coefficient was accepted as 0.27. The thickness assumed to be constant and it was chosen as 1 mm which was very similar to Turitella Terebra.

Table 5.7 Typical physical properties of calcium carbonates (Source: <http://www.calcium-carbonate.org.uk/calcium-carbonate.asp>)

Typical physical properties of Calcium Carbonates	GCC = Ground Calcium Carbonate PCC = Precipitated Calcium Carbonate
molecular weight (Dalton)	100.09
density (kg l^{-1})	2.71
Mohs' hardness	3
decomposition Temperature ($^{\circ}\text{K}$)	from 1150
Young's modulus (MPa)	35000
Poisson's coefficient	0.27
acoustic transmission speed (m/s)	1400
surface tension (mJ/m^2)	207
thermal conductivity (W/K.m)	2.4-3.0
specific heat ($\text{kJ kg}^{-1} \text{K}^{-1}$)	0.86
linear coefficient of expansion (K^{-1})	$9 \cdot 10^{-6}$
dielectric constant	6.1
specific volume resistivity (Ohms/cm)	$1 \cdot 10^{10}$

Both software are capable of calculating both distributed loads and joint loads on the surfaces or joints. Like in the mechanical compression tests, loads are assigned to the symmetry center (Global Z direction) of the upper part joints (Figure 5.48). For the both models 1000 N was loaded to see the behavior of the shell.

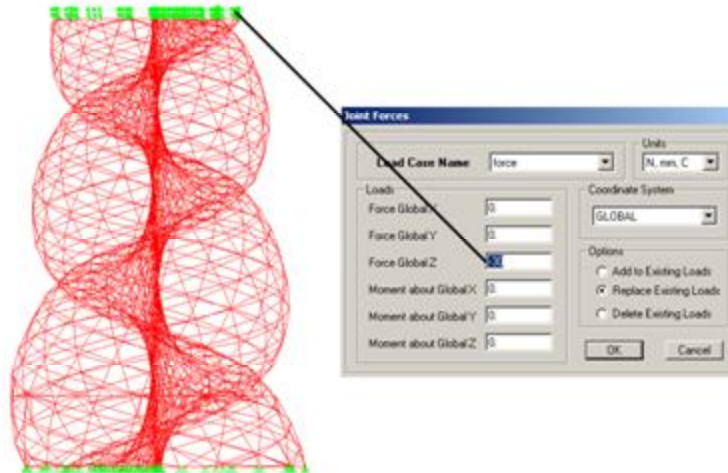

Figure 5.48 Loading conditions of SAP2000 model

Here the boundary conditions and the position of the seashell, which has many possibilities in its natural environment, assumed to be bounded to the ground as in the experiments. The exact support location of the actual shell is almost impossible to define, as it depends on the shell orientation in its living environment and the nature of the environment itself, such as sand, mud, or rock. These undefined situations direct the research to develop an assumption of the support condition. The support assigned in this research simulation is located around the bottom surface of the cut shell, as the **same** in the mechanical compression tests, so that the results will be harmonious. From the SAP2000 **assign** menu, **joint restrictions** were selected as pinned and assigned to the selected joints. The pinned-type of supports restrain all three translational degrees of freedom, as illustrated in Figure 5.49. Similarly, boundary conditions were assigned as **fixed** for the computational model created in Patran.

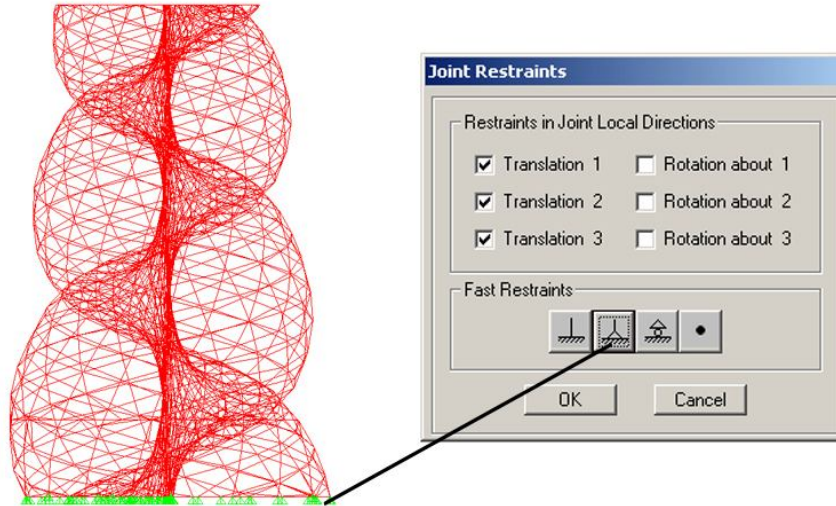

Figure 5.49 The revised geometry with the supports and type of joint restraints of SAP2000 model.

Different from SAP2000 Patran software computes a mathematical model in three steps: first, pre-processing is realized in which **ACIS** file (the geometric model) from AutoCAD is important to Patran, material and element properties are defined and boundary conditions are decided here. Second, prepared input file is opened in NASTRAN all mathematical process is realized in here and this step is called processing. And finally in the post-process step, results and outputs are imported to Patran again to display the graphical results. For the seashell geometry, the most useful result for structural evaluation is the color pattern. In this particular analysis, the element stress output indicates two important results: von Mises shell stress (SVM), and Resultant von Mises Forces (FVM). A color code indicating the values is provided to allow easy evaluation of the graphic results.

5.4.3.3 Results

The results of FEA show structural performance of computed sample in the output file which automatically produces the geometry information, the analysis result and revealing potential error ranges in the analyzing process as well. In the FEA

interface it is possible to see stresses concentrated in the digital model. There are many display tools to enhance graphical representations of these structural behaviors. As can be seen from the shell stress diagrams obtained from two different FEA software, stress generally concentrates on the upper part and most of the stress is transferred through the rigid spine in the center of shell which prevents failure of the surface. The stress patterns obtained through the analysis show that the majority of compressive forces are on the upper part where it is directly exposed to the loading.

The graphs in Figure 5.50 show that the simulation results have very similar behavior with the actual structural behavior observed in experiments. Hence the computational model obtained through observations and assumptions explained in detail in previous sections, is adequate to represent structure behaviors of the seashell under given loading conditions.

Several simulations were performed for different shells having different base to height ratios and similar results were obtained. One of the analysis results were given in Figure 5.50, Figure 5.51, Figure 5.52 that represents the overall behavior of shell structures in FEA medium.

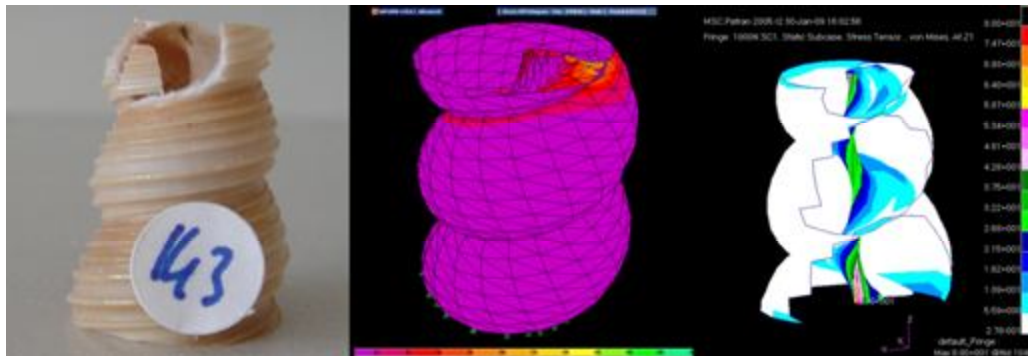

Figure 5.50 Graphics showing failure in a real shell and Von Mises Shell Stress diagram of Sap2000 and Patran

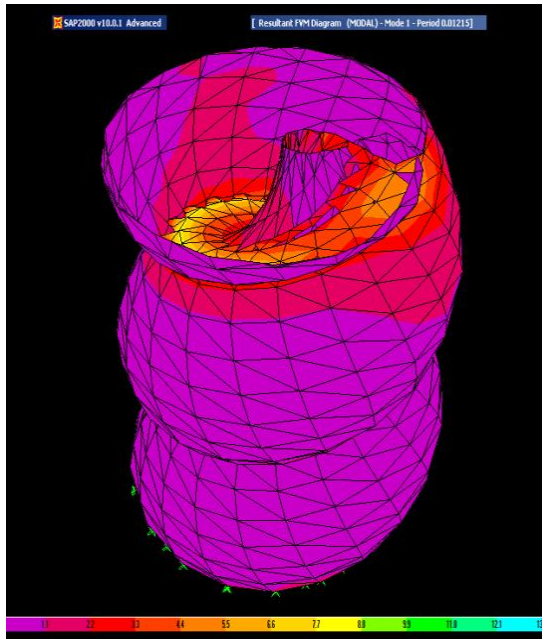

Figure 5.51 Graphical result of Resultant Von Mises Forces diagram of Sap2000



Figure 5.52 Graphical result of displacement diagram of Patran

5.5 Synthesis : Introduction to Non-Dimensional Parameters

As a dictionary definition, a non dimensional parameter is the parameter of a problem with a value that is independent of the units of measurement. In other words it is a quantity without any physical units and thus a pure number. One of the most important properties of non dimensional parameters is that it constitutes “values” to compare incomparable quantities by referencing each other. Similarly, non dimensional parameters are important to compare the domains having different references.

In daily life non dimensional quantities are extensively in use such as Poisson’s ratio, absorption coefficient or pi number. In engineering, where learning from nature is relatively widespread, the usage of dimensionless quantities relate with the transferring knowledge obtained from nature to the solution of a specific problem. Thinking with non dimensional parameter resulted in many important developments in engineering. For instance Mach number is a ratio of speed of a man made object moving through air, or any fluid substance divided by the speed of sound, drag coefficient playing an important role in aerodynamic calculations and many others allowing to “evaluate performance” regarding to different media with different references/restraints/domains. Dimensionless physical constants developed in physics and cosmology brought about knowledge to understand the world and the universe. There are many non dimensional parameters, and most of them are more complicated, employed in engineering in order to learn “systematically” from nature instead of observing it.

For architecture the new way of learning from nature might be thinking via non dimensional parameters. For this reason the results of experiments are synthesized by the non dimensional parameters gathered through the experiments.

During experiments some unexpected results like 200 N or 2000 N were seen due to some possible defects in test materials occurred in pre and post faces of the

experiments hence they are statistically discarded. Both the experiments and simulations have shown that structural behavior of the seashells and their strength to compressive forces can also be expressed a function of base to height ratio which is an indicator to decide on the dimensions of shell. The data gathered from the tested shells sorted according to base/height ratio in the EXCEL file and they are grouped. Then the loads were organized along with the increasing base/ height ratio. The average value of each base versus height ratio group was calculated. It was seen that when the ratio increased loading capacity also increased. It can be concluded that the shells with higher base ratio stands higher loads. This behavior is shown in the Table 5.8 where the characteristic base-height ratios with corresponding average loading before fracture. This summarizes the detailed behavior of 86 test sample.

Table 5.8 Representing base-height ratio range to load

base/height ratio	0.35-0.38	0.40-0.48	0.50-0.59	0.60-0.69	0.70-0.76	0.79-0.86	0.90-1.00
load (N)	543	548	628	649	662	869	931

Later the same data grouped in relation to cut places namely; a, b, and c parts and analyzed separately. Relations for the “a”, and “b” parts are tabulated in the following tables. For the “c” part is disregarded due to poor number of specimen to evaluate. From the tables, it can be concluded that there is obvious orderly ascending relation among the loading capacity and increasing base-height ratio, increasing weight and increasing whorl number.

Table 5.9 Representing base-height ratio range to load relation for the “a” parts of the sample space

base/height ratio	0.35-0.42	0.44-0.48	0.50-0.61	0.67-0.74	0.79-0.85	0.93-0.97
load (N)	500	530	560	660	950	1400

Table 5.10 Representing weight to load relation for the “a” parts of the sample space

weight (gr)	7.54-8.18	8.48-9.20	9.50-10.89	12.12-14.00	15.38-16.03	17.18-20.08
load (N)	380	450	820	670	750	820

Table 5. 11 Representing increasing whorl number to load for the “a” parts of the sample space

whorl number	1.5-2	2.5-3	3.5-4	4.5-5	5.5-6	7.5-8	9
load (N)	500	540	560	550	570	620	630

Table 5. 12 Representing base-height ratio range to load relation for the “b” parts of the sample space

base/height ratio	0.43-0.59	0.62-0.67	0.70-0.76	0.8-1.00
load (N)	580	630	760	880

Table 5. 13 Representing weight to load relation for the “b” parts of the sample space

weight (gr)	1.29-1.35	2.36-3.51	3.77-4.46	4.63-5.54
load (N)	500	590	710	890

Table 5. 14 Representing increasing whorl number to load for the “b” parts of the sample space

whorl number	2.5	3	3.5	4	4.5
load (N)	670	690	750	800	900

From the tables it is possible to argue that apart from base to height ratio some other ratios might be introduced such as weight to whorl number, base to whorl number or weight to surface area. The behavior seen in the tables, shows the relations abstracted from the form itself. These relations reveal some parameters that can be learnt from those. It is possible to learn from the tables that when the base to height ration closes to 1 then the shell stands maximum forces. This little information gives the fundamental knowledge of how a man made shell could be

dimensioned. Because a man made shell takes shape basically according to the dimensions of area to be covered and the height which are the basic elements of creating a space. Although this reference is small and has been derived from a small case, it serves to solve a big problem in architecture: dimensioning of a shell.

From the FEA results it is proved that the computational model has been working properly. Through different experiments with this model, such as, differentiating the material, the ratios or even the form itself, several analyses can be done to generate different knowledge which will serve architecture from the structural point of view. It is also possible to argue that, if the limitation range is known relating for example base-height-load relationship, then required initial conditions for the optimization would be satisfied. For this case, learning from these relations would be a starting point as a “wise guess” to design shells inspired from nature.

To exemplify how to use the knowledge gained through experiencing shells in nature 3 different tapered cones, which is an abstraction of seashell commonly used in architecture as well, have been designed. All of them have same base radius as 10 meters and same top radius as 6 meters. Their heights were differentiated consecutively as 5, 8 and 10 meters as the dimensions which might be used in architecture. The base height ratios of the tapered shells chosen according to the ratios of seashells, experienced in the experimental and simulation results of the Biomimetic process. They were drawn in AutoCAD and prepared for FEA in Sap2000. During the analysis their materials were selected as concrete and bounded with fixed restraints. Three models were also subjected to the same loading conditions as 100.000kN to see the behavior of different base to height ratios. The Figure 5.53 below shows that the higher base to height ratio stands the more loading conditions before failure.

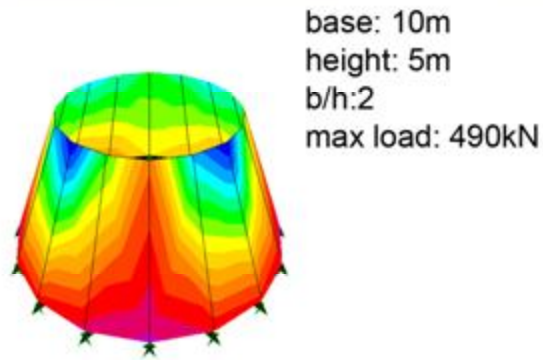
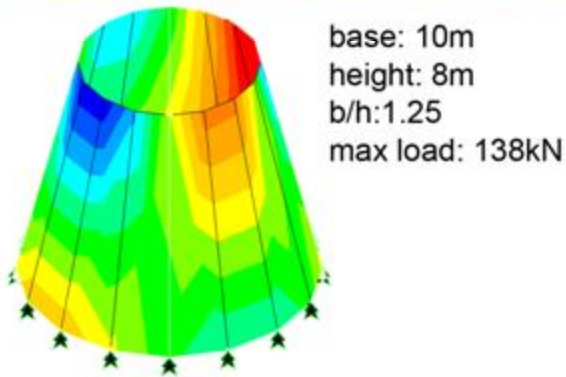
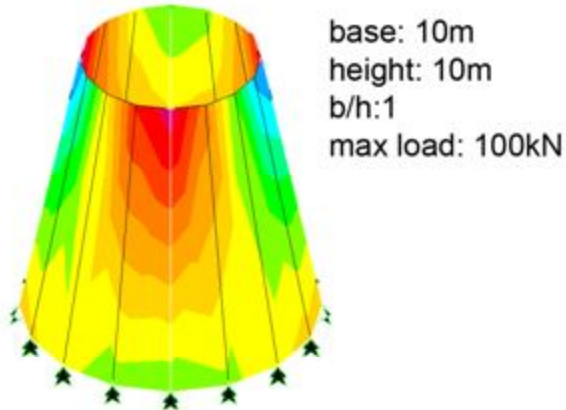

Figure 5.53 Demonstration of the working “base to height ratio” relation with loading on a tapered cone

Interestingly, a few domed buildings examined from the historical masonry mosques more recently built concrete dome buildings and it is seen that the base diameter to height ratios were close to 2 in Hagia Sophia which was built in 537. Similarly in the mosques built by Sinan this ratio is coming closer to 2 when his knowledge and experience is enhancing through the years. It is possible to argue that in the circumstances where the geometry is wise, these ratios are important to take into consideration.

Table 5.15 Diameter to height ratios of some important dome structures (Source: <http://archnet.org>)

building	construction year	diameter/height ratio
Ayasofya	537	2.02
Mahmut Paşa Mosque	1464	1.69
Fatih Mosque	1470	2.01
Sultan Beyazid Mosque	1486	1.31
Şehzade Mosque	1548	1.63
Süleymaniye Mosque	1557	1.64
Kara Ahmet Paşa Mosque	1558	1.64
Rüstem Paşa Mosque	1561	1.84
Mihrimah Sultan Mosque	1565	1.54
Lala Mustafa Paşa Mosque	1565	2.03
Selimiye Mosque	1574	1.97
Sokullu Mehmet Paşa Mosque	1577	1.62
Azapkapi Mosque	1578	1.74
Kılıç Ali Paşa Mosque	1580	1.50
Meclis Mosque	1987	1.97
Ataevler Merkez Edebali Mosque (the biggest domed mosque in the world)	2008	1.36

Briefly, here an exemplification is performed on a type of shells in nature to show that the proposed systematic represents a thinking platform for a new learning environment. Case could have been any case to signify the methodology and thinking cycle discussed throughout this thesis. To sum up, non dimensional parameters might be thought as a fundamental reference to associate two different domains: nature and man made environment.

CHAPTER 6

DISCUSSIONS AND CONCLUSIONS

In this chapter, the conclusions reached at the end of the study entitled “Proposal for a Non-Dimensional Parametric Interface Design in Architecture: A Biomimetic Approach” are presented. In addition, recommendations and suggestions for further studies are also made.

6.1 Conclusions

It can be seen that developments in basic sciences throughout history in such realms as chemistry, physics, and mathematics had a marked affect on the 19th and 20th centuries, giving rise to many technological developments. Today, it is possible to argue that biology has the potential to make contributions to the scientific developments of this century. In the last decade the results of a number revolutionary researches stemming from biological studies, such as cloning, DNA, genetics, stem cell etc., have entered our daily lives. Additionally, developments in digital and information technologies, such as artificial neural networks and genetic algorithms in engineering; robot prosthesis and artificial organs in medicine; complex systems, chaos, fractals, and Hopfield networks in applied sciences; and many other examples across a wide spectrum of disciplines, have increased interdisciplinary interaction and have played a key role in facilitating new integrated researches, such as in nanotechnologies. Hence, the potential that biology offers to researchers in science and design in terms of “inspiring/learning/adapting and/or implementing ideas from nature” cannot be underestimated.

Biomimesis, which can be summarized as learning and understanding the “probable solutions and potentials in nature”, is an interaction between many disciplines that actually gathers those disciplines and introduces the need for methods and systematic for each discipline. After gaining experience by observing nature, mankind has learned to take lessons from it as both a measure and a mentor.

According to many researchers from different disciplines, if this learning process continues and becomes commonplace a “Biomimetic revolution” will be experienced in the coming years.

When the scope of architecture is considered, the highlighted point in the most of the discourses regarding the next generation of architecture is that biological data is going to create new paradigms in that field as well. In this context, this study argues that “biomimesis in architecture” is a paradigm that can be concluded as learning from the relationships of multi-dimensions and multi-parameters, such as mathematical, formal, structural, material, spatial, functional etc. properties of natural organisms to design optimized architectural structures beyond copying their shapes. In other words, biomimesis is a code for the correct association of all of these parameters.

This thesis provides a platform for discussion on the subject of “what can architects learn from the formation processes in nature with the help of the rapidly developing digital and information technologies, beyond formal and visual inspiration?” In the first step of the study, answers to the questions of “what is biomimesis”, and “how has it taken place in science and technology?” has been investigated. In this process some remarkable examples of Biomimetic studies are given, and thoughts for the future by a number of researchers are evaluated. To introduce the subject of “what is Biomimesis in architecture the first step was to review the relationship between nature and architecture throughout history, and then to list the architectural artifacts inspired by and emulating the formations and phenomena in nature. From this list, the study focused on 20th century architecture. At the end of the research on 20th century architecture, by taking the computation, representation, construction, and material technologies of that period into consideration, it was concluded that natural inspiration in architecture is a kind of visual expression – except from Otto’s and Fuller’s designs – and many of them were constructed by and over design just to set an analogy between natural forms and architectural forms. Just the same these buildings are mentioned as the pioneering examples of their periods in the literature of architecture.

The research to convey the real meaning of Biomimesis in architecture began with a classification of the living and non-living form structure groups in nature that inspire architects, and then a determination of the structural properties of those main groups was considered. Different from man-made structures, one of the most determining properties observed in natural structures is that form, function, structure, and material come into existence simultaneously. From the literature survey it is seen that to be able to analyze such kind of properties has a potential to form architectural design paradigms. Therefore, the prominent architectural structures emulating natural structures are classified into five main groups: tree-like, web-like, skeleton-like, pneumatic, and shells. The properties of each structural group are studied, considering the examples stand out with natural resemblances and then the scope of the natural inspiration is discussed.

After this phase, it is seen that all those examples have an important place in architectural literature, and yet all are the result of form-finding processes. It is also clear to see the success behind these. It is inevitable to notice that the “success” which is a result of this search, the consciousness of the operation in nature is parallel to the development in observation and calculation technologies. In recent examples we witness that the striking forms, designed with the help of modern computer technologies, are also related to natural forms.

Although it is not realistic to make an absolute definition or draw the outline of Biomimesis applications in different knowledge fields, since these applications may end up with very different and unexpected results because of the correlations of technologies and fields, yet there are different provisions for each field. One of them suggests that “Biomimesis” could have three main fields of application in architecture: in the production of more resistant, stronger, lighter, self-combining, and self-repairing materials; in the climatization of the buildings and the built environment; and in the creation of a sustainable, recyclable built environment that allows the reuse of waste materials without consuming but producing resources.

Without doubt, the implementation of these expectations in the field of architecture will contribute to the sustainable environment, which is a subject that is being discussed in many fields at present. However, the point to be discussed and questioned here is how to transfer this interaction/language to different fields specifically to architecture. Considering the multi-dimensionality in the inspiration/learning/adaptation from nature and/or applications arising from it, as well as the complexity and versatility which require a cooperation of discourses, computational calculation methods and the intense use of computer and informatics technologies, it is a must for each field to develop its own systematic and methods, in other words “**methodology**.” It must be expressed that in learning from nature one should focus on understanding the process and should base thoughts on concrete/constructed data, rather than a formal analogy.

6.2 Introducing Non-Dimensional Parameters as a Base for Learning from Nature

As it is discussed in the previous chapters of the thesis, the potential that biomimesis offers to researchers in science and design in terms of “inspiring/learning/adapting and/or implementing ideas from nature” cannot be undervalued. The point need to be highlighted here is that biomimesis, as a well defined scientific domain, impose a way of thinking and a system design to transfer the answers/knowledge it contains. For the disciplines like engineering, medicine, agriculture and cosmology that are transferring the Biomimetic knowledge to their domain knowledge, has been developing a way of “computational thinking” evolved in accordance with the developing technologies. The question of “what about in architecture” has motivated this study. It is already experienced in many engineering disciplines that, “parametric thinking” and as a consequence non dimensional (dimensionless) parameters are employed to relate different media having different origins and/or references.

As for architecture, where there is a close relationship with nature, methodologies need to be developed for specific answers could be learned from nature. Those answers might come up with new smart technologies and optimum designs based

on performance like reducing energy and material usage, diminishing ecological footprints and increasing stability that can be seen already in nature.

For architecture the new way of learning from nature might be thinking via non dimensional parameters. As a long service method in engineering non dimensional thinking should be explored in architecture as well. By the way, each discipline should deal with generating its own language. This study tries to find that language in architecture. From this point of view this study constructed and proposed a “parametric thinking cycle” as a methodology to inquiry the real meaning of biomimesis in architecture on a shell case. Figure 6.1 shows this proposed cycle with the case used for an exemplification in this thesis.

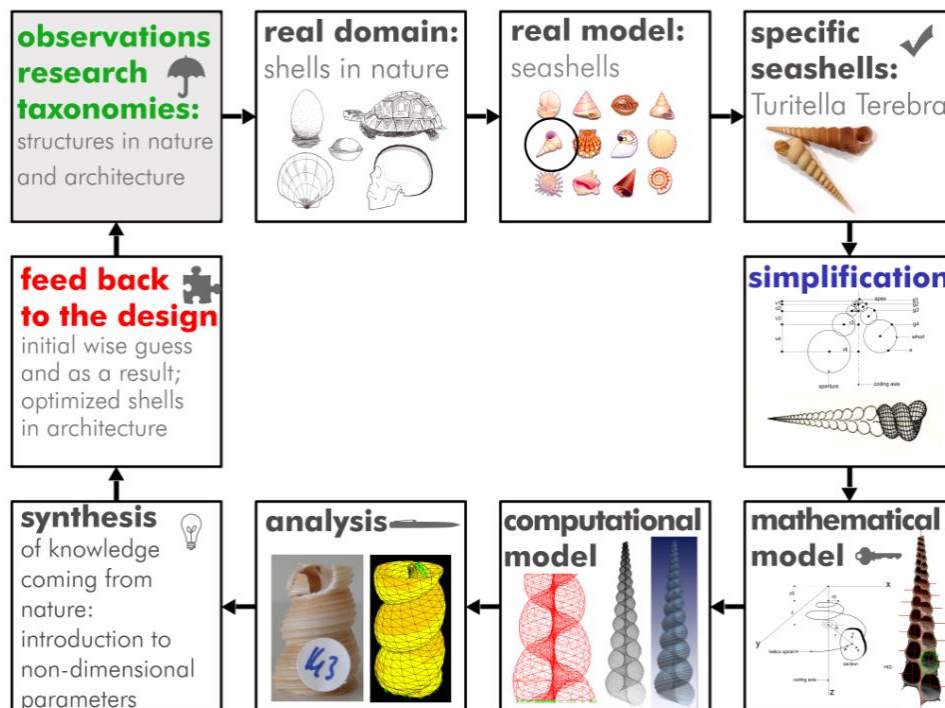

Figure 6.1 Proposed methodology for learning from nature a case on seashells: Biomimesis in architecture

The first step to develop non dimensional quantities derived from nature is asking the correct question to start a research. This phase is called as “real problem”. Then the changing/improving observation tools are one of the most important tools to understand how nature works, what is the life span of that particular natural object, why is that system generate as it is *etc.*. At that time an enhanced knowledge of studied/selected natural object is required to relate the real problem to man made objects. Mathematical model of the real problem can be constructed by appropriate simplifications. Mathematical model can be transferred to a computational model by correct assumptions. The level of assumptions defines the precision of computational model and thus precision of results. In the next stage results should be evaluated to relate with a man made object. At this point non dimensional parameters could be set into design problem as a fundamental for initial wise guess. In the final phase non dimensional parameters might be discussed and compared by designing related man made object. This process/type of thinking illustrated on a man made shell example (a tapered cone) shown in Figure 5.53. The form studied here is the abstraction of a seashell and it is inquired through this example is how the knowledge gained by Biomimetic analysis is to be reflected to the design process. Parameters, which are derived through the analyses of seashells illustrated in previous sections, are employed to decide on initial decision steps to relate the form and space quality

The main difference which the author aims to emphasize in this thesis is that methodology is important in the reflection of Biomimesis on architecture, and that this multi-dimensional and multi-disciplinary concept could be transferred to another discourse, i.e. architecture, accurately and efficiently only with a developed method. In order to develop a methodology in architecture, what the simultaneous formation of structural-material and formal properties of living and non-living things, “Biomimesis” may change in architecture could give clues. At present, it is accepted that architecture and design are undergoing change, and that informatics and computer technologies have transformed the design concept from a result to an interactive process. In this transformation phase, including “Biomimetic” parameters in the process will help in perfecting/optimizing the design. Learning from the form-

structure-material triplet is possible by making algorithmic thinking a part of architecture and developing analogies using computational and/or analytical models.

In this context, in the exemplification chapter of this thesis, the author focuses on “shells” in the classification, illustrating the relationship between nature and architecture. Shells started to be designed and produced extensively, especially with the development of concrete technology, after which developments in material technologies, such as reinforced concrete, steel, plastic, and composite materials, have been rapid. Another important factor affecting this production has been the increase of technologies used for the complex calculation methods required for buildings with large spans using the minimum of materials, such as shells. Along with this, the manufacturability and/or constructability of curved surfaces have increased with the advancement of CAD CAM technologies, making shells one of the most important structures of the century.

The main motive for developing a “methodology for learning from nature in architecture” is the extensive use of the seashell as a metaphor in architecture for centuries, and the definition of architecture at the very first phase by space-form-structure and material in the design of the 20th century product shell. With this aim, firstly a brief Conchology search was carried out, and the Turitella Terebra exemplification study which is commonly used in architecture and whose complex geometry shall be parameterized with the help of some main abstractions, was held. Since no such shells are available in Türkiye, 150 shells were brought from abroad. The shells were categorized by height, whorl number, and base ratios and photographs were taken and documented.

After that the mathematical relations of the sea shell, which define the form and structure so the space of the shell, were tried to be solved. Since this analysis could not be made in two dimensions, making a mathematical model which will define the complex geometry of the seashell was needed. Previous models formed by a number of mathematicians, biologists, paleontologists, and software experts were studied, and deficiencies were detected. Following this, the studies of making the

computational model of Turitella Terebra continued at Bath University in the UK. A model which was thought to represent Turitella Terebra in the best way was developed. The methodology developed in the second phase of exemplification, composed of the stress analysis and compression tests of documented shells, and then of shell pieces cut similarly, and lastly an evaluation of the collected data. The first step of this was evaluating the data in order to understand the relationship between geometry and stress resistance. After the mechanical tests, both in order to see the accuracy of the digital model and the reliability of the mechanical tests, the same physical conditions were created in the digital media and tests were redone using the FEA method.

The next phase of exemplification was composed of the stress analysis and compression tests of documented shells. Shell pieces cut similarly, evaluation of the collected data tabulated. The first step of this was evaluating the data in order to understand the relationship between geometry and stress resistance. After the mechanical tests, both in order to see the accuracy of digital model and the reliability of mechanical tests, the same physical conditions were created in the digital media and tests were redone using FEA method. This was also an attempt to understand the precision/correctness and workability of computational model.

It is believed that assembling the quantitative data with visual models and using these models investigating quantitative methods for transferring them to architectural design and including in architecture shall be an accurate exemplification study. The distinction of this study among similar ones is its emphasis on the necessity that inspiration from nature shall not be restricted in formal aspect, and that the design process shall be important in architectural design. Potential relationships established with the help of analogy and experimental studies done by using the digital models, are believed to make a start for new design methods and innovations in architecture and in this way an interdisciplinary platform for discussing "Biomimesis in architecture" objectively is believed to be constituted.

Besides those issues discussed above the following conclusions are arrived at:

Using mathematics as an investigation tool: In this research it is seen that mathematics is a meta language to investigate the relationships among rules of generation of form, function, structural behavior in natural structures. All complex “real problems” are mostly ill defined for the researchers due to such huge numbers of parameters and variables. Mathematics at that point is the one of the most important/only tool to analyze and understand a natural object or phenomena as a real problem. Therefore, while learning from nature, the tendency is first to create a mathematical model as an abstracted/simplified version of the problem which results in the computational model soon. Similarly in architecture, our perception of nature has been changing through the impact of the developing computational technologies and tools. Basically, abstraction/simplification of natural complex forms/structures by mathematical models would be a starting point to explore inspiring forms.

Demonstrating the reasoning scientific process of understanding-abstracting- modeling of a natural structure: The research proved that scientific approach on the study of seashell geometry, provides knowledge of how a natural form might be modeled. This particular approach gives valid and definable result, which can be developed to find the answers of biomimesis in architecture.

Introduction of non-dimensional parameters Information gained through the analysis of shells fundamental knowledge of how a man made shell could be dimensioned can be questioned. A man made shells generally take shape according to the dimensions of covered area and the height although the references obtained from non dimensional parameter is small it serves to solve several problems in architecture. To sum up, non dimensional parameters might be thought as a fundamental reference to associate two different domains: nature and man made environment.

Parametric thinking as a keyword in computational design: Actually, even the development of parameters requires development of a method. The question of “which parameters to use and what are the dependencies of parameters to each other” defines the success of a computational design. Designing a parameter is

related with the knowledge designer have and expected precision and learning outcome. To sum up, designing the correct parameters (like base to height ratio) will result in a success in an engineering design.

Incorporating “forces” that shaping the design: man made in nature: it can be said that forms in nature are manifestations of the phenomena of forces. These forces shape the forms and structures. As the same, a man made shell abstracted from a seashell is designed by using the non dimensional parameters obtained through the experiments and simulations and optimized by applying the forces.

The future of thin shells: New computation and construction technologies together with the developments in material industry seem to make possible with shell structures to span large areas with less material. This tendency will inspire designers and will start a new era for next generation spatial structures inspired from nature.

6.3 Recommendations for Future Studies

For the possible developments in architecture, recent Biomimetic studies could be followed and the potentials of interdisciplinary studies could be explored with in the framework of the “systematic thinking” proposed here. In this study only structural behavior of a natural and man made objects namely shells were investigated as a function of proposed methodology. Another type of natural and architectural structure could be investigated for further learning from nature.

Further more, different aspects of architectural discipline such as material production and its use, tectonics; manufacturing can be explored more in future, focusing on further researches on microstructures of seashell material and its structure having a potential to develop an earthquake resistant material and structure for man-made buildings.

Regarding the recommendations for the case studied here, as explained before, there were some assumptions throughout exemplification of the case study, such as in developing mathematical model, computational model and experiments. For further studies these assumptions can be refined and the models could be improved with developing technologies and the results can be compared to see how the precision affects the non dimensional parameters for initial wise guess.

There are some points that are not covered within the frame of this study. For example a shell structure with its architectural program, structural details and material properties could be explored by using the methodology propose in this dissertation. From this point of view, the method could also be used for further investigations according to other building structures inspired from nature.

Further studies could also be research on Biomimetic studies related to architectural discourse (Table 2.1). Moreover the revision of individual examples and periodic styles representing nature architecture relationship could be enriched to consolidate the idea behind it: changing paradigm in architecture (Table 2.2). Recent architectural examples could be added to enrich the classification given in the thesis (Table 3.1), besides the classification could also be enhanced such as by adding kinetic properties of mention structures or constituting new structural typologies like armadillo like structures, fish like structure, flower like structures and which are quite popular recently among architects.

REFERENCES

- ABBOTT, R. Tucker. 1954. *American Seashells*. Van Nostrand,
- ADDIS, B. 1994. *The Art of the Structural Engineer*. Artemis Ltd. London.
- ADDIS, B. 2001. *Creativity And Innovation The Structural Engineer's Contribution To Design*. Oxford: Architectural Press.
- ALEXANDER, C. 1964. *Notes on the synthesis of form*, Harvard University Press. Cambridge.
- ANTONIADES A,C. 1992. *Poetics of Architecture: Theory of Design*. Van Nostrand Reinhold, New York.
- ARSLAN SELÇUK, S. and GÖNENÇ SORGUÇ, A. 2004. Similarities in Structures in Nature and Man-Made Structures: Biomimesis in Architecture the *Proceedings of the 2nd Design and Nature Conference Comparing Design in Nature with Science and Engineering*, Wessex Press, England.
- ARSLAN SELÇUK, S. and GÖNENÇ SORGUÇ, A. 2005a "Biomimesis in Architecture: Inspiration for Next Generation Po(r)table Buildings" *Transportable Environments III*, Edited by Robert Kronenburg, Taylor & Francis, Toronto.
- ARSLAN SELÇUK, S. and KUMKALE, E. 2005b. Biomimesis: Architectural Inspiration For The Future, *the Proceedings of the 5th International Postgraduate Research Conference in the Built and Human Environment*, Salford.

- ARSLAN SELÇUK, S., FISHER, A., and WILLIAMS, C. 2005c. Biomimesis and the Geometric Definition of Shell Structures in Architecture *the 8th Generative Art Conference GA2005*, Milan.
- ARSLAN SELÇUK, S. 2006. Mathematics as a Tool to Evaluate Biomimetic Inspirations: a Study on Seashell Modeling. *the Proceedings of the 1st International CIB Endorsed METU Postgraduate Conference on Built Environment and Information Technologies*, METU Press, Ankara
- BALDWIN, J. 1996. *BuckyWorks: Buckminster Fuller's Ideas for Today*. John Wiley & Sons, Inc. New York.
- BENYUS, J. 1997. *Biomimicry: Innovation Inspired by Nature*. William Morrow and Company Inc., New York
- BERGER, H. 1996. *Light Structures, Structures of Light*. Berlin: Birkhauser,
- BEUKERS, A. 1999. *Lightness. The inevitable renaissance of minimum energy structures*. 010 Publisher, Rotterdam.
- BILLINGTON, D. P. 1982. *Thin Shell Concrete Structures*. McGraw-Hill, New York
- BRUSCA, R., BRUSCA, G. 2003. *Invertebrates*, Sinauer Associates, Sunderland.
- BUCHANAN, P. 2005. *Renzo Piano Building Workshop, Vol 4*, Phaidon Press Inc, Hong Kong.
- BRONSVOORT W.F. and KLOK F. 1985, Ray Tracing Generalized Cylinders, *Transactions on graphics*, 4, No: 4, 291-303.
- CANDELA, F. 1960, *Reinforced Concrete Shells*. Student Publication of the School of Design.
- CALLADINE, C.R., 1983, *Theory of shell structures*. University Press. Cambridge.

- CHATTEJEE, B. K. 1988. *Theory and Design of Concrete Shells*. NY: Chapman & Hall, New York.
- CHIAT, M., 2004, *North American Churches*, Publications International, Ltd., New York.
- COOK, T. 1979. *The Curves of life*. Dover Publications, Inc. New York.
- CONKLIN, W. A. 1985. *Nature's Art: The Inner and Outer Dimensions of Shell*. University of Press, South Carolina.
- CORTIE, M. B. 1989. *Models for Mollusk Shell Shape*, *South African Journal of Science* , 85: 454-460.
- COX, J. 1979. *Shells Treasures from the Sea*. Larousse & Co., Inc. New York.
- DAWKINS, R. 1997. *Climbing Mount Improbable*. W. W. Norton & Company, New York.
- DENT, R. 1972. *Principles of Pneumatic Architecture*, Halsted Press Division John Wiley & Sons Inc: New York.
- DOORDAN, D., 2002. *Twentieth-century architecture* H.N. Abrams, New York.
- DREW, P. 1976. *Frei Otto-Form Structure*. Stuttgart: Verlag Gerd Hatje.
- ENGEL, H. 1997. *Structure Systems*. Verlag Gerd Hatje, Germany.
- FARIN, G., 2002. *Curves and surfaces for CAGD: a Practical Guide*. Morgan Kaufmann Publishers, San Francisco.
- FARSHAD, M. 1992. *Design and Analysis of Shell Structures*. Kluwer, Dordrecht.

- FISCHER, R. 1964. *Architectural Engineering: New Structures*. McGraw-Hill, New York.
- FOWLER, D. R. , P. MEINHARDT, and P. PRUSINKIEWICZ, 1992. Modeling Seashells, *Proceeding of SIGGRAPH'92*, [INTERNET ,WWW], ADDRESS: <http://www.cpsc.ucalgary.ca/Redirect/bmv/papers/sheels/sig92.pdf> [Accessed : 03 July 2003].
- FRAMPTON, K., 1996. *A Critical History Modern Architecture*, Thames&Hudson New York, USA.
- FRENCH, M. 1988. *Invention and Evolution: Design in Nature and Engineering*, Cambridge University Press, Cambridge.
- FRIEDRICHS, K. O. 1966. *From Pythagoras to Einstein*. Random House, New York.
- FRISCH, K. 1974. *Animal Architecture*. Harcourt Brace Jovanovich, New York.
- FORSTER, B. 1994 Cable and membrane roofs—a historical survey, *Structural Engineering Review*, no:6-3/4, 145–174.
- FOSTER and PARTNERS, 2005, “*Catalogue*”, Prestel, Berlin.
- GRIMSHAW, N. 1993. *Structure, Space and Skin : The work of Nicholas Grimshaw and Partners*. Phaidon. London.
- GORDON, N. R. 1990. *Seashells: A Photographic Celebration*. Friedman Group, New York.
- GÖNENÇ SORGUÇ, A. and ARSLAN SELÇUK, S. 2006, Yapay Zeka Araştırmaları ve Biomimesis Kavramlarının Günümüzde Mimarlık Alanındaki Uygulamaları: Akıllı Mekanlar”. 4. *Yapı ve Kentte Bilişim Kongresi*, Ankara.

- GÖSSEL, P. and LEUTHAUSER, G. 1991, *Architecture in the Twentieth Century*. Benedikt Tachen, Köln.
- GYORGY, D. 1981. *The Power of Limits: Proportional Harmonies in Nature, Art and Architecture*. Shambhala Publications Inc., U.S.
- HANSELL, M. 2005. *Animal Architecture Oxford Animal Biology Series*. Oxford University Press, New York.
- HARRIS, J. B., 1991. *Masted Structures in Architecture*, Butterworth Heinemann Ltd, Oxford.
- HARTOONIAN, G. 1994. *Ontology of Construction: on Nihilism of Technology in Theories of Modern Architecture*. Cambridge University Press, New York.
- HEINZ, T. A. 2000. *The vision of Frank Lloyd Wright*. Chartwell Books, Inc. New York.
- HERSEY, G., 1999. *The Monumental Impulse: Architecture's Biological Roots*, MIT Press. Cambridge.
- HERTEL, R. 1966. *Structure-Form-Movement*, Reinhold Publishing Corporation, New York.
- HERZOG, T. 1976. *Pneumatic Structure*, Oxford University Press, New York.
- HOLGATE, A. 1986. *The Art in Structural Design*, Clarendon Press, Oxford
- HUXTABLE A. L. 1965. *New Structures and Aesthetics and Technology in Building*. Harvard University Press, Cambridge.
- ILLERT, C. 1987. Part 1: Seashell Geometry, *Nuovo Cimento*, Vol. 9D, No.7: 792-813.

- ILLERT, C. 1989. Part 2: Tubular 3D Seashell Surfaces, *Nuovo Cimento*, Vol. 11D, No. 5: 761-780.
- ILLERT, C. 1995. *Foundations of Theoretical Conchology*. Hadronic Press, Inc., Florida.
- JENKS C. 1971. *Architecture 2000: Predictions and Methods*. International Thomson Publishing. London.
- JIRAPONG, K. 2002. *Discovering Architecture within a Seashell* Unpublished Ph.D. Thesis, The Graduate College of the Illinois Institute of Technology, Chicago, Illinois
- JONES, P., 2006, *Ove Arup: Masterbuilder of the Twentieth Century*. Yale University Press.
- KAWAGUCHI, Y. 1982. A morphological study of the form of nature. *Computer Graphics*, 16(3):223-232.
- KELKAR, V, S. 1987. *Fundamentals of the analysis and design of shell structures*. Englewood Cliffs, Prentice-Hall. N.J.
- KETCHUM, M. 1997. Types and forms of shell structures [INTERNET, WWW], ADDRESS: <http://ketchum.org/shells.html> [Accessed: 21 November 2006].
- Kim, Kyu Han, et al. 1999. Palaeoclimatic and Chronostratigraphic Interpretations From Strontium, Carbon and Oxygen Isotopic Ratios in Molluscan Fossils of Quaternary Seoguipo and Shinyangri Formations, Cheju Island, Korea. *Palaeogeography Palaeoclimatology Palaeoecology* 54: 219-235.
- KOCH, K., NEINHUIS, C., ENSIKAT, H. J. and W. BARTHLOTT, 2004. Self-assembly of epicuticular waxes on living plant surfaces imaged by atomic force microscopy (AFM). *Journal of Experimental Botany* 55(397): 1-8

- KOELMAN, O, 2002. *Biomimetic Buildings Understanding & Applying the Lessons of Nature*. [INTERNET, WWW], ADDRESS : <http://www.rmi.org/sitepages/art1048.php> [Accessed : 03 July 2003].
- KOELMAN, O. 2003. *Building the Future of Buildings*, [INTERNET, WWW], ADDRESS : <http://www.rmi.org/sitepages/art7520.php> [Accessed : 03 July 2003].
- KRONENBURG, R. 1996. *Portable Architecture*, Architectural Press
- LAMPUGNANI, V. M., (ed). 1988. *The Thames and Hudson Encyclopedia of 20th Century Architecture*, Thames and Hudson, London.
- MAINSTONE, R. J. 2001. *Developments in Structural Form*, Butterworth Heinemann Ltd, Oxford.
- MARGOLIUS, I. 2002. *Architects+ Engineers= Structures*. Wiley Academy Press, New York.
- MASSO, J, 1999. *Gaudi, The Man and His Work*, Little, Brown and Company, New York.
- MATTHECK, C. 1998. *Design in Nature. Learning from Trees*. Springer Verlag Berlin Heidelberg.
- MEINHARDT, H. 2003. *The Algorithmic Beauty of Sea Shells*. Springer, Verlag Berlin Heidelberg, Berlin.
- MELARAGNO, M.1991. *An Introduction to Shell Structures, and the Science of Vaulting*. Van Nostrand Reinhold, New York.
- MOORE. J. 2001. *An Introduction to the Invertebrates*. Cambridge University Press, Cambridge

- MURIEL, E., 1994, *Contemporary Architects*, St. Martin's Press, New York.
- MURPHY, K. D. 2000. *Memory and Modernity: Viollet-le-Duc*. University Park: Pennsylvania State University Press
- NOEL, K.F. 1978. *Patterns in Crystals*. Wiley. New York.
- OTTO, F. 1995. *Frei Otto, Bodo Rasch: Finding Form. Towards an Architecture of the Minimal*. Deutscher Werkbund Bayern. Berlin.
- PAPANEK, V. 1971. *Design for the Real World*, Random House, New York
- PEARSON, D. 2001. *New Organic Architecture the Breaking Wave*. University of California Press, Los Angeles.
- PEREZ G, A. 1979. *Introduction The Use of Geometry and Number in Architectural Theory: From Symbols to Reconciliation to Instruments of Technological Domination*. West Yorkshire. Essex.
- PIANO, R. 1989. *Renzo Piano and Building Workshop: Buildings and Projects, 1971-1989*, Rizolli. New York.
- PICKOVER, C. 1989. A Short Recipe for Seashell Synthesis. *IEEE Computer Graphics and Applications* IEEE Computer Society Press Los Alamitos, CA, USA. Volume 9 , Issue 6: 8–11.
- PORTOGHESI, P. 2000. *Nature and Architecture*, translated by Erika G. Young, Skira, Milan.
- RAUP, D. M.1961. The Geometry of Coiling in Gastropods , *Proceedings of the National Academy of Sciences of the United States of America*, Volume 47: 602–609.

- RAUP, D. M. 1962. Computer as Aid in Describing Form in Gastropod Shells, *Science*, July -September. Watson-Guption Publications, 138:150-152.
- RAUP, D. M. and MICHELSON, A. 1965. Theoretical morphology of the coiled shell. *Science*, 147:1294-1295,
- RAUP, D. M. 1966. Geometric analysis of shell coiling: general problems. *Journal of Paleontology*, Vol 40: 1178-90.
- RAUP, D. M. 1969. Modeling and simulation of morphology by computer. *Proceedings of the North American Paleontology Convention*, 71-83.
- ROBBIN T., 1996. *Engineering a New Architecture*, Yale University Press, London.
- ROBBINS, J. 2001. *Engineers Ask Nature For Design Advice*, [INTERNET, WWW], ADDRESS:(<http://www.arn.org/docs2/news/engineersasknature121201.htm>) [Accessed : 03 July 2003].
- ROGERS, D.F., 2001, *An introduction to NURBS with historical perspective*. Morgan Kaufmann Publishers, Berlin.
- ROLAND, C.1970. *Frei Otto Tension Structure*, Praeger Publisher, New York.
- ROMÁN, A. 2003. *Eero Saarinen: an Architecture of Multiplicity*, Princeton Architectural Press, New Jersey.
- RUPPERT, E., BARNES, R. 1994, *Invertebrate Zoology*, Harcourt Brace College Publishers
- RUSSELL- HUNTER, W.D., 1970. *Biology of Lower Invertebrates, the Macmillan Co.*
- SALVADORI, M, G. 1972. *Structural Design in Architecture*. Prentice Hall, New York

- SALVADORI, M, G. 1982. *Why Buildings Stand up: the Strength of Architecture*. McGraw-Hill, New York.
- SEGGERN, D, H. 1990. *CRC Handbook of Mathematical Curves and Surfaces*. CRC Press, New York.
- SENOSIAIN, J. 2003. *Bio-Architecture* Architectural Press, Oxford.
- SHARP D., 1991. *The Illustrated Encyclopedia of Architects and Architecture*, Quatro Publishing. New York.
- SHARP, D., 1972, *A visual history of twentieth-century architecture*. Greenwich, New York.
- SHARP, D. 1994. *Santiago Calatrava*, E & FN Spon, London.
- SHEAR W.A., J.M. Palmer, J.A. CODDINGTON, and P.M. BONAMO. 1989. A devonian spinneret: early evidence of spiders and silk use. *Science*, 246, 479-481.
- STANLEY, S, M. 1970. *Relation of shell form to life habits of the Bivalvia (Mollusca)* Geological Society of America, Boulder, Colombia.
- THOMPSON, W D. 1992. *On growth and form*. University Press, Cambridge.
- TOPHAM, S. 2002. *Blow Up*. Prestel - Verlag, Munich.
- TZONIS, A. 1999. *Santiago Calatrava, The poetics of Movement*. Universe Publishing. New York.
- VERMEIJ, G, J. 1993. *A Natural History of Shells*. Princeton University Press, New Jersey.

- VINCENT, J.F.V. 1995 Borrowing the best from Nature . (from Vincent archive) In Encyclopaedia Britannica Yearbook.
- VITRUVIUS. 1998. *Mimarlık üzerine on kitap - The ten books on architecture*, translated by Morris Hicky Morgan; Türkçe çevirisi Suna Güven. Şevki Vanlı Mimarlık Vakfı yayınları, İstanbul.
- VOGEL, S. 1998. *Cats' Paws and Catapults. Mechanical Worlds of Nature and People*. Penguin Books, London.
- von GERKAN, M. and MARG, V. 2007 „ von Gerkan Marg und Partner Buildings“ Prestel, Berlin.
- WILKINSON, C., 1996. *Supersheds, The Architecture of Long-Span, Large-Volume Buildings*, Butterworth_Heinemann Ltd, Oxford.
- WILLIAMS, C.J.K., 2000, The Definition of Curved Geometry for Widespan Enclosures, Proceedings of the International Symposium on Widespan Enclosures, University of Bath, UK.
- WILLIAMS, H.A. 2003. *Zoomorphic-New Animal Architecture*, Laurence King Publishing Ltd., New York.
- ZANNOS, A. 1987. *Form and Structure in Architecture - The Role of Statical Function*. Van Nostrand Reinhold Company, New York.
- ZARDINI, M. 1996. *Santiago Calatrava Secret Sketchbook*, Monacelli Press, New York.
- ZINGONI, A. 1997. *Shell Structures in Civil and Mechanical Engineering*. Thomas Telford, London.
- ZUK, W. 1970. *Kinetic Architecture*, Van Nostrand Reinhold, New York.

APPENDIX A

SEASHELLS AND TERMINOLOGY OF CONCHOLOGY

As a general explanation, seashells are the exterior skeletons (exoskeletons) of a group of animals called "mollusks". The word "mollusk" means "soft-bodied;" an exterior skeleton is very important to these creatures, providing them with shape and rigidity, and also with protection, and sometimes camouflage, from predators (Abbott, 1954). The following are specific terms generally used in the study of seashell in biology and zoology and cited from Cox, 1979.

Conchology (*concha means "shell" in Latin.*) It is the term for a science dealing with the external skeleton of the animal inside.

Mollusca (*mollis means "soft" in Latin.*) French naturalist, Georges Cuvier, had proposed this name for the boneless creatures. The name in English is mollusc or mollusk.

Hersey (1999:42) claims that, in the type of shells phylum Mollusca must be concerned as the commonest one in nature. Scientists estimate there are 80,000-100,000 species of mollusks. Shells, which provide protection for these invertebrate animals, are the supporting systems of the structures of this phylum. Mollusks have soft bodies containing internal organs. Many species have a muscular foot and some species have a head with tentacle and eyes, says Brusca (2003: 703-720). He continues to say that mollusks have some species resemble each other, are capable of interbreeding, but may differ slightly in size, shell shape and color.

Ruppert and Barnes (1994) states that, shells are primarily made of the mineral calcium carbonate, a salt present in the blood of mollusks, obtained either from the food they eat or water they live in. The one feature unique of all mollusks is the presence of a "mantle". The mantle is a lobe, pair of lobes, or fold of muscular flesh

containing specialized glands. The glands convert the salt in the blood to a liquid form of calcium carbonate. Cells at the edge of the mantle secrete this liquid. It solidifies, forming more shell. As mollusks grow larger and additional shell is required for support, another layer of calcium carbonate is spread onto the lip of the shell. Since the thickness of each layer is slightly different, this starting and stopping of the growth process forms “growth lines” (Ruppert and Barnes, 1994).

According to Russell and Hunter, many species of mollusks found in warmer waters have shells more colorful than found farther north because the southern occurring mollusks have more nutrients available to them. The organic pigments contained in the nutrients are processed by the mollusk, distributed by the blood system, and then mixed with the liquid calcium just before the shells harden. A colorful shell is produced. The colors and patterns of each species are inherited although there is some natural variation. Environment and diet also influence the coloration of shells within species (Russell- Hunter, 1970),

In general, the two types of shells commonly found are **bivalves**, mollusks with two shells hinged together, and **univalves**, mollusks having a single shell. The “valves” by the way, actual shells, so called because they control the inflow of food and outflow of waste (Stanley, 1970). Actually, scientists have developed a process of classification in which all living creatures are organized into systems of groups, generally based on common properties. According to their many anatomical variations, the mollusks have been divided into **5 main classes**. The four most common classes of mollusks are **chitons**, **tusks**, **bivalves** and **gastropods**, interestingly, **octopus** and **squid** are mollusks too, but have no external shell (Stanley, 1970).

a) Class Polyplacophora (Amphineura) – the chitons are little armored tanks, with a row of eight overlapping plates protecting them (Figure 5.11).

b) Class Scaphopoda – the tooth and tusk shells also have a single shell, but it does not coil at all; it grows in a narrow and very slightly curved cone shape (Figure 5.11).



Figure A.1 Representative examples of chiton and tusk shell (Source: Gordon, 1990)



Figure A.2 Representative examples of bivalve and chambered nautilus (Source: Gordon, 1990)

c) Class Bivalvia – clams, oysters, mussels, scallops, cockles, shipworms, inhabit oceans, brackish water and fresh water. The two shells of bivalve are generally mirror images of one another, joined by an elastic ligament or hinge. When the animal dies and decays and only the shell are left, the two valves usually break apart at the hinge. (Figure 5.12)

d) Class Cephalopoda – chambered nautilus, octopi, squids and cuttlefishes contains about 200 extant species and they range in size from a few centimeters to

the giant squid over 20 meters in length and weighing over 250 kg, living inside, the largest invertebrate (Figure 5.12)

e) Class Gastropoda – snails, slugs, limpets, whelks, conchs, periwinkles

frequently found are the snail and whelk. Gastropods (gastro means stomach and pod means foot) live in fresh and salt water and some species live on land. In most cases, their single shell has a spiral appearance consisting of a coiled tube, increasing in size as it winds around a central axis. This mollusk uses a foot to move along a floor of its habitat. Many varieties of these single shell mollusks eat bivalves. Depending on species, they retrieve their meal by either forcing the bivalves apart with their foot or by drilling into the bivalve's shell (Figure 5.13). Gastropods are the most diverse group of mollusks, with an estimated 24,000 land, 40,000 marine and 3,000 freshwater species.²⁵



Figure A.3 Some representative examples from Class Gastropoda

According to Vermeij, the primary function of the gastropod's shell is the protection and they build their shells according to a few basic principles that relate to growth and form by secretions of the mantle glands that control its growth (Vermeij, 1993). However, Senosiain (2003: 48) can not reveal his bewilderment and goes on to say that, it is surprising how mollusc, being so soft, can create such hard, resistant

²⁵ THE SHELL MAKERS: Gastropods, <http://www.arches.uga.edu/~amlyne/GSC/gastropoda.html> accessed on Nov2005

structure. The structure grows and is enlarged gradually, consolidating itself progressively from inside.

When the internal structure of the shell is considered it can be observed by slicing the shell through its vertical axis. The section is a continuous tube coiled with an imaginary axis which is indicating the shell growth starting from the childhood of the animal (Dawkins, 1997: 199). At first glance, overlapping whorls and the columella with its ribs inside the shell seems like helping to increase the overall stiffness of the shell structure. Cox (1979) asserts that in some shells the coiled tube gets tightly around the axis and forms an elongated cone called the columella, attached by the muscles that permit a mollusk to withdraw all its soft part into the shell. Although some mollusks cease to grow after reaching sexual maturity, most continue to grow throughout their lives. Size is not an indicator of age, however, many other factors, including water temperature, type and quantity of food available, affect the rate of shell growth (Vermeij, 1993) as mentioned before.

APPENDIX B

BIOLOGY and ARCHITECTURE

Table B.1 Timeline representing developments in biology and architecture

<p>First domesticated animals: 9000 BC</p> <p>Aristotle's <i>Historia Animalium</i> c. 340 BC</p> <p>Pliny the Elder's <i>Natural History</i> c. 70 AD</p> <p>Medieval bestiaries 400s-1100s</p> <p>Leeuwenhoek observes many micro organisms for the first time using optical equipment of his own invention, bringing knowledge of the great diversity of life 1674</p> <p>Amateur naturalism flourishes 1740s</p> <p>Buffon's <i>Histoire Naturelle</i> presents many animal species specimens kept in the Jardin du Roi in Paris 1749</p> <p>Cari Linne, Linnaeus, makes zoological additions to his <i>Systema Naturae</i> using the system of binomial nomenclature for the classification of species that survives to this day 1758</p> <p>Comparative anatomical studies lead Cuvier to group the animal kingdom into 'four prototypical phyla, destroying previous notions of a linear chain of being' 1812</p> <p>Western zoos and botanical gardens flourish, bringing many exotic species to the public gaze for the first time 1820s</p> <p>Dinosaur remains first uncovered 1824</p> <p>Audubon's <i>Birds of America</i> 1827-38</p> <p>Boer's studies refute the idea that the development of an embryo of a species is in any way a sped-up version of evolution of that species</p> <p>ontogeny does not recapitulate phylogeny 1828</p> <p>Kosmos presents Humboldt's vision of a globally connected environment, the summation of his expeditions begun 50 years previously 1849</p> <p>Darwin publishes <i>On the Origin of Species</i> 1859</p> <p>Thoreau celebrates the return to nature 1840s</p> <p>Morphology is used as the key to evolutionary history until mounting palaeontological evidence proves more informative 1850s</p> <p>Herbert Spencer asserts that society can be regarded analogously to a biological organism and draws parallels between social and biological evolution 1860s</p> <p>Early efforts at conservation; first nature reserves 1860s</p> <p>HMS Challenger returns from voyages of exploration with many marine specimens never before seen 1876</p> <p>The term 'ecology' originally coined by Haeckel in 1866, is taken up at scientific conferences 1893</p> <p>De Vries lays the basis for modern gene theory, relying in part on renewed interest in Mendel's neglected work on hybridization 1900</p> <p>Haeckel at Jena publishes <i>Kunstformen der Natur</i>, beautifully illustrating many unfamiliar species, especially marine fauna 1904</p> <p>Darcy Thompson publishes <i>On Growth and Form</i>, memorably comparing the Forth Rail Bridge with the skeleton of a bison, and stating that form, whether natural or manmade, is a diagram of forces 1917</p> <p>Watson and Crick elucidate the structure of DNA 1953</p> <p>Rachel Carson's <i>Silent Spring</i> catalogues humankind's depredations of the environment 1962</p> <p>Palaeontologist David Raup uses a computer to generate a rich diversity of shell forms 1966</p> <p>James Lovelock publishes papers outlining the Gaia hypothesis that the earth is a system that regulates itself in order to maintain life 1972</p> <p>The Club of Rome publishes <i>Limits to Growth</i> 1972</p> <p>Oil crisis; environ- mental conscious- ness increases 1973</p> <p>Edward O. Wilson publishes <i>Sociobiology</i> proposing that the social instinct is the product of evolutionary adaptation, and so providing a evolutionary explanation for those who wish to make architecture more biological 1975</p> <p>Richard Dawkins, <i>The Selfish Gene</i> 1976</p> <p>Green consumer' movement 1989</p>	<p>1.75m years BC Earliest known mammal shelter at Kenya</p> <p>30,000 BC Earliest known cave art France</p> <p>8500 BC Saharan rock art depicting animals</p> <p>8000 BC+ Palaeolithic dwellings use animal skins and sometimes bones for structure. A shelter uncovered in the Ukraine was found to comprise 385 mammoth bones</p> <p>2500 BC Sphinx, Giza, Egypt</p> <p>1200s Gothic style, gargoyles</p> <p>1438 The Inca capital Cuzco, Peru, is replanned in the shape of a puma, with the fortress-temple of Sacsayhuaman at the head</p> <p>1500a Renaissance monster park, Bomarzo, Lazio, Italy</p> <p>1680s The spire of the Church of Our Saviour, Copenhagen, resembles a spiral shell</p> <p>1770s Structural iron-work expands; the British tend to favour cast iron, the French wrought iron</p> <p>late 1700s Jean-Jacques Lequeu designs a dairy in the form of a cow</p> <p>1800s The town plan of Musumba in Congo takes the form of a turtle, possibly because of the defensive function of its shell</p> <p>1805 Jean-Nicolas-Louis Durand catalogues building form, type and function</p> <p>1830s Frederick Law Olmsted, urban parks</p> <p>1854 Viollet-le-Duc begins to publish theoretical works which revive Gothic architectural ideals using steel and other modern materials</p> <p>1855 Mild steel begins to be made using Bessemer's process</p> <p>1883 Lucy the Elephant at Margate, New Jersey, a patented design by James Laffery, is the first of many American vernacular structures in the shape of animals</p> <p>1884 Gaudi, already designing the extravagant buildings of the Park Güell, receives the commission for his life's work, the church of Sagrada Família</p> <p>1899-1904 Gustave Gulland, Paris, Metro entrances</p> <p>1909 Berge's St Hubertus hunting lodge near Arnhem has a plan based on deer antlers</p> <p>1910 First paper airplane structures, FW Lancheiter</p> <p>1912 Paul Jurca, Pioneer of Czech cubism at Dornach, Switzerland,</p> <p>1913 Rudolf Steiner builds the Goethehaus at Dornach, Switzerland, to promote his theory of anthroposophy; building elements suggest human organs</p> <p>1914 Bruno Taut designs the Glass Pavilion for the Werkbund exhibition at Cologne</p> <p>1921 Mendelssohn's Einstein Tower, Potsdam</p> <p>1920s Eileen Gray's circular studio</p> <p>1930s American 'billboard architecture' makes abundant use of animal motifs</p> <p>1939 Frank Lloyd Wright, Johnson Wax building, Racine, Wisconsin in architecture-explores lightweight structures inspired by zoology</p> <p>1940 Engineer Koberle Kicolas promotes the use of space frames</p> <p>1943 Wright begins work on the Guggenheim Museum</p> <p>1947 Aalto's Baker House dormitory at the Massachusetts Institute of Technology is dubbed by students the "pregnant worm"</p> <p>1948 Pier Luigi Nervi's Turin Exhibition Hall; along with Ove Arup and Felix Candela, Nervi represents a new breed of engineer interested in expressive form</p> <p>1950-55 Le Corbusier, Ronchamp Chapel</p> <p>1950s Frederick Kiesler's 'house as organ-ism'; architects and engineers explore the expressionist possibilities of concrete technology improved during the Second World War</p> <p>1955 Bull's horns are among the visual devices encoded in Le Corbusier's government build-ings at Chandigarh</p> <p>1957s Utzon, Sydney Opera House begun</p> <p>1958 Eero Saarinen, Ingalls hockey rink, New Haven, Connecticut</p> <p>1960 Lucio Costa's city plan of Brasilia resembles a bird in flight</p> <p>1960s Buckminster Fuller, Geodesic Domes</p> <p>1961 Herb Greene, Prairie House, Norman, Oklahoma</p> <p>1960s Proliferation of tensile and light-weight structures</p> <p>Haus-Rucker-Cos's Pneumacism cascades bubble-like dwelling units down a skyscraper while Yellow Hear is a pneumatic love-nest; Coop Himmelblaus's Cloud projects</p> <p>1962 Eero Saarinen, TWA Terminal, New York</p> <p>1964 Kenzo Tange, Tokyo Olympic stadiums</p> <p>1964 Archigram: Ron Herron's Walking City and David Greene's Living Pod are among the group's animalistic projects</p> <p>1965 Hugh Casson, Elephant House, London Zoo</p> <p>1967 Nicholas Grimshaw's first built project is a theatrical addition to the Anglican International Students' Club in London. Wash-rooms are easily accessed off a spiral staircase arranged not unlike the functional elements of a mollusc's mantle</p> <p>1968 Roger Vidim's coll film <i>Barbarella</i> provides key images for architects of soft form</p> <p>1972 Frei Otto's Munich Olympic Stadium shows the potential of tensile membrane structures long before there are computers available to do the structural calculations</p> <p>1972s Niki de Saint Phalle, Neillens house, Knokke, Belgium</p> <p>1973s Habiter la Mer, sea surface and undersea projects</p> <p>1975 Foster Associates Willis Faber and Dumas offices, have an amoeba-like plan and a turf roof</p> <p>1980s CAD use increases rapidly</p> <p>1981 Gehry's fish motif first appears</p> <p>1984 Future Systems' projects begin to adopt more animalistic forms</p> <p>1989 John Frazer and the Architectural Association's Diploma Unit 11 investigate the 'evolutionary' generation of form</p>
---	--

CURRICULUM VITAE

PERSONEL INFORMATION

Sumame, Name: Arslan Selçuk, Semra
Phone: +90 312 210 22 03
Fax: +90 312 210 79 66
email: semra@arch.metu.edu.tr, semraarslan@yahoo.com

EDUCATION

Degree	Institution	Year of Graduation
BS	Selçuk University, Dept. of Arch. 1 st Rank (3.82/4)	1999

WORK EXPERIENCE

Year	Place	Enrollment
2002- 2009	METU, Architecture Department	Research Assistant
2001-2002	ARSEL Architects	Project Manager
1999-2001	KARAASLAN Architects	Architect
1998 (3 Months)	YAYCIOĞLU Architect	Intern
1997 (3 Months)	BİLGİN Construction Corp.	Intern

FOREIGN LANGUAGE

English (KPSD: 85/100, ÜDS: 91.25/100)

EXPERIENCES

Visiting Researcher

-Research collaboration with Dr. Chris Williams, University of Bath, England (June-September 2005)

Teaching Experiences

-Research Assistant of the following courses in Dept. of Architecture, METU
-What Gets Buildings Made (Arch 351)
-Acoustical Design of Halls for Musical Performance (Arch 479)
-Mathematics in Architecture (Arch 333)
-Digital Design Studio (Arch 470)
-Advanced Digital Design Studio (Arch 475)

Architectural Experiences

ARSEL ARCHITECTS (SEMRA ARSLAN SELÇUK -MUSTAFA SELÇUK)

-Culture and Convention Hall for Sapanca Municipality
-Shopping Center for Sapanca Municipality
-Market Place for Sapanca Municipality
-Sakarya Park Hotel for Osman Hamdi, Sakarya
-6 pedestrian bridge projects, Ankara

KARAASLAN ARCHITECTS (MERİH KARAASLAN)

-Osmaniye Government Office, Osmaniye
-Osmaniye State Hospital, Osmaniye
-Rize University Campus Planning and Buildings, Rize

- Rize State Hospital, Rize
- Kırıkkale Region Hospital and Emergency Room
- Ankara Bilkent Terrace Houses
- Additional Building for Arinna Hotel, Antalya
- Elazığ Harput Urban Design Project
- Şefik Gül Villa Reconstruction Project, Ankara
- Competition of Service Building for Ankara Big City Municipality, Ankara
- Merih Karaaslan "Yapıtlar Anılar-2" (Buildings and Memories- 2)

WORKSITE INTERNSHIP at BILGIN Construction Corp.

- Environmental Control Laboratories for the Ministry of Environment, Gölbaşı
- Vehbi Bilgin Villa, Bilkent
- Headquarters Building for Bilgin Construction Corp., G.O.P

BUREAU INTERNSHIP at YAYCIOĞLU ARCHITECTS (M.ARCH HAYDAR YAYCIOĞLU)

- Mareşal Fevzi Çakmak Military Hospital, Erzurum
- Headquarters Building for Ministry of National Defense, Ankara
- Reconstruction Projects for Dining hall of Ministry of National Defense, Ankara
- Guest House for Ministry of National Defense, Ankara

COMPUTER EXPERIENCE

- CAD Packages : AutoCAD, 3DMAX, Odeon, SAP2000, CATIA
- Graphic Packages : Adobe Photoshop, PageMaker, Macromedia Dream Weaver, Corel Draw
- Office Packages : Microsoft Packages

PUBLICATION

Journal Papers

-Arslan S., Gönenç Sorguç A., "Mimari Tasarım Paradigmasında Biomimesis'in Etkisi", Gazi Mimarlık Mühendislik Fakültesi Dergisi (Indexed in Ei/Compendex), Vol.22, No.2 pp.451-460, Haziran 2007.

Chapter in a Book

-Arslan, S., Gönenç Sorguç, "Biomimesis in Architecture: Inspiration for Next Generation Po(r)table Buildings" Transportable Environments III Book March 2005 pp. 189-191.

International Conferences Papers

-Arslan, S., Gönenç Sorguç, A. "Similarities in Structures in Nature and Man-Made Structures : Biomimesis in Architecture" 2nd Design and Nature Conference Comparing Design in Nature with Science and Engineering, Rhodes, Greece, June 28-230, 2004 (This paper awarded with Young Researchers Scholarship conferred by Office Naval Research Global [ONRG] and Wessex Institute of Technology)

-Arslan, S., Çalışkan, M. "Bilgisayar Benzetimi Yoluyla Res toranlarda Gürültü Denetimi" 10th International Ergonomics Congress, Bursa, Türkiye, October 7-9, 2004

-Arslan, S., Dikmen, N. "Açık Ofis Tasarımında Gürültü Denetimi ve ODTÜ Mimarlık Fakültesi ÖYP Araştırma Görevlileri Açık Ofis Örneği" 10th International Ergonomics Congress, Bursa, Türkiye, October 7-9, 2004

-Çalışkan, M. Arslan, S., "Acoustics Education for Sustainable Buildings: ME TU Experience". International Conference on Sustainable Building South East Asia, Kuala Lumpur, Malaysia, 11-13 April 2005,

-Arslan, S., Kumkale E. "Biomimesis: Architectural Inspiration for the Future" 5th International Postgraduate Research Conference in the Built and Human Environment, University of Salford, UK, 11 – 15 April 2005

-Kumkale, E., Arslan, S., "Lifestyles And The Use Of Technology In The In-City, High-Rise Residential Developments Of Istanbul" 5th International Postgraduate Research Conference in the Built and Human Environment, University of Salford, UK, 11 – 15 April 2005.

-Arslan Selçuk, S., Er Akan A., Ünay A.I., "Exploration of Structural Chaos and Anarchy in Sinan's Domed Structures" The 8th Conference "Shell Structures: Theory and Applications" Gdansk-Jurata, Poland, 12-14 October 2005.

-Arslan Selçuk, S., Fisher A., Williams C., "Biomimesis and the Geometric Definition of Shell Structures in Architecture" 8th Generative Art Conference, Italy, Milan, December 2005,

-Er Akan, A., Arslan Selçuk, S., Çakıcı, F. Z., "Antalya'daki Kırkgöz Han'ın Sonlu Elemanlar Yöntemi ile Deprem Analizi" ACE 2006 7th International Congress on Advances in Civil Engineering, 11-13 October 2006.

International Conferences Poster Presentations

-Arslan, S., Gönenç Sorguç, A. "Biomimesis in Architecture: Inspiration for Next Generation Portable Buildings" Poster presented and published in the Proceedings of the 3rd Design at the International Conference 2004 Transportable Environments III Toronto, Canada, April 28-30, 2004.

-Arslan Selçuk, S "Mathematics as a Tool to Evaluate Biomimetic Inspirations: a Study on Seashell Modeling" 1st International CIB Endorsed METU Postgraduate Conference on Built Environment and Information Technologies, Ankara, Türkiye, March 16-18 2006.

National Conference Papers

-Arslan, S., Sü, Z. Çalışkan, M. "Mimarî Akustik Eğitiminde Bilgisayar Benzetiminin Tasarım Sürecine Katkısı: 500 Kişilik Konser Salonu Örneği" 7. Ulusal Akustik Kongresi, Kapodakya, 17-19 Kasım, 2004.

-Arslan Selçuk, S., Er Akan, A., "Bir Şehir İkonu Olma Yolunda Yaya Üst Geçitleri ve Aydınlatmaları: ODTU Yaya Üst Geçiti Örneği" 3.Ulusal Aydınlatma Sempozyumu, Ankara, 23-25 Kasım 2005.

-Er Akan, A., Arslan Selçuk, S., "Ofislerin Aydınlatmaları Üzerine Bir İnceleme: A Tasarım Mimarlık Ofisi Örneği" 3.Ulusal Aydınlatma Sempozyumu, Ankara, 23-25 Kasım 2005.

-Arslan Selçuk, S., Er Akan, A. "Mimarî Tasarımın Deprem Dayanımına Etkisi: Antalya TED Koleji'nin Deprem Yönetmeliğine Göre İncelenmesi" Antalya Yöresinin İnşaat Sorunları Kongresi, Antalya, 22-24 Eylül 2005.

-Er Akan, A., Arslan Selçuk, S., Çakıcı, F. Z., "Kültür Turizmi Açısından Kırkgöz Han'ın Yeniden İşlevlendirilmesi Olanakları Üzerine Bir Çalışma" Turizm ve Mimarlık Sempozyumu, Antalya, 28-29 Nisan 2006.

-Gönenç Sorguç, A., Arslan Selçuk, S. "Yapay Zeka Araştırmaları ve Biomimesis Kavramlarının Günümüzde Mimarlık Alanındaki Uygulamaları: Akıllı Mekanlar" 4.Yapı ve Kentte Bilişim Kongresi, Ankara, 8-9 Haziran 2006,

-Arslan Selçuk, S., Gönenç Sorguç A., "Ekolojik Mimarlık Çalışmalarında Doğanın En İyi Fikirlerinden Öğrenmek", Ekolojik Mimarlık ve Planlama Sempozyumu, Antalya. 27-28 Nisan 2007.

-Arslan Selçuk, S., Gönenç Sorguç, A., "Akademik Etik ve Bir Fikir Yarışmasının Ardından Düşünceler" 2. Genç Mimarlar Buluşması, Antalya, 19 Mayıs 2007 (Davetli Konuşmacı)

-Dikmen, N., Arslan Selçuk, S. "Geleneksel Anadolu Konutunda Depolama Alanı Olarak Kullanılan Seki Altı Dolapların Günümüz Apartman Konutundaki Karşılıklarının İncelenmesi" 15. Yıl Mühendislik-Mimarlık Sempozyumu, Isparta, 14-16 Ekim 2007.

National Conference Poster Presentations

-Örmeciöğlü, T., Arslan Selçuk, S., "Erken Cumhuriyet Döneminde Betonarme Teknolojisi: Ankara Stadyum ve Hipodrom Yapıları" Poster Sunuşları Türkiye Mimarlığında Modernizmin Yerel Açılımları II Ahmet Piriştina Kent Arşivi ve Müzesi-İzmir, 11-12 Kasım 2005.

-Sönmez F., Arslan Selçuk, S "Modernizmin Kayseri Apartman Kültüründeki İzleri: Sicimoğlu Evi" Poster Sunuşları Türkiye Mimarlığında Modernizmin Yerel Açılımları II Ahmet Piriştina Kent Arşivi ve Müzesi-İzmir, 11-12 Kasım 2005.

-Sönmez F., Arslan Selçuk, S., "Organik Mimarlığın Türkiye'deki Örneklerinden Biri: Özkanlar Evi" DOCOMOMO_Türkiye Ulusal Çalışma Grubu Poster Sunuşları Türkiye Mimarlığında Modernizmin Yerel Açılımları III, Erciyes Üniversitesi Mimarlık Fakültesi, Kayseri, 2-4 Kasım 2007.

Paper Published in WebPages

-Arslan, S., Gönenç Sorguç, A. "Akademik Etik ve Bir Fikir Yarışmasının Ardından Düşünceler" 18 Haziran 2007 http://www.arkitera.com/haber_17632_akademik-etik-ve-bir-fikir-yarismasinin-ardindan-dusunceler.html

-Arslan, S., Gönenç Sorguç, A. "Mimarlıkta Doğanın En İyi Fikirlerinden Öğrenmek" (Arkitera Ekim 2008 Gündem Dosyası Biomimicry İçin Davetli Yazı) <http://www.arkitera.com/g146-biomimicry.html?year=&aID=2677>

Conference Organization

-Organizing Committee Member of 1st International CIB Endorsed METU Postgraduate Conference on Built Environment and Information Technologies METU-Ankara, Türkiye March, 2006.

Seminar Given

-Seminar on "Biomimesis in Architecture", Biomimetic Center, University of Bath August 01, 2005.

Workshop

-Participant of 1st International DOCOMOMO Workshop Ataköy İstanbul, Türkiye, September 18-26 2006. (IX. Uluslararası DOCOMOMO Konferansı "Öteki" Modernizmler kapsamında 1.Uluslararası DOCOMOMO Çalıştayı, "Bir Konut Ütopyasının Korunması: Modern Mimarlık Mirasının Belgelemesi ve Sürekliliğinin Sağlanması, Örnek Çalışma: Ataköy- İstanbul")

Award

-PhD research was awarded with "İz Bırakanlar" Scholarship by Türkiye Çimento Müstahsilleri Birliği for 2 years (2005-2007)

Research Projects Involved

-"Biomimesis Kavramıyla Mimarlıkta Yeni Nesil Teknoloji Hafif Taşıyıcı Sistemlerin Araştırılması", ÖYP Projesinde araştırmacı 2004-2009

-"Mimarlık Fakültesi Bilişim Alt Yapısını Destekleme Projesi", BAP 2005-02-01-04 no'lu Projede araştırmacı

-"Türk Yapı Sektörü'nün Avrupa Birliği Ülkelerindeki Yapı Sektörleri ile Karşılaştırılması ve Avrupa Birliği Uyum Sürecinde Sektörün Entegrasyonu için Model Geliştirilmesi", BAP-2007-02-01-02 Projesinde araştırmacı