

COMPARISON OF 2002 AND 2004 ELEMENTARY SCIENCE
CURRICULA WITH RESPECT TO COGNITIVE AND AFFECTIVE
CHARACTERISTICS OF STUDENTS

A THESIS SUBMITTED TO
THE GRADUATE SCHOOL OF NATURAL AND APPLIED SCIENCES
OF
MIDDLE EAST TECHNICAL UNIVERSITY

BY

AKİF ORUÇ

IN PARTIAL FULFILLMENT OF THE REQUIREMENTS
FOR
THE DEGREE OF MASTER OF SCIENCE
IN
SECONDARY SCIENCE AND MATHEMATICS EDUCATION

JUNE 2009

Approval of the thesis:

**COMPARISON OF 2002 AND 2004 ELEMENTARY SCIENCE
CURRICULA WITH RESPECT TO COGNITIVE AND AFFECTIVE
CHARACTERISTICS OF STUDENTS**

submitted by **AKİF ORUÇ** in partial fulfillment of the requirements for the degree of **Master of Science in Secondary Science and Mathematics Education Dept, Middle East Technical University** by,

Prof. Dr. Canan Özgen
Dean, Graduate School of **Natural and Applied Sciences** _____

Prof. Dr. Ömer Geban
Head of Department, **Secondary Science and Mathematics Education** _____

Prof. Dr. Giray Berberoğlu
Supervisor, **Secondary Science and Mathematics Education Dept.** _____

Examining Committee Members:

Doç.Dr. Nükhet Ç. Demirtaşlı
Measurement and Evaluation Dept., Ankara University _____

Prof. Dr. Giray Berberoğlu
Secondary Science and Mathematics Education Dept.,
METU _____

Assist. Prof. Dr. Yezdan Boz
Secondary Science and Mathematics Education Dept.,
METU _____

Assoc.Prof.Dr. Ceren Tekkaya
Elementary Science Education Dept., METU _____

Assoc.Prof.Dr. Özgül Yılmaz Tüzün
Elementary Science Education Dept., METU _____

Date: **17.06.2009**

I hereby declare that all information in this document has been obtained and presented in accordance with academic rules and ethical conducts. I also declare that, as required by these rules and conduct, I have fully cited and referenced all material and results that are not original to this work.

Name, Last Name: AKİF ORUÇ

Signature:

ABSTRACT

COMPARISON OF 2002 AND 2004 ELEMENTARY SCIENCE CURRICULA WITH RESPECT TO COGNITIVE AND AFFECTIVE CHARACTERISTICS OF STUDENTS

Oruç, Akif

M.S., Department of Secondary Science and Mathematics Education

Supervisor: Prof. Dr. Giray Berberoğlu

June 2009, 116 pages

The purpose of this study is to investigate the effect of 2004 elementary science and technology curricula at grade level 7. For this purpose, the effect of 2004 curricula on the (1) achievement of the students in knowledge, conceptual understanding and higher order thinking skills clusters, (2) attitude toward science and technology, (3) teachers' classroom activities were evaluated.

This study was conducted on 290 7th grade students at six elementary schools in 2006-2007 spring term. These schools were located in Sincan, Yenimahalle and Mamak in Ankara. Two schools were administering 2004 curricula as pilot group and four of them were teaching science with 2002 curricula. Grade level 7 was selected for the study since both 2002 and

2004 curricula were being implemented in the schools only at this particular grade level.

The achievement test questions were selected from TIMSS science achievement tests and the researcher's own questions written in line with the test plan. The questions include the common objectives of both 2002 and 2004 curricula. The Test of Science Related Attitudes was developed by Chaerul (2002). As a result of the factor analysis it was decided that, the scale contains five sub categories: Social implication of science, Scientist lifestyle, Enjoyment of learning in science lesson, Leisure interest in science, and Career interest in science. Teachers' Classroom Activities Scale was taken from Pekiner (2007). It was decided that, the scale contains five sub categories; New Approach, Care of Teacher, Use of Equipment by teachers, Classical Classroom Activities and Processing the Subject category.

The data were analyzed by using multivariate analysis of variance (MANOVA). The results of this analyses indicated no major difference between two science curricula. On the other hand, significant differences were found in leisure interest of students and use of equipment by teachers in favor of 2004 curricula. Knowledge and conceptual understanding level learning, the enjoyment of learning in science lesson and teachers' classroom activities with reference to new approaches indicated significant results in favor of 2002 curricula.

Keywords: Curriculum development, science achievement, attitude towards science

ÖZ

2002 VE 2004 İLKÖĞRETİM FEN BİLGİSİ MÜFREDATLARININ ÖĞRENCİLERİN BİLİŞSEL VE DUYGUSAL ÖZELLİKLERİ AÇISINDAN KARŞILAŞTIRILMASI

ORUÇ, Akif

Yüksek Lisans, Ortaöğretim Fen ve Matematik Alanları Eğitimi Bölümü

Tez Yöneticisi: Prof. Dr. Giray Berberoğlu

Haziran 2009, 116 sayfa

Bu çalışmanın amacı 2004 yılında uygulamaya konulan fen ve teknoloji dersi müfredatının 7.sınıf öğrencileri üzerindeki etkilerini araştırmaktır. Bunun için 2004 müfredatının (1) öğrencilerin fen bilgisi başarılarına etkisi bilgi, kavrama ve üst düzey düşünme becerileri açısından , (2) öğrencilerin fen ve teknoloji dersine karşı tutumları ile (3) fen ve teknoloji dersi öğretmenlerinin sınıf içi uygulamalarına etkisi araştırılmıştır.

Çalışma Ankara ili, Yenimahalle, Sincan ve Mamak ilçelerinde araştırmanın hedefine uygun seçilmiş 6 ilköğretim okulunda, toplam 290 yedinci sınıf öğrencisine, 2006-2007 bahar döneminde uygulanmıştır. 2004 müfredatının çalışıldığı iki okul deney grubu, 2002 müfredatının uygulandığı dört okul kontrol grubu olarak seçilmiştir. Uygulamada 7.sınıflar seçilmiştir çünkü 7.sınıf 2002 ve 2004 müfredatlarının her ikisi de aynı anda yalnızca 2006-2007 eğitim döneminde uygulanmıştır.

Öğrencilere uygulanan başarı testi TIMMS Fen Bilgisi Başarı testlerinde yayınlanan ve araştırmacının test planına uygun şekilde yazdığı sorulardan seçilmiştir. Sorular 2002 ve 2004 müfredatlarının ortak davranış ve kazanımlarını içermektedir. Fen ve Teknoloji dersi Tutum Ölçeği Chaerul (2002) tarafından geliştirilmiştir. Faktör analizi sonuçlarına göre ölçeğin beş alt kategorisinin olduğuna karar verilmiştir. Bunlar: Fen Bilgisinin sosyal hayata etkisi, Bilim insanı yaşam tarzı, Fen bilgisi öğrenme zevki, Boş zamanlardaki fen merakı ve Kariyer ilgisi. Fen ve Teknoloji dersi öğretmenlerinin sınıf içi uygulamaları ölçeği ise Pekiner'in (2007) tezinden alınmış ve ölçekte tespit edilen 5 alt kategori Yeni yaklaşım, Materyal kullanımı, Öğretmenin gösterdiği özen, Klasik sınıf aktiviteleri ve Konu işleme süreci olarak tespit edilmiştir.

Uygulanan anketlerdeki verilerin analizi çok yönlü varyans analizi (MANOVA) test tekniği kullanılarak yapılmıştır. Analiz sonuçları iki fen müfredatı arasında belirli bir fark olmadığını göstermiştir. Diğer yandan öğrencilerin boş zamanlarındaki fen merakı ile öğretmenlerin materyal kullanmaları kategorisinde 2004 müfredatı lehine anlamlı fark olduğu bulunmuştur. Öğrencilerin bilgi ve kavrama düzeyi becerileri, fen bilgisini zevk olarak öğrenmeleri ve öğretmenlerin sınıf aktivitelerini yeni yaklaşımlara göre uygulama kategorilerinde 2002 programının lehine anlamlı sonuçlar elde edilmiştir.

Anahtar Kelimeler: Müfredat gelişimi, fen bilgisi başarısı, fen bilgisine karşı tutum

To My Wife and Son
Sevim and Ahmet Mirza Oruç

ACKNOWLEDGMENTS

I would like to express my sincere thanks to my supervisor Prof. Dr. Giray Berberođlu for his guidance and encouragements during this research. Thank you sincerely.

I wish to thank Arif Oru, Murat Blbl and Muhittin zdemir for their very precious contributions for the analysis.

I would also like to thank my wife Sevim Oru for encouraging and support me for continues to graduate program.

I wish to thank my parents who always support and believe me.

Thank you all very much indeed.

TABLE OF CONTENTS

ABSTRACT.....	iv
ÖZ.....	vi
DEDICATION.....	viii
ACKNOWLEDGEMENTS.....	ix
TABLE OF CONTENTS.....	x
LIST OF TABLES.....	xiii
LIST OF ABBREVIATIONS.....	xv
CHAPTERS	
1. INTRODUCTION.....	1
1.1 The Main Problem and Sub Problems.....	5
1.1.1 The Main Problem.....	5
1.1.2 The Sub Problems.....	5
1.2 Definition of Important Terms.....	6
1.3 Significance of the Study.....	7
2. REVIEW OF LITERATURE.....	8
2.1 Science Education in the World.....	8
2.2 Curriculum Developments in Science in Turkey.....	10
2.3 2002 and 2004 Science and Technology Curricula.....	13
2.4 Constructivism.....	20
2.5 Science Achievement.....	23
2.6 Attitude towards Science and Technology.....	24
2.7 Critical Thinking.....	26
2.8 Assessment.....	28
2.9 Summary of the Literature Review.....	31
3. METHOD.....	34
3.1 Population and Sample.....	34

3.2 Variables.....	38
3.2.1 Dependent Variables.....	38
3.2.1.1 The Dependent Variables for SAT.....	38
3.2.1.2 The Dependent Variables for the TOSRA.....	39
3.2.1.3 The Dependent Variables for the TCAS.....	39
3.2.2 Independent Variable.....	40
3.3 Instruments Used.....	40
3.3.1 Science Achievement Test.....	41
3.3.2 Test of Science Related Attitudes.....	42
3.3.3 Teachers' Classroom Activities Scale.....	46
3.4 Analysis of the data.....	49
4.RESULTS.....	50
4.1 Missing Data Analysis.....	50
4.2 Inferential Statistics	50
4.2.1 Science Achievement Test.....	51
4.2.2 Test of Science Related Attitudes.....	54
4.2.3 Teachers' Classroom Activities Scale.....	58
4.3 Summary of Results.....	63
4.3.1 Results of SAT.....	63
4.3.2 Results of TOSRA.....	63
4.3.3 Results of TCAS.....	64
5.CONCLUSIONS, DISCUSSIONS AND IMPLICATIONS.....	65
5.1.Summary of the Research Study.....	65
5.2 Conclusions and Discussions.....	66
5.3 Internal Validity of the Study	73
5.4 External Validity of the Study.....	73
5.5 Implications of the Study.....	74
5.6 Recommendations for Further Researches.....	75

REFERENCES.....	76
APPENDICES.....	89
A. Science Achievement Test.....	89
B. Table of Specification of Science Achievement Test.....	99
C. The Objectives of Science Achievement Test Questions.....	100
D. Test of Science Related Attitudes.....	110
E. Teachers' Classroom Activities Scale	113

LIST OF TABLES

TABLE

2.1	Primary Science and Technology Course Instruction Curricula 7th Class Learning Areas, Chapters and Suggested Time	17
3.1	The number of the students in pilot and control groups.....	35
3.2	The distribution of students in each school.....	35
3.3	The gender distribution of students in pilot and control groups....	36
3.4	Chi-Square Values.....	37
3.5	The Analysis of the Students' Sixth Grade Level Science grades...	38
3.6	Varimax Rotated Factor Loadings for TOSRA.....	43
3.7	Description of Scales in the Test of Science Related Attitudes (TOSRA).....	45
3.8	Varimax Rotated Factor Loadings for TCAS.....	46
3.9	The Distribution of the Items in the Teachers' Classroom Activities Scale.....	49
4.1	Box's Test Equality of Variance Covariance Matrices of SAT.....	51
4.2	Levene's Test of Equality of Error Variances of SAT.....	52
4.3	Multivariate Tests of SAT.....	52
4.4	Tests of Between-Subjects Effects of SAT.....	53
4.5	Estimated Marginal Means of SAT.....	53
4.6	Box's Test Equality of Variance Covariance Matrices of TOSRA.....	54
4.7	Levene's Test of Equality of Error Variances of TOSRA.....	55
4.8	Multivariate Tests of TOSRA.....	55

4.9	Tests of Between-Subjects Effects of TOSRA.....	56
4.10	Estimated Marginal Means of TOSRA.....	57
4.11	Box's Test Equality of Variance Covariance Matrices of TCAS.....	58
4.12	Levene's Test of Equality of Error Variances of TCAS.....	59
4.13	Multivariate Tests of TCAS.....	60
4.14	Tests of Between-Subjects Effects of TCAS.....	60
4.15	Estimated Marginal Means of TCAS.....	62

LIST OF ABBREVIATIONS

TTKB	Talim Terbiye Kurulu Başkanlığı
TIMMS	The Third International Mathematics and Science Study
PISA	Program for International Student Assessment
SP	Sub-problems
AAAS	American Association for the Advancement of Science
NRC	National Research Council
NBPTS	National Board for Professional Teaching Standards
LASER	Leadership and Assistance for Science Education Reform
ARISE	American Renaissance in Science Education
SCI	Science Curricula Improvement Study
SES	Socioeconomic status
SATKUL	Science Achievement Scores from knowledge and understanding level part of Science Achievement Test
SATHOTS	Science Achievement Scores from higher order thinking skills part of Science Achievement Test
TOSRACISS	Test of Science Relate Attitudes Career Interest in Science
TOSRASISS	Test of Science Relate Attitudes Social Implication of
TOSRAELS	Test of Science Relate Attitudes Enjoyment of Learning Science
TOSRASL	Test of Science Relate Attitudes Scientist Lifestyle
CANATCAS	Classroom Activities Scale Scores from the Classroom Activities of 2004 Approach category

COTTCAS	Classroom Activities Scale Scores from the Care of Teacher category
UETCAS	Classroom Activities Scale Scores from the Use of Equipment by teachers category
CCATCAS	Classroom Activities Scale Scores from the Classical Classroom Activities Category
PSTCAS	Classroom Activities Scale Scores from the Processing the Subject category.
SAT	Science Achievement Test,
TOSRA	Test of Science Related Attitudes
TCAS	Teachers' Classroom Activities Scale

CHAPTER 1

INTRODUCTION

Education is considered as not only a constitutional right and a mission of the social law state, but also the most productive field of producing educated man power in the view of economy (Talim Terbiye Kurulu Başkanlığı, 2005).

In the era of knowledge and technology, science and technology education have a key role for the future of societies. Due to its importance, developed countries, as the head, all societies are in effort to enhance the quality of science and technology education. So the countries compete to give better education for their individuals in this rivalry atmosphere (Bayrak & Erden, 2007).

Organizing education programmes according to the contemporary necessities has priority as it forms a ground for other conditions (TTKB, 2005). The quality of education depends upon the quality and standard of the curricula. It means that curricula plays a vital role in an educational process.

In order to reach the goal, the Ministry of Education has changed the elementary school science education curricula and also the name 'Science Course' to the name 'Science and Technology Course' in the beginning of the 2004-2005 education semesters.

2004 curricula was applied in 6 cities at 104 pilot schools. In 2005-2006 education semester, new curricula has begun to be practiced officially at from 1st class to 5th class in all schools and the books written as convenient to the

curricula, has begun to be used. In 2006-2007 education semesters the curricula was tested on 7th grade students at certain schools. In the 2007-2008 academic year the new science and technology curricula was implemented in all the schools in Turkey.

There are various reasons to construct a new science and technology curricula in Turkey. The major reason depends on the poor results Turkish students indicated in the international assessment programs. From this perspective the results of the TIMSS (The Third International Mathematics and Science Study) and PISA (Program for International Student Assessment). TIMSS-R (TIMMS Repeat) projects could be evaluated as the outcome of the previous science curricula in Turkey. These projects indicated that Turkey's science scores were significantly below the international averages (Gonzalez & Miles, 2001).

TIMSS provided a chance to find out educational system's situation for countries. Turkey's rank is 33 in science achievement out of 38 countries. TIMSS reported definitions and student distributions of 90th, 75th, 50th, and 25th percentiles in science achievement and according to these reports 87% of Turkish students are at or below 50th percentile, which is defined by the following sentences: "Students can notice basic scientific knowledge and express them (50th percentile)" and "Students express some basic phenomena related to earth, life and physical sciences that they know in non-scientific terms" (25th percentile). Similarly, science item averages of Student Selection Examination (OSS), which is approximately 5 out of 45 items, this also shows low level of science education (OSYM, Official web page). The average science achievement scores of the Turkish students in OKS examination is 5.73 in 2007 and 5.29 in 2008 out of 25 questions (MNE, 2004a). It is obvious that there is something wrong in science education of Turkish national education system.

Current studies showed that in Turkey, students have difficulties to integrate or contrast the scientific knowledge and they are unable to make connections of

these facts with real-life applications (Sutman, 1993). The new way to teach science, based almost completely on direct instruction lessons, has left our students scientifically illiterate and conceptually ignorant (Carey, 1997). The epistemology that is dominant in most classrooms today is influenced by objectivist philosophy; most teachers view knowledge as something outside the student for the teacher to give to the student. Knowledge is out there to be had, residing in books and independent of human beings (Lorsbach & Tobin, 1997).

2004 Elementary Science and Technology Curricula is told to have a constructivist and cognitive approach. It is based on constructivist approach, student-centered instruction, multiple intelligence theory, and sensitivity to individual differences.

Constructivism is a learning theory that holds that knowledge exists only in the cognitive domain where it is constructed by each one in an individual way (Dewey, J. 1916). In a constructivist classroom environment, the teacher's role changes to one of guiding rather than telling the learner the information (Applefield, J.M., Huber, R. & Moallem, M., 2001). 2004 curricula also aims to provide the students to develop a full range of intellectual capacities.

Knowledge is actively constructed by the learner, not passively received from the environment. Learning requires work and follows a definite hierarchy from simple concepts to the more complex (Sutman, 1993).

2002 curricula aims students to solve problems by scientific methods, to comprehend the creative, critical and scientific thinking as foundation of scientific and technological development and to pay attention and interest to the scientific improvements so that they will gain the knowledge and practice them. When the existing new science and technology curricula is compared with respect to the previous one, there were some major similarities reported as well as the differences. 2004 curricula contains chapters and objectives of 2002 curricula and

also it has other different chapters. Generally 2004 curricula contains the aims of 2002 curricula. It must be noted that 2002 curricula didn't have any aims or goals contrary to 2004 curricula. Also 2002 curricula didn't include any components contrary to constructivistic approach. It can also be said that, 2002 curricula is a student-centered based curricula.

The purpose of this study is to investigate the effect of 2004 elementary science and technology curricula at grade level 7. For this purpose, the effect of 2004 curricula on the (1) achievement of the students in knowledge, conceptual understanding and higher order thinking skills clusters, (2) attitude toward science and technology, (3) teachers' classroom activities were evaluated.

This study was conducted on 290 7th grade students at six elementary schools in 2006-2007 spring semester. These schools were located in Sincan, Yenimahalle and Mamak in Ankara. Convenience sampling was used to obtain a representative sample of pilot schools. First the district was chosen by the convenience sampling method and all schools were selected conveniently with the consideration of being close to each other. While assigning the groups demographic characteristics and gender were taken into account. Also convenient classes, administrations and teachers were chosen. Two schools were administering 2004 curricula as pilot group and four of them were teaching science with 2002 curricula. Grade level 7 was selected for the study since both 2002 and 2004 curricula were being implemented in the schools only at this particular grade level.

1.1 The Main Problem and Sub Problems

1.1.1 The Main Problem

The main problem of this study is stated as follows;

Are (a) students' science achievement in terms of knowledge and understanding levels and higher order thinking skills (b) attitudes of students towards science (c) teachers' classroom activities, different across 2004 and 2002 science curricula at grade level 7?

1.1.2 The Sub Problems

The following sub-problems (SP) were investigated as part of the main problem.

SP1: Is there a significant difference in the mean scores of science achievement scores of 7th grade students across 2004 and 2002 science curricula in terms of students' a) knowledge and understanding level outcomes and b) higher order thinking skills outcomes?

SP2: Is there a significant difference in the mean scores of students' attitudes towards science across 2004 and 2002 science curricula?

SP3: Is there a significant difference in teachers' classroom activities across 2004 and 2002 science curricula?

1.2 Definition of Important Terms

This section presents some important definitions related to this study.

Achievement: Academic achievement is the outcome that students acquire after the learning process. It is measured by the score attained on the achievement tests designed by the researcher. Johnson states that achievement refers to the 2002 indices of the degree to which a student has encountered success in school. (Johnson, 1992)

Attitude: A common definition has involved describing attitudes as including the three components of cognition, affect, and behavior (e.g., Bagozzi & Burnkrant, 1979; McGuire, 1985; Rajecki, 1990). Reid (2006, p. 4) provides a clear definition of these components:

- (1) A knowledge about the object, the beliefs, ideas component (Cognitive);
- (2) A feeling about the object, like or dislike component (Affective); and
- (3) A tendency-towards-action, the objective component (Behavioral).

Critical Thinking: A disciplined mental activity that evaluates arguments and makes judgments that guide the development of beliefs and actions (Huit, 2000).

1.3 Significance of the Study

There are few studies related to the effects of 2004 elementary science and technology curricula for 7th grade students' achievement, attitude, learning styles and techniques used in the lessons. It is worthwhile to explore the current situation in science education for obtaining a panorama of education system. One of the most important expected findings of this study is that it may show the effects of factors such as student-centered, teacher-centered instruction on science achievement of the students.

To sum up, results of this study are expected to explain the effects of 2004 elementary science and technology curricula on science achievement, attitude, learning style and techniques used compared with the 2002 science curricula. This will be an opportunity to be used in revising 2004 elementary science and technology curricula.

CHAPTER 2

REVIEW OF LITERATURE

2.1 Science Education in the World

Modernist science arose from the work of 16th-17th century natural philosophers (such as Bacon, Descartes and Newton) for whom scientific knowledge was an all-powerful internalized representation of reality arising from empirically-grounded inductive reasoning. During the age of Enlightenment, modernist science was heralded as the royal road towards unlocking the mathematical laws of a purportedly logical and ordered universe, and yielding rational control over both the natural and social worlds. In the late 19th and early 20th centuries, modernist science was deified by the (logical) positivists who privileged empirical verification and value-neutral standards of objectivity (Vanderberg, 1990).

The changes in the Sputnik reform were strongly supported by the influential learning theorist, Jerome Bruner (1915-), who welcomed discovery techniques for students (Klein, 2003), and who shared the Vygotskian notion that all learning takes place in a cultural context (Bruner, 1966). He integrated culture, history, and biology into the study of child development (Lyle, 2000), and suggested that people compartmentalize their interpretation of the world by similarities and differences (Bruner, 1960). His work has had a significant impact upon cognitive learning.

In the field of science education, a much quieter revolution occurred. The American Association for the Advancement of Science (AAAS) launched its innovative Project 2061 in the 1980s (Nelson, 1999). This association has produced numerous publications that have influenced curricula reform at local, state, and national levels: AAAS (1990), Benchmarks for Science Literacy (1993), Blueprints for Reform (1998), and Designs for Science Literacy (2001), (AAAS, 2004; Bardeen & Lederman, 1998; Nelson, 1999).

These publications recommend the knowledge and skills in science, mathematics, and technology that students should have as well as the benchmarks to accomplish this goal (Bardeen & Lederman, 1998; Nelson, 1999; Rutherford & Ahlgren, 1989; Sirica, 1997). The benchmarks are consistent with Gagne's philosophy that practice and assessment in the classroom should match the target skill desired. With the philosophy that less is more, Project 2061 determined a set of essential and enduring concepts that provide a solid base for further learning (Rutherford & Ahlgren, 1989).

Now approximately 15 years into the current Science Reform effort, the improvement of science education is still a major priority of the National Research Council (NRC). The NRC's National Science Education Standards (1996) affirms many of the aims of a contextual approach to science education and emphasizes depth rather than breadth (Moreno, 1999). The science Standards state:

1. Scientific literacy should include the understanding of the nature of science and the role of science in society and personal life.
2. Effective teachers of science should possess broad knowledge of all disciplines and a deep understanding of the discipline they teach (Moreno, 1999).

An ongoing NSF project for the improvement of K-12 science instruction is the Leadership and Assistance for Science Education Reform (LASER) that was

launched in 1998 by the National Science Resources Center (NSRC). This new collaborative model that began a nationwide initiative in 2002 for promoting and sustaining science education reform continues today (LASER, 2004). Members of vertical teams work together on ways in which to explore, adopt, and implement effective, inquiry-centered K-12 science education programs. The meeting in 2003 concentrated on K-8 reform and the meeting in 2004 concentrated on reform in grades 6-8 (LASER, 2004).

2.2 Curriculum Developments in Science in Turkey

Curriculum studies in Turkey have an extensive back ground that goes back to the early mid-nineteenth century when the first general elementary school curricula was introduced (Varış, 1996). In the twentieth century, there were more systematic innovations in curricula development studies starting with the establishment of the Republic in 1923. A year later, in 1924, with the Law of Unification of Instruction, the Ministry of National Education became the only authority responsible for the operation of all educational institutions (Gozutok, 2003). The Turkish Educational System was centralized by the act of this law. All schools throughout the country had to use the same curricula (Ayas, *et al*, 1993). Considering the needs of newly established Republic, initial curricula development studies in elementary education (The Primary School Curricula) began just after the Law was put into effect. After a two-year implementation of the curricula, a major revision was accomplished by considering the needs of the country and developmental characteristics of students. The revised Primary School Curricula was in effect for ten years until a new round of curricula development study was conducted in 1936.

Between 1932-1937 high-quality science text books were translated into Turkish, books were designed to give knowledge on daily life as well as theory. In

the following years, due to changes in the economical, political, and social structures of the Turkish society, a need arose to revise the curricula; as a result, in 1948, the curricula faced new changes. The principles of the Primary School Curricula were rearranged and grouped under four elements: social, individual, human relations and economics (Binbasioglu, 1995). Between 1937 and 1951 it was decided to write original text books, but quality of these books was not as much as expected.

In 1950s objectives of science education were re-stated by collaboration of Turkish and foreign educators. Scientists and researchers were assigned to examine educational system of foreign countries (Ayas et al, 1993; Turgut, 1990).

In 1962, there was another curricula initiative to align the existing content of the curricula to the necessities of the society and country. In the 1962 model, the 14 different subject fields of the 1948 Curricula were grouped under five content areas according to their relations. This model also was so flexible that the consumers of the curricula could alter the program according the needs of the local community (Karagoz, 1965). The 1962 Curricula was in use for six years. During this time frame, classroom teachers, academicians from universities and other curricula experts continuously monitored the implementation process and revised the program. The revisions were finalised in 1968 and officially approved as the 1968 Curricula.

There was no “separate” science course in elementary school programs from 1924 up to 1974. The science subjects were included to some degree in “Knowledge of Life” lesson in a heterogeneous form. Only after 1974 science courses became separate and given some importance.

Later, in 1982, a new program model was presented by the Ministry of National Education. This program was prepared through collaborations with universities. The rapidly changing nature of the society, technology and culture resulted in a new wave of curricula change in the early 1990s under the guidance of the National Education Development Project supported by the World Bank. With this project, it was planned to develop high quality instructional materials and textbooks for improving the level of schooling in Turkey. As a result of these efforts, in 1993, a new curricula was adopted by the Department of National Educational Research and Development of Education (EARGED) in cooperation with the National Education Development Project.

Between 1993 and 2003, revisions were carried out in individual content area curricula. For instance, the science curricula in 2002 was considerably revised. Lastly, in 2004, new curricula studies concerning five content areas, including mathematics, science, social science, life science, and Turkish were initiated by the Ministry of National Education.

2004 curricula was applied in 9 cities at 120 pilot schools. The teachers in pilot schools attended to seminars during ten days and they were informed about 2004 approaches and applications. In 2005-2006 education semester, new curricula has begun to be practiced officially at from 1st class to 5th class in all schools and the books written as convenient to the curricula, has begun to be used. In 2006-2007 education semesters the curricula was tested on 7th grade students at certain schools. In 2007-2008, it began to be applied for all 7th class students.

Though first studies on science education in Turkey have its roots in 1930s and since then there has been a huge knowledge and experience accumulation on the issue, science education in Turkey has not achieved to the expected level and has still been far from its objectives.

2.3 2002 and 2004 Science and Technology Curricula

1992 curricula, put in to practice before 2002 curricula, gave importance to direct or indirect transformation of the knowledge to the students. So it remained primitive according to the other countries' curricula in the view of learning by scientific and critical thinking and exploration. As a result, 2002 elementary science curricula has been put in to practice in 2001-2002 academic year. 2002 curricula aims students:

1. to solve problems by scientific methods
2. to comprehend the creative, critical and scientific thinking as foundation of scientific and technological development
3. to pay attention and interest to the scientific improvement so that they will gain the knowledge and practice them.

When 2002 curricula and 2004 curricula were compared, 2004 curricula contains chapters and objectives of 2002 curricula and also it has other different chapters. Generally 2004 curricula contains the aims of 2002 curricula. It must be noted that 2002 curricula didn't have any aims or goals contrary to 2004 curricula. Also 2002 curricula didn't include any components contrary to constructivistic approach. It can also be said that, 2002 curricula is a student-centered based curricula.

The 2004 curricula is designed under the guidance of a common set of fundamentals with four components, (a) Social, (b) Individual, (c) Economical and (d) Historical and Cultural fundamentals. The Turkish Ministry of National Education (MNE) proposed that the fundamentals would serve as an umbrella guiding the overall initiative (MNE, 2004a).

The 7th class 2004 Science and Technology Course Instruction Curricula consists of two main parts. In the first part ‘Fundamentals of the Curricula’ the vision, technology approach and learning-teaching philosophy of the curricula are given with the main principles. The titles ‘Learning Areas’ and ‘Chapters’ are in the second part. In this part science and technology objectives, activity examples and explanations are presented. This structure of the curricula provides simplicity for the teachers.

The vision of 2004 Science and Technology curricula is expressed as “...making all the students science and technology literate people no matter what the individual differences they have” (Öğretmenler Portalı-Teachers’ Portal, 2006). 7 dimensions can be taught for being science and technology literate:

1. The nature of Science and Technology
2. Key science concepts
3. Science Process Skills (SPS)
4. Science-Technology-Society-Environment (STSE)
5. Scientific and technical psychomotor skills
6. The values composing the soul of science
7. Attitudes and Values (AV)

The educational goals of 2004 curricula can be grouped into three areas: (a) ability to understand the nature of science and technology and the mutual interactions among the science, technology, society, and environment, (b) proficiency in using science and technology during problem solving, decision making and constructing new knowledge, (c) awareness of career options regarding with science and technology and using relevant knowledge and skills to improve economic productivity.

There are four groups of learning goals regarding with knowledge, science-technology-society-environment, scientific thinking skills, and attitude and values. In the curricula, not only knowledge but also skills, values and attitudes are

included when writing the learning objectives and their relationships are stated in the document explaining the organization of each unit.

2004 science and technology curricula has many characteristics: it has seven learning areas with four content strands supported by skills, understanding and attitudes; there is a spiral approach for each strand; mainly based on the constructivist approach; enriched with teaching activities and multiple assessment methods and techniques. The Seven Learning Areas are the following:

- Physical Processes
- Life and Living Beings
- Matter and Change
- The Earth and the Universe
- Science Process Skills (SPS)
- Science-Technology-Society-Environment (STSE)
- Attitudes and Values (AV)

While the first four of these represent the content areas, the remaining three are interwoven into them throughout the grades. Although, they are not included as separate units they are visible in all content area units. This approach clearly indicates the intent of having pupils engaged in student-centered activities while learning the content. Learning by doing is seen to be a central pillar of 2004 curricula. The structure of the curricula is established so that students may bring their daily life experiences into classrooms and, conversely, can take out their school experiences outside the school. In order to realize this, several suggested activities are provided in order to incorporate many related curricular outcomes to technology understandings (Koc, Y. & Isiksal, M. & Bulut, S. , 2008).

The program labels the chief learning areas as “Living Things and Life, Matter and Change, Physical Events, The Earth and The Universe”. It seems that the curricula is covered at increasingly higher levels of difficulty in grade six

through grade eight. How the learning goals to be acquired at the end of each unit are related with the science concepts and skills in other class levels. In Table 2.1 ‘Primary Science and Technology Course Instruction Curricula, 7th Class Learning Areas, Chapters and Suggested Time’ learning areas, chapters, the number of objectives, time and percentages are given. There are 7 chapters and 204 objectives to be instructed in 144 lectures.

In every chapter of the Science and Technology course instruction curricula the following parts exist:

- A. General View,
- B. The Aim of the Chapter,
- C. Chapter Focus,
- D. Suggested Subject Titles,
- E. Concept Map of the Chapter,
- F. Chapter Objectives and Activities,
- G. Suggested Evaluation Activities,

In chapter objectives and activities part, the first objective is numbered as 1. 1. The first 1 defines the first main objective of the chapter and the second 1 defines the first objective of the first main objective. At the end of the objective sentence, SPS 1 is given. This number relates the objective: ‘1. Nesneleri (cisim, varlık) ve olayları duyu organlarını veya gözlem araç gereçlerini kullanarak gözlemler.’ which is given in Science Process Skills. Every objective is related with Science Process Skills (SPS), Science-Technology-Society-Environment (STSE) or Attitudes and Values (AV). There are activity examples, warnings, limitations, interdisciplinary relations, misconceptions, relations with other courses, measurement and evaluation parts. The example activities are written according to specific objectives and the number of these specific objectives are at the end of the examples (MEB, 2004).

Table 2. 1 Primary Science and Technology Course Instruction Curricula
7th Class Learning Areas, Chapters and Suggested Time

LEARNING AREA	CHAPTERS	The Number of Objectives	Time/ Lecture Time*	Percentage (%)
Life and Living Beings	1. The Systems in Our Body	27	30	20,8
	6. Human and Environment	12	16	11,1
	Total	39	46	32
Matter and Change	4. The Structure and Properties of the Matter	46	36	25
	Total	46	36	25
Physical Processes	2. Force and Motion	31	16	11,1
	3. Electricity in our Life	32	16	11,1
	5. Light	29	16	11,1
	Total	92	48	33,3
The Earth and the Universe	7. Solar System and Beyond: Space Puzzle	27	14	9,7
	Total	27	14	9,7
	Total	204	144	100

*: The given lecture time can be changed in the ratio of $\pm 10\%$ by the teacher.

The assessment system as introduced by the curricula aims at monitoring the process as well as the product (Linn and Miller, 2005). The curricula also introduces alternative assessment strategies such as portfolios, projects, checklists and other performance-based media of assessment besides standardised and classroom tests for the improvement of the school system. Such assessment techniques are suggested as an invaluable tool to collect information on the process used (for example, problem solving strategies or interpretation of the findings) and product or outcome of the process (for example, completed project work or written report). The 2002 assessment techniques such as paper and pencil tests do not necessarily help teachers monitor student progress as much as do performance-based assessment tools (Linn and Miller, 2005; Thorndike, 2005). In essence, 2004 curricula takes a radical approach toward improving the assessment system by utilising new and alternative assessment strategies. Finally, as indicated by Romberg, reform in the curricula requires further reform in classroom assessment (Romberg, 2004).

Thus, a comparison of 2002 and 2004 curricula on the surface indicates that both look quite similar in terms of the content they cover; though, opposite to the nature of 2002 curricula, 2004 brings various characteristics of the reformist movement around the world such as considering interdisciplinary connections, and the use of technology and other instructional tools. As a result, the reformist wave in education has arrived in Turkey and significantly influences the elementary school curricula.

The curricula change initiated other associated movements in the education arena of Turkey. For example, the publication of new textbooks aligned with the curricula has already been started. For the first time in Turkey, student workbooks and teacher editions are being published to support the student textbooks.

With the recent changes made in the curricula a course titled ‘Science and Technology’ is offered in grades 4-8. A notable feature of 2004 curricula is that technology education is now being integrated into science education and in this way sharing the higher status of the science course.

2004 curricula, where appropriate, prompts teachers to such important student misconceptions identified in the literature. Another purpose is to alert teachers to those wide spread misconceptions since often times the teachers may have persistent misconceptions themselves.

Another big improvement was made in the weekly course hours with 2004 curricula. Science courses in grades 4-8 were given 3 class hours per week, but with the current reform efforts the weekly hours were increased to 4 class hours per week. Currently, in grades 4-8 pupils take 144 lecture hours of the science and technology course in each grade.

Besides all of these reformist movements, there are serious problems about the expressions of the objectives. The expressions of the present objectives as examine, clarify, specify, realize, express, name, make are used frequently. So we can only develop the knowledge and conceptual understanding level of the students by the present objectives. 2004 science and technology curricula is far from developing the higher order thinking skills level of the students as it is claimed. The objectives should include expressions such as compare, reach the result by the means of observation, hypothesize, differ, interpret, classify. As a result, the test questions of SBS don’t measure the higher order thinking skills level of the students. The expressions of the objectives must be reconstructed (Cito Türkiye Bilim Kurulu, 2008).

2.4 Constructivism

2004 Turkish Curricula in Science can be partly considered a constructivist curricula. Constructivism implies that the student is always an active agent in the process of meaningful learning (Matthews, 2000).

Constructivism, as a theoretical framework, was set forth by psychologists Piaget and Bruner. It is an epistemology, used to explain how we humans learn. According to constructivism, knowledge cannot be transferred from the teacher to the student intact, the student constructs knowledge for him or herself based on prior experience and understanding. According to Sigel, Piaget noted that knowledge is not merely transmitted verbally but must be constructed and reconstructed by the learner, and that for a child to know and construct knowledge of the world, the child must act on objects and it this action which provides knowledge of those objects (Sigel, 1977).

Piaget (1969), the "pioneer of constructivist thought", affirmed that new knowledge needs to be connected to what is already known. This process is adaptation. If 2004 knowledge is in concert with what is already known, the knowledge is readily accepted. If it is in opposition to what is known, or counter intuitive, it causes disequilibrium. If and when the disequilibrium is resolved this is assimilation (Staver, 1986).

Piaget believed that people construct knowledge and adapt to a learning environment by assimilating new information and integrating it with their prior knowledge. Piaget's theories have been criticized because he did not consider the effect of social interaction in this learning process, that is, how interaction with others can cause change (Semple, 2000)

Bruner moves into an interactionist position in his theory of learning, encompassing constructivism, and emphasizing the roles of exchange between

teacher and learner in the acquisition of knowledge. He developed the notion of "The Spiral Curricula" (Howe & Jones, 1993, p. 28), whereby the curricula should involve the mastery of skills that lead to the mastery of higher level skills throughout a child's academic career. For example, the topic of acceleration can be taught in a simple way in first grade, to a more complex way in middle school, to a very detailed formula driven physics class in high school.

According to Bruner (1966), learners construct their own meaning through concept formation, and that the learner selects and transforms information, constructs hypotheses, and makes decisions relying on mental models to do so. In order to operationalize Bruner's theories, teachers must be active problem solvers with expectations for the students to be interactive learners. Process is important to Bruner, therefore science education is the perfect vehicle with which to carry out his ideas.

Vygotsky influenced modern constructivist thinking by suggesting that an individual's culture influences his/her social and cognitive development. Vygotsky used a system known as cooperative learning, a teaching technique used in today's classroom (Henson, 2003).

Constructivism is a learning pedagogy that is student-centered and based on a learning theory that focuses on how students develop understandings. Constructivism is also the notion that children build knowledge from their own experiences (Richardson, 1999).

Note that the role of teaching according to Dewey is not to lecture and impart knowledge, but to direct student activity to discover their own knowledge. The classroom consists of a "social environment" (Dewey, 1916, p. 14).

Constructivism is based on the notion that students build knowledge by continually restructuring new information to fit existing concepts. The Learning

Cycle is a conceptual-change model of instruction that is consistent with concept formation. It has several components that are similar to reciprocal learning. The three-stage model is as follows:

1. Exploration Phase- Teacher gives students materials and encourages exploration and questions about things dealing with new materials that they do not understand.
2. Concept Introduction Phase- Teacher introduces and explains key concepts, may illustrate, diagram. Textual readings become more purposeful.
3. Concept Application Phase- Teacher helps the students apply newly learned concept to new situations (Dewey, 1916, p. 14).

Employing the learning cycle also clarifies students' thought processes and misconceptions. Students have the opportunities to explain and debate their ideas, thereby giving teachers good insight as to why students are arriving at certain answers or viewpoints (Bevevino et al, 1999).

The results of the researches about science education verifies that constructivist approach is useful to fulfill science education purposes. Constructivist approach suggests that individual constructs knowledge in his mind in an active way. In spite of its being an approach about how knowledge is gained, constructivist approach is also very successful to understand and interpret the learning and teaching experiences. Man constructs new knowledges; evaluates reorder or refuses them while he is interpreting all around himself. Relation between learning and teaching is not direct and one to one. In other words, knowledge and skills are not transferred to students as if they are ready to be loaded (MEB, 2004).

After all these explanations how can we relate 2004 science and technology curricula with constructivist approach? Is 2004 science and technology curricula consistent with the constructivist approach?

2004 curricula has a spiral structure for each strand. This structure has brought a repetition of the same objectives in every class levels and as a result of this, the students get bored of learning the same concepts every year.

The curricula introduces alternative assessment strategies such as portfolios, projects and checklists but details of the instructions about these new strategies aren't given in the curricula book.

One of the main claims of 2004 curricula is 'less but deeper information is more'. When we compare the number of the objectives of 2004 and 2002 curricula, it is seen that subject variety and number have increased in 2004 curricula.

2.5 Science Achievement

Shavelson and Ruiz-Primo (1988) studied the effect of performance-based assessment on science achievement. The most important influence on individual differences in teacher effectiveness is teachers' general cognitive ability, followed by experience and content knowledge.

Another factor affect student achievement is homework. Trautwein and Köller (2003) illustrated a class-level and student-level effect of homework. Moreover; the relationship between time spent on homework and achievement gains at the student level is unclear (Trautwein & Köller, 2003).

San Diego County Office of Education (1997) searched to find the answer of the question “What is the influence of parental involvement on student achievement?” According to review results student achievement improves when parents express high (but not unrealistic) expectations for their children’s achievement and future careers, parents become involved in their children’s education at the school and in the community, parents are enabled to play four key roles (as teachers, supporters, advocates, and decision makers) in their children’s learning.

Betts, Zau and Rice (2003) surveyed the school and the classroom factor affecting student achievement. The study defined school resources not as funding per pupil but rather in terms of class size and teacher training. They found that in most cases lowest socioeconomic status (SES) schools received fewer resources.

In general class size appears to matter more in lower grades than in upper grades, whereas teacher qualifications such as experience, level of education, and subject area knowledge appear to matter more in upper grades (Betts, Zau & Rice, 2003).

2.6 Attitude towards Science and Technology

A common definition has involved describing attitudes as including the three components of cognition, affect, and behavior (e.g., Bagozzi & Burnkrant, 1979; McGuire, 1985; Rajecki, 1990). Reid (2006, p. 4) provides a clear definition of these components:

- (1) A knowledge about the object, the beliefs, ideas component (Cognitive);
- (2) A feeling about the object, like or dislike component (Affective); and
- (3) A tendency-towards-action, the objective component (Behavioral).

This definition makes clear that we are looking for something different from general affects, such as moods (e.g., being sad or happy) and emotions (e.g., fear and anger) (Ajzen, 2001) Therefore, the definition for attitude that we use for this study is that it is the feelings that a person has about an object, based on their beliefs about that object. (Per Kind, Karen Jones and Partick Barmby, 2007)

Without positive attitudes and perceptions, students have little chance of learning proficiently, if at all. In other words, for learning to occur, students must have certain attitudes and perceptions. Feeling comfortable in the classroom, for instance is important to learning. If a student doesn't believe the classroom is a safe and orderly place, she will probably learn little in that classroom. Similarly, if she doesn't have positive attitudes about classroom tasks, she probably won't put on much effort in to them and again her learning will suffer. A primary focus of effective instruction, then establishing positive attitudes and perceptions about learning (Marzano, R.J., Pickering, D. and Tighe, J. 1993).

Lawrenz (1976) tried to predict student attitude toward science from the student perception of the classroom learning environment. The data were collected from a sample of classes stratified on levels of population from three general mid western regions, which included 12 states. Sample consisted of 238 high school science classes. The instruments used in the study were SAI and LEI. Of the two tests used in his study SAI measures science attitudes with 60 likert-type items and a test-retest reliability of 0.93. The second instrument LEI has 10 scales which describes aspects of classroom social situations. The stepwise multiple-regression analysis was used. Students' perception of classroom learning environment related to student achievement in science and also related to student attitudes toward science (Lawrenz, 1976).

Heide (1998) has demonstrated that students' attitudes towards science are more positive when they engage in behaviors such as choosing problems and finding solutions to those problems (student-centered), working in large and small

cooperative groups, performing hands-on science laboratory experiences and learning through conceptual understanding rather than memorization.

Lewis (1996) proposed that student attitudes toward technology are influenced by different educational approaches. These approaches include teaching methods, student-teacher interaction, and learner outlook about web-based education. Such strategies frequently affect students' general attitudes toward technology. Also, according to research, technology education practices and their results are grounded in determining factors, which are teachers' knowledge, external resources, attitudes, motivation, and values (Osterman & Kottkamp 1993).

Baykul (1990) found that Turkish students' attitudes toward science and mathematics courses substantially decreased from grade 5 through grade 11.

2.7 Critical Thinking

The definition of critical thinking has changed somewhat over the past decade. Contributions to the present definition of critical thinking come from (a) cognitive psychologists, who work to establish the differences between critical thinking and other aspects of thinking; (b) philosophers, who state that critical thinking is a process of thinking to a standard; (c) behavioral psychologists, who help establish the operational definitions associated with critical thinking; and (d) content specialists, who demonstrate how critical thinking can be taught in different areas (Huit, 2000). Huit prefers a definition that is closely aligned to Bloom's concept of evaluation. He defines critical thinking as a disciplined mental activity that evaluates arguments and makes judgments that guide the development of beliefs and actions (Huit, 2000).

There are several ways to operationalize ideas about teaching at higher levels. The first is to employ Benjamin Bloom's Taxonomy of cognitive levels. In 1956, Bloom developed a classification system whereby intellectual behavior important to learning was separated into three domains: Cognitive, Psychomotor, and Affective. The Cognitive Domain was further divided into six levels, which demonstrate different intellectual skills. These go from the lowest levels of learning to the highest. (Verb examples are included that represent measurable intellectual activity).

1. Knowledge (lowest level) arranges, define, duplicate, label, list, memorize, name, order, recognize, relate, recall, repeat, and reproduce.
2. Comprehension: classify, describe, discuss, explain, express, identify, indicate, locate, recognize report, restate, review, select, and translate.
3. Application: apply, choose, demonstrate, dramatize, employ, illustrate, interpret, operate, practice, schedule, sketch, solve, use, write.
4. Analysis: analyze, appraise, calculate, categorize, compare, contrast, criticize, differentiate, discriminate, distinguish, examine, experiment, question, and test.
5. Synthesis: arrange, assemble, collect, compose, construct, create, design, develop, formulate, manage, organize, plan, prepare, propose, set up, and write.
6. Evaluation: (highest level) appraises, argue, assess, attach, choose compare, defend estimate, judge, predict, rate, core, select, support, value, evaluate (Bloom, 1956).

The main concept in Bloom's taxonomy is that required knowledge can be spiraled in a hierarchy from simple to more complexes (Gagne & Dick, 1983). There is, however, discussion on the relationship of synthesis and evaluation in

this hierarchy; some researchers reverse the order and others consider them to be two separate but parallel levels of learning (Huit, 1998)

The mathematics included in science intimidates many students. Not only do science students have to memorize mathematical formulae, they are then asked to grasp difficult scientific theory in application of the concepts. The problem lies in assessing the higher levels of learning, where memorization is the lowest (Bloom, 1956).

2.8 Assessment

According to Applefield et al (2001), the more 2002 teaching techniques employ a bottom-up strategy that isolates the basic skills, teaching them separately and building these before taking on higher order tasks. Constructivism does the opposite, and instead of structuring the elements of any topic to be learned, real learning proceeds from the natural need to form understanding and necessary skills required for completion of real problem-solving tasks. Also, results of standardized test scores show that less successful students are not making progress in mastering basic content in science, and there is evidence that they are falling behind their classmates in other subjects (Applefield et al 2001).

Taba developed a model to categorize information. It is a multi-purpose approach that provides an occasional teaching option. The method involved three stages:

1. Students make an exhaustive list of observations, ideas, or concepts.
2. Students gather all similar items together.

3. Students name each category. They then are assigned to category groups and proceed to research their topic. The teacher's role is to facilitate acquisition of relevant information sources. The final product is a report, portfolio, project, or video presentation (Armstrong, 1998).

Gardner (1999), in his book The Disciplined Mind, writes that students should be taught fewer concepts in school, but at greater depth. His main argument is toward teaching for understanding. Gardner states: "Let me introduce my alternative educational vision-one firmly centered on understanding. An individual understands a concept, skill, theory or domain of knowledge to the extent that he or she can apply it appropriately in a new situation. An individual with a keen memory merely remembers the information and has not a clue about how to use it appropriately in an unfamiliar circumstance" (p. 118-119)

Gardner defines an individual who understands what he or she is taught as one who, while possessing relevant understanding, can employ appropriate concepts while dismissing irrelevant ones (Gardner, 1999). Gardner also poses that observers may be impressed by how much information the child seems to be learning, if one weighs only the mastery of individual numbers, facts, definitions, etc. He also implies that of all the disciplines, the telltale weakness is found among physics students in colleges and universities, indicating that the pattern of teaching for factual memorization continues throughout their educational career. The students perform credibly in classroom exercises and end-of-term tests. But outside class, when they are asked to explain relatively simple phenomena, such as the forces operating on a tossed coin, a significant proportion of students (often more than half) failed to give the appropriate explanation. Physics students also tend to give the same kind of answers as peers and younger children who have never studied mechanical physics. They do not understand concepts, but can pass a standardized test because they have memorized the information and are practiced at multiple-choice tests (Gardner, 1999).

According to Shepard (2000), a broader range of assessment instruments is needed to measure learning goals and processes and to connect assessment directly to ongoing instruction. While multiple choice standardized tests are appropriate for measuring certain levels of acquired knowledge, Shepard suggests more open-ended performance tasks for measuring higher level thinking skills. Not only do teacher made tests measure low-level thinking skills, so do state and district tests.

According to Gega and Peters (1998), these alternative assessment tools successfully measure higher-order thinking skills:

1. Performance-based assessment-models based on scientific concepts, experiments, journals, written material including papers.
2. Projects-requires self-assessment from start to finish. Students display critical thinking, persistence, inventiveness, and curiosity.
3. Peer or self-designed instruments- rubrics, surveys. Promotes independence and ownership.
4. Interviews-are effective ways of gaining information with students with writing problems or with very early elementary aged students who cannot express themselves in writing.
5. Journals- useful ways to get students to write to learn.
6. Portfolios- a sample of work collected over time, a good self-assessment tool.
7. Concept maps- organize thoughts and concepts. Helps to see how things are connected, including old and new information.

8. Teacher observations- an informal, on-going tool that puts learning in context.

9. Questioning techniques- open ended questions where there is more than one correct response (Gega & Peters, 1998).

In justifying alternative assessment, Gardner (1983) posits that there are at least seven types of intelligence to be found in schoolchildren. He names these as linguistic, musical, logical/mathematical, spatial, bodily/kinesthetic, interpersonal, and intrapersonal. By today's standards, only two of these areas are measured by standardized tests, linguistic and logical/mathematical. Alternative assessment measure students' understanding of content more thoroughly and completely than multiple-choice retention tests (Gardner, 1983; Armstrong, 1994).

2.9 Summary of the Literature Review

The investigations about science and technology education continues dependent on the economic and technological changes of the modern world. As a result of these investigations, the philosophy that less is more, a set of essential and enduring concepts that provide a solid base for further learning were determined. The studies of curricula development in Turkey has begun after the foundation of the Republic. The agreement of the law of United Instruction (Tevhid-i Tedrisat) and gathering all the curricula studies under the responsibility of National Education Ministry were the first steps.

Turkey was influenced due to the changes in the world and 2004 Science and Technology curricula, which was declared as 2004 primary school curricula in August 2004 by Turkish Minister of Education, was tested in 120 schools representing the population of Turkey in 2004-2005 academic year. Then, it has

been implemented throughout the country since 2005- 2006 academic year on account of the successful results.

The main philosophy of 2004 curricula is told to be constructivism. One of the results of recent researches reveals that constructivist approach suggesting student-centered education is effective on science education. Constructivist approach requires teachers and experts developing curricula to understand its objectives. Note that the role of teaching is not to lecture and impart knowledge, but to direct student activity to discover their own knowledge. The classroom consists of a "social environment". The vision of Science and Technology curricula is expressed as "...making all the students science and technology literate people no matter what the individual differences they have" There are four groups of learning goals regarding with knowledge, science-technology-society-environment, scientific thinking skills, and attitude and values. In the curricula, not only knowledge but also skills, values and attitudes are included when writing the learning objectives and their relationships are stated in the document explaining the organization of each unit.

Constructivism can be defined as programs that are student-centered and are based on a theory of learning that focuses on how students develop understandings.

Performance based assesment, parental involvement, student's perception of classroom learning environment, school resources, class size and teacher qualification are some of the factors affecting the science achievement.

Students' attitudes towards science are more positive when they engage in behaviors such as choosing problems and finding solutions to those problems (student-centered), working in large and small cooperative groups, performing hands-on science laboratory experiences and learning through conceptual understanding rather than memorization.

Alternative assessment tools can successfully measure skills. These tools are performance-based assessments, projects, peer or self-designed instruments, interviews, journals, portfolios, concept maps, teacher observations and questioning techniques.

The reviewed literature has led several researches on methods of science education, evaluation and new ideas about testing methodology in science. In this thesis, the effects of 2004 science and technology curricula will be searched.

CHAPTER 3

METHOD

In this part of this thesis research description of population and sampling, instruments used, variables, validity and reliability and procedure were discussed.

3.1 Population and Sample

In this study the sample is 290 seventh grade students from six different elementary public schools in Ankara. The study was conducted in 2006-2007 spring term. Two schools represent the schools in pilot group in which students had science education with 2004 science and technology curricula. These two schools were chosen from the 25 pilot schools in Ankara. The other four schools represent the schools in control group in which the 2002 science curricula was applied.

Convenience sampling was used to obtain a representative sample of pilot schools. First the district was chosen by the convenience sampling method and all schools were selected conveniently with the consideration of being close to each other. Six schools are in the region of Yenimahalle, Sincan and Mamak. While assigning the groups demographic characteristics, gender were taken into account. Also convenient classes, administrations and teachers were chosen. The number of the students in pilot and control groups was given in Table 3.1.

Table 3.1 The number of the students in pilot and control groups

Pilot Group	112
Control Group	178
Total	290

In Table 3.2 the distribution of students in each school is given. The gender distribution of students is shown in Table 3.3 The gender distribution of students in pilot and control groups.

Table 3.2 The distribution of students in each school

School	Frequency	Percent	Cumulative Percent
1,00	62	21,4	21,4
2,00	50	17,2	38,6
3,00	44	15,2	53,8
4,00	41	14,1	67,9
5,00	49	16,9	84,8
6,00	44	15,2	100,0
Total	290	100,0	

In order to understand if these two groups were equivalent, some additional analyses were carried out by the use of the responses of students on some of the questionnaire items used in the Teachers' Classroom Activities Scale (TCAS).

This questionnaire included questions about (a) gender; (b) attendance to school (c) personal science study hours; (d) parental education level (father education level, mother education level); (e) number of books at home; (f) house assets (computer at home, private room at home, private study table at home, dictionary at home, encyclopedia at home, experiment kit at home, washing machine at home); (g) number of people at home. The pilot and control groups were compared with respect to these questions.

Table 3.3 The gender distribution of students in pilot and control groups

		boy	girl
Pilot Group	f	57	55
	%	50,9%	49,1%
Control Group	f	82	96
	%	46,1%	53,9%
Total	f	139	151
	%	47,9%	52,1%

Chi- square tests are conducted to understand whether there are significant differences between the two groups of the students on the seven items. We can see from Table 3.4 that, no chi-square value is not significant. This means that there are no significant differences between two groups of the students on the seven characteristics. We can say that pilot group and the control group are equal in terms of gender, attendance to school, personal science study hour, parental education level, number of books at home, house assets and number of people at home.

Table 3.4 Chi-Square Values

Item	Pearson Chi-Square Value	df	p
1. Gender	0,641	1	0,443
2. Attendance to school	2,171	2	0,338
3. Personal Science Study Hours	6,659	3	0,084
4. Father Education Level	12,149	5	0,33
5. Mother Education Level	7,937	5	0,16
6. Number of books Computer at home	4,265	3	0,234
Private room at home	0,191	1	0,662
Private study table at home	0,233	1	0,629
Dictionary at home	2,525	1	0,324
Encyclopedia at home	7,525	1	0,621
Experiment Kit at home	3,602	1	0,058
Washing machine at home	3,847	1	0,625
Dishwasher at home	0,522	1	0,479
7. Number of people at home	1,119	1	0,290
	6,774	4	0,148

These students' sixth grade science course marks were also compared across pilot and control groups.

It is given in Table 3.5. The Analysis of the Students' Six Grade Level Science Marks. The result of the t-test was not significant, $t(288) = -1,312$, ($p = ,190$). We don't have enough evidence to conclude that there is a significant mean difference between the pilot and control groups' mean science course grades in the previous year.

Table 3.5 The Analysis of the Students' Sixth Grade Level Science grades

Groups	N	Mean	S	df	t-value	p
Pilot Group	112	2,68	,60	288	-1,312	,190
Control Group	178	2,76	,46			

3.2 Variables

There were 17 variables as dependent and independent variables.

3.2.1 Dependent Variables

In this study four different measuring tools, 12 dependent variables were considered.

3.2.1.1 The Dependent Variables for Science Achievement Tests

- i. Science Achievement Scores from knowledge and understanding level part of Science Achievement Test (SATKUL)
- ii. Science Achievement Scores from higher order thinking skills part of Science Achievement Test (SATHOTS)

3.2.1.2 The Dependent Variables for the Test of Science Related Attitudes

The five dependent variables for the Test of Science Related Attitudes were the scores of the students from the five categories of the Test of Science Related Attitudes, which are:

- i. Students' Test of Science Related Attitudes Career Interest in Science Scores (TOSRACISS)
- ii. Students' Test of Science Related Attitudes Leisure Interest in Science Scores (TOSRALISS)
- iii. Students' Test of Science Related Attitudes Social Implication of Science Scores (TOSRASISS)
- iv. Students' Test of Science Related Attitudes Enjoyment of Learning in Science Lesson Scores (TOSRAELSS)
- v. Students' Test of Science Related Attitudes Scientist Lifestyle Scores (TOSRASLS)

3.2.1.3 The Dependent Variables for the Teachers' Classroom Activities Scale

The five dependent variables for the Teachers' Classroom Activities Scale were the scores of the students from the five categories of the Teachers' Classroom Activities Scale, which are:

- i. Students' Teachers' Classroom Activities Scale Scores from the Classroom Activities of 2004 Approach category (CANATCAS).
- ii. Teachers' Classroom Activities Scale Scores from the Care of Teacher category (COTTCAS).
- iii. Students' Teachers' Classroom Activities Scale Scores from the Use of Equipment by teachers category (UETCAS).
- iv. Students' Teachers' Classroom Activities Scale Scores from the Classical Classroom Activities Category (CCATCAS).
- v. Students' Teachers' Classroom Activities Scale Scores from the Processing the Subject category (PSTCAS).

3.2.2 Independent Variable

The school types of the subject were the independent variables of this research. 1 represents the schools in pilot group in which students had science education with 2004 science and technology curricula. 2 represents the schools in control group in which the 2002 science curricula was applied.

3.3 Instruments Used

In this study four instruments: Science Achievement Test, Test of Science Related Attitudes and Teachers' Classroom Activities Scale were administered to the seventh grade students. Static-group comparison design was used with these measuring tools as post tests.

Before the application of the tests all the students have finished the subjects in the science curricula. One lecture hour for the Science Achievement Test and

one lecture hour for the other three instruments were given. So all the students were able to complete solving the items in two lecture hours. All the teachers applying the instruments followed the examination rules.

3.3.1 Science Achievement Test

There were 26 multiple choice questions (See Appendix A) covering the four main content domains: chemistry, earth science, environmental science and physics. The main topics are The Space Puzzle, Human and Environment, Structure of Matter, Force and Motion, Electricity in Our Lives. The objectives of the questions according to 2004 curricula is given in Appendix C (See Appendix C). The questions were settled in terms of cognitive domain of Bloom's Taxonomy. A table of specification (See Appendix B) showing the levels of the questions was planned. 15 of the questions were referring to knowledge and understanding level (SATKUL) while 11 were higher order thinking skills level (SATHOTS). There was only one booklet of SAT. There weren't any interaction between the students during the test.

The achievement test questions administered on students were selected from TIMMS science achievement tests and the researchers own questions properly to the test plan. The questions include the common objectives of both new and 2002 curricula.

The 18 items of the science achievement test were taken from TIMMS Science achievement tests. The researcher wrote 8 questions after a wide literature review and using the items asked in TIMMS, PISA and OKS. The questions were checked by a master student from the measurement and evaluation department and by a mathematics teacher who is the writer of Ministry of National Educations' Mathematics 4 and 5 text books. They controlled the items according

to 2004 curricular objectives and test formats. A science course teacher, an English teacher and a Turkish Literature teacher checked all the items and translations. These 8 items were also published in Fen ve Teknoloji 4 Geliştiren Etkinlikler and Fen ve Teknoloji 5 Geliştiren Etkinlikler working books. The alpha values range from 0,54-0,82 in this study. (See Appendix B) Table of Specification of Science Achievement Test.

3.3.2 Test of Science Related Attitudes

The Test of Science Related Attitudes (TOSRA) (See Appendix D) questionnaire is designed to measure science-related attitudes of students in middle and high schools. The final version of TOSRA contained 70 items which were arranged into seven subscales namely: social implication of science, scientist lifestyles, attitudes toward inquiry, adaptation of scientific attitudes, enjoyment in science learning in science learning lessons, leisure interest in science, and career interest in science. The final version of the TOSRA has subscale reliabilities ranging from 0.67 to 0.93 (mean 0.80) and reliability of the instrument is 0.78 (Fraser, 1978).

The TOSRA is a multidimensional instrument with strong theoretical Foundation (Smist & Owen, 1994). In addition, Schibeci et al. (1982) compared this test with a semantic differential instrument and concluded that the TOSRA was more effective in measuring specific attitudes than open-ended questions. The instrument was firstly validated in Australia and involved 1337 students' grades 7-10 from 11 different schools in 1977. Since that time, cross-validation data from new samples of secondary science classes in Australia and the United States have become available. For instance, Khalili (1987) investigated the TOSRA for crosscultural validation in USA obtaining reliabilities of 0.69 to 0.93 with median of 0.87.

Intercorrelations among TOSRA's scales were calculated as indices as discriminant validity. These intercorrelations were generally fairly low, ranging from 0.10 to 0.59 with a mean of 0.33. In addition, test re-test reliability coefficients on the seven scales range from 0.69 to 0.84. Using the Cronbach reliability alpha coefficient, the internal consistency of the scales was tested with data for grades 7-10. Alphas on the seven scales ranged from 0.66-0.93 (Fraser, 1981). The alpha values range from 0.71-0.92 in this study.

Students are asked to indicate whether they strongly agree (SA), agree (A), undecided or neutral (N), disagree (DA), or strongly disagree (SD) with each statement.

To test the construct validity of TOSRA and to find its sub categories, factor analysis was done.

Table 3.6 Varimax Rotated Factor Loadings for TOSRA

Item no	Factor1	Factor 2	Factor 3	Factor 4	Factor 5
1	,685				
2	,645		,252		
3	,641	,139			
3	,598		,228	,127	
4	,592	,194			
5	,584		,321		
6		,605	,365		,109
7		,584	,256	,120	
8		,545			

9		,514	,169	,270	,187
10		,492			,157
11	,154		,487		,351
12			,466		,333
13		,379	,435		,345
14		,167	,365		,354
15	,177		,354		
16	,123		,113	,719	,130
17	,220		,264	,656	,144
18	,133		,179	,630	,121
19	,149		100	,522	,161
20	,106	,462	,170	,508	,261
21	,166	,430			,631
22	,240	,411			,550
23			,125		,540
24			,050		,538
25			,458		,514

According to the output of the factor analysis from Table 3.6 the researcher decided that, the scale contains five sub categories. The selected scales are social implication of science, scientist lifestyle, enjoyment of learning in science lessons, leisure interest in science, and career interest in science. These scales are shown in Table 3.7.

Table 3.7 Description of Scales in the Test of Science Related Attitudes (TOSRA)

Scale Name	Description of scale	Associated items
Career Interest in Science	Students' future interest in science	1, 2, 3, 4,5
Leisure Interest in Science	Students' desire to participate in out of school Science-related activities.	6, 7, 8, 9,10
Social Implication of Science	Students' attitude regarding the positive and negative effects of science society	11, 12, 13, 14, 15
Enjoyment of Learning Science	Students' level of enjoyment in science learning	16, 17, 18, 19,20
Scientist Lifestyle	Belief about scientist lifestyles	21, 22, 23, 24, 25

Chaerul (2002) design a short version of the TOSRA, applied the questionnaire in Senior high school students; five items from each scale were dropped. Squared Multiple Correlation and Alpha If Item Deleted were considered as a means to select five designated items. Alphas on the five scales ranged from 0.79-0.84. Five out of seven, scales social implication of science, scientist lifestyle, enjoyment of learning in science lessons, leisure interest in science, and career interest in science. This short form of TOSRA were used in this research.

This questionnaire was translated into Turkish by Fulya Cürebal and checked by foreign language specialists and professors from METU and Bosphorus University (Cürebal, 2004).

The final version of the TOSRA has subscale reliabilities ranging from 0.67 to 0.93 (mean 0.80) and reliability of the instrument is 0.78 (Fraser, 1978). For instance, Khalili (1987) investigated the TOSRA for cross-cultural validation in USA obtaining reliabilities of 0.69 to 0.93 with median of 0.87.

3.3.3 Teachers' Classroom Activities Scale

Teachers' Classroom Activities Scale (See Appendix F) was a scale developed by Pekiner (2007) to assess dimensions through 45 items. The items were rated on 5 point response. To test the construct validity of TCAS and to find its sub categories the researcher made the factor analysis. (Table 3.8)

Table 3.8 Varimax Rotated Factor Loadings for TCAS

Item no	Factor1	Factor 2	Factor 3	Factor 4	Factor 5
22	,780				
23	,762		,252		
27	,760	,139			
21	,757		,228	,127	
26	,730	,194			
19	,685		,321		
12	,605	,123	,365		,109
20	,594	,220	,256	,120	
25	,545	,133			
37	,504	,149	,169	,270	,187

28	,492	,106			,157
33	,487				,351
35	,466		,153		,333
41	,435	,379	,104		,345
42	,365	,167	,131		,354
3	,177	,719	,171		
5		,656	,113	-,104	-,130
6		,630	,264		,144
9		,522	,179		,121
1	,444	,508	,100	-,245	-,161
10	,232	,462	,170	-,149	,261
8	,166	,430			,331
2	,240	,411			,150
14		,414	,371	,179	,247
11	-,187	,361	,200	,198	,244
44		,289	,236		,138
16	,329		,533	-,123	
18	,284		,510	,111	,204
7	,130	,424	,498		-,246
15	,465	,138	,475	,260	
13	,243	,194	,445	-,138	,132
17	,435		,423		,243
43	,171		,335		,248
39	-,215	,126	,138	,708	,136
29	,160		-,350	,552	
45		-,126	,111	,532	
38	-,161	,166	,455	,520	
32			,171	,519	,159
36	,147	-,172		,514	
24	,281	-,108	-,186	,500	-,137

30	,338		-,174	,469	,276
31				,191	,682
34			,119		,532
4	,294	,338	,330		-,413
40	,303	,228	,159	,112	,374

The higher scores mean the higher frequency of the teachers' applications while the lower scores mean lower frequency of the teachers' activities. According to the output of the factor analysis from Table 3.8 it was decided that, the scale contains five sub categories; Classroom Activities of New Approach category (CANATCAS), Care of Teacher category (COTTCAS), Use of Equipment by teachers category (UETCAS), Classical Classroom Activities Category (CCATCAS), Processing the Subject category (PSTCAS). According to the principal components factor solution with varimax rotation, the first five eigenvalues were 10.2, 3.6, 2.7, 1.98, and 1.78. The Distribution of the Items are given in Table 3.9

Reliability analyses were performed for the Teachers' Classroom Activities Scale scores. The value of alfa was 0.90 for the TCAS. This means that scores obtained on the TCAS are reliable. The alpha values range from 0,65-0,91 in this study.

Table 3.9 The Distribution of the Items in the Teachers' Classroom Activities Scale

Scale Name	Associated items
Classroom Activities of the New Approach category (CANATCAS)	12,19,20,21,22,23,25,26,27,28,33,35,37,41,42
Classroom Activities Scale Scores from the Care of Teacher category (COTTCAS)	1,2,3,5,6,8,9,10,11,14,44
Classroom Activities Scale Scores from the Use of Equipment by teachers category (UETCAS)	7,13,15,16,17,18,43
Classroom Activities Scale Scores from the Classical Classroom Activities Category (CCATCAS)	24,29,30,32,36,38,39
Classroom Activities Scale Scores from the Processing the Subject category. (PSTCAS)	4,31,34,40

3.4 Analysis of the data

Data were analyzed by researcher by using Excel and SPSS. The data obtained from the study was analyzed in terms of descriptive statistics and inferential statistics by using multivariate analysis of variance (MANOVA).

CHAPTER 4

RESULTS

In this chapter there are four sections. First section is the missing data analysis, second is the descriptive statistics of the data obtained from Science Achievement Test, Teachers' Classroom Activities Scale, Learning Style Inventory and Test of Science Related Attitudes. The third section is the inferential statistics and the fourth is the findings of these statistics.

4.1 Missing Data Analysis

The missing responses in Science Achievement Test are accepted as wrong. In Teachers' Classroom Activities Scale's missing data is smaller than 5% of the whole data so mean replacement was carried out for the missings of this particular questionnaire. In Test of Science Related Attitudes there were no missing data obtained.

4.2 Inferential Statistics

Multivariate analysis of variance (MANOVA) is used to test the hypothesis and find the relationship between dependent and independent variables. In rejecting the true null hypothesis the probability is 0.05 (Type 1-error).

4.2.1 Science Achievement Test

In order to see the mean difference of students' knowledge and understanding level SATKUL and higher order thinking skills SATHOTS in the Science Achievement Test with respect to 2004 curricula versus 2002 curricula, MANOVA test is used.

Multivariate normality, equality of variances and independency of observations are the assumptions of MANOVA (Stevens, 2002).

The skewness and kurtosis values are acceptable values. So we can assume that data have multivariate normality in the score distribution. The homogeneity of variance covariance matrices is the second assumption. The assumption is the equality of variance covariance matrices across groups. We use Box's Test. In Table 4.1 it is seen that $p < ,05$ ($p=,029$), so the assumption is not met. It is very unlikely that the equal covariance matrices assumption would ever literally be satisfied in practice (Stevens, 2002).

Table 4.1 Box's Test Equality of Variance Covariance Matrices of SAT

Box's M	45,022
F	1,563
df1	28
df2	196118,9
Sig.	,029

Levene's Test of Equality of Error Variances of SAT is found to determine the equality of variances (Table 4.2). The error variances are equal for both SATKUL and SATHOTS.

Table 4.2 Levene's Test of Equality of Error Variances of SAT

	F	df1	df2	Sig
SATKUL	3,777	1	288	,053
SATHOT	,671	1	288	,076

In Table 4.3 we can say that SCHOOL type is explaining %24.8 variance of model for the dependent variables of the SATKUL and SATHOTS.

Table 4.3 Multivariate Tests of SAT

Effect	Wilks' Lambda	F	df	Error df	Sig	Eta Squared	Observed Power
SCHOOL	,752	,149	7	282,0	00	,248	1,000

Null Hypothesis:

There is no significant difference in the mean science achievement scores of students across 2004 and 2002 curricula in the knowledge and understanding level learning outcomes and higher order thinking skills level outcomes.

This null hypothesis is rejected (Table 4.3). This means that there is significant difference in the mean science achievement scores of students across 2004 curricula and 2002 curricula in the knowledge and understanding level learning outcomes and higher order thinking skills level outcomes: $F(7, 282) = ,149$ ($p = ,00$).

To find the effect of independent variable SCHOOL on each dependent variable tests of between subjects effects are used. As it is shown in Table 4.4, there is a significant difference in the mean science achievement scores of

students across 2004 and 2002 curricula in the knowledge and understanding level learning outcomes: ($p=,00$). On the other hand there is no significant difference in the mean science achievement scores of students across 2004 and 2002 curricula in the higher order thinking skills level outcomes ($p=,697$).

Table 4.4 Tests of Between-Subjects Effects of SAT

Source	Dependent Variable	Type III Sum of Squares	df	Mean Square	F	Sig.	Eta Squared	Observed Power
SCHOOL	SATKUL	49	1	49	,673	,00	,19	1,000
	SATHOTS		1		,152	,697	,001	,068

In Table 4.5 Estimated Marginal Means is given for SAT. We can conclude that the difference on students SATKUL scores is in favor of control group. The students in control group had significantly higher mean of SATKUL scores than the students in pilot group.

Table 4.5 Estimated Marginal Means of SAT

Dependent Variable	SCHOOL	Mean	S.D.
SATKUL	Pilot Group	69,8	,08
	Control Group	78,2	,06
SATHOTS	Pilot Group	27,4	,024
	Control Group	26,1	,019

As a result there is a significant difference in the mean science achievement scores of students knowledge and understanding level learning outcomes in favor of the 2002 curricula.

4.2.2 Test of Science Related Attitudes

In order to see the mean difference of students' Career Interest in Science TOSRACIS, Leisure Interest in Science TOSRALIS, Social Implication of Science TOSRASIS, Enjoyment of Learning in Science Lesson TOSRAELS, Scientist Lifestyle TOSRASL scores in Test of Science Related Attitudes with respect to 2004 curricula versus 2002 curricula, MANOVA test is used. Multivariate normality, equality of variances and independency of observations are the assumptions of MANOVA. The skewness and kurtosis values are acceptable values. So we can assume that data have multivariate normality in the score distribution.

The homogeneity of variance covariance matrices is the second assumption. The assumption is the equality of variance covariance matrices across groups. We use Box's Test. In Table 4.6 it is seen that $p < ,05$ ($p=,017$), so the assumption is not met. It is very unlikely that the equal covariance matrices assumption would ever literally be satisfied in practice (Stevens, 2002).

Table 4.6 Box's Test Equality of Variance Covariance Matrices of TOSRA

Box's M	26,295
F	2,759
df1	14
df2	452116
Sig.	,017

In Table 4.7 Levene's Test of Equality of Error Variances of TOSRA is found to determine the equality of variances. The error variances are equal for TOSRACIS, TOSRALIS, TOSRAELS, TOSRASL but not equal for TOSRASIS.

Table 4.7 Levene's Test of Equality of Error Variances of TOSRA

	F	df1	df2	Sig
TOSRACIS	,005	1	288	,943
TOSRALIS	1,09	1	288	,316
TOSRASIS	5,045	1	288	,025
TOSRAELS	,016	1	288	,899
TOSRASL	2,542	1	288	,112

The third assumption is that each one of the students answered the items by themselves. In Table 4.8 we can say that SCHOOL type is explaining %4,5 variance of model for the dependent variables of TOSRACIS, TOSRALIS, TOSRAELS, TOSRASL, TOSRASIS.

Table 4.8 Multivariate Tests of TOSRA

Effect	Wilks ' Lamb da	F	Hypothesis df	Error df	S i g	Eta Squ are d	Observed Power
SCHOOL	,832	2,56	6	467,00	,00	,045	,095
		6			0		
		9			1		

Null Hypothesis:

There is no significant difference in the mean scores of students across 2004 curricula and 2002 curricula in the attitude towards science.

The null hypothesis is rejected as it is given in Table 4.9. This means that there is significant difference among teaching science across 2004 and 2002 curricula in terms of the students attitudes towards science on the dependent variables career interest, leisure interest, social implication, enjoyment in science

learning and scientist lifestyle: $F(6,467) = 2,569$ ($p = ,01$). To find the effect of independent variable SCHOOL on each dependent variable tests of between subjects effects are used. In Table Table 4.9 Tests of Between-Subjects Effects of TOSRA are given.

As it is shown in Table 4.9, there is no significant difference among teaching science across 2004 and 2002 curricula in terms of the students attitudes towards science on the dependent variable career interest: ($p = ,177$).

There is significant difference among teaching science across 2004 and 2002 curricula in terms of the students attitudes towards science on the dependent variable leisure interest ($p = ,018$).

Table 4.9 Tests of Between-Subjects Effects of TOSRA

Source	Dependent Variable	Type III Sum of Squares	df	Mean Square	F	Sig.	Eta Squared	Observed Power
SCHOOL	TOSRA CIS	,411	1	,411	1,828	,177	,006	,271
	TOSRA LIS	1,528	1	1,528	5,614	,018	,019	,656
	TOSRA SIS	8,768E-02	1	8,768E-02	,335	,563	,001	,089
	TOSRA ELS	4,634	1	4,634	12,871	,000	,043	,947
	TOSRA SL	1,415	1	1,415	3,631	,058	,012	,476

On the other hand there is no significant difference among teaching science across 2004 and 2002 curricula in terms of the students attitudes towards science on the dependent variable social implication: ($p = ,563$).

There is significant difference among teaching science across 2004 and 2002 curricula in terms of the students attitudes towards science on the dependent variable enjoyment of learning in science lesson: ($p=,000$).

There is no significant difference among teaching science across 2004 and 2002 curricula in terms of the students attitudes toward science on the dependent variable scientist lifestyle: ($p=,058$).

In Table 4.10 Estimated Marginal Means of TOSRA is given. We can conclude that the difference on students TOSRALIS scores is in the favor of pilot group. The students in pilot group had significantly higher means of TOSRALIS scores than the students in control group. We can also conclude that the difference on students TOSRAELS scores is in the favor of control group. The students in control group had significantly higher means of TOSRAELS scores than the students in pilot group.

Table 4.10 Estimated Marginal Means of TOSRA

Dependent Variable	SCHOOL	Mean	S.D.
TOSRACIS	Pilot Group	2,936	,045
	Control Group	2,858	,036
TOSRALIS	Pilot Group	2,984	,049
	Control Group	2,835	,039
TOSRASIS	Pilot Group	2,764	,048
	Control Group	2,800	,038
TOSRAELS	Pilot Group	3,179	,057
	Control Group	3,438	,045
TOSRASL	Pilot Group	3,516	,059
	Control Group	3,660	,047

As a result there is a significant difference in the mean science attitude scores of students leisure interest outcomes in the favor of 2004 curricula and there is a significant difference in the mean science attitude scores of students enjoyment in science learning outcomes in the favor of the 2002 curricula.

4.2.3 Teachers' Classroom Activities Scale

In order to see the mean difference of students' Classroom Activities of 2004 Approach category (CANATCAS), Care of Teacher category (COTTCAS), Use of Equipment by teachers category (UETCAS), Classical Classroom Activities Category (CCATCAS), Processing the Subject category (PSTCAS) scores in Teachers' Classroom Activities Scale with respect to 2004 curricula versus 2002 curricula, MANOVA test is used.

Multivariate normality, equality of variances and independency of observations are the assumptions of MANOVA. The skewness and kurtosis values are acceptable values. So we can assume that data have multivariate normality in the score distribution. The homogeneity of variance covariance matrices is the second assumption. The assumption is the equality of variance covariance matrices across groups. We use Box's Test. In Table 4.11 it is seen that $p < ,05$ ($p=,00$), so the assumption is not met.

Table 4.11 Box's Test Equality of Variance Covariance Matrices of TCAS

Box's M	164,785
F	6,963
df1	26
df2	265743
Sig.	,000

In Table Table 4.12 Levene's Test of Equality of Error Variances of TCAS is found to determine the equality of variances. The error variances are equal for UETCAS but not equal for CANATCAS, COTTCAS, CCATCAS and PSTCAS.

The third assumption is that each one of the students answered the items by themselves. In Table 4.13 we can say that SCHOOL type is explaining %24,3 variance of model for the dependent variables of CANATCAS, COTTCAS, UETCAS, CCATCAS, PSTCAS.

Null Hypothesis:

There is no significant difference in the mean scores of students across 2004 and 2002 curricula in the teachers' classroom activities scale.

Table 4.12 Levene's Test of Equality of Error Variances of TCAS

	F	df1	df2	Sig
CANATCAS	37,467	1	288	,000
COTTCAS	70,410	1	288	,000
UETCAS	1,504	1	288	,221
CCATCAS	5,622	1	288	,018
PSTCAS	59,177	1	288	,000

The null hypothesis is rejected as it is given in Table 4.13. This means that there is significant difference among teaching science across 2004 and 2002 curricula in terms of the students TCAS scores on the dependent variables: $F(10,580) = 21,356$ ($p = ,00$).

Table 4.13 Multivariate Tests of TCAS

Effect	Wilk's Lambda	F	Hypothesis df	Error df	Sig.	Eta Squared	Observed Power
SCHOOL	,624	21,356	10,000	580,000	,000	,243	1,000

To find the effect of independent variable SCHOOL on each dependent variable tests of between subjects effects are used. In Table Table 4.14 Tests of Between-Subjects Effects are given.

Table 4.14 Tests of Between-Subjects Effects of TCAS

Source	Dependent Variable	Type III Sum of Squares	df	Mean Square	F	Sig.	Eta Squared	Observed Power
SCHOOL	CANA TCAS	2,376	1	2,376	5,274	,022	,018	,629
	COTT CAS	,639	1	,639	1,729	,190	,006	,259
	UETCAS	6,432	1	6,432	19,604	,000	,064	,993
	CCAT CAS	8,215 E-02	1	8,215 E-02	,481	,489	,002	,106
	PSTCAS	2,979 E-02	1	2,979 E-02	,075	,784	,000	,059

As it is shown in Table 4.14, there is significant difference among teaching science across 2004 and 2002 curricula in terms of the students TCAS scores on

the dependent variable Classroom Activities of New Approach category (CANATCAS) : ($p=,022$).

There is no significant difference among teaching science across 2004 and 2002 curricula in terms of the students TCAS scores on the dependent variable Care of Teacher category (COTTCAS) ($p=,190$).

There is significant difference among teaching science across 2004 and 2002 curricula in terms of the students TCAS scores on the dependent variable Use of Equipment by teachers category (UETCAS): ($p=,000$).

There is no significant difference among teaching science across 2004 and 2002 curricula in terms of the students on TCAS scores the dependent variable Classical Classroom Activities Category (CCATCAS): ($p=,489$).

There is no significant difference among teaching science across 2004 and 2002 curricula in terms of the students on the dependent variable Processing the Subject category (PSTCAS): ($p=,784$).

In Table 4.15 Estimated Marginal Means of TCAS is given. We can conclude that the difference on students CANATCAS scores is in the favor of control group. The students in control group had significantly higher means of CANATCAS scores than the students in pilot group. We can also conclude that the difference on students UETCAS scores is in the favor of pilot group. The students in pilot group had significantly higher means of UETCAS scores than the students in control group.

Table 4.15 Estimated Marginal Means of TCAS

Dependent Variable	SCHOOL	Mean	S.D.
CANATCAS	Pilot Group	3,477	,063
	Control Group	3,663	,050
COTTCAS	Pilot Group	2,683	,057
	Control Group	2,780	,046
UETCAS	Pilot Group	4,531	,054
	Control Group	4,225	,043
CCATCAS	Pilot Group	2,628	,039
	Control Group	2,662	,031
PSTCAS	Pilot Group	2,504	,060
	Control Group	2,525	,047

As a result there is a significant difference in the mean of TCAS scores of Use of Equipment by teachers category outcomes in the favor of 2004 curricula and there is a significant difference in the mean of TCAS scores of Classroom Activities of New Approach category outcomes in the favor of the 2002 curricula.

4.3 Summary of Results

4.3.1 Results of SAT

A) There is a significant difference in students' knowledge and understanding level learning outcomes in the favor of the 2002 curricula.

B) There is no significant difference in students' higher order thinking skills level outcomes between 2004 and 2002 curricula.

4.3.2 Results of TOSRA

A) There is no significant difference in students' career interest outcomes between 2004 and 2002 curricula.

B) There is a significant difference in students' leisure interest outcomes in the favor of 2004 curricula.

C) There is a significant difference in students' enjoyment of learning in science lesson outcomes in the favor of the 2002 curricula.

D) There is no significant difference in students' social implication of science outcomes between 2004 and 2002 curricula.

E) There is no significant difference in students' scientist lifestyle outcomes between 2004 and 2002 curricula.

4.3.3 Results of TCAS

- A) There is a significant difference in Use of Equipment by teachers category outcomes in the favor of 2004 curricula.

- B) There is a significant difference in Classroom Activities of New Approach category outcomes in the favor of the 2002 curricula.

- C) There is no significant difference in Care of Teacher category outcomes between 2004 and 2002 curricula.

- D) There is no significant difference in Classical Classroom Activities category outcomes between 2004 and 2002 curricula.

- E) There is no significant difference in Processing the Subject category outcomes between 2004 and 2002 curricula.

CHAPTER 5

CONCLUSIONS, DISCUSSIONS AND IMPLICATIONS

5.1. Summary of the Research Study

The purpose of this study is to investigate the effects of 2004 elementary science and technology curricula on 7th grade students. For the purpose, (1) the effects of 2004 curricula on the achievement of the students considering knowledge and understanding and higher order thinking skills, (2) the effects on the students' attitude to science and technology (3) the effects on teachers classroom activities were investigated. Science Achievement Test (SAT), The Test of Science Related Attitudes (TOSRA) and Teachers' Classroom Activities Scale (TCAS) were applied as post tests.

The groups used for this study were not randomly equivalent groups, so that some additional analyses were carried out in order to see if there were differences across the pilot and control groups with respect to several student characteristics. The analyses indicated that groups have the similar characteristics in terms of gender, attendance, science study hours and socio economic status and previous science achievement. However, the representativeness of the samples is still questionable to generalize the results to the whole Turkish population at this particular grade level.

5.2 Conclusions and Discussions

The Ministry of Education has changed the elementary school education curricula and also the name 'Science Course' into 'Science and Technology Course' in the beginning of the 2004-2005 semesters. It was applied in 6 cities at 104 pilot schools. In 2005-2006 academic year, recent curricula has begun to be practiced officially from 1st class to 5th class in all schools. The textbooks were written in line with the objectives of the new curricula. In 2006-2007 academic year the curricula was tested on 7th grade students at certain schools. Thus, the present study focused on 7th graders to compare the outcomes of the new curricula with respect to the previous one.

2004 science and technology curricula is developed according to the innovations in the modern science education. Its philosophy and content have been written in detail when they are compared with 2002 curricula. We can say that 2004 curricula's approaches and techniques have generally at the expected standarts. However, in general no major difference was found in favor of the new curricula over the previous one. The students who were instructed with respect to the objectives of 2002 and 2004 curricula had similar mean scores. This finding strongly implies that there is a problem in the implementation of the program. On the other hand, as it was discussed before, the objectives of the new science and technology curricula were not defined with respect to higher order cognitive processes, and the subject matter emphasize was observed almost in all the units (Cito Türkiye Bilim Kurulu, 2008). This might be creating an ambiguity among teachers and textbook writers in developing science process skills.

In the study, the students science achievement is evaluated according to their knowledge and understanding and higher order thinking skills levels. The mean of knowledge and understanding level scores of the students who are instructed with the 2002 curricula content is higher than the mean scores of the students who are

instructed with 2004 science and technology curricula. This might be the results of subject matter emphasize of the 2002 curricula. On the other hand, when the student's higher order thinking level outcomes are compared, there is no significant difference between the two groups. This result might be due to several different reasons.

Most of the 2004 curricula content can not be practiced and instructed at the higher order thinking skill level by the science teachers in the classroom. The instruction steps given in the curricula are probably not followed, the teachers aren't good at applying the new techniques. When 2004 curricula was piloted in 120 schools, it was observed that the students were mostly in an undisciplined and disorganized situation in the classrooms.

Although 2004 elementary science instruction curricula emphasizes on the students' higher order thinking skills in science, it couldn't reach its aim. There is a problem about consistency and validity in 2004 elementary science instruction curricula. The inconsistency is between the general goals and objectives and also between the objectives and activity examples. The objective statements and activities which are considered to be appropriate to the objective, don't overlap with each other in the view of content. Even if the general structure of 2004 curricula is defined well, the relations between objective statements and the general structure is not (Berberoğlu, G. , Arıkan, S. , Demirtaşlı N. , Güzel Ç.İ. , Tuncer Ç.Ö. , 2009)

With respect to attitudinal dimension similar mean scores in Career Interest, Social Implication of Science and Scientist lifestyle were obtained between the experimental and control groups. We can say that 2004 science and technology curricula doesn't have any effect on the students' career interest, social implication of science and scientist lifestyle when compared with the 2002 curricula. There is a significant difference of students' leisure interest outcomes in the favor of 2004 curricula while there is a significant difference of students'

enjoyment of learning in science lesson outcomes in the favor of the 2002 curricula.

One of the important aims of science education in the USA is to teach "science for every one and to create scientifically literate citizens", according to the National Science Education Standards in the USA (1996), but escaping from science classes is still the norm world wide. For example, Baykul (1990) found that Turkish students' attitudes toward science and mathematics courses substantially decreased from grade 5 through grade 11. It seems that there is still problem in developing positive attitudinal changes via the new science curricula.

In terms of students' attitude of working in a science laboratory after their graduation the new curricula did not make any difference over the 2002 science curricula.

One of the educational goals of the new curricula is "awareness of career options regarding with science and technology and using relevant knowledge and skills to improve economic productivity." The students haven't reached this goal yet. In order to reach this goal students should learn how to make an experiment step by step and how to analyse the results in the science laboratories. They should have the chance of inventing new things in the laboratory. This brings the importance of science process skills, however, as reported before the new curricula did not improve these skills over the 2002 curricula yet.

The leisure interest activities of the students have increased with 2004 science and technology curricula when compared with the 2002 curricula. The students are less bored while listening scientific programmes on the radio, they mention more about science subjects with their friends, they watch more TV programmes about technology and they like using scientific appliances more. With 2004 curricula, watching scientific documentaries and films in the

classroom, doing performance duties and project homeworks are the scientific events of students' at their leisure.

We see that the social implication of science hasn't changed after 2004 curricula. 2004 curricula doesn't have any effect on the interaction between the science and technology and the social life. The attitudes of going to science museums, reading scientific newspapers and articles, attending to projects, researchings are similar as they were with in the 2002 curricula.

It is a very interesting result that the students' enjoyment of learning in science lesson who are instructed with the 2002 curricula is higher than the students who are instructed with 2004 curricula. The students find the 2002 science course more exiting, enjoyable and as a result of this they want an increase in science course hour. In 2004 curricula the science and technology course is instructed in 4 lecture hours. The students who are instructed with 2004 curricula don't want an increase in the lecture hour. In order to increase the enjoyment in science learning of the students well prepared activities and games must be applied in the classrooms. The results of the activities and games must be meaningful and applicable in the students' daily life. The students should be more active and they should have the chance of facing with the astonishing sides of the science.

2004 curricula contains chapters and objectives of 2002 curricula and also it has other different chapters. Generally 2004 curricula contains the aims of 2002 curricula. It must be noted that 2002 curricula didn't have any aims or goals contrary to 2004 curricula. Also 2002 curricula didn't include any components contrary to constructivistic approach. It can also be said that, 2002 curricula is a student-centered based curricula.

The fifth category of the students' attitudes toward science and technology was scientist lifestyle. We can say that 2004 science and technology curricula

doesn't have any effect on the students' scientist lifestyle when compared with the 2002 curricula. This is because there isn't any objective in 2004 curricula which provide information about scientists. 2004 curricula should emphasize the scientists' lives. The students should be aware of the scientists' happy and regular family life. They can do sports and love music as every normal person and they are sociable.

In the study the teacher's classroom activities are evaluated according to their Classroom Activities of 2004 Approach category (CANATCAS), Care of Teacher category (COTTCAS), Use of Equipment by teachers category (UETCAS), Classical Classroom Activities Category (CCATCAS) and Processing the Subject category (PSTCAS). The scores in Teachers' Classroom Activities Scale with respect to 2004 curricula versus 2002 curricula are examined. Whereas there is a significant difference in the Use of Equipment by teachers category outcomes in the favor of 2004 curricula, there is a significant difference in the classroom activities of new approach category outcomes in favor of the 2002 curricula. There is no significant difference in care of teacher, classical classroom activities and processing the subject category outcomes.

Teachers need to rethink their beliefs on what is worth knowing about constructive science and technology curricula and education. Successful science and technology teaching can not likely be achieved without investigation of teachers' perceptions about goals. The working universe of the research is based upon the teachers of elementary schools in fourth and fifth classes in Ankara the first and the second term of academic year 2005-2006. The subject consisted of 75 elementary school science and technology teachers. The internal consistency reliability was ".92" for the teachers' survey. Science and technology teachers showed discontent with the current status of 2004 elementary school science and technology curricula. This offers directions for revision of the goals in current science and technology curricula and education system. (Dindar, H 2003)

There is a significant difference in the Use of Equipment by teachers category outcomes in the favor of 2004 curricula. The teachers who are instructing their course with 2004 curricula are more vulnerable to use VCD, TV, computer, overhead projector, projector, pictures, colourful cardboards and pencils than the teachers who are instructing their course with the 2002 curricula. 2004 curricula has made teachers and students use technology more in the classroom. The students did their homeworks with power point programme.

The present problems of Turkish science and technology education can be designated as follows in the view of many investigations (Eşme, 2004) up to date:

1. The intensive curricula (95% of all science education program) but insufficient time allocation for science education (87 hours per year).
2. The instruction of lesson in an information level and students are in passive position (only listening and writing), teachers in active position (writing on the board and teaching in a classical way).
3. Evaluation of the lesson in information level by using multiple choice items.
4. Insufficient usage of science laboratories.

The mean of the classroom activities of new approach outcomes are higher in the 2002 curricula. The teachers who instructed with the 2002 curricula have higher mean scores in having their students study in groups, play games and use technology when compared with the teachers who instructed with 2004 curricula. The result is surprising because many classroom activities are given in 2004 curricula. Every step of each activity is written in detail. But the statistical result informs us that the activities aren't good enough. In order to solve this problem the curricula writers should focus on the activities. The activities must be at the heart of the instruction process. The results of the activities must match with the daily life. Better activities related with the three skills, Science Process Skills (SPS), Science-Technology-Society-Environment (STSE), Attitudes and Values (AV) must be put in to the curricula. The objective numbers (SPS), (STSE) and (AV) aren't given equally in the chapters. In some chapters the activities are

related only with SPS while in some other chapters the activities are related only with STSE. This inequilibrium of the number of skills must be corrected. The same types of activities were given in the curricula. But the students have different learning styles. Different type of activities must be suggested for different learning styles. The activities must be related with today's and future's technology. The activities are given in such a way that, when the teacher reads it he or she focuses on the content objectives, the three learning skills are almost omitted. To avoid this, three learning skills (SPS), (STSE) and (AV) must be given after every example activity. The corrections of the misconceptions must also be written in the activities. Alternative evaluation and measurement techniques must be added and more activities must be advised. The complex and undefined activities must be reorganized. The limitations must be reexamined and the length of the activities must be planned again according to the real lecture hours.

The roles of the teachers are identified as; “creating a supportive learning environment that helps students construct their own knowledge through inquiry, realworld exploration, and collaboration, taking into consideration of the individual differences of students, using the students' experiences, guiding the classroom activities to facilitate student learning, identifying and nurturing the scientific talent and interests of all students...” all of which imply a constructivist view of teacher role. However no clear information or way to do this is provided in the curricula documentation. (Demiraslan,Y. 2005)

There is no significant difference in processing the subject category outcomes. The teachers use the laboratory and make experiments as it was with 2002 curricula. 2004 curricula hasn't changed the routines of the teachers.

The classical classroom activities category scores show us that the teachers' classical classroom activities are continuing. 2004 curricula is supporting student

centered education not teacher centered. But the results show us that the students and the teachers are preferring teacher centered education.

There is no significant difference in care of teacher outcomes. The teachers' care hasn't changed when they instruct with 2004 curricula. This means that the teachers who are instructing with 2004 curricula are giving the same importance to their students. The skills of knowing the learning styles of the students and guiding them through these styles in the classroom, repeating the blind spots, listening and appreciating the students, discussing the subjects with the students and giving enough time to think have mostly not changed.

5.3 Internal Validity of the Study

Static group comparison design provides better control over history, maturation, testing and regression threats. The main weakness of the study was subject characteristics. So while choosing the sample, subject characteristics like gender, school attendance, personal science study hours, parental education level, number of books at home, house assets and number of people at home were considered. There were no significant differences between two groups of the students on the seven characteristics. The instrument was administered to all groups in similar physical conditions of certain classrooms by the researcher. The procedure of gathering the data was performed in one day. The names of the students weren't used in anywhere.

5.4 External Validity of the Study

In this study the sample is 290 seventh grade students from six different elementary public schools in Ankara. This condition limits the generalizability of the study. The tests were applied in ordinary classrooms during the regular class time. The other external effects (noise, temperature,ect..) were sufficiently controlled.

5.5 Implications of the Study

1.The results show us that there is no significant difference between 2002 and 2004 curricularas. The reasons of changing 2002 curricula after two years should be discussed.

2.The activities can not be applied in crowded classrooms. The number of the students in the classrooms must be decreased or there should be strategies developed for conducting activities in crowded classrooms.

3.New curricula should be reorganized in a way that teachers should be able to understand and implement it properly.

4.Classroom activities suggested by new curricula should be evaluated in line with developing higher order cognitive processes.

5.Course text books should be evaluated in line with developing higher order cognitive processes.

6.They should introduce new curricula to their students and implement evaluation studies.

7. The Science Process Skills (SPS), Science-Technology-Society-Environment (STSE) and Attitudes and Values (AV) must be in focus and the students should be able to use them in their daily life.

5.6 Recommendations for Further Researches

1. Similar studies can be carried out with more students at different levels.
2. Different measurement techniques that evaluate how 2004 science and technology curricula effects students achievement and attitudes can be produced.
3. Teachers classroom activities can be examined in detail.
4. Other factors that effect students academic achievement of science and technology course can be examined.
5. Parents' approaches and thoughts for 2004 curricula and reasons of these should be researched.
6. The weak and strong sides of the curricula and the reason of the problems can be researched.
7. The missings and mistakes of the curricula content should be studied.
8. The SBS examination results of the students and 2004 curricula can be examined.
9. Textbook analyses should be carried out for investigating the congruence between content of the curricula and the textbooks.

REFERENCES

Ajzen, I. (2001). Nature and operation of attitudes. *Annual Review of Psychology*, 52, 27–58.

Association for the Advancement of Science (AAAS). (2004). Retrieved August 20, 2004, from <http://archives.aaas.org/exhibit/change.php>

Applefield, J.M., Huber, R. & Moallem, M. (2001). Constructivism in theory and practice: toward a better understanding. *The High School Journal*. Dec 2000/Jan 2001. 35-53.

Armstrong, T. (1994,). *Multiple intelligences in the classroom*. Association for Supervision and Curricula Development, Alexandria, Virginia.

Armstrong, T. (1998). Hilda Taba: Inductive thinking. Retrieved from <http://ivc.uidaho.edu/mooVniodels/tab>

Aşkar, P. & Akkoyunlu, B. (1993). Kolb öğrenme stili envanteri. *Eğitim ve Bilim*, 87(17), 37-47

- Ayaş, A., Çepni, S. & Akdeniz, A.R. (1993). Development of the Turkish secondary science curricula, *Science Education*, 77, (4), 433-440.
- Bagozzi, R. P., & Burnkrant, R. E. (1979). Attitude organization and the attitude–behavior relationship. *Journal of Personality and Social Psychology*, 37, 913–929.
- Bardeen, M., & Lederman, L. (1998). Coherence in science education. *Science*, 281 (5374), 2. Blaisdell, A. (2003). The S-R information stream: Where's the filter? *Integrative Physiological & Behavioral Science*, 38(2), 146.
- Baykul, Y. (1990). To what extent the students' attitudes towards mathematics and science subjects were changed in the Turkish schools in grades five through eleven, the factors which might have some significant relation with the student performance in student selection exam. ÖSYM Yayınları, Ankara, Turkey.
- Bayrak, B., & Erden, M. (2007). Fen bilgisi öğretim programının değerlendirilmesi, *Kastamonu Üniversitesi Kastamonu Eğitim Dergisi*, Cilt:15, No:1, s:137-154.
- Berberoğlu, G., Arıkan, S., Demirtaşlı N., Güzel Ç.İ., Tuncer Ç.Ö.,(2009), İlköğretim 1.-5. Sınıflar Arasındaki Öğretim Programlarının Kapsam ve Öğrenme Çıktıları Açısından Değerlendirilmesi *Cito Eğitim: Kuram ve Uygulama Dergisi Ocak-Şubat 2009*,. 10-48.

Betts, J. R., Zau, A. C., & Rice, L. A. (2003). New insights into school and classroom factors affecting student science achievement. Retrieved January 8, 2004, from <http://www.ppic.org>

Bevevino, M., Dengel, J., & Adams, K. (1999). Constructivist theory in the classroom: Internalizing concepts through inquiry learning. *The Clearing House*. May-June, 72 (5). 274-275.

Binbasioglu, C. (1995) Türkiye’de eğitim bilimleri tarihi (History of Turkish educational sciences). *The Series of Research and Examination*. Ankara, Turkey: MEB Publication

Bloom, B.S. (ed.) (1956). Taxonomy of educational objectives, the classification of educational goals, handbook I: Cognitive domain. David McKay Co., Inc. 204-205.

Bruner, J. (1966). *Toward a theory of instruction*. Cambridge, MA: Harvard

Carey, J. (1997). Everyone knows $E=mc^2$, now who can explain it? *Business Week*. 66, 67.

Cito Türkiye Bilim Kurulu, (2008). Milli Eğitim Bakanlığı yeni öğretim programlarının test geliştirme süreci için yapılandırılması, *Cito Eğitim: Kuram ve Uygulama Dergisi*Kasım-Aralık 2008,. 10-21.

Cürebil, F. (2004). *Gifted students attitudes towards science and classroom environment based on gender and grade level*. Retrieved January 18, 2009, from <http://library.metu.edu.tr/search/>

Demiraslan, Y. (2007). Investigating the propriety of a science and technology curricula in Turkiye , Iowa State University

Dewey, J. (1916). *Democracy and education*. The Free Press, New York. 14, 31,195, 270-271.

Dewey, J. (1916). *Democracy and education: An introduction to the philosophy of education*. New York: MacMillan

Dunn, R. (2000). Who's kidding whom? The standards won't work without learning styles. *Impact NY ASCD*. 29(2).

Dunn, R. & Griggs, S.A. (1995). Multiculturalism and learning style: Teaching and counseling adolescents. *Westport, CT: Praeger Publishers*

Emerson, R. (1876). The complete works of Ralph Waldo Emerson. New York: John Wiley,

Eşme, İ. (2004). Fen öğretiminde sorunlar (Problems in science education). *Özel Okullar Birliği Bülteni*, Maltepe University, İstanbul.

Fraser, B. J. (1978). Development of a test of science related attitudes. *Science Education*, 62. 509-515.

Fraser, B. J. (1981). Test of science related attitudes. Hawthorn, Victoria: *Australian Council for Educational Research Limited*.

Gagne, R. & Dick, W. (1983). Instructional psychology. *Annual Review of Psychology* 34, 261.

Gardner, H. (1983). Frames of mind: The theory of multiple intelligences. Harper Collins.

Gardner, H. (1999). The disciplined mind. *Basic Books*, 118-119.

Gega, P.C. & Peters, J.M. (1998). *Science in elementary education*. Merrill. 164-175.

Gill, B. (1994). Learning styles, locus of control and courseware design. Retrieved January 18, 2009, from [http://Ca/Brian/Learning Styles.html](http://Ca/Brian/Learning%20Styles.html).

Gonzalez, E. J. & Miles, J. A. (2001). TIMSS 1999 User Guide for the International Database. *International Association for the Evaluation of Educational Achievement*. Boston, MA.

Gozutok, F.D. (2003) Curricula development in Turkey. In W.F. Pinar (ed.), *International Handbook of Curricula Research*, (pp. 607-622). London: Lawrence Erlbaum

Gregorc, A. F. (1984). Learning is a matter of style. *Vocational Education*, 59(3), 27-29.

Haury, D. (1993) Teaching science through inquiry. ED 359048

Heide, C.L. (1998). Attitudes of eighth grade honors students toward the conceptual change methods of teaching science (middle school students). Doctoral dissertation, Northern Arizona University, 1998. 381.

Henson, K. (2003). Foundations for learner-centered education: *A knowledge base.Education*, 124(1), 5.

Howe, A.C. & Jones, L. (1993). Engaging children in science. (1 ed.). *MacMillan Publishing Co.*, N.Y. 8-9, 21,24,28,30,31,32,33.

Huit, W. (2000). Bloom et al.'s taxonomy of the cognitive domain. *Educational Psychology*. Retrieved January 28, 2009, from <http://chiron.valdosta.edu/whuitt/col/cogsys/bloom.html>

Johnson, S, T. (1992). Extra-school factors in achievement, attainment, and aspiration among junior and senior high school-age African American youth. *The Journal of Negro education*, 61(1), 99-119

Karagoz, S. (1965) Program geliřtirmede rehberlik (Guidance in Program Development). Ankara, Turkey: *The Publications of Teacher is at Work*.

Khalili, K. Y. (1987). A cross-cultural validation of a Test of Science Related Attitudes. *Journal of Research in Science Teaching*, 24, 127-136.

Kind, P., Jones, K. & Barmby, P. (2007) *International Journal of Science Education* Vol. 29, No. 7, 871–893 Developing Attitudes towards Science Measures

Klein, D. (2003). A brief history of American K-12 mathematics education in the 20th century. Retrieved December 26, 2002, from <http://www.csun.edu/~vcmth00m/AHistory.html>

Koc, Y. & Isiksal, M. & Bulut, S. (2008). Elementary school curricula reform in Turkey Faculty of Education, *International Education Journal*, 2007, 8(1), 30-39. Middle East Technical University, Turkey

LASER, (2004). National conference. Washington DC. Retrieved March 2, 2003, from <http://science-ed.pnl.gov/laser.stm>

Lederman, L. (2001,). Revolution in science education: Put physics first! *Physics Today*, 54(9), 11.

Lawrenz, F. (1976). The prediction of student attitude toward science from student perception of the classroom learning environment. *Journal of Research in Science Teaching*, 13, 509-515.

Lewis, P. H. (1996). Using clay to help children develop cognitive and affective skills for learning. *ERIC Document Reproduction* ED 316 326

Linn. R.L. & Miller, M.D. (2005) Measurement and Assessment in Teaching (9th edition). *Englewood Cliffs*, NJ: Prentice Hall.

Lo, L. N. (1994}. Development and education: Reflection on a contentious field of inquiry. *Chinese University Education Journal*, 21(2), 205-16.

Lorsbach, A. Tobin, K. (1997). Constructivism as a referent for science teaching. *National Association for Research in Science Teaching*. Retrieved December 26, 2007, from www.exploratorium.edu/IFI/resouix^s/research/constructivism.html.

Marzano, R.J., Pickering, D. and Tighe, J. (1993). *Assessing student outcomes: Performance assessment using the dimensions of learning model*. ASCD: Virginia, USA

Matthews, M. R. (2000). *Constructivism in Science and Mathematics Education*. Retrieved November 3, 2006, from <http://www.wcsi.unian.it/educa/inglese/matthews.html>.

McGuire, W. J. (1985). Attitude and attitude change. In G. Lindzey & E. Aronson (Eds.), *Handbook of social psychology* 233–346. New York: Random House.

MEB (2004), (Millî Eğitim Bakanlığı Talim ve Terbiye Kurulu Başkanlığı). *Fen ve Teknoloji dersi programı ilköğretim 4.–5. Sınıf*. Ankara, 2004

MEB (2006), (Millî Eğitim Bakanlığı Talim ve Terbiye Kurulu Başkanlığı). *Fen ve Teknoloji dersi programı ilköğretim 6.–8. Sınıf*. Ankara, 2006

Meisgeier, C, Murphy, £. & Swank, P. (1987). The development of the Murphy-Meisgeier Type Indicator for Children. *Journal of Psychological Type*, 13, 15-51.

Ministry of National Education [MNE] (2004a), Mufredat Gelistirme Sureci: Program gelistirme modeli çercevesinde yapılan çalismalar (Curricula Development Process: Activities Conducted around the Curricula Development Model). Ankara, Turkey: MNE

Moreno, N. (1999). K-12 science education reform-*A primer for scientists*. *BioScience*, 49(7), 569-577.

National Research Council (NRC). (1996). *National science education standards*. Washington, DC: U.S. Government Printing Office.

Nelson, G. (1999). Science literacy for all in the 21st century. *Educational Leadership*, 99(57), 2.

Olson, J., & Piatt, J. (2000). The instructional cycle: Teaching children and adolescents with special needs. *Upper Saddle River, NJ: Prentice-Hall*.

OSYM Official Web Site, Summary information on student selection examination. Retrieved November 3, 2006, from [http://www.osym.go v.tr](http://www.osym.go.v.tr).

Öğretmenler Portalı (2006). İlköğretim 5. sınıf Fen ve Teknoloji programı.

Retrieved October 27, 2006 from http://ttkb.meb.gov.tr/ogretmen/modules.php?name=Downloads&d_op=viewdownload &cid=74

Pekiner, G. (2007), Evaluation of the science and technology curricula at grade levels 4 and 5: A pilot study.

Piaget, J. (1969). The mechanisms of perception Rutledge & Kegan Paul, *London in TIP Theories*. Retrieved November 11, 2002 from <http://wwwpsychology.org7piaget.html>.

Rajecki, D. W. (1990). Attitudes. Sunderland, MA: Sinauer.

Richardson, V. (1999). Teacher education and the construction of meaning in Gary GrifBn (Ed.). *The education of teachers: Ninety-eight yearbook of the national society for the study of education*, part 1. ch. VI. University of Chicago Press. 46,145-166.

Reid, N. (2006). Thoughts on attitude measurement. *Research in Science & Technological Education*, 24(1), 3–27.

Rutherford, J., & Ahlgren, A. (1989). *Science for all Americans*. New York. Oxford University Press.

Shavelson, R. J. & Ruiz-Primo, M. A. (1998). On the assessment of science achievement conceptual underpinnings for the design of performance assessment: Report of year 2 activities. Center for the study of evaluation University of California, CA.

Semple, A. (2000). Learning theories and their influence on the development and use of educational technologies. *Australian Science Teachers Journal*, 46(3). Retrieved November 24, 2002, from <http://www.simulearn.net/pdf/Beneath%20the%20Tip.pdf>

Shepard, L.A. (2000). The role of assessment in a learning culture. *Educational Researcher*. 29 (7). 4-14.

Sirica, C. (1997). High marks for project 2061. *Science*, 275(5300), 685.

Snell, M. (1993). *Instruction of students with severe disabilities*. New York, NY: Macmillan.

Staver, J.R., (1986). The constructivist epistemology of Jean Piaget: Its philosophical roots and relevance to science teaching and learning. Paper presented at the United States-Japan Seminar on Science Education.

Sutman, F.X. (1993). Teaching Science Effectively to Limited English Proficient Students. ERIC/CUE Digest, Number 87. Pade 5 of 12.

Trautwein, U. & Köller, O. (2003). The relationship between homework and achievement-Still Much of a Mystery. *Educational Psychology Review*, 15(2), 115-145.

Talim Terbiye Kurulu Başkanlığı (2005). Yeni İlköğretim programları ve yaklaşımlar sunusu. Retrieved December 2006 from <http://www.ttkb.meb.gov.tr>.

Varis, F. (1996) Eğitimde Program Geliştirme: Teori ve Teknikler. (The Curricula Development in Education: Theory and Techniques) (6th edition). Ankara, Turkey: Alkim.

APPENDIX A

SCIENCE ACHIEVEMENT TEST (SAT)

7. SINIF FEN BİLGİSİ BAŞARI TESTİ

Sevgili öğrenciler, aşağıda verilen sorular sizlerin bir yıl boyunca fen bilgisi dersinde öğrendiklerinizi ölçmek için hazırlanmıştır. Lütfen soruları dikkatli okuyarak cevaplayınız ve boş soru bırakmamaya çalışınız. Bu testin sonuçları fen bilgisi dersi notunuzu etkilemeyecektir. Teşekkürler.

1. Atomların pek çoğunun çekirdeğinde,

- A) Sadece nötronlar vardır.
- B) Protonlar ve nötronlar vardır.
- C) Protonlar ve elektronlar vardır.
- D) Nötronlar ve elektronlar vardır.

2. Klor gazı sodyum metali ile reaksiyona girdiği zaman hangi tür bir madde meydana gelir?

- A) Karışım B) Bileşik C) Element D) Alaşım

3. Beyaz ve siyah renkli taneciklerden elde edilmiş tozun, aşağıdakilerden hangisi olması beklenir?

- A) Çözelti B) Karışım C) Saf bileşik D) Element

4. Ahmet 10 gram tuzu 100 ml su içerisinde çözerek bir çözelti elde ediyor.
Ahmet çözeltisinin çözünürlüğünü yarıya düşürmek için ilk çözeltiye ne eklemelidir?
A) 50 ml su B) 5 gram tuz C) 100 ml su D) 10 gram tuz

5. Oksijen, hidrojen ve su maddelerinden hangisi ya da hangileri elementtir?
A) Oksijen, hidrojen ve su B) Oksijen ve hidrojen
C) Sadece oksijen D) Sadece su

6. Bir sandalyenin atomlarının hepsini alırsanız geriye ne kalır?
A) Sandalye hala vardır fakat ağırlığı azalır.
B) Sandalye önceki haliyle tamamen aynı kalır.
C) Sandalyeden geriye hiçbir şey kalmaz.
D) Yerde sadece bir miktar sıvı birikintisi kalır.

7. Aşağıdakilerden hangisi karışım değildir?
A) Duman B) Şeker C) Süt D) Boya

8. Güneş aşağıdakilerden hangisine bir örnektir?
A) Kuyruklu yıldız C) Galaksi
B) Gezegen D) Yıldız

9. Aşağıdaki günlük aktivitelerden hangisi bir şehirdeki hava kirliliğinin doğrudan azalmasına yardımcı olabilir?
A) Televizyonun sesini azaltmak
B) Toprakta çözünebilir malzemeler kullanmak
C) Toplu ulaşım araçlarını kullanmak
D) Kağıtların geri dönüşümünü sağlamak

10.Şekildeki huni ve süzme kağıdı kullanılarak aşağıda verilen karışımlardan hangisi ayrıştırılabilir?

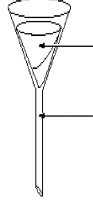

süzme kağıdı

huni

- A) Alkol-su karışımı
B) Oksijen-su karışımı
C) Su-pul biber karışımı
D) Tuz-pul biber karışımı

11. Bir göle yeni bir balık türü bırakıldığında aşağıda verilen değişimlerden hangisinin olması beklenemez?

- A) Diğer balıkların ihtiyacı olan bitkileri yiyebilirler.
B) Diğer balıkların ölümüne sebep olabilecek virüs taşıyabilirler.
C) Diğer balık türlerinin yaşam ortamlarına uyum sağlayamayabilirler.
D) Gölün suyunu kirletebilirler.

12. Jüpiter gezegeni Dünya'nın uydusundan daha büyüktür fakat Dünya'dan bakıldığında daha küçük gözükür. Bunun sebebi aşağıdakilerden hangisi ile açıklanabilir?

- A) Jüpiter, Güneş ışığını daha az yansıtır.
B) Ay, Dünya'nın etrafında döner.
C) Jüpiter, Dünya'ya Ay'dan daha uzaktır.
D) Bu bir çeşit göz yanılsamasıdır.

13.Dünya'nın ozon tabakasındaki deliğin aşağıda verilenlerden hangisine yol açması beklenemez?

- A) İnsanlar deri kanseri olabilir.
B) Göz hastalıkları artabilir.
C) Buz dağlarının erimesi hızlanabilir.
D) Güneş yanıkları görülme sıklığı artabilir.

14.Nötr bir atom elektron aldığı zaman aşağıdakilerden hangisi oluşur?

A) Karışım C) Molekül

B) İyon D)Metal

15.

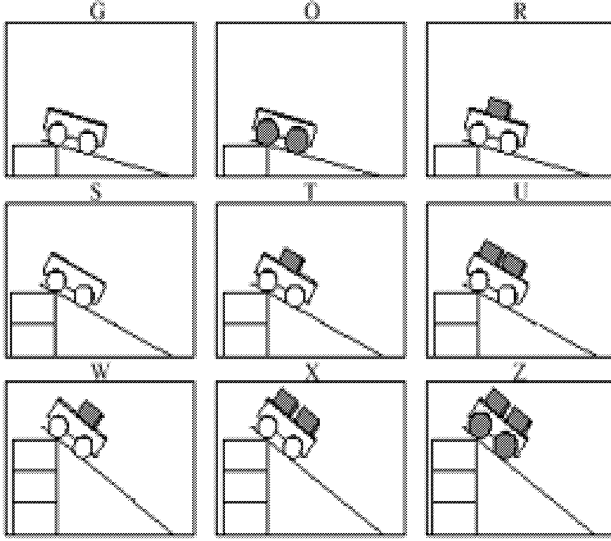

Yukarıdaki resimlerde Osman'ın el arabasıyla yaptığı dokuz farklı deneme gösterilmiştir. İki farklı tekerlek boyutuna sahip el arabası ile farklı sayılardaki eşit kütleye sahip cisimler taşınmış, her denemede aynı rampa farklı yüksekliklerde kullanılmıştır.

Osman şu fikri test etmek istiyor: 'Daha yüksek rampadan bırakılan el arabası daha hızlı ilerler'.Sizce Osman hangi üç denemeyi karşılaştırırsa bu fikrini ispatlayabilir?

A) G,O ve R B) R,U ve Z C) S,T ve X D) R, T ve W

16.Aşağıdaki tablo Merkür ve Venüs gezegenleri hakkında bazı bilgiler verilmiştir.

Gezegen	Ortalama yüzey sıcaklığı(C)	Atmosfer ortamı	Güneşe olan ortalama uzaklık(milyon km)	Güneş etrafında dönme süresi (gün)
Venüs	470	Çoğunlukla CO ₂	108	225
Merkür	300	Az miktarda atmosfer gazı	58	88

Aşağıdakilerden hangisi Venüs yüzey sıcaklığının Merkür'ün yüzey sıcaklığından daha fazla olmasının nedenini en iyi açıklar?

- A) Merkür'de daha az güneş ışığı soğurulur çünkü atmosfer gazları azdır.
- B) Venüs atmosferindeki karbondioksit yüzdesinin yüksek olması sera etkisine neden olmuştur.
- C) Venüs'ün Güneş etrafında dolanmasının uzun sürmesi Güneş'ten daha fazla ısı soğurmasını sağlar.
- D) Güneş ışınları Merkür'e tam dik değildir. Çünkü Güneş'e daha yakındır.

17.Aşağıdaki tabloda bir yaya farklı kütleler asıldığında yayın uzunluğunun nasıl değiştiğinin araştırıldığı bir deneyin sonuçları verilmiştir.

Bu tablo ile ilgili aşağıda verilenlerden hangisi doğrudur?

Kütle (gram)	Yayın uzunluğu (cm)
0	5
10	7
20	9
30	11
40	12
50	13
60	13

- A) Yaya asılan kütle miktarı arttıkça yayın uzunluğu artar.
B) Her bir kütle yayın uzunluğunu 2 cm artırır.
C) Kütle miktarının fazla olduğu durumlarda yayın uzama miktarı azalır
D) Yayın uzunluğu 40 gr ağırlığa kadar düzgün olarak uzamıştır.

18.

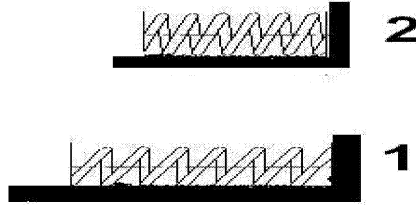

1.ve 2. yaylar başlangıçta aynı uzunlukta iken 1.yay biraz sıkıştırılıp resimdeki gibi sabitleniyor.2.yay ise daha fazla sıkıştırılarak sabitleniyor.

Hangi yayda daha fazla enerji depolanmıştır?

- A) 1.yay
B) 2.yay
C) İki yay da aynı enerjiye sahiptir.
D) Yayların yapıldığı madde bilinmeden bir şey söylenemez

19.

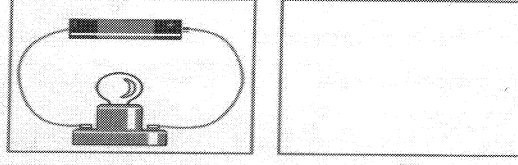

Laboratuvarda deney yapan bir öğrenci ampulün yanmama sebeplerinden birisinin bağlantıların pilin tek kutbuna yapılması olduğunu ispatlamak istiyor. Bu öğrenci yukarıda verilen düzeneğin yanına aşağıda verilen düzeneklerden hangisini kurarsa ispatını gerçekleştirmiş olur?

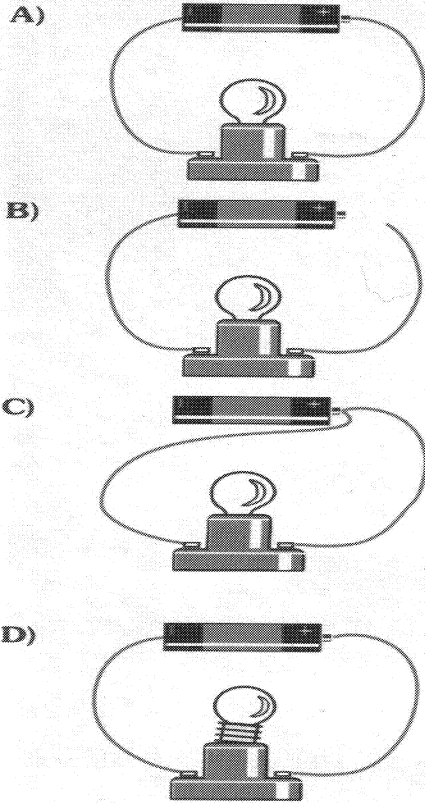

20.

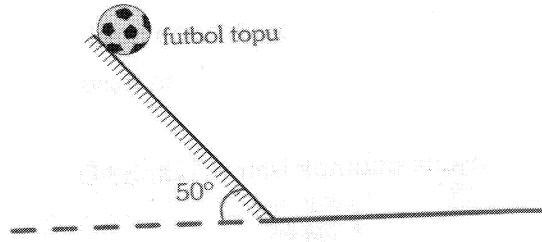

Şekilde eğik düzlem üzerinden bırakılan topun halının üzerinde kaç saniye sonra durduğu ölçülüyor.

Sürtünme kuvvetinin yüzeyin cinsine bağlı olduğunu bulmak isteyen bir öğrenci aşağıda verilen hangi ikinci düzeneği kurarsa amacına ulaşabilir?

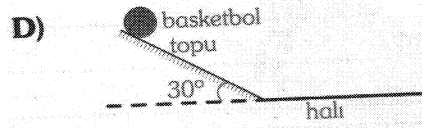
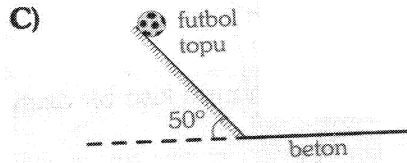
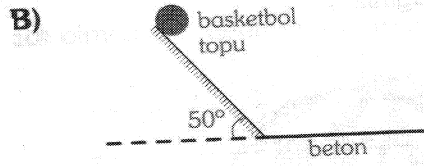
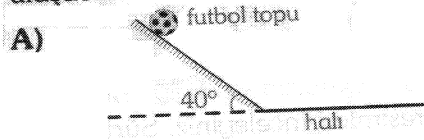

21. Güneş, Dünya ve Ay'ın büyüklüklerini karşılaştıran bir öğrenci basketbol topu, leblebi tanesi ve bulgur tanesi kullanıyor. Sizce bu malzemeler hangi gök cisimlerinin büyüklükleri ile orantılı olabilir?

	<u>Basketbol Topu</u>	<u>Bulgur Tanesi</u>	<u>Leblebi Tanesi</u>
A)	Dünya	Güneş	Ay
B)	Ay	Dünya	Güneş
C)	Güneş	Ay	Dünya
D)	Güneş	Dünya	Ay

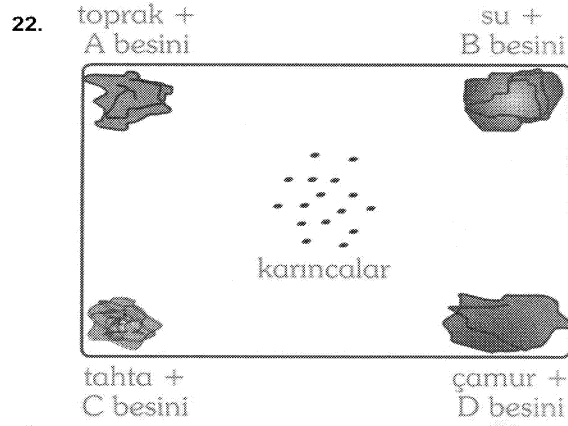

Şekilde verilen düzeneği kuran bir öğrenci bu düzeneği kurmakla aşağıda verilenlerden hangisine ulaşmak istemektedir?

- A) Karıncaların hangi besinleri sevdiğine
- B) Karıncaların yaşam şartlarının ne olduğuna
- C) Karıncaların beslenme ve yaşam şartlarının ne olduğuna
- D) Karıncaların yön kavramlarının ne olduğuna

23.

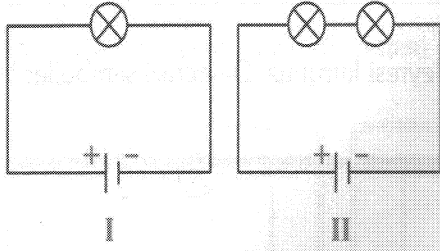

Şekilde verilen iki düzeneği kuran bir öğrenci ampulün parlaklığının hangi değişkene bağlı olduğunu bulmak istemektedir?

- A) pil sayısına B) ampul sayısına
C) kablonun cinsine D) ampulün cinsine

24. Ampulün parlaklığının pil sayısına nasıl bağlı olduğunu bulmak isteyen bir öğrenci aşağıda verilen devrelerden hangi ikisini kurarsa amacına ulaşabilir?

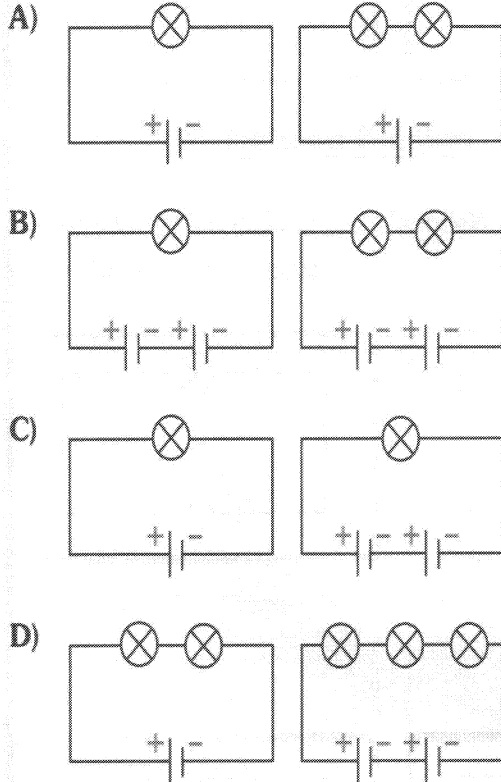

25.

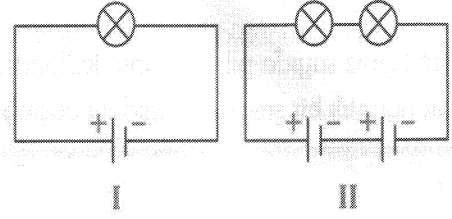

Bir öğrenci ampul sayısı azaldıkça ampulün parlaklığının artacağını bulmak istiyor. Bunun için yukarıda verilen iki devreyi kurmuştur. Sizce öğrenci amacına ulaşabilmek için kurduğu devrelerde hangi değişiklikleri yapmalıdır?

- A) II. devreden bir ampul çıkarmalıdır.
B) II. devreden bir pil çıkarmalıdır.
C) I. devreye bir ampul eklemelidir.
D) I. devreye iki pil eklemelidir.

26.

Pil sayısının sabit tutularak ampul sayısının değiştirildiği ve bunun sonucu olarak da ampulün parlaklığının incelendiği bir deney yapılıyor. Bu deneydeki değişkenler aşağıdakilerden hangisinde doğru verilmiştir?

	Bağımsız Değişken	Kontrol Edilen Değişken	Bağımlı Değişken
A)	pil sayısı	ampul sayısı	ampul parlaklığı
B)	ampul Sayısı	pil sayısı	ampul parlaklığı
C)	ampul Sayısı	ampul sayısı	ampul parlaklığı
D)	pil Sayısı	pil sayısı	ampul parlaklığı

APPENDIX B

TABLE OF SPECIFICATION OF SCIENCE ACHIEVEMENT TEST

Contents/Objective Level	KUL	HOTS
Structure Of Matter	1,2,3,4,5,6,7,14	10
The Space Puzzle	8,12,21	16
Human and Environment	9,13	11,22
Force and Motion	18	15,17,20
Electricity In Our Lives	26	19,23,24,25

KUL (Knowledge and Understanding Level) covers Knowledge, Comprehension, Application Levels.

HOTS (Higher Order Thinking Skills Level) covers Analysis, Synthesis, Evaluation Levels.

APPENDIX C

THE OBJECTIVES OF SCIENCE ACHIEVEMENT TEST QUESTIONS

7. Sınıf Fen Bilgisi Başarı Testi Soruları Kazanımları

1.SORU

ÖĞRENME ALANI: MADDE VE DEĞİŞİM

ÜNİTE 4 : Maddenin Yapısı ve Özellikleri

KAZANIM 1 : 2.3. *Atomun çekirdeğinde bulunan temel parçacıkları bilir.*

2.SORU

ÖĞRENME ALANI: MADDE VE DEĞİŞİM

ÜNİTE 4 : Maddenin Yapısı ve Özellikleri

KAZANIM 1 : 5.2. *Farklı atomların bir araya gelmesiyle oluşan maddeleri bileşik olarak adlandırır.*

KAZANIM 2 : 5.3. *Her bileşikte en az iki element bulunduğunu fark eder.*

3.SORU

ÖĞRENME ALANI: MADDE VE DEĞİŞİM

ÜNİTE 4 : Maddenin Yapısı ve Özellikleri

KAZANIM 1 : 6.1. *Karışımlarda birden çok element veya bileşik bulunduğunu fark eder.*

“Bilimsel Süreç Beceri” Kazanımları (BSB)

KARŞILAŞTIRMA-SINIFLAMA

Nesneleri sınıflandırmada kullanılacak nitel ve nicel özellikleri belirler.

4.SORU

ÖĞRENME ALANI: MADDE VE DEĞİŞİM

ÜNİTE 4 : Maddenin Yapısı ve Özellikleri

KAZANIM 1 : 6.8.Çözeltilerin nasıl seyreltileceğini ve/veya değiştirileceğini bilir.

“Bilimsel Süreç Beceri” Kazanımları (BSB)

HİPOTEZ KURMA

Verilen bir olaydaki bağımsız değişkenin bağımlı değişken üzerindeki etkisini denenebilir bir önerme şeklinde ifade eder.

5.SORU

ÖĞRENME ALANI: MADDE VE DEĞİŞİM

ÜNİTE 4 : Maddenin Yapısı ve Özellikleri

KAZANIM 1 : 1.2. Farklı elementlerin atomlarının farklı olduğunu sezer

KAZANIM 2 : 1.3. Periyodik sistemdeki ilk 20 elementi ve günlük hayatta karşılaştığı yaygın element isimlerini listeler

“Bilimsel Süreç Beceri” Kazanımları (BSB)

KARŞILAŞTIRMA-SINIFLAMA

Nesneler veya olaylar arasındaki belirgin benzerlikleri ve farklılıkları saptar.

Gözlemlere dayanarak bir veya birden fazla özelliğe göre karşılaştırmalar yapar.

GÖZLEM

Bir cismin şekil, renk, büyüklük ve yüzey özellikleri gibi duyuşsal özelliklerini belirler.

KARŞILAŞTIRMA-SINIFLAMA

Nesneleri sınıflandırmada kullanılacak nitel ve nicel özellikleri belirler.

Nesneler veya olaylar arasındaki belirgin benzerlikleri ve farklılıkları saptar.

6.SORU

ÖĞRENME ALANI: MADDE VE DEĞİŞİM

ÜNİTE 4 : Maddenin Yapısı ve Özellikleri

KAZANIM 1 : 2.1. *Maddeyi oluşturan atomları, bağlı atomları ve molekülleri maddenin fiziksel özellikleri ile ilişkilendirir.*

“Bilimsel Süreç Beceri” Kazanımları (BSB)

ÇIKARIM YAPMA

Olmuş olayların sebepleri hakkında gözlemlere dayanarak açıklamalar yapar.

YORUMLAMA VE SONUÇ ÇIKARMA

İşlenen verileri ve oluşturulan modeli yorumlar.

“Tutum ve Değer” Kazanımları (TD)

ALGILAMA (Dikkatini vermesi ve sabit tutması)

- Açık fikirlidir.
- Ön yargıları yoktur.

7.SORU

ÖĞRENME ALANI: MADDE VE DEĞİŞİM

ÜNİTE 4 : Maddenin Yapısı ve Özellikleri

KAZANIM 1 : 6.1. *Karışımlarda birden çok element veya bileşik bulunduğunu fark eder*

Bilimsel Süreç Beceri” Kazanımları (BSB)

GÖZLEM

Bir cismin şekil, renk, büyüklük ve yüzey özellikleri gibi duyuşsal özelliklerini belirler.

KARŞILAŞTIRMA-SINIFLAMA

Nesneleri sınıflandırmada kullanılacak nitel ve nicel özellikleri belirler.

8.SORU

ÖĞRENME ALANI: DÜNYA VE EVREN

ÜNİTE 7 : Güneş Sistemi ve Ötesi: Uzay Bilmecesi

KAZANIM 1 : *1.6. Güneş'in de bir yıldız olduğunu ifade eder*

“Bilimsel Süreç Beceri” Kazanımları (BSB)

GÖZLEM

Bir cismin şekil, renk, büyüklük ve yüzey özellikleri gibi duyuşal özelliklerini belirler.

9.SORU

ÖĞRENME ALANI: CANLILAR VE HAYAT

ÜNİTE 6 : İnsan ve Çevre

KAZANIM 1 : *1.9. Ülkemizdeki ve dünyadaki çevre sorunlarından bir tanesi hakkında çözüm üretir.*

“Fen-Teknoloji-Toplum-Çevre” Kazanımları (FTTÇ)

İnsanların ve toplumun çevreyi nasıl etkilediğini bilir.

Çevre koruma il ilgili faaliyetlerin öneminin bilincine varır ve bu faaliyetlere katılır.

10.SORU

ÖĞRENME ALANI: MADDE VE DEĞİŞİM

ÜNİTE 4 : Maddenin Yapısı ve Özellikleri

KAZANIM 1 : *6.1. Karışımlarda bulunan birden çok element veya bileşiğin nasıl ayrıştırılacağını bili.*

11.SORU

ÖĞRENME ALANI: CANLILAR VE HAYAT

ÜNİTE 6 : İnsan ve Çevre

KAZANIM 1 : *1.2. Bir ekosistemdeki canlı organizmaların birbirleriyle ve cansız faktörlerle ilişkilerini açıklar.*

KAZANIM 2 :1.3. *Farklı ekosistemlerde bulunabilecek canlılar hakkında tahminler yapar*

12.SORU

ÖĞRENME ALANI: DÜNYA VE EVREN

ÜNİTE 7 : Güneş Sistemi ve Ötesi: Uzay Bilmecesi

KAZANIM 1 : 2.1. *Güneş sistemindeki gezegenleri Güneş'e yakınlıklarına göre sıralar*

“Bilimsel Süreç Beceri” Kazanımları (BSB)

KARŞILAŞTIRMA-SINIFLAMA

Nesneleri sınıflandırmada kullanılacak nitel ve nicel özellikleri belirler.

13.SORU

ÖĞRENME ALANI: CANLILAR VE HAYAT

ÜNİTE 6 : İnsan ve Çevre

KAZANIM 1 : 1.10. *Dünyadaki bir çevre probleminin ne tür sonuçlar doğurabileceğine ilişkin çıkarımlarda bulunur*

“Bilimsel Süreç Beceri” Kazanımları (BSB)

ÇIKARIM YAPMA

Olmuş olayların sebepleri hakkında gözlemlere dayanarak açıklamalar yapar.

“Fen-Teknoloji-Toplum-Çevre” Kazanımları (FTTÇ)

Atıkların (evsel, sanayi, tıbbî, kurumsal vb.) çevreye verebileceği zararları önlemek için uygun bir şekilde geri dönüştürülmesi veya imha edilmesi gerektiğini; teknolojik sistemlerin oluşturduğu atıkların (kimyasallar, plâstikler, metaller vb.) yönetiminin önemli bir toplumsal sorun olduğunu anlar.

14.SORU

ÖĞRENME ALANI: MADDE VE DEĞİŞİM

ÜNİTE 4 : Maddenin Yapısı ve Özellikleri

KAZANIM 1 : 3.4. *Atomların elektron verdiği pozitif (+), elektron aldığı ise negatif (-) yük ile yüklendiği çıkarımını yapar.*

KAZANIM 2 : 3.5. *Yüklü atomları “iyon” olarak adlandırır*

15.SORU

ÖĞRENME ALANI: FİZİKSEL OLAYLAR

ÜNİTE 2 : Kuvvet ve Hareket

KAZANIM 1 : 2.7. *Cisimlerin konumları nedeniyle çekim potansiyel enerjisine sahip olduğunu belirtir.*

KAZANIM 2 : 2.8. *Çekim potansiyel enerjisinin cismin ağırlığına ve yüksekliğine bağlı olduğunu keşfeder*

“Bilimsel Süreç Beceri” Kazanımları (BSB)

DEĞİŞKENLERİ KONTROL ETME VE DEĞİŞTİRME

Hipotezle ilgili olan değişkenlerin dışındaki değişkenleri sabit tutar.

Bağımsız değişkeni değiştirerek bağımlı değişken üzerindeki etkisini belirler.

16.SORU

ÖĞRENME ALANI: DÜNYA VE EVREN

ÜNİTE 7 : Güneş Sistemi ve Ötesi: Uzay Bilmecesi

KAZANIM 1 : 2.4. *Güneş sistemindeki gezegenleri, belirgin özelliklerine (birbirlerine göre büyüklükleri, doğal uydu sayıları, etraflarında halka olup olmaması) göre karşılaştırır*

17.SORU

ÖĞRENME ALANI: FİZİKSEL OLAYLAR

ÜNİTE 2 : Kuvvet ve Hareket

KAZANIM 1 : *1.1. Yayların esneklik özelliği gösterdiğini gözlemler*

KAZANIM 2 : *1.3. Bir yayı geren veya sıkıştıran kuvvetin artması durumunda yayın uyguladığı kuvvetin de arttığını fark eder*

KAZANIM 3 : *1.4. Bir yayın esneklik özelliğini kaybedebileceğini keşfeder.*

18.SORU

ÖĞRENME ALANI: FİZİKSEL OLAYLAR

ÜNİTE 2 : Kuvvet ve Hareket

KAZANIM 1 : *2.10. Sıkıştırılmış veya gerilmiş bir yayın esneklik potansiyel enerjisine sahip olduğunu fark eder*

KAZANIM 2 : *2.11. Yayın esneklik potansiyel enerjisinin yayın sıkışma (veya ,gerilme) miktarına bağlı olduğunu keşfeder*

19.SORU

ÖĞRENME ALANI:FİZİKSEL OLAYLAR

ÜNİTE 3 : Yaşamımızdaki Elektrik

KAZANIM 1 : *2.3. Elektrik devrelerinde akımın oluşması için kapalı bir devre olması gerektiğini fark eder.*

20.SORU

ÖĞRENME ALANI: FİZİKSEL OLAYLAR

ÜNİTE 2 : Kuvvet ve Hareket

KAZANIM 1 : *4.2. Sürtünme kuvvetinin, kinetik enerjide bir azalmaya sebep olacağını fark eder*

KAZANIM 2 : *4.3. Kinetik enerjideki azalmayı enerji dönüşümüyle açıklar.*

“Bilimsel Süreç Beceri” Kazanımları (BSB)

DENEY DÜZENEĞİ KURMA

Verilen malzemeleri kullanarak kurduğu hipotezi sınınamaya yönelik tasarladığı deneği gerçekleştireceği bir düzenek kurar.

DEĞİŞKENLERİ KONTROL ETME VE DEĞİŞTİRME

Hipotezle ilgili olan değişkenlerin dışındaki değişkenleri sabit tutar.

Bağımsız değişkeni değiştirerek bağımlı değişken üzerindeki etkisini belirler.

21.SORU

ÖĞRENME ALANI: DÜNYA VE EVREN

ÜNİTE 7 : Güneş Sistemi ve Ötesi: Uzay Bilmecesi

KAZANIM 1 : 2.4. *Güneş sistemindeki gezegenleri, belirgin özelliklerine (birbirlerine göre büyüklükleri, doğal uydu sayıları, etraflarında halka olup olmaması) göre karşılaştırır*

“Bilimsel Süreç Beceri” Kazanımları (BSB)

KARŞILAŞTIRMA-SINIFLAMA

Nesneleri sınıflandırmada kullanılacak nitel ve nicel özellikleri belirler.

Nesneler veya olaylar arasındaki belirgin benzerlikleri ve farklılıkları saptar

22.SORU

ÖĞRENME ALANI: CANLILAR VE HAYAT

ÜNİTE 6 : İnsan ve Çevre

KAZANIM 1 : 1.2. *Bir ekosistemdeki canlı organizmaların birbirleriyle ve cansız faktörlerle ilişkilerini açıklar.*

23.SORU

ÖĞRENME ALANI:FİZİKSEL OLAYLAR

ÜNİTE 3 : Yaşamımızdaki Elektrik

KAZANIM 1 : 3.2. *Ampullerin seri bağlanması durumunda ampullerin parlaklığının bağlı olduğu değişkenleri keşfeder.*

“Bilimsel Süreç Beceri” Kazanımları (BSB)

TAHMİN

Gözlem, çıkarım veya deneylere dayanarak geleceğe yönelik olası sonuçlar hakkında fikir öne sürer.

24.SORU

ÖĞRENME ALANI: FİZİKSEL OLAYLAR

ÜNİTE 3 : Yaşamımızdaki Elektrik

KAZANIM 1 : 2.9. *Bir devre elemanının uçları arasındaki gerilim ile üzerinden geçen akım arasındaki ilişkiyi deneyerek keşfeder*

“Bilimsel Süreç Beceri” Kazanımları (BSB)

TAHMİN

Gözlem, çıkarım veya deneylere dayanarak geleceğe yönelik olası sonuçlar hakkında fikir öne sürer.

YORUMLAMA VE SONUÇ ÇIKARMA

İşlenen verileri ve oluşturulan modeli yorumlar.

Elde edilen bulgulardan desen ve ilişkilere ulaşır

25.SORU

ÖĞRENME ALANI: FİZİKSEL OLAYLAR

ÜNİTE 3 : Yaşamımızdaki Elektrik

KAZANIM 1 : *Devredeki ampul sayısı ile ampul parlaklığı arasındaki ilişkiyi açıklar.*

“Bilimsel Süreç Beceri” Kazanımları (BSB)

ÇIKARIM YAPMA

Olmuş olayların sebepleri hakkında gözlemlere dayanarak açıklamalar yapar.

TAHMİN

Gözlem, çıkarım veya deneylere dayanarak geleceğe yönelik olası sonuçlar hakkında fikir öne sürer.

YORUMLAMA VE SONUÇ ÇIKARMA

İşlenen verileri ve oluşturulan modeli yorumlar.

Elde edilen bulgulardan desen ve ilişkilere ulaşır

26.SORU

ÖĞRENME ALANI: FİZİKSEL OLAYLAR

ÜNİTE 3 : Yaşamımızdaki Elektrik

KAZANIM 1 : 3.2. *Pil ve ampul sayılarının ampul parlaklığı ile olan ilişkiyi açıklar.*

“Bilimsel Süreç Beceri” Kazanımları (BSB)

DEĞİŞKENLERİ KONTROL ETME VE DEĞİŞTİRME

Hipotezle ilgili olan değişkenlerin dışındaki değişkenleri sabit tutar.

Bağımsız değişkeni değiştirerek bağımlı değişken üzerindeki etkisini belirler.

APPENDIX D

FEN VE TEKNOLOJİ DERSİ TUTUM ÖLÇEĞİ

Sevgili öğrenciler, aşağıda yer alan ölçek sizin Fen ve Teknoloji dersine olan tutumunuzu belirlemek amacıyla hazırlanmıştır. Ölçekte Fen ve Teknoloji dersine karşı tutum cümleleri ile her cümlenin karşısında **Tamamen Katılıyorum**, **Katılıyorum**, **Kararsızım**, **Katılmıyorum**, **Hiç Katılmıyorum** seçenekleri yer almaktadır. Her cümleyi dikkatlice okuduktan sonra kendinize en uygun seçeneği işaretleyiniz.

	Tamamen Katılıyorum	Katılıyorum	Kararsızım	Katılmıyorum	Hiç Katılmıyorum
1.Okulu bitirdiğimde bilim adamı olmak isterim.					
2.Mezun olunca fen ile ilgili bir laboratuarda çalışmayı istemem.					
3.Bilim adamı olarak çalışmak sıkıcı olabilir.					
4.Bilim adamı olarak çalışmak ilginç olabilir.					
5.Fenle ilgili bir işi severek yapabilirim.					
6.Evde fen ile ilgili programları izlerken		110			

sıkılıyorum.					
7.Radyoda fen ile ilgili konuda bir konuşma dinlemek sıkıcı gelir.					
8.Okuldan çıktıktan sonra arkadaşlarla bilimsel konulardan söz etmek sıkıcıdır.					
9.Hafta sonu bir fen müzesini severek gezebilirim.					
10.Fen ile ilgili bilimsel gazete makaleleri okumak bana sıkıcı gelir.					
11.Bilimsel fen projelerine harcanan para boşa harcanmıştır.					
12.Devlet bilimsel araştırmalara daha fazla para yatırmalıdır.					
13.Fen bilimi gelecekte dünyayı daha yaşanabilir bir yer haline getirmede etkili olacaktır.					
14.Fen bilimi hayatı iyileştirir.					
15.Fen bilimine harcanmış para, iyiye harcanmış paradır.					
16.Fen dersleri beni sıkar.					
17.Fen okuldaki derslerin en ilginçidir.					
18.Fen dersleri eğlencelidir.					
19.Fen derslerine girmekten zevk alıyorum.					
20.Okulda haftaya başına düşen fen		111			

dersi sayısı daha fazla olmalıdır.					
21.Bilim adamları ailelerine yeterince vakit ayıramazlar.					
22.Bilim adamları diğer insanlar kadar spordan hoşlanırlar.					
23.Bilim adamları diğer insanlardan daha az arkadaş canlısıdır.					
24.Bilim adamları normal bir aile yaşantısına sahip değildir.					
25.Çok az bilim adamının mutlu bir evliliği vardır.					

APPENDIX F

TEACHERS' CLASSROOM ACTIVITIES SCALE

FEN VE TEKNOLOJİ DERSİ ÖĞRENCİ ANKETİ

Sevgili öğrenciler,

Aşağıda yer alan ölçek sizinle ilgili bazı kişisel bilgileri ve Fen ve Teknoloji dersinin nasıl yapıldığına dair görüşlerinizi almak için hazırlanmıştır. Ölçekteki her cümlenin karşısında **Hemen her gün, Haftada 1-2 kez, Ayda 1-2 kez, Dönem boyunca 1-2 kez, Hiçbir zaman** seçenekleri yer almaktadır. Her cümleyi dikkatlice okuduktan sonra kendinize en uygun seçeneği işaretleyiniz.

Cinsiyet:.....

Annenizin en son mezun olduğu okul türü:.....

Babanızın en son mezun olduğu okul türü:.....

Okula devam etmediğim gün sayısı:.....

Haftada ortalama kaç saat fen bilgisi çalışırsınız?

Evinizde yaklaşık olarak kaç kitap bulunur?.....

Evinizde sizinle beraber kaç kişi yaşamaktadır?.....

Aşağıda verilen ev eşyalarından hangileri sizde var ise o eşyaların numaralarını yuvarlak içine alınız.

- | | |
|------------------------------|---------------------|
| 1. Hesap makinesi | 6. Sözlük |
| 2. Bilgisayar | 7. Ansiklopedi |
| 3. Bulaşık makinesi | 8. Deney setleri |
| 4. Kendime ait odam | 9. Çamaşır makinesi |
| 5. Kendime ait çalışma masam | |

	Hemen her gün	Haftada 1-2 kez	Ayda 1-2 kez	Dönem boyunca 1-2 kez	Hiçbir zaman
1.Öğretmenim fen bilgisi dersinde benimle ilgilenir.					
2.Öğretmenim benim fen bilgisini nasıl öğrendiğimi bilir.					
3.Öğretmenim fen bilgisi dersinde yaptıklarımın ve söylediklerimin doğruluğu konusunda bana yol gösterir.					
4.Öğretmenim fen bilgisi dersinde ders araç ve gereçlerinden yararlanır.					
5.Öğretmenim fen bilgisinde anlamadığım konuları tekrar açıklar.					
6.Öğretmenim beni dinler ve bana değer verir.					
7.Öğretmenim fen bilgisi dersinde bilgileri anlayacağım bir sıra içinde sunar.					
8.Fen bilgisini eğlenerek öğrenirim.					
9.Öğretmenim fen bilgisi dersinde derse katılmama sağlar.					
10.Öğretmenim fen bilgisi dersi ile ilgili araştırma yapmama yardımcı olur.					
11.Fen bilgisi dersinde öğretmen yaptıklarını ve anlattıklarını sessizce takip ederiz.					
12.Fen bilgisi dersinde çalışma kağıtları dağıtılır.					
13.Öğretmenim fen bilgisi konularını bizimle birlikte tartışır.					
14.Öğretmenim fen bilgisi ile ilgili soru ve problemlerin çözümünde bana yardımcı olur.					
15.Öğretmenim fen bilgisi derslerinde VCD, tepegöz, bilgisayar gibi araçları kullanır.					
16.Öğretmenim fen bilgisi anlatırken VCD, tepegöz, bilgisayar gibi araçları kullandığında daha iyi öğreniyorum.					
	114				

17.Öğretmenim fen bilgisi derslerinde boya kalemleri, resimler, renkli kartonlar kullanmamıza izin verir.					
18.Fen bilgisi dersinde boya kalemleri, resimler, renkli kartonlar kullanıldığında daha çok eğleniyorum.					
19.Fen bilgisi dersinde arkadaşlarımızla grup çalışması yaparız.					
20.Fen bilgisinde grup çalışması yaptığımızda konuyu daha iyi anlıyorum.					
21.Öğretmenim fen bilgisi dersinde proje çalışmaları verir.					
22.Hazırladığımız fen projelerini sınıfta sunarız.					
23.Fen bilgisinde, proje çalışmalarını kağıda yazıp öğretmenimize veririz.					
24.Fen bilgisinde proje ödevlerini yapmakta zorlanıyorum.					
25.Fen bilgisinde proje ödevlerini yaparken konuyu daha iyi anlıyorum					
26.Öğretmenim projelerimizi bitene kadar projelerimizle ilgilenir.					
27.Proje çalışmamız bittiğinde öğretmenim eksiklerimizi anlatır.					
28.Fen bilgisi dersinde ürün seçki dosyası hazırlarız.					
29.Fen bilgisinde ürün seçki dosyası hazırlarken zorlanırım.					
30.Fen bilgisinde ürün seçki dosyası hazırlarken konuyu daha iyi öğreniyorum.					
31.Fen dersini deneyler yaparak öğreniriz.					
32.Fen dersinde deneyleri öğretmenimiz yapar, biz seyrederek.					
33.Fen bilgisi dersinde deneyleri gruplar halinde yaparız.					
34.Fen dersinde deney yaptığımızda konuyu daha iyi anlıyorum.					
35.Fen bilgisinde çeşitli oyunlar oynarız.					
	115				

36.Fen bilgisi derslerini oyunlarla işlediğimizde hangi konuyu işlediğimizi karıştırıyorum.					
37.Fen bilgisi derslerinde oynadığımız oyunlar, işlediğimiz konuya uygun olur.					
38.Öğretmenim fen bilgisi dersini tahtada anlatır.					
39.Öğretmenim fen bilgisi dersini tahtada anlattığında konuyu daha iyi anlıyorum.					
40.Öğretmenim günlük olaylardan örnekler verir					
41.Öğretmenim fen bilgisi dersini benim eğlendiğim ve anladığım biçimde işler.					
42.Öğretmenim fen araştırmamız için bilgisayar kullanmamızı destekler.					
43.Öğretmenim fen bilgisinde yeni konuya başlarken o konu ile ilgili sorular sorar.					
44.Öğretmenim fen bilgisiyle ilgili soru sorduktan sonra düşünmemiz için yeterli zaman verir.					
45.Öğretmenim bizi sözlü yapar.					