

HYDRAULIC CHARACTERISTICS OF TYROLEAN WEIRS

A THESIS SUBMITTED TO  
THE GRADUATE SCHOOL OF NATURAL AND APPLIED SCIENCES  
OF  
MIDDLE EAST TECHNICAL UNIVERSITY

BY

NAZLI ASLICAN YILMAZ

IN PARTIAL FULFILLMENT OF THE REQUIREMENTS  
FOR  
THE DEGREE OF MASTER OF SCIENCE  
IN  
CIVIL ENGINEERING

DECEMBER 2010

Approval of the thesis:

**HYDRAULIC CHARACTERISTICS OF TYROLEAN WEIRS**

submitted by **NAZLI ASLICAN YILMAZ** in partial fulfillment of the requirements for the degree of **Master of Science in Civil Engineering Department, Middle East Technical University** by,

Prof. Dr. Canan Özgen  
Dean, Graduate School of **Natural and Applied Sciences**

\_\_\_\_\_

Prof. Dr. Güney Özcebe  
Head of Department, **Civil Engineering Dept.,**

\_\_\_\_\_

Prof. Dr. Mustafa Gögüş  
Supervisor, **Civil Engineering Dept., METU**

\_\_\_\_\_

**Examining Committee Members:**

Assoc. Prof. Dr. İsmail Aydın  
Civil Engineering Dept., METU

\_\_\_\_\_

Prof. Dr. Mustafa Gögüş  
Civil Engineering Dept., METU

\_\_\_\_\_

Assoc. Prof. Dr. Ayşe Burcu Altan Sakarya  
Civil Engineering Dept., METU

\_\_\_\_\_

Asst. Prof. Dr. Mete Köken  
Civil Engineering Dept., METU

\_\_\_\_\_

Assoc. Prof. Dr. Mehmet Ali Kökpınar  
TAKK Dept., DSI

\_\_\_\_\_

**Date:** 20/12/2010

**I hereby declare that all information in this document has been obtained and presented in accordance with academic rules and ethical conduct. I also declare that, as required by these rules and ethical conduct, I have fully cited and referenced all material and results that are not original to this work.**

Name, Last name: Nazlı Aslıcan Yılmaz

Signature:

## **ABSTRACT**

### HYDRAULIC CHARACTERISTICS OF TYROLEAN WEIRS

Yılmaz, Nazlı Aslıcan

M.Sc., Department of Civil Engineering

Supervisor: Prof. Dr. Mustafa Göğüş

December 2010, 113 pages

Tyrolean type water-intake structures are widely used on mountain rivers to provide water to hydropower stations. The main concern encountered in these kinds of structures is the amount of water diverted from the main channel and sediment carried by this flow. The diverted flow should not be less than the design discharge of the hydropower station and the amount of the sediment entering the hydraulic system should be minimum. In this study a physical model of a Tyrolean weir was constructed at the Hydromechanics Laboratory and by varying the dimensions of the various components of this system; the length, the inclination angle of the rack and the distance between the rack bars, the amount of water and sediment entering the system were measured for a wide range of discharges. The experiments were conducted in two stages. In the first stage the tests were made with only water, and in the second stage, water and sediment having different gradation were used.

Applying dimensional analysis to the related parameters of the system dimensionless terms were defined for water capture efficiency and discharge coefficient of the system, and their variations with the relevant parameters were plotted. Using these diagrams one can determine the amount of water to be diverted by a Tyrolean weir of known geometry and main channel flow.

Keywords: Tyrolean weirs, hydraulics, open channel flow, water capture efficiency, sediment, intake racks.

## ÖZ

### TİROL TİPİ SAVAKLARIN HİDROLİK KARAKTERİSTİKLERİ

Yılmaz, Nazlı Aslıcan

Yüksek Lisans, İnşaat Mühendisliği Bölümü

Tez Yöneticisi: Prof. Dr. Mustafa Göğüş

Aralık 2010, 113 sayfa

Tirol tipi su alma yapıları hidroelektrik santrallerine su iletmek için dağlık bölgelerdeki akarsularda sıkça kullanılır. Bu tip yapılar ile ilgili en önemli konu hidrolik sisteme girecek olan su ve katı madde miktarıdır. Sisteme alınan su miktarının tasarım debisinden daha küçük olmaması, katı madde miktarının da minimumda tutulması gerekir. Bu çalışmada, Tirol tipi bir savağın fiziksel modeli Hidromekanik Laboratuvarı'nda inşa edildi ve çeşitli bileşenlerinin boyutları değiştirilerek; ıslak ızgara uzunluğu, ızgara eğiminin açısı ve ızgara parmaklıklarının arasındaki açıklık; sisteme giren su ve su ile beraber giren katı madde miktarı pek çok farklı debi için ölçüldü. Deneyler iki aşamada yapıldı. İlk aşamada deneyler sadece su ile ikinci aşamada ise su ve katı madde ile yapıldı.

Sistemin değişkenlerine boyut analizi uygulanarak debi katsayısı ve sistemin ana kanaldan su alabilme yeterliliği için boyutsuz terimler tanımlandı ve bunların ilgili parametrelerle değişimleri çizildi. Elde edilen

bu grafikler kullanarak, kořulları belirli bir akarsudan geometrisi belli bir Tirol tipi savakla alınabilecek su miktarı hesaplanabilir.

Anahtar kelimeler: tirol tipi savaklar, hidrolik, açık kanal akımı, su tutma verimliliđi, katı madde, su alma ızgaraları

To my father



## **ACKNOWLEDGMENTS**

First of all, I would like to express my sincere gratitude to Prof. Dr. Mustafa Gögüş, for his support, patience, encouragement and confidence on me from the very first day.

I would like to thank to the laboratory technicians for making thoughts come true with their hard study.

Then, my heartiest thanks go to Tuğçe Yıldırım, for showing me every kind of help and support at every turn and making my day everyday.

I want to thank to Ezgi Köker, Beliz Uğurhan, Onur Dündar and Meriç Apaydın for being best co-workers a person can ever has.

My deepest gratitude goes to my parents for their endless support during this study as in the entire of my lifetime.

## TABLE OF CONTENTS

ABSTRACT.....	iv
ÖZ .....	vi
ACKNOWLEDGMENTS.....	ix
TABLE OF CONTENTS .....	x
LIST OF TABLES.....	xiii
LIST OF FIGURES.....	xix
LIST OF SYMBOLS.....	xxiii
CHAPTERS	
1. INTRODUCTION.....	1
1.1. General.....	1
1.1. Literature Review .....	4
2. THEORETICAL STUDY .....	11
2.1. Introduction.....	11
2.2. Derivation of the Discharge Coefficient For Tyrolean Weirs .....	11
2.3. Water Capture Efficiency and Wetted Rack Length of Tyrolean Weirs.....	13
3. EXPERIMENTAL SETUP AND PROCEDURE .....	15
3.1. Experimental Setup .....	15
3.2. Experimental Procedure.....	23

3.2.1 Discharge Measurements .....	23
3.2.2 Measurement of the Wetted Rack Lengths .....	26
3.2.3 Determination of the Water Capture Efficiencies.....	26
3.2.4 Experiments Conducted with Sediment .....	27
3.2.4 Uncertainty Analysis .....	27
4. ANALYSIS OF THE EXPERIMENTAL DATA AND DISCUSSION OF THE RESULTS.....	30
4.1. Introduction.....	30
4.2. Relationship Between the Discharge Coefficient $C_d$ and the Related Dimensionless Parameters .....	30
4.3. Relationship Between the Water Capture Efficiency (WCE) and the Related Dimensionless Parameters.....	36
4.4. Sediment Capture Efficiency and Its Effect on the Water Capture Efficiency .....	41
4.5. Variation of the Dimensionless Wetted Rack Length, $L_2/e$ , with $(F_r)_e$ and $\theta$ .....	49
4.6. Comparison of $C_d$ Values of This Study with Those Obtained From Subramanya's Equation.....	51
5. CONCLUSIONS AND THE FURTHER RECOMMENDATIONS .....	53
REFERENCES.....	55
APPENDICES .....	
APPENDIX A .....	56
MEASURED AND CALCULATED PARAMETERS FOR THE EXPERIMENTS CONDUCTED WITH THE TRASH RACKS OF DIFFERENT $e$ and $\theta$ .....	56

APPENDIX B .....	86
MEASURED PARAMETERS OF THE EXPERIMENTS CONDUCTED WITH SEDIMENT AND WATER .....	86

## LIST OF TABLES

### TABLES

Table 3.1: Sediment mixture groups in the experiments.....	22
Table 3.2: Schedule of experiments conducted with sediment.....	29
Table 4.1: Comparison of $C_d$ values given by Equation (1.4 ) and Equation (2.5).....	52
Table A.1: Measured and calculated parameters for the experiments Conducted with the trash rack of $e_1$ and $\theta_1$ .....	57
Table A.2: Measured and calculated parameters for the experiments Conducted with the trash rack of $e_1$ and $\theta_2$ .....	61
Table A.3: Measured and calculated parameters for the experiments Conducted with the trash rack of $e_1$ and $\theta_3$ .....	65
Table A.4: Measured and calculated parameters for the experiments Conducted with the trash rack of $e_1$ and $\theta_1$ .....	68
Table A.5: Measured and calculated parameters for the experiments Conducted with the trash rack of $e_2$ and $\theta_2$ .....	71
Table A.6: Measured and calculated parameters for the experiments Conducted with the trash rack of $e_2$ and $\theta_3$ .....	74
Table A.7: Measured and calculated parameters for the experiments Conducted with the trash rack of $e_3$ and $\theta_1$ .....	77
Table A.8: Measured and calculated parameters for the experiments Conducted with the trash rack of $e_3$ and $\theta_2$ .....	80

Table A.9: Measured and calculated parameters for the experiments Conducted with the trash rack of $e_3$ and $\theta_3$ .....	83
Table B.1: Measured parameters of the experiment no: 1 conducted with sediment on trash rack of ( $e_1$ , $\theta_1$ and $L_a$ ).....	87
Table B.2: Measured parameters of the experiment no: 2 conducted with sediment on trash rack of ( $e_1$ , $\theta_1$ and $L_a$ ).....	87
Table B.3: Measured parameters of the experiment no: 1 conducted with sediment on trash rack of ( $e_1$ , $\theta_1$ and $L_b$ ).....	88
Table B.4: Measured parameters of the experiment no: 2 conducted with sediment on trash rack of ( $e_1$ , $\theta_1$ and $L_b$ ).....	88
Table B.5: Measured parameters of the experiment no: 1 conducted with sediment on trash rack of ( $e_1$ , $\theta_1$ and $L_c$ ).....	89
Table B.6: Measured parameters of the experiment no: 2 conducted with sediment on trash rack of ( $e_1$ , $\theta_1$ and $L_c$ ).....	89
Table B.7: Measured parameters of the experiment no: 1 conducted with sediment on trash rack of ( $e_1$ , $\theta_2$ and $L_a$ ).....	90
Table B.8: Measured parameters of the experiment no: 2 conducted with sediment on trash rack of ( $e_1$ , $\theta_2$ and $L_a$ ).....	90
Table B.9: Measured parameters of the experiment no: 1 conducted with sediment on trash rack of ( $e_1$ , $\theta_2$ and $L_b$ ).....	91
Table B.10: Measured parameters of the experiment no: 2 conducted with sediment on trash rack of ( $e_1$ , $\theta_2$ and $L_b$ ).....	91
Table B.11: Measured parameters of the experiment no: 1 conducted with sediment on trash rack of ( $e_1$ , $\theta_2$ and $L_c$ ).....	92
Table B.12: Measured parameters of the experiment no: 2 conducted with sediment on trash rack of ( $e_1$ , $\theta_2$ and $L_c$ ).....	92

Table B.13: Measured parameters of the experiment no: 1 conducted with sediment on trash rack of ( $e_1$ , $\theta_3$ and $L_a$ ).....	93
Table B.14: Measured parameters of the experiment no: 2 conducted with sediment on trash rack of ( $e_1$ , $\theta_3$ and $L_a$ ).....	93
Table B.15: Measured parameters of the experiment no: 1 conducted with sediment on trash rack of ( $e_1$ , $\theta_3$ and $L_b$ ).....	94
Table B.16: Measured parameters of the experiment no: 2 conducted with sediment on trash rack of ( $e_1$ , $\theta_3$ and $L_b$ ).....	94
Table B.17: Measured parameters of the experiment no: 1 conducted with sediment on trash rack of ( $e_1$ , $\theta_3$ and $L_c$ ).....	95
Table B.18: Measured parameters of the experiment no: 2 conducted with sediment on trash rack of ( $e_1$ , $\theta_3$ and $L_c$ ).....	95
Table B.19: Measured parameters of the experiment no: 1 conducted with sediment on trash rack of ( $e_2$ , $\theta_1$ and $L_a$ ).....	96
Table B.20: Measured parameters of the experiment no: 2 conducted with sediment on trash rack of ( $e_2$ , $\theta_1$ and $L_a$ ).....	96
Table B.21: Measured parameters of the experiment no: 1 conducted with sediment on trash rack of ( $e_2$ , $\theta_1$ and $L_b$ ).....	97
Table B.22: Measured parameters of the experiment no: 2 conducted with sediment on trash rack of ( $e_2$ , $\theta_1$ and $L_b$ ).....	97
Table B.23: Measured parameters of the experiment no: 1 conducted with sediment on trash rack of ( $e_2$ , $\theta_1$ and $L_c$ ).....	98
Table B.24: Measured parameters of the experiment no: 2 conducted with sediment on trash rack of ( $e_2$ , $\theta_1$ and $L_c$ ).....	98
Table B.25: Measured parameters of the experiment no: 1 conducted with sediment on trash rack of ( $e_2$ , $\theta_2$ and $L_a$ ).....	99

Table B.26: Measured parameters of the experiment no: 2 conducted with sediment on trash rack of ( $e_2$ , $\theta_2$ and $L_a$ ).....	99
Table B.27: Measured parameters of the experiment no:1 conducted with sediment on trash rack of ( $e_2$ , $\theta_2$ and $L_b$ ).....	100
Table B.28: Measured parameters of the experiment no: 2 conducted with sediment on trash rack of ( $e_2$ , $\theta_2$ and $L_b$ ).....	100
Table B.29: Measured parameters of the experiment no: 1 conducted with sediment on trash rack of ( $e_2$ , $\theta_2$ and $L_c$ ).....	101
Table B.30: Measured parameters of the experiment no: 2 conducted with sediment on trash rack of ( $e_2$ , $\theta_2$ and $L_c$ ).....	101
Table B.31: Measured parameters of the experiment no: 1 conducted with sediment on trash rack of ( $e_2$ , $\theta_3$ and $L_a$ ).....	102
Table B.32: Measured parameters of the experiment no: 2 conducted with sediment on trash rack of ( $e_2$ , $\theta_3$ and $L_a$ ).....	102
Table B.33: Measured parameters of the experiment no: 1 conducted with sediment on trash rack of ( $e_2$ , $\theta_3$ and $L_b$ ).....	103
Table B.34: Measured parameters of the experiment no: 2 conducted with sediment on trash rack of ( $e_2$ , $\theta_3$ and $L_b$ ).....	103
Table B.35: Measured parameters of the experiment no: 1 conducted with sediment on trash rack of ( $e_2$ , $\theta_3$ and $L_c$ ).....	104
Table B.36: Measured parameters of the experiment no: 2 conducted with sediment on trash rack of ( $e_2$ , $\theta_3$ and $L_c$ ).....	104
Table B.37: Measured parameters of the experiment no: 1 conducted with sediment on trash rack of ( $e_3$ , $\theta_1$ and $L_a$ ).....	105
Table B.38: Measured parameters of the experiment no: 2 conducted with sediment on trash rack of ( $e_3$ , $\theta_1$ and $L_a$ ).....	105



Table B.39: Measured parameters of the experiment no: 1 conducted with sediment on trash rack of ( $e_3$ , $\theta_1$ and $L_b$ ).....	106
Table B.40: Measured parameters of the experiment no: 2 conducted with sediment on trash rack of ( $e_3$ , $\theta_1$ and $L_b$ ).....	106
Table B.41: Measured parameters of the experiment no: 1 conducted with sediment on trash rack of ( $e_3$ , $\theta_1$ and $L_c$ ).....	107
Table B.42: Measured parameters of the experiment no: 2 conducted with sediment on trash rack of ( $e_3$ , $\theta_1$ and $L_c$ ).....	107
Table B.43: Measured parameters of the experiment no: 1 conducted with sediment on trash rack of ( $e_3$ , $\theta_2$ and $L_a$ ).....	108
Table B.44: Measured parameters of the experiment no: 2 conducted with sediment on trash rack of ( $e_3$ , $\theta_2$ and $L_a$ ).....	108
Table B.45: Measured parameters of the experiment no: 1 conducted with sediment on trash rack of ( $e_3$ , $\theta_2$ and $L_b$ ).....	109
Table B.46: Measured parameters of the experiment no: 2 conducted with sediment on trash rack of ( $e_3$ , $\theta_2$ and $L_b$ ).....	109
Table B.47: Measured parameters of the experiment no: 1 conducted with sediment on trash rack of ( $e_3$ , $\theta_2$ and $L_c$ ).....	110
Table B.48: Measured parameters of the experiment no: 2 conducted with sediment on trash rack of ( $e_3$ , $\theta_2$ and $L_c$ ).....	110
Table B.49: Measured parameters of the experiment no: 1 conducted with sediment on trash rack of ( $e_3$ , $\theta_3$ and $L_a$ ).....	111
Table B.50: Measured parameters of the experiment no: 2 conducted with sediment on trash rack of ( $e_3$ , $\theta_3$ and $L_a$ ).....	111
Table B.51: Measured parameters of the experiment no: 1 conducted with sediment on trash rack of ( $e_3$ , $\theta_3$ and $L_b$ ).....	112

Table B.52: Measured parameters of the experiment no: 2 conducted with sediment on trash rack of ( $e_3$ , $\theta_3$ and $L_b$ ).....	112
Table B.53: Measured parameters of the experiment no: 1 conducted with sediment on trash rack of ( $e_3$ , $\theta_3$ and $L_c$ ).....	113
Table B.54: Measured parameters of the experiment no: 2 conducted with sediment on trash rack of ( $e_3$ , $\theta_3$ and $L_c$ ).....	113

## LIST OF FIGURES

### FIGURES

Figure 1.1: A typical Tyrolean weir and its screen .....	2
Figure 1.2: Types of rack bars with different profiles .....	3
Figure 1.3: Definition sketch for wetted rack lengths $L_1$ and $L_2$ of a Tyrolean screen.....	6
Figure 2.1: Definition sketch for a Tyrolean weir.....	12
Figure 3.1: Plan and Section Views of Tyrolean Weir Model Constructed (lengths are in cm) .....	16
Figure 3.2: General view of the Tyrolean weir model.....	17
Figure 3.3: Photograph of the main channel taken from downstream .....	17
Figure 3.4: Side view of the trash rack and the collection channel.....	18
Figure 3.5: Side channel with rectangular sharp-crested weir at downstream end .....	19
Figure 3.6: Tyrolean screen with $e_1 = 3$ mm clear distance between bars (clean and clogged after the experiment) .....	20
Figure 3.7: Tyrolean screen with $e_2 = 6$ mm clear distance between bars (clean and clogged during the experiment) .....	21

Figure 3.8: Tyrolean screen with $e_3 = 10$ mm clear distance between bars (clean and clogged after the experiment) .....	21
Figure 3.9: Samples of sediments used in the experiments .....	22
Figure 3.10: Discharge rating curve for the main channel.....	24
Figure 3.11: Discharge rating curve for the side channel.....	25
Figure 4.1: Variation of $C_d$ with $(F_r)_e$ for the Tyrolean screen of $e_1/a_1 = 0.23$ and $\theta_1 = 14.477^\circ$ .....	31
Figure 4.2: Variation of $C_d$ with $(F_r)_e$ for the Tyrolean screen of $e_1/a_1 = 0.23$ and $\theta_2 = 9.594^\circ$ .....	32
Figure 4.3: Variation of $C_d$ with $(F_r)_e$ for the Tyrolean screen of $e_1/a_1 = 0.23$ and $\theta_3 = 4.780^\circ$ .....	32
Figure 4.4: Variation of $C_d$ with $(F_r)_e$ for the Tyrolean screen of $e_2/a_2 = 0.375$ and $\theta_1 = 14.477^\circ$ .....	33
Figure 4.5: Variation of $C_d$ with $(F_r)_e$ for the Tyrolean screen of $e_2/a_2 = 0.375$ and $\theta_2 = 9.594^\circ$ .....	33
Figure 4.6: Variation of $C_d$ with $(F_r)_e$ for the Tyrolean screen of $e_2/a_2 = 0.375$ and $\theta_3 = 4.780^\circ$ .....	34
Figure 4.7: Variation of $C_d$ with $(F_r)_e$ for the Tyrolean screen of $e_3/a_3 = 0.5$ and $\theta_1 = 14.477^\circ$ .....	34
Figure 4.8: Variation of $C_d$ with $(F_r)_e$ for the Tyrolean screen of $e_3/a_3 = 0.5$ and $\theta_2 = 9.594^\circ$ .....	35
Figure 4.9: Variation of $C_d$ with $(F_r)_e$ for the Tyrolean screen of $e_3/a_3 = 0.5$ and $\theta_3 = 4.780^\circ$ .....	35
Figure 4.10: Water capture efficiencies for Tyrolean screen of $e_1/a_1 = 0.23$ and $\theta_1 = 14.477^\circ$ .....	37

Figure 4.11: Water capture efficiencies for Tyrolean screen of $e_1/a_1 = 0.23$ and $\theta_2 = 9.594^\circ$ .....	37
Figure 4.12: Water capture efficiencies for Tyrolean screen of $e_1/a_1 = 0.23$ and $\theta_3 = 4.780^\circ$ .....	38
Figure 4.13: Water capture efficiencies for Tyrolean screen of $e_2/a_2 = 0.375$ and $\theta_1 = 14.477^\circ$ .....	38
Figure 4.14: Water capture efficiencies for Tyrolean screen of $e_2/a_2 = 0.375$ and $\theta_2 = 9.594^\circ$ .....	39
Figure 4.15: Water capture efficiencies for Tyrolean screen of $e_2/a_2 = 0.375$ and $\theta_3 = 4.780^\circ$ .....	39
Figure 4.16: Water capture efficiencies for Tyrolean screen of $e_3/a_3 = 0.5$ and $\theta_1 = 14.477^\circ$ .....	40
Figure 4.17: Water capture efficiencies for Tyrolean screen of $e_3/a_3 = 0.5$ and $\theta_2 = 9.594^\circ$ .....	40
Figure 4.18: Water capture efficiencies for Tyrolean screen of $e_3/a_3 = 0.5$ and $\theta_3 = 4.780^\circ$ .....	41
Figure 4.19: Sediment capture efficiencies for $e_1 = 3$ mm .....	43
Figure 4.20: Sediment capture efficiencies for $e_2 = 6$ mm .....	43
Figure 4.21: Sediment capture efficiencies for $e_3 = 10$ mm .....	44
Figure 4.22: Water capture efficiencies for $e_1 = 3$ mm.....	44
Figure 4.23: Water capture efficiencies for $e_2 = 6$ mm.....	45
Figure 4.24: Water capture efficiencies for $e_3 = 10$ mm.....	45
Figure 4.25: Variation of $(q_w)_i/(q_w)_T$ with time ( $e_1/a_1 = 0.23$ , $L_a = 20$ cm $\theta_1 = 14.477^\circ$ ) .....	46

Figure 4.26: Variation of $(q_w)_i/(q_w)_T$ with time ( $e_1/a_1 = 0.23$ , $L_b = 40$ cm $\theta_3 = 4.480^\circ$ ).....	46
Figure 4.27: Variation of $(q_w)_i/(q_w)_T$ with time ( $e_2/a_2 = 0.375$ , $L_c = 60$ cm $\theta_1 = 14.477^\circ$ ).....	47
Figure 4.28: Variation of $(q_w)_i/(q_w)_T$ with time ( $e_2/a_2 = 0.375$ , $L_a = 20$ cm $\theta_2 = 9.594^\circ$ ).....	47
Figure 4.29: Variation of $(q_w)_i/(q_w)_T$ with time ( $e_3/a_3 = 0.5$ , $L_b = 40$ cm $\theta_2 = 9.594^\circ$ ).....	48
Figure 4.30: Variation of $(q_w)_i/(q_w)_T$ with time ( $e_3/a_3 = 0.5$ , $L_c = 20$ cm $\theta_3 = 4.480^\circ$ ).....	48
Figure 4.31: Variation of $L_2/e$ with $(F_r)_e$ and $\theta$ for screens of $e_1/a_1 = 0.23$ ..	50
Figure 4.32: Variation of $L_2/e$ with $(F_r)_e$ and $\theta$ for screens of $e_2/a_2 = 0.375$	50
Figure 4.33: Variation of $L_2/e$ with $(F_r)_e$ and $\theta$ for screens of $e_3/a_3 = 0.5$ ....	51

## LIST OF SYMBOLS

$\alpha$	:	Empirical coefficient of Righetti and Lanzoni's equation
$a$	:	Center distance between bars of the Tyrolean screen
$A_{ro}$	:	The net rack opening area per unit width of the rack
$b_0$	:	Empirical coefficient of Righetti and Lanzoni's equation
$b_1$	:	Empirical coefficient of Righetti and Lanzoni's equation
$C_{d0}$	:	Discharge coefficient for a horizontal screen
$C_d$	:	Discharge coefficient for an inclined Tyrolean screen
$e$	:	Clear distance between bars of the Tyrolean screen
$F_{H0}$	:	Modified Froude number
$(F_r)_e$	:	Froude number based on bar spacing
$g$	:	Gravitational acceleration
$h$	:	Flow depth at just upstream of the Tyrolean screen
$h_c, y_c$	:	Critical flow depth at upstream of the Tyrolean screen
$H_0$	:	The energy head of the flow approaching the rack
$H_c$	:	Critical specific energy head of the flow over screen
$L$	:	Length of the Tyrolean screen
$L_1$	:	The distance of the point where the flow nappe crosses the axis of the Tyrolean weir
$L_2$	:	Total wetted rack length
$(q_w)_i$	:	Diverted unit discharge by the Tyrolean screen
$(q_w)_r$	:	Total unit discharge in the main channel
$U_0$	:	The average velocity of the flow approaching the rack
$(V_B)_n$	:	Velocity component of the flow perpendicular to the trash rack at the spacing between two rack bars
$W$	:	Width of the main channel
$y_0$	:	Normal flow depth in the main channel
$\alpha$	:	Angle between the velocity vector $V_B$ and the axis of the rack
$\vartheta_i$	:	Angle of inclination of the screen
$\mu$	:	Contraction coefficient
$\rho_w$	:	Density of water
$\chi$	:	Reduction factor
$\omega$	:	Rack porosity
<b>WCE</b>	:	<b>Water Capture Efficiency</b>

# **CHAPTER 1**

## **INTRODUCTION**

### **1.1 GENERAL**

Hydropower is the most widespread renewable clean energy source in the world. It is a known fact that, according to the predictions of the population growth and industrial development, Turkey will be facing an energy shortage in the next 15 years. Considering the country's hydraulic potential one of the best solutions to this problem is the construction of hydropower plants. Although Turkey is using only a small percentage of its hydropower potential, almost all possible big dams are either in construction or in operation. The rest of the energy is expected to be generated by small hydropower plants. Runoff river intakes are preferred for locations where the existence of a reservoir is not possible. Even if a terrain is available for reservoir construction, run-off river power plants will still be desirable due to their less negative impact on the nature.

The biggest problem of the run-off river power plants is the sediment taken from the river to the facility along with water. Even smallest size of the bed or suspended material can cause serious damages on the parts of a power plant, especially on the turbine blades. Tyrolean weirs are known to be a very suitable solution to separate major part of the sediment in the river flow while it diverts desirable amount of water to the system. Figure 1.1 shows a typical Tyrolean weir with its important components. A Tyrolean



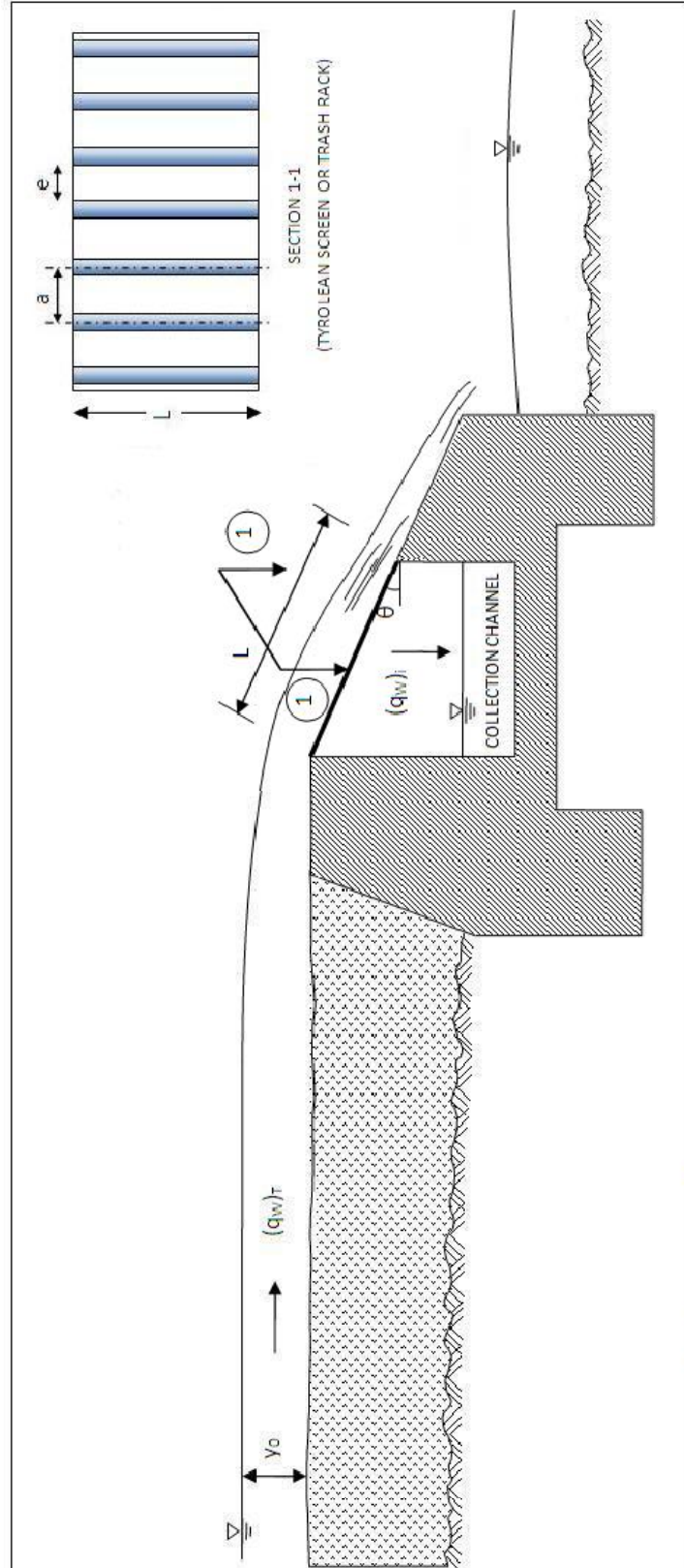

Figure 1.1 A typical Tyrolean weir and its screen

weir is a water inlet structure in which water is abstracted from the main channel through a screen over a collection channel. The collection channel is usually made of concrete and built into the river bed. From the collection channel water enters a sedimentation tank and then flows by gravity into the rest of the system. The bars of the screen or trash rack are laid in the direction of the current and inclined in the direction of the tailwater so that coarse bed material is kept out of the collection channel and transported further downstream. The particles which are smaller than the inside width between the screen bars are introduced into the collection channel together with the water and these must later on be separated from the water for power generation by suitable flushing devices.

In the selection of trash rack type and dimensions, precautions should be taken to prevent clogging of the racks. The basic design variables of a trash rack are the opening between the adjacent bars “e” and the center spacing “a” (Fig. 1.1). These values depend on the size of the material allowed to pass through the intake. Figure 1.2 shows some types of rack bars with different profiles. The rectangular racks are not recommended to be used for intake as they are easily and rapidly clogged by stones (Fig. 1.2a) The bulb-ended bars have better performance and are more rigid if required (Fig 1.2b). Finally the best shape is the round-head bars that prevent sediments from jamming and have better resistance against impact of stones because of higher moment of inertia (Fig. 1.2c).

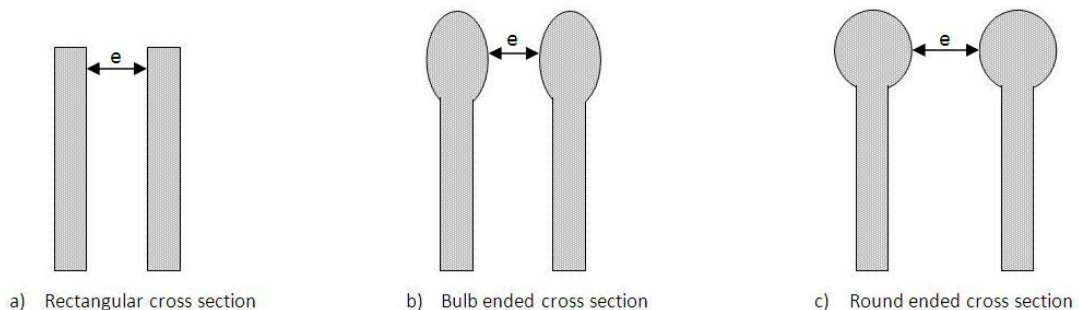

Figure 1.2 Types of rack bars with different profiles (after, Andaroodi M. 2005)

There are several hydraulic characteristics that needed to be examined to decide on a proper design. Tyrolean weir design depends on the total discharge of the river, the desired discharge to be diverted, the characteristics of the bed and suspended load in the river flow and river's physical characteristics (slope, width, soil material etc.).

The aim of this thesis was to investigate the hydraulic and physical conditions necessary to capture the minimum amount of sediment from the river along with the desired amount of diverted water. For this reason a series of experiments were conducted in a hydraulic model of a Tyrolean weir with trash racks having various; lengths, bar spacings and angles of inclinations.

In the next section the literature review conducted on the subject is given. The theoretical study is presented in Chapter II. The experimental setup and details of the experiments are explained in Chapter III. Analysis of the experimental data and discussion of the results are considered in Chapter IV. Conclusions and the further recommendations are given in Chapter V.

**1.2 LITERATURE REVIEW**

Frank (1956) derived the following equation for the trash rack length L which is necessary to provide the unit discharge of  $(q_w)_i$  from the main channel by assuming that there is no energy loss of the flow over the trash rack and the flow depth just before the trash rack is critical (Huber, 2005)

$$L = 2.651 \cdot \frac{(q_w)_i}{\lambda \sqrt{h}} \dots\dots\dots(1.1)$$

where  $\lambda = \Psi \cdot \mu \sqrt{2g \cos \theta}$  ; discharge coefficient

$$\Psi = e/a$$

e = clear distance between the trash rack bars

a = distance between centers of the trash rack bars

$\mu = 0.66 \cdot \Psi^{-0.16} \cdot \left(\frac{a}{h}\right)^{0.13}$ ; contraction coefficient which is function of the shape of the trash rack and the flow depth over the trash rack and valid for trash rack bars having rectangular cross section

h = flow depth at just upstream section of the trash rack taken as perpendicular to the trash rack

$$h = \chi \cdot h_c$$

$\chi$  = reduction factor and calculated from

$$2 \cos \theta \cdot \chi^3 - 3\chi^2 + 1 = 0$$

$\theta$  = angle of the trash rack inclination

$$h_c = \sqrt[3]{\frac{(q_w)_T^2}{g}}$$

critical flow depth and  $(q_w)_T$  is the discharge of the main channel

Assuming that the energy line of the flow over the trash rack is to be parallel to the trash rack, the equation of trash rack length L was given by Nosedá in 1956 as

$$L = 1.185 \cdot \frac{H_c}{\mu_m \Psi} \dots\dots\dots(1.2)$$

where  $H_c$  is the specific energy head of the flow over the trash rack and  $\mu_m = 1.22 \cdot \mu$  is suggested. But this equation neglects the inclination of the rack and thus it is only valid for horizontal racks (Drobir et al. 1999).

Drobir, et al. (1999) conducted a series of experiments on a Tyrolean weir model which had a scale of 1:10 and constructed in the hydraulic laboratory of the University of Technology, Vienna. During this study the wetted rack lengths were measured for four different angles of inclinations (from 0% to 30%), for five different discharges  $[(q_w)_T = 0.25, 0.50, 1.00, 1.50, 2.00 \text{ m}^2/\text{s}]$  and two different clear distances between 10.0 cm diameter bars (10.0 and 15.0 cm). During these experiments two different

lengths; the total wetted rack length ( $L_2$ ) and the distance of the point where the flow nappe crosses the axis of the Tyrolean weir ( $L_1$ ) were measured (Figure 1.3). They compared the measured lengths with those calculated from the equations of Frank (1956) and Nosedá (1956), and concluded that the measured lengths were clearly below the calculated values with high discharges and were above with low discharges

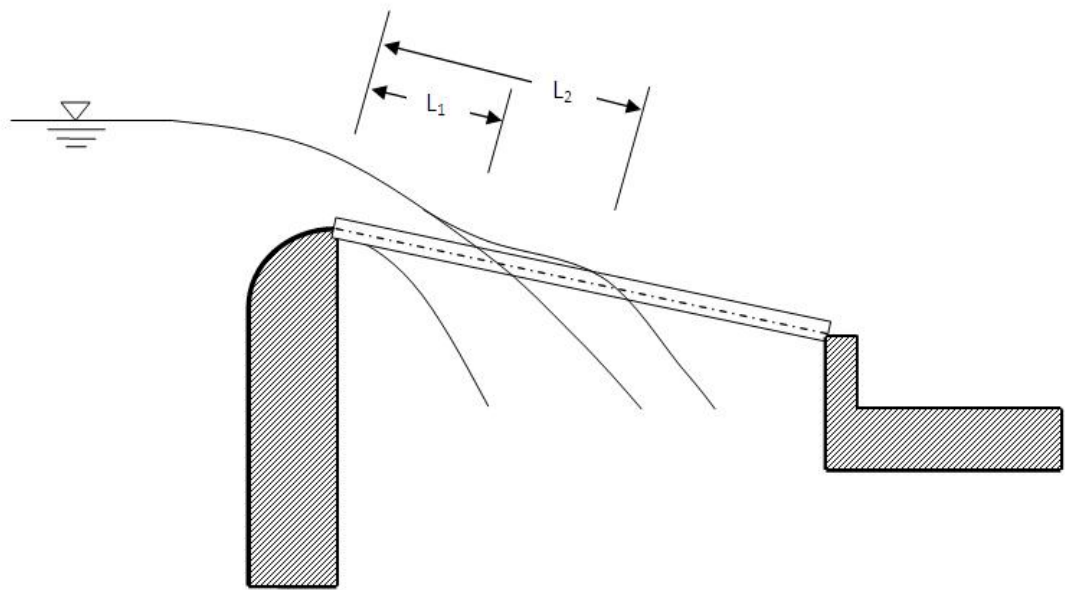

Figure 1.3 Definition sketch for wetted rack lengths  $L_1$  and  $L_2$  of a Tyrolean screen

Brunella, et al. (2003) used the data obtain from a systematic series of experiments to observe the effect of the bottom slope, the rack geometry and the rack porosity on the hydraulics of the bottom rack intake. For experiments a rectangular channel that was 0.5 m in width and 7 m in length was used. The experiments were conducted repeatedly for several different geometries of circular bars that form the bottom rack intake; 12 and 6 mm in diameter, 0.60 m and 0.45 m in length, and 6 mm and 3 mm for clear distances between bars. The angle  $\theta$  of the bottom rack had values of 0, 7, 19, 28, 35, 39, 44 and 51°. During experiments the water surface profiles and velocity distributions along the bottom rack were measured and

it was concluded that free surfaces were almost identical for small and large bottom slopes. Using their own data and some other data from the literature obtained from the tests of ovoid and circular rack profiles Brunella et al. plotted the relative intake length  $C_d \omega_* (L_2/H_c)$  as a function of main channel discharge, and concluded that the relative intake length required for practically 100% intake discharge  $[(q_w)_i = (q_w)_T]$  is

$$C_d \omega (L_2/H_c) = 0.83 \dots \dots \dots (1.3)$$

where  $C_d$  is the discharge coefficient and was found varying between 0.87 and 1.10 as a function of  $\omega$ ,  $\omega$  is the rack porosity corresponding to the ratio of the total net spacing between the rack bars to the main channel width,  $L_2$  is wetted the rack length and  $H_c$  is the critic energy head. It was also stated that the value of  $C_d$  could attain values higher than one as a consequence of the Coando effect arising when bar clearance is small enough (Hager and Minor, 2003).

Ahmad and Mittal (2006) presented the summary of the studies in the field of bottom racks. According to the information given, in 1957 Mostkow, based on limited experimental study as suggested that  $C_d$  varies from 0.435 for a rack sloping as 1 in 5, to 0.497 for a horizontal rack. However, the influence of approach flow and rack geometry was not considered by him. Subramanya in 1994 gave the following expression for  $C_d$  for subcritical approach flow and supercritical flow over the racks of rounded bars

$$C_d = 0.53 + 0.4 \log D/e - 0.61 \tan \theta \dots \dots \dots (1.4)$$

where  $D$  is the diameter of rack bars,  $e$  is the spacing of rack bars and  $\theta$  is the inclination angle of the rack bars.

Ghosh and Ahmad in 2006 studied experimentally the discharge characteristics of flat bars. They found that the specific energy over the rack is almost constant. They also compared  $C_d$  obtained for flat bars with  $C_d$  calculated by Subramanya's relationship, i.e., Eq (1.4). From this comparison it was concluded that two sets of  $C_d$  values are different and Subramanya's relationship overestimates the value of  $C_d$ .

Ghosh and Ahmad proposed the following equation for  $C_d$  for flat bars

$$C_d = 0.1296\left(\frac{t}{e}\right) - 0.4284(\tan \theta)^2 + 0.1764 \dots \dots \dots (1.5)$$

where  $t$  is the thickness of the bars. Equation 1.5 predicts the value of  $C_d$  for that flat bars within  $\pm 10\%$  error. Thus for the design of flat bars bottom rack Eq. 1.5 is recommended. Equation 1.5 is proposed on the basis of limited data range, more experimental and field data are required to propose a better equation (Ahmad and Mittal, 2005).

Ahmad and Mittal (2006) found that the optimum length of bottom rack is obtained when diverted discharge is equal to the incoming discharge in the system.

Righetti and Lanzoni (2008) studied on the problem of hydraulic design of bottom intake racks and tried to derive a physically based relation between the length of rack, the void ratio, the discharge coefficient and the overall diverted discharge. For that purpose a series of experiments were performed in a laboratory flume which was 12 meters in length and 0.25 meters in width and composed of glass windows with steel frames. The bottom rack that was placed on the bottom of the flume had the same slope as the flume and was 0.45 meters in length, and had a void ratio of  $\omega = 0.2$ . During experiments the diverted discharge, the water surface profile in the streamwise direction, the velocity field over the rack and in the slit between two adjacent bars (using a two-dimensional backscatter laser Doppler anemometer) were measured. Using the obtained data several graphs were drawn; water depth profiles along the axis of the flume, the distribution of the velocity vector in a vertical plane and the typical transverse distribution of the vertical component of the velocity in the slit between two adjacent bars. Using the obtained data an equation for the diverted discharge was derived

$$(q_w)_i = C_{d0} \cdot \omega \cdot w \cdot L \cdot \sqrt{2gH_0} \left( \frac{a}{2} \frac{L}{H_0} F_{H_0} + 1 \right) \tanh \dots \dots \dots (1.6)$$

where  $C_{d0}$  is the discharge coefficient for a horizontal bottom rack when the Froude number close to zero and the values varies between 0.95 and 1.00

$w$  is the channel width

$H_0$  is the energy head of the flow approaching the rack

$F_{H_0}$  is the modified Froude number

$$F_{H_0} = \frac{U_0}{\sqrt{g \cdot H_0}} \text{ where } U_0 \text{ is the velocity of the flow approaching the rack}$$

$a = 0.1056$ ,  $b_0 = 1.5$ ,  $b_1 = 0.6093$  are the empirical coefficients.

The agreement between the calculated values from the above equation for  $(q_w)_i$  and those obtained by Nosedá was found to be surprisingly good in spite of the differences between the two independent data sets.

Kamanbedast and Bejestan (2008) conducted a series of experiments on a physical model of a bottom intake in a flume of 60 cm wide, 8 m long and 60 cm high to investigate the effects of slope and area opening on the screen on the amount of diverted discharge. Size models of bottom rack with three different percent of area opening equal to 30, 35 and 40 % using two different sizes of bars equal to 6 and 8 mm were tested. Each model was tested under four different slopes; 10, 20, 30 and 40 %, and five different flow discharges. For constant bar length which was not given it is stated that the ratio of the diverted discharge to the total incoming discharge is function of only area spacing of the bars and the rack slope. From the plot of these variables with respect to each other for the data of only one discharge tested; 24.5 lt/s, the results of the other discharges was not presented, with the bar diameter of 8 mm, three rack slopes and four area spacing, it was concluded that as the slope of rack increases, the discharge ratio increases. However the discharge ratio reaches to a maximum at slope of about 30 % and then the discharge ratio decreases. The maximum discharge ratio which was equal to 0.8, was achieved when the rack opening was 40 % and the slope was 30 %, without giving detailed information about the experiments conducted with sediment; what



sediment load was used and introduced into the flow, it was concluded that the discharge ratio is about 10 % less when the sediment was presented because of clogging the opening area.

## **CHAPTER 2**

### **THEORETICAL STUDY**

#### **2.1 INTRODUCTION**

In this chapter the theoretical studies carried out about the performance of the trash rack of a Tyrolean weir were presented. In the first part, the discharge coefficient, and in the following section the relationship for the water capture efficiency and wetted rack length of the trash rack were derived.

#### **2.2 DERIVATION OF THE DISCHARGE COEFFICIENT FOR TYROLEAN WEIRS**

Referring to the definition sketch given in Figure 2.1 one can write the energy equation for a streamline passing from points A where the flow is critical and B at the spacing between two adjacent rack bars assuming that the energy loss is negligible.

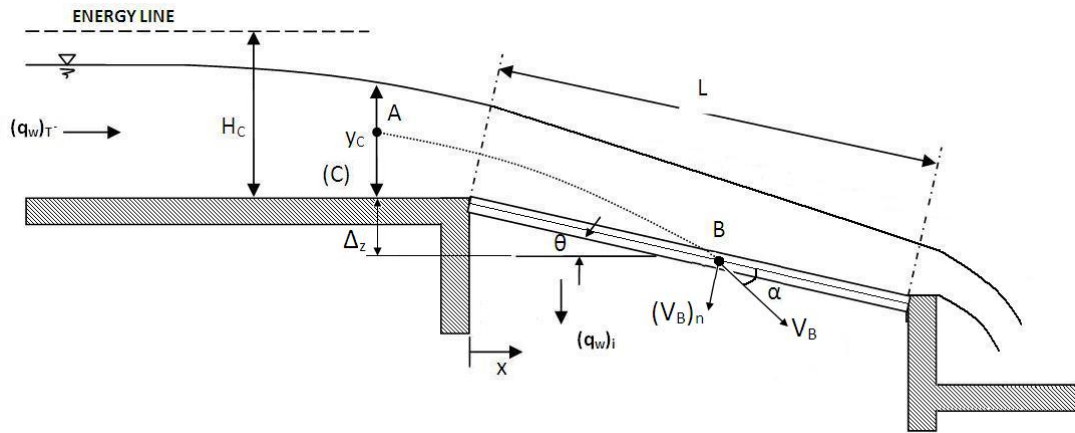

Figure 2.1 Definition sketch for a Tyrolean weir

$$H_C = \frac{V_B^2}{2g} - \Delta z \dots \dots \dots (2.1)$$

where  $\Delta z = x \cdot \tan \theta$  The velocity component of the flow at point B perpendicular to the trash rack is  $(V_B)_n$  and it can be written from the above equation as

$$(V_B)_n = V_B \cdot \sin \alpha = (\sqrt{2g(H_C + \Delta z)}) \sin \alpha = \sin \alpha \sqrt{2gH_C \left(1 + \frac{\Delta z}{H_C}\right)} \dots \dots \dots (2.2)$$

Assuming that  $\Delta z/H_C \ll 1$  especially for small values of  $\theta$  the velocity  $(V_B)_n$  can be written as

$$(V_B)_n \cong \sin \alpha \sqrt{2gH_C} \dots \dots \dots (2.3)$$

The discharge diverted, per unit width, by the bottom rack intake is  $(q_w)_i$ , then results

$$(q_w)_i = A_{ro} (V_B)_n = A_{ro} \sin \alpha \sqrt{2gH_C} \dots \dots \dots (2.4)$$

where  $A_{ro}$  is the net rack opening area per unit width of the trash rack

Equation 2.4 can also be written as

$$(q_w)_i = C_d A_{ro} \sqrt{2gH_C} \dots\dots\dots(2.5)$$

where  $C_d$  is the discharge coefficient and it accounts for all of the assumptions made in the derivation of  $(q_w)_i$  such as, hydrostatic pressure distribution, negligible energy loss, negligible effect of  $\Delta z$  on the velocity component  $(V_B)_n$ , ...etc.

It should be kept in mind that Eq. 2.5 is valid if the approach flow passes over the total length of the trash rack. This condition is satisfied if the total length of the trash rack to be used,  $L$ , is less than or equal to the length  $L_2$  which is the necessary length of the trash rack to divert all of the incoming discharge.

### **2.3 WATER CAPTURE EFFICIENCY AND WETTED RACK LENGTH OF TYROLEAN WEIRS**

For a Tyrolean weir of which the hydraulic and geometric parameters are depicted in Figure 2.1 the following equation for the diverted discharge  $(q_w)_i$  through the bottom racks can be written as a function of the relevant variables, assuming that the screen is composed of circular bars and the effects related to surface tension and fluid compressibility are neglected.

$$(q_w)_i = f [(q_w)_T, e, a, L, \theta, g, \rho_w, ] \dots\dots\dots(2.6)$$

where  $(q_w)_T$  is the total water discharge of the flow approaching the rack per unit channel width,  $e$  is the clear distance between bars,  $a$  is the distance between centers of the trash rack bars,  $L$  is the rack length,  $\theta$  is the angle of inclination of the rack,  $g$  is the gravitational acceleration,  $\rho_w$  is the density of water. Choosing  $(q_w)_T$ ,  $e$  and  $\rho_w$  as the fundamental variables and applying Buckingham's  $\pi$  theorem the following relationship is obtained

$$\frac{(q_w)_i}{(q_w)_T} = f_1 \left[ \frac{(q_w)_T^2}{e^3 g}, \frac{L}{e}, \frac{a}{e}, \theta \right] \dots \dots \dots (2.7)$$

where  $(F_r)_e^2 = \frac{(q_w)_T^2}{e^3 g}$  =square of the Froude number based on bar opening instead of the flow depth  $y_0$ . Equation 2.7 can be written as

$$\frac{(q_w)_i}{(q_w)_T} = f_2 \left[ (F_r)_e, \frac{L}{e}, \frac{a}{e}, \theta \right] \dots \dots \dots (2.8)$$

In a similar way to that explained above, one can write equations for the discharge coefficient  $C_d$  given in Equation 2.5 and wetted rack length  $L_2$  in terms of the relevant parameters as follows

$$C_d = f_3 [(q_w)_T, e, a, L, \theta, g, \rho_w, \dots] \dots \dots \dots (2.9)$$

and

$$L_2 = f_4 [(q_w)_T, e, a, L, \theta, g, \rho_w, \dots] \dots \dots \dots (2.10)$$

The application of the Buckingham's  $\pi$  theorem to the above equations yields

$$C_d = f_5 \left[ (F_r)_e, \frac{L}{e}, \frac{a}{e}, \theta \right] \dots \dots \dots (2.11)$$

and

$$\frac{L_2}{e} = f_6 \left[ (F_r)_e, \frac{a}{e}, \theta \right] \dots \dots \dots (2.12)$$

In Chapter 4, the variation of  $C_d$ ,  $\frac{(q_w)_i}{(q_w)_T}$  and  $\frac{L_2}{e}$  with related dimensionless terms presented in Equations 2.8, 2.11 and 2.12 will be investigated.

## **CHAPTER 3**

### **EXPERIMENTAL SETUP AND PROCEDURE**

#### **3.1 EXPERIMENTAL SETUP**

A physical model was built at the laboratory to investigate the effects of the properties of the Tyrolean screen on water and sediment capture efficiencies of the Tyrolean weirs. The model, shown in Figures 3.1-3.5, consists of a water intake pipe, a reservoir at the head of the main channel, a main channel, water and sediment intake screen, a side channel with a sediment reservoir located just upstream and downstream channel. The water is supplied from a large elevated-constant head tank to the water intake pipe which is 30 cm in diameter and has a mechanical valve at the end to control the discharge directed to the reservoir. An ultrasonic flow meter was placed on the water intake pipe to measure the total discharge given to the system. The intake pipe directs water to a reservoir at the head of the main channel which is in 2.0 m length 2.0 m width and 1.5 m height. From this reservoir, after having the water passed through a filter layer formed by bricks to reduce its turbulence, water was directed to the main channel. At a location about 1 meter downstream from the inlet section of the main channel a manometer was placed on the side wall of the model to measure the water depth in the main channel. The main channel is 1.98 m in width, 7.0 m in length, and has a slope of  $S_0 = 0.001$ .

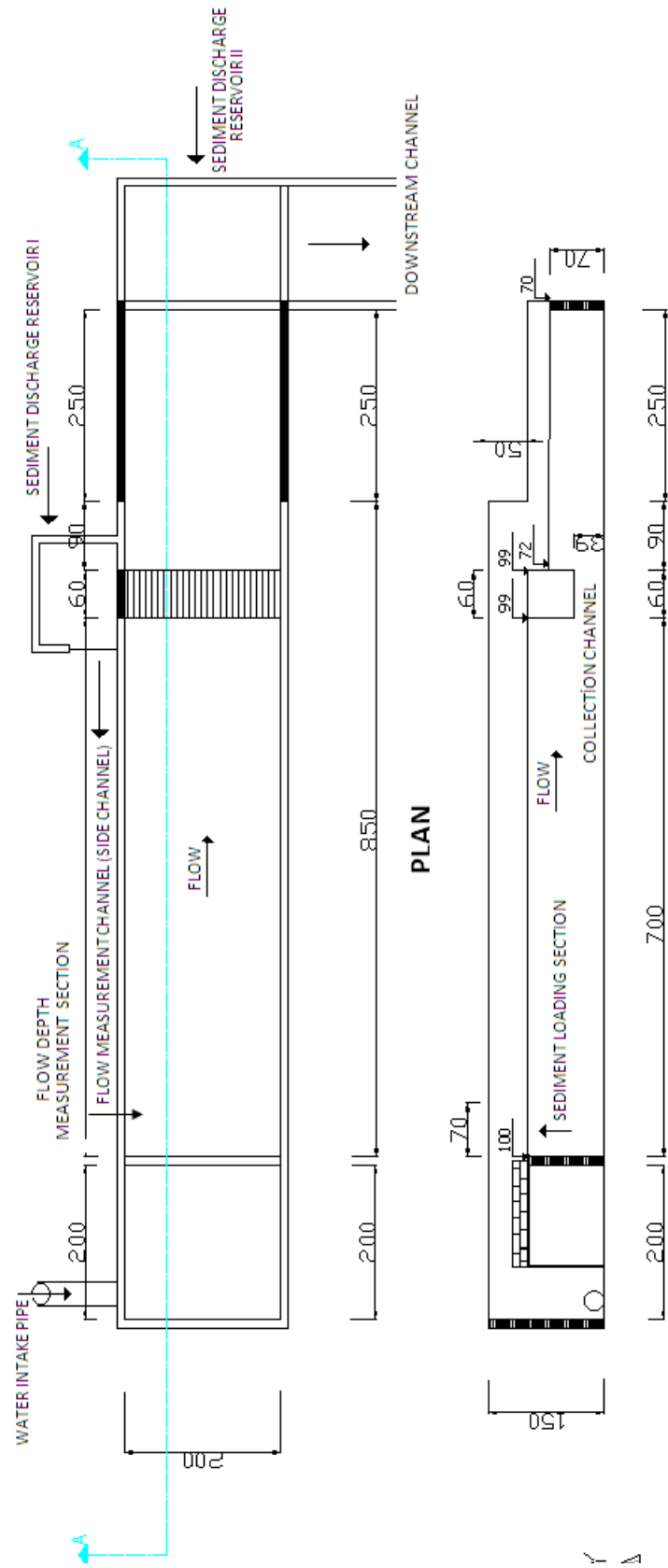

Figure 3.1 Plan and section views of the Tyrolean weir model constructed (the lengths are in cm)



Figure 3.2 General view of the Tyrolean weir model

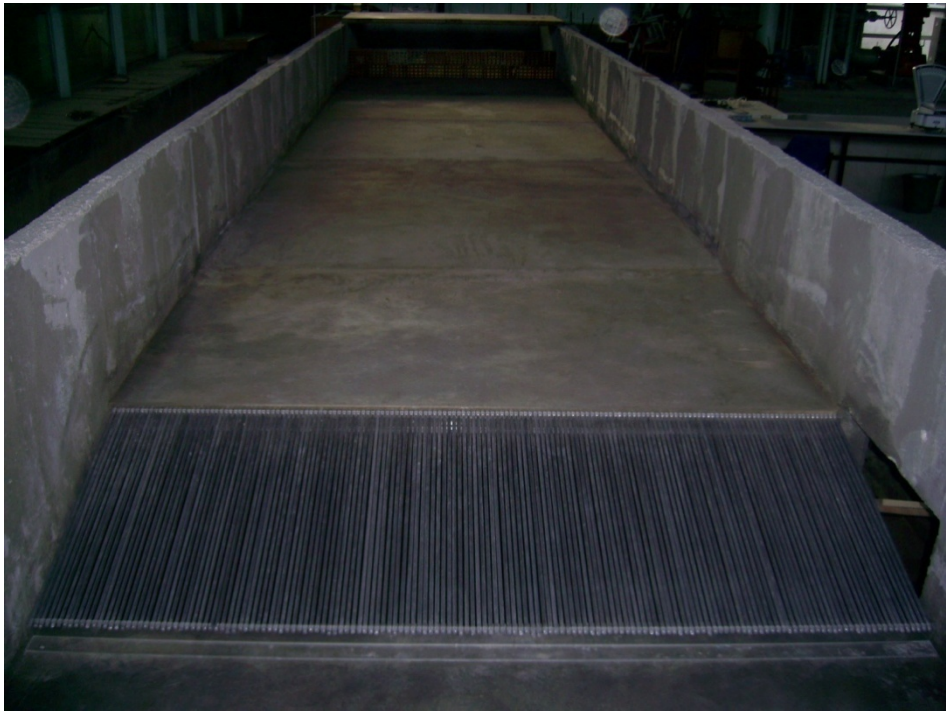

Figure 3.3 Photograph of the main channel taken from downstream





Figure 3.4 Side view of the trash rack and the collection channel



Figure 3.5 Side channel with rectangular sharp-crested weir at downstream end

The Tyrolean screen was placed at the downstream end of the main channel. The elevation difference between upstream and downstream sections of the screen is 27 cm. The screen was made of metal bars of circular cross section that are 1 cm in diameter. The experiments with/without sediment were repeated for three clear distances between bars ( $e_1 = 3$  mm,  $e_2 = 6$  mm and  $e_3 = 10$  mm) and for three angles of inclination ( $\theta_1 = 14.477^\circ$ ,  $\theta_2 = 9.594^\circ$  and  $\theta_3 = 4.780^\circ$ ). Figures 3.6-3.8 show the photography of the screens used in the experiments. The collection channel located under the Tyrolean screen is 1.98 m in length 0.60 m in width, 0.33 cm in height at the downstream side and has a bottom slope of 10%. Water and sediment coming into the intake structure are directed to the sediment trap reservoir I by means of this channel. To keep the incoming sediment within this reservoir there is a 0.20 m high portable barrier at the downstream end of the reservoir. The water coming from the collection channel flows through the side channel which is 0.70 m in width and 6.5 m in length.



Figure 3.6 Tyrolean screen with  $e_1 = 3$  mm clear distance between bars (clean and clogged after the experiment)



Figure 3.7 Tyrolean screen with  $e_2 = 6$  mm clear distance between bars (clean and clogged during the experiment)



Figure 3.8 Tyrolean screen with  $e_3 = 10$  mm clear distance between bars (clean and clogged during the experiment)

To determine the sediment capture efficiencies of the screens three different sediment mixtures were prepared using sediment of 50 kgf weight having the size ranges as stated in Table 3.1. Sediment mixture groups of 1, 2 and 3 were used in the experiments of screens having the bar spacings of  $e_1 = 3$  mm,  $e_2 = 6$  mm and  $e_3 = 10$  mm, respectively. As seen in Table 3.1 in each sediment mixture group there was 50 kgf sediment with sediment sizes larger than the tested screen bar spacing to observe the effect of clogging of the screen on the water and sediment capture efficiency of the system. Figure 3.9 shows the photograph of some samples of the sediment groups.

Table 3.1 Sediment mixture groups used in the experiments

Sediment mixture Group	Weight of the sediment (kgf)				Total weight of the sediment mixture group (kgf)	Bar spacing of the screen Tested, e (mm)
	Size range 0 - 3 (mm)	Size range 3 - 6 (mm)	Size range 6 - 9 (mm)	Size range 10 - 15 (mm)		
1	50	50	50	-	150	3
2	50	50	50	50	200	6
3	50	50	50	50	200	10



Figure 3.9 Samples of sediments used in the experiments

## **3.2 EXPERIMENTAL PROCEDURE**

### **3.2.1 Discharge Measurements**

After construction of the model and installation of the sharp-crested weir, first a set of experiments was conducted to obtain the calibration curves for the main channel and side channel. At the beginning, without placing the screen in its place, a small discharge was given to the system and then about 6 - 10 minutes later the flow depths at the upstream section of the main channel and at the downstream section of the side channel before the sharp-crested weir were measured. Then the discharge was increased gradually with little increments using the valve at the end of the intake pipe so that all of the incoming flow was falling into the collection channel and then going towards the side channel, and above stated depth measurements were repeated after having the flow in both channels stabilized. The discharge of the main channel was measured directly using the records of the acoustic flow meter located on the intake pipe and then correlated with the measured upstream flow depth (Figure 3.10). The discharge of the side channel was taken from the records of the acoustic flow meter and then correlated with the head measurements recorded from the side channel

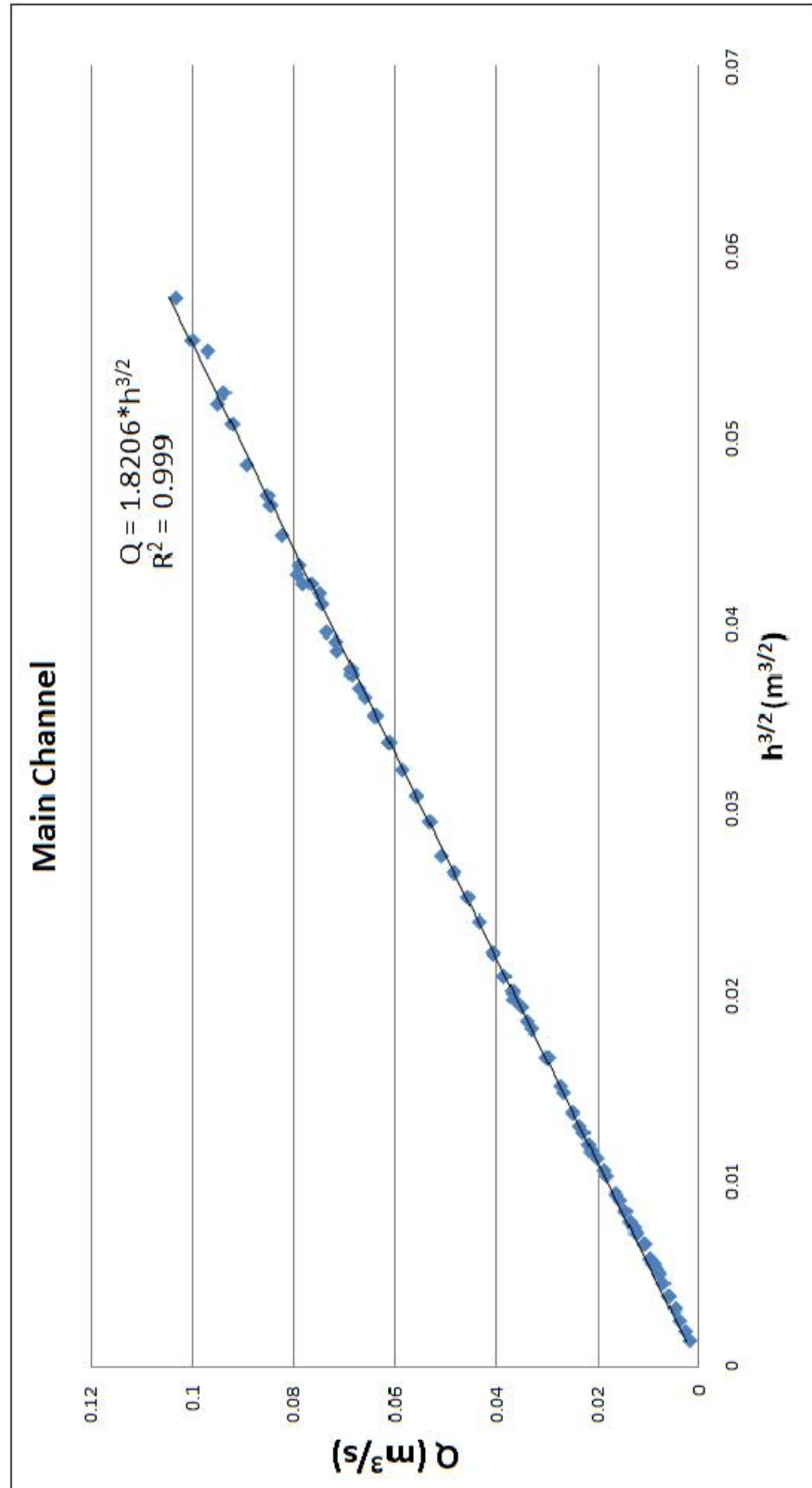

figure 3.10 Discharge rating curve for the main channel

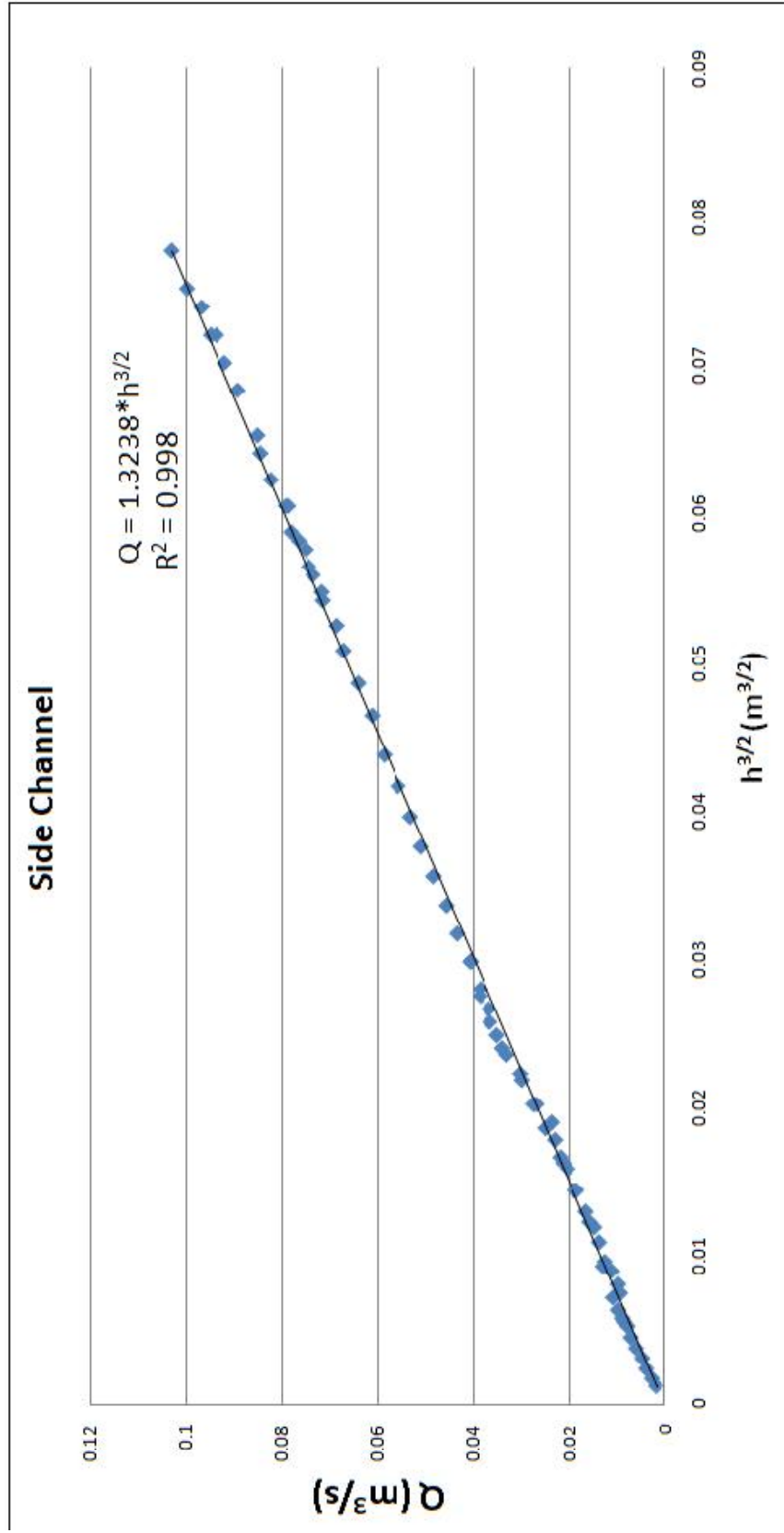

Figure 3.1.1 Discharge rating curve for the side channel



weir (Figure 3.11). Using the collected data the flow rating curves of the main channel and side channel were plotted.

### **3.2.2 Measurements of the Wetted Rack Lengths**

The next set of experiments was conducted to measure the wetted rack lengths. After having the selected Tyrolean screen located in place, by opening the discharge valve slowly the flow depth at the upstream section of the main channel was kept at about 3.0 cm. When water level was stabled, two lengths ( $L_1$ ,  $L_2$ ) at 8 different bars were measured and their mean values were determined (Fig. 1.3). “At the point where the surface of the water nape crossed the axis of the rack bar the length  $L_1$  was read. At the point where the discharge eventually came off the bar, the length  $L_2$  was read” (Drobir, et al. 1999). The maximum variation between these measured lengths along 8 bars was found to be always less than 1.5 cm. The values of  $L_2$  used in the analysis were presented in Appendix A. After the measurements of  $L_1$  and  $L_2$  lengths for 8 bars, the similar measurements were done for increased discharges in the main channel corresponding to the flow depths of 4 cm, 5 cm,... up to 15 cm at the flow measurement section of the main channel. This procedure was repeated for three angles of rack inclination ( $\theta_1 = 14.477^\circ$ ,  $\theta_2 = 9.594^\circ$  and  $\theta_3 = 4.780^\circ$ ) for each clear distances between bars ( $e_1 = 3$  mm,  $e_2 = 6$  mm and  $e_3 = 10$  mm).

### **3.2.3 Measurements of the Water Capture Efficiencies**

The aim of the following series of experiments was to determine the water capture efficiencies,  $[(Q_W)_i / (Q_W)_T]$ , for the given Tyrolean screen lengths ( $x / L_2$ ). To obtain partial openings at the selected screens, the surface area of the screens were covered at desired lengths with a thin steel plate from downstream towards upstream. For the Tyrolean screen with 3 mm clear distance between bars, the first opening was 10 cm. As in the case of the previous experiment after placing the screen and the steel plate, the valve was opened to give the system a discharge corresponding to 3 cm flow depth in the main channel. Using the manometer readings in the main channel and side channel the total discharge and the discharge of the side channel,

respectively, were calculated by means of the rating curves derived earlier. The manometer readings were recorded for each 1 cm increment in the flow depth at the main channel until 15 cm flow depth was reached. After completing the experiment of the initial screen length, the screen length was increased to 15 cm. The experiments were repeated with 5 cm increments in the screen length until the total discharge corresponds to 15 cm flow depth in the main channel was diverted by the Tyrolean screen. The experimental procedure was similar for each screen having different angle of inclination. For the Tyrolean screens with  $e_2 = 6$  mm and  $e_3 = 10$  mm clear distances between bars, the first screen length was selected to be 5 cm since the wetted rack lengths were shortened drastically. Then again the increments of the screen lengths were taken as 5 cm. All of the measured quantities were presented in Appendix A.

#### **3.2.4 Experiments Conducted with Sediment**

The last group of experiments was conducted with sediment. The purpose of this group of experiments was to obtain the effects of clear distance between bars, angle of inclination of the screen and screen length on the sediment and water capture efficiencies. After the preparation of the required sediment mixture group (Table 3.1), it was placed at the upstream end of the main channel in a form of uniform heap and then the selected Tyrolean screen was arranged with/without steel plate placed on it. After that water was given to the model so that the discharge would be about 10 L/s. During these experiments the ultrasonic flow meter placed at the inflow pipe was used to measure the total discharge given to the setup. To calculate the diverted discharge from the weir the manometer reading at the side channel was used. The total discharge of 10 L/s was given to the system for about 4 minutes and then the discharge is gradually increased to 30 L/s and was kept at that value for another 4 minutes. The experiments were continued with an increment of 20 L/s discharge after every 4 minutes to create an artificial flood regime until all the material in the main channel would be carried with the flow. The experiments with the Tyrolean screen having 3 mm clear distance between bars took about 28 minutes in the total. At each case before increasing the main channel discharge, the diverted discharge

in the side channel, main channel discharge and time duration were recorded. The experiments with other screens took about 32 minutes in the total. After completing one experiment, the total amount of sediment captured into the collection channel and sediment collection reservoir I was weighted and the corresponding sediment capture efficiency of the screen tested,  $(q_s)_i/(q_s)_T$  was determined. With the same sediment mixture group the experiments were repeated two times and then their final  $(q_s)_i/(q_s)_T$  values were averaged to determine the sediment capture efficiency of that sediment mixture group. Measured and calculated parameters of the experiments conducted with sediment were given in Appendix B. The experiments were conducted for 3 Tyrolean screens,  $e_1 = 3$  mm,  $e_2 = 6$  mm and  $e_3 = 10$  mm, 3 angles of rack inclination for each screen,  $\theta_1 = 14.477^\circ$ ,  $\theta_2 = 9.594^\circ$  and  $\theta_3 = 4.780^\circ$ , and 3 rack lengths for each inclination,  $L_a = 20$  cm,  $L_b = 40$  cm and  $L_c = 60$  cm. During the experiments conducted with the Tyrolean screen having  $e_3 = 10$ mm clear distance between bars it was observed that the heaps of the accumulated sediment remained on the Tyrolean screen for cases of  $L_b = 40$  cm and  $L_c = 60$  cm; because the screen was able to divert almost the total of the incoming water for the largest discharges. Clogging of the spaces between the bars with sand and gravel were observed at each experiment conducted with sediment (Figs. 3.6 – 3.8) The schedule for the last group of experiments is given in Table 3.2

### **3.2.5 Uncertainty Analysis**

There are some errors expected due to the apparatus used. The manometers placed at the channels are in mm precision. 1 mm misreading gives 0.04 lt/s error for the side channel and 0.058 lt/s error for the main channel. From the acoustic flowmeter the velocity at the water intake pipe is read. 0.01 m/s misreading gives 0.71 lt/s error which is 7.1 % for the smallest discharge (10 lt/s) and 0.47 % for the largest discharge (150 lt/s).

Table 3.2 Schedule of the experiments conducted with sediment

Symbol of the screen type tested	Bar Spacing (mm)	Angle of bar inclination (°)	Tyrolean screen length (cm)	Sediment load (kgf)
$e_1 \theta_1 L_a$	$e_1 = 3$	$\theta_1 = 14.477^\circ$	$L_a = 20$	150
$e_1 \theta_1 L_b$			$L_b = 40$	150
$e_1 \theta_1 L_c$			$L_c = 60$	150
$e_1 \theta_2 L_a$		$\theta_2 = 9.594^\circ$	$L_a = 20$	150
$e_1 \theta_2 L_b$			$L_b = 40$	150
$e_1 \theta_2 L_c$			$L_c = 60$	150
$e_1 \theta_3 L_a$		$\theta_3 = 4.780^\circ$	$L_a = 20$	150
$e_1 \theta_3 L_b$			$L_b = 40$	150
$e_1 \theta_3 L_c$			$L_c = 60$	150
$e_2 \theta_1 L_a$	$e_2 = 6$	$\theta_1 = 14.477^\circ$	$L_a = 20$	200
$e_2 \theta_1 L_b$			$L_b = 40$	200
$e_2 \theta_1 L_c$			$L_c = 60$	200
$e_2 \theta_2 L_a$		$\theta_2 = 9.594^\circ$	$L_a = 20$	200
$e_2 \theta_2 L_b$			$L_b = 40$	200
$e_2 \theta_2 L_c$			$L_c = 60$	200
$e_2 \theta_3 L_a$		$\theta_3 = 4.780^\circ$	$L_a = 20$	200
$e_2 \theta_3 L_b$			$L_b = 40$	200
$e_2 \theta_3 L_c$			$L_c = 60$	200
$e_3 \theta_1 L_a$	$e_3 = 10$	$\theta_1 = 14.477^\circ$	$L_a = 20$	200
$e_3 \theta_1 L_b$			$L_b = 40$	200
$e_3 \theta_1 L_c$			$L_c = 60$	200
$e_3 \theta_2 L_a$		$\theta_2 = 9.594^\circ$	$L_a = 20$	200
$e_3 \theta_2 L_b$			$L_b = 40$	200
$e_3 \theta_2 L_c$			$L_c = 60$	200
$e_3 \theta_3 L_a$		$\theta_3 = 4.780^\circ$	$L_a = 20$	200
$e_3 \theta_3 L_b$			$L_b = 40$	200
$e_3 \theta_3 L_c$			$L_c = 60$	200

## **CHAPTER 4**

### **ANALYSIS OF THE EXPERIMENTAL DATA AND DISCUSSION OF THE RESULTS**

#### **4.1 INTRODUCTION**

In this chapter the analysis of the data of discharge coefficient, water and sediment capture efficiencies and wetted rack length obtained from the experiments conducted in this study were presented.

#### **4.2 RELATIONSHIP BETWEEN THE DISCHARGE COEFFICIENT $C_d$ AND THE RELATED DIMENSIONLESS PARAMETERS**

Equation 2.5 gives the relation between  $C_d$  and other relevant dimensionless terms. When the variation of  $C_d$  with  $(F_r)_e$  and  $L/e$  is plotted one by one for each test conducted (Figs 4.1 – 4.9) it is seen that almost in each figure the data points of a given  $L/e$  follow the same trend, as  $(F_r)_e$  increases,  $C_d$  values gradually increases and attain maximum  $C_d$  values at the largest  $(F_r)_e$ . In each figure stated above there are 5 – 7 data sets corresponding to a certain value of  $L/e$ . Only the first two curves, connecting the data of the first two small  $L/e$  lying on top of the figures show slightly different trends.  $C_d$  values of these curves first rapidly increase and attain maximum  $C_d$  values and then either decreases with increasing  $(F_r)_e$  or follow a horizontal trend. Maximum  $C_d$  values are obtained almost all the time at these small  $L/e$  values regardless of the screen type and slope tested. For a given  $(F_r)_e$  it

is clearly seen from the figures that  $C_d$  value increases as  $L/e$  decreases. From the comparison of the related figures it can be stated that if the angle of inclination of a selected screen increases while keeping  $(F_r)_e$  and  $L/e$  values constant,  $C_d$  value slightly decreases at small values of  $L/e$  while almost remains the same at larger values of  $L/e$ . For constant values of  $(F_r)_e$  and  $L/e$  if the bar spacing of a screen of given  $\theta$  increases,  $C_d$  values decrease. Finally looking at each figure one can conclude that the experimental setup having the smallest  $L/e$  gives the largest  $C_d$  values almost for the total range of  $(F_r)_e$  tested.

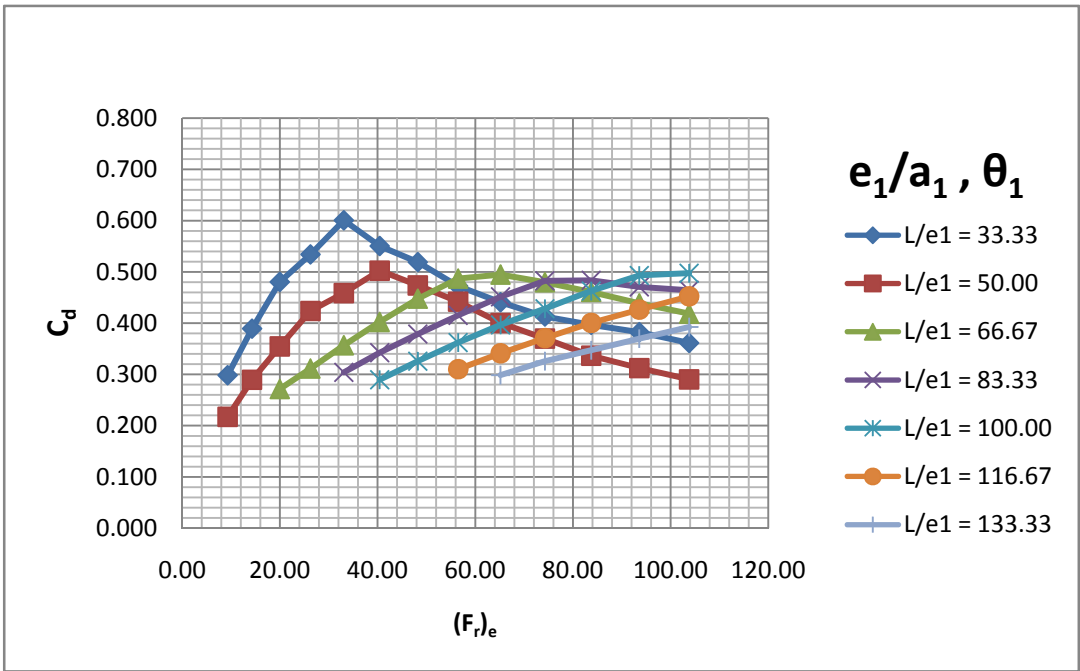

Figure 4.1 Variation of  $C_d$  with  $(F_r)_e$  for the Tyrolean screen of  $e_1/a_1 = 0.23$  and  $\theta_1 = 14.477^\circ$

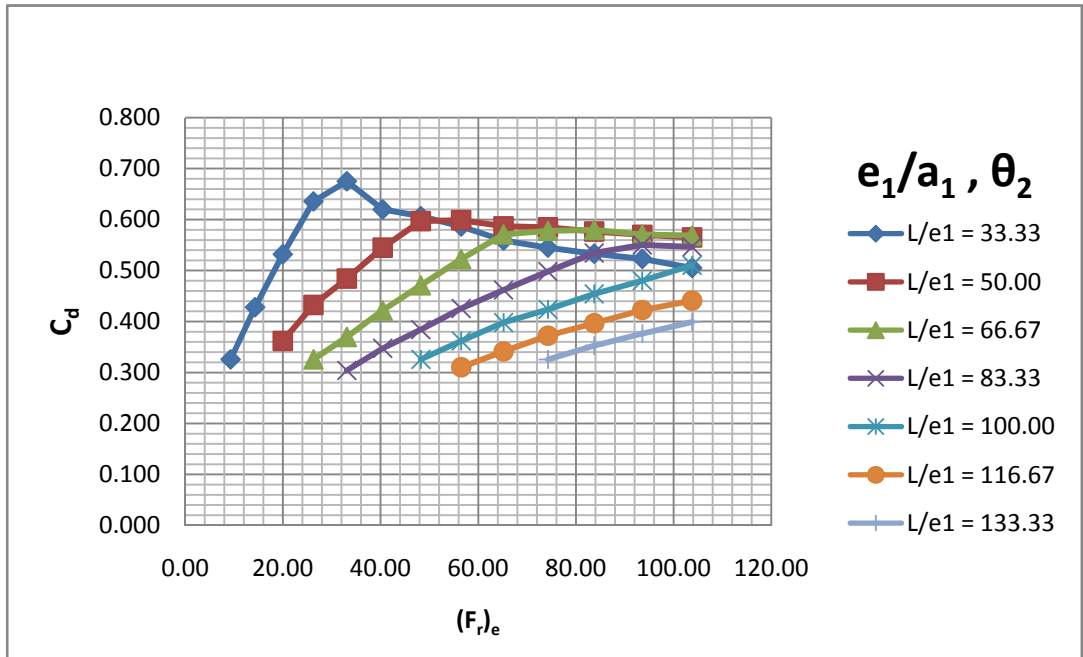

Figure 4.2 Variation of  $C_d$  with  $(F_r)_e$  for the Tyrolean screen of  $e_1/a_1 = 0.23$  and  $\theta_2 = 9.594^\circ$

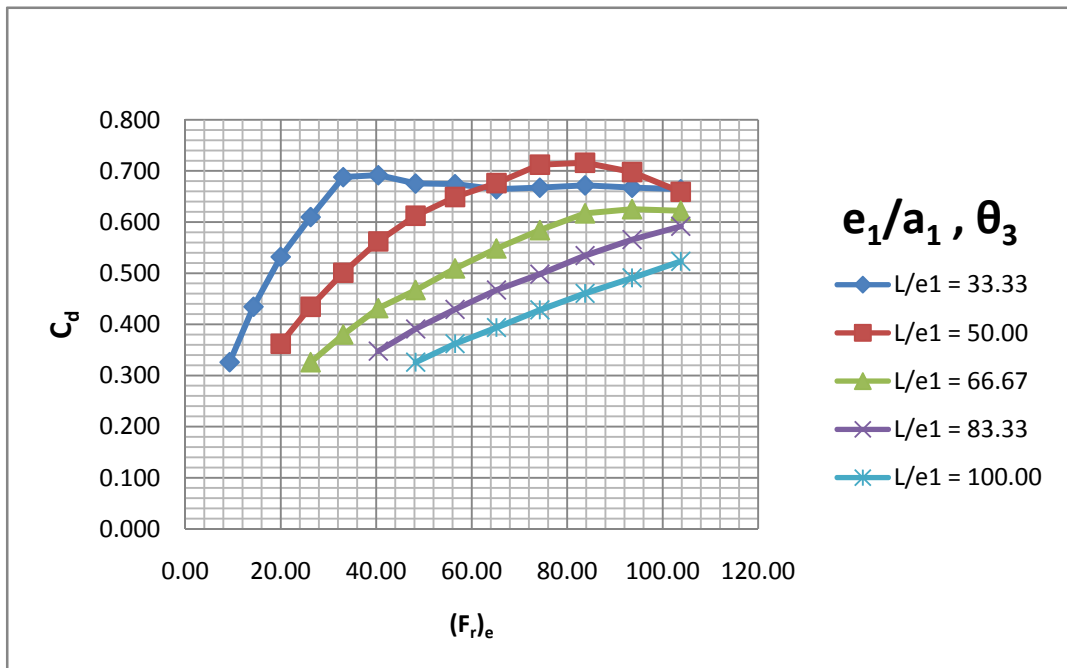

Figure 4.3 Variation of  $C_d$  with  $(F_r)_e$  for the Tyrolean screen of  $e_1/a_1 = 0.23$  and  $\theta_3 = 4.780^\circ$

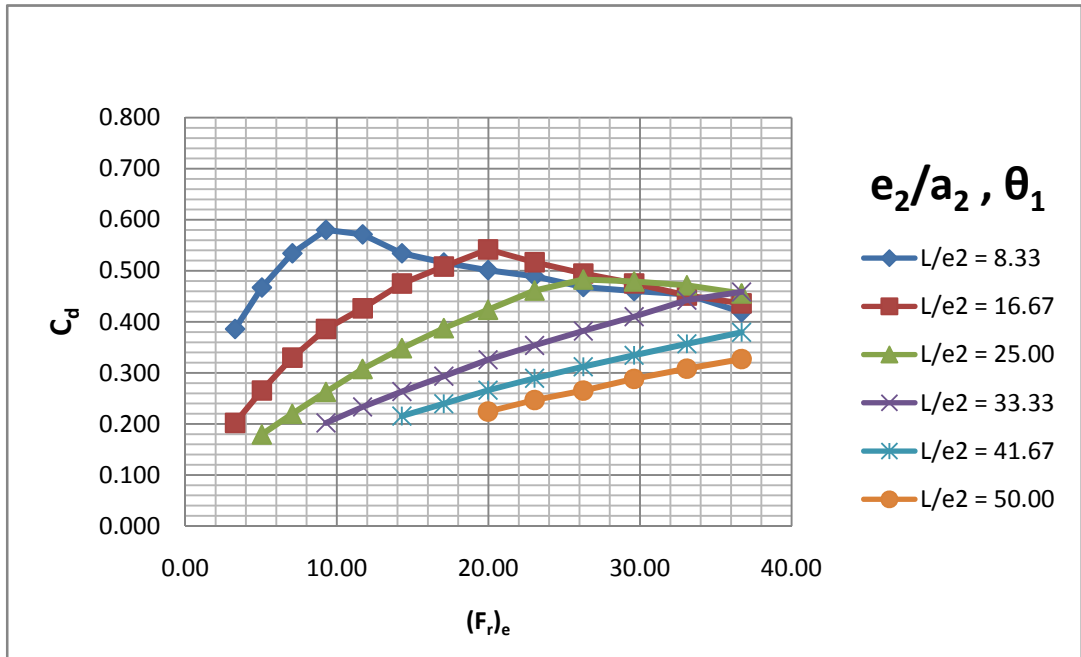

Figure 4.4 Variation of  $C_d$  with  $(F_r)_e$  for the Tyrolean screen of  $e_2/a_2 = 0.375$  and  $\theta_1 = 14.477^\circ$

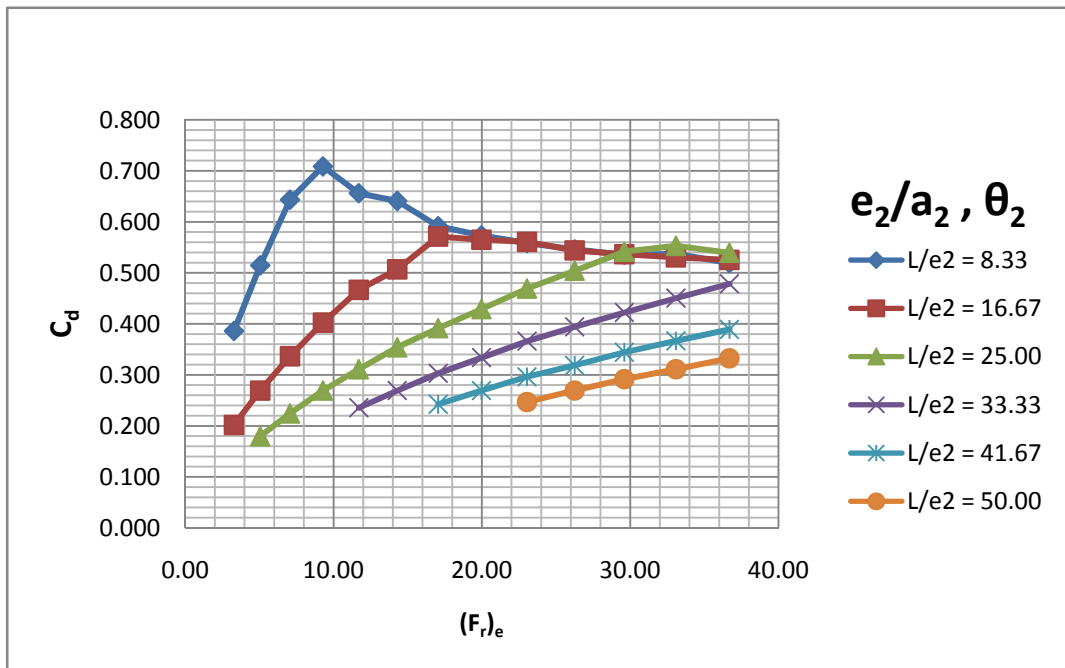

Figure 4.5 Variation of  $C_d$  with  $(F_r)_e$  for the Tyrolean screen of  $e_2/a_2 = 0.375$  and  $\theta_2 = 9.594^\circ$



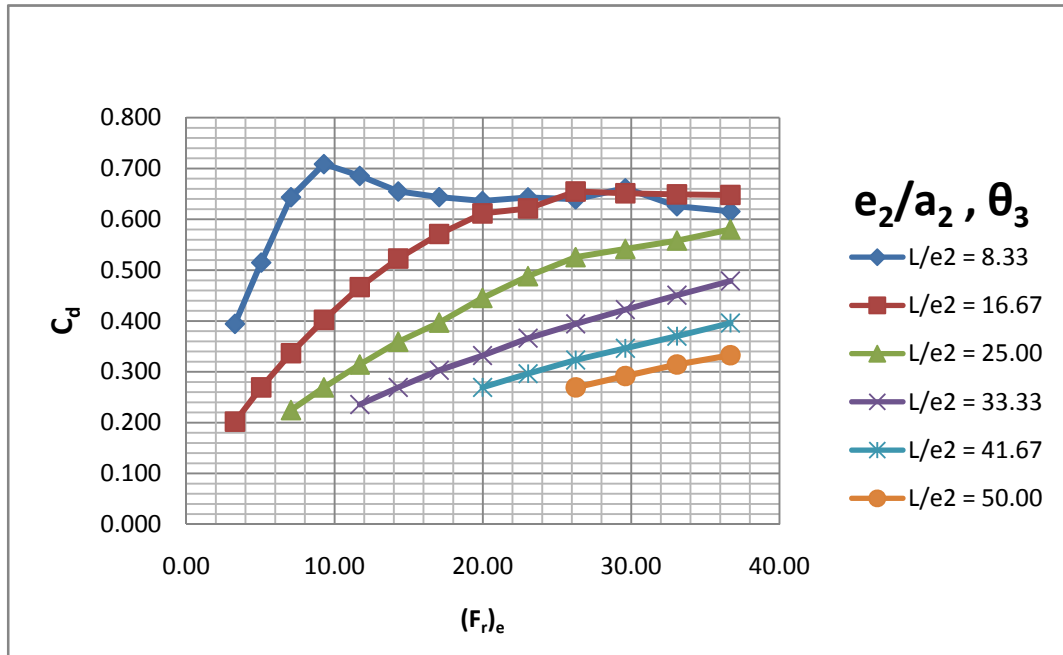

Figure 4.6 Variation of  $C_d$  with  $(Fr)_e$  for the Tyrolean screen of  $e_2/a_2 = 0.375$  and  $\theta_3 = 4.780^\circ$

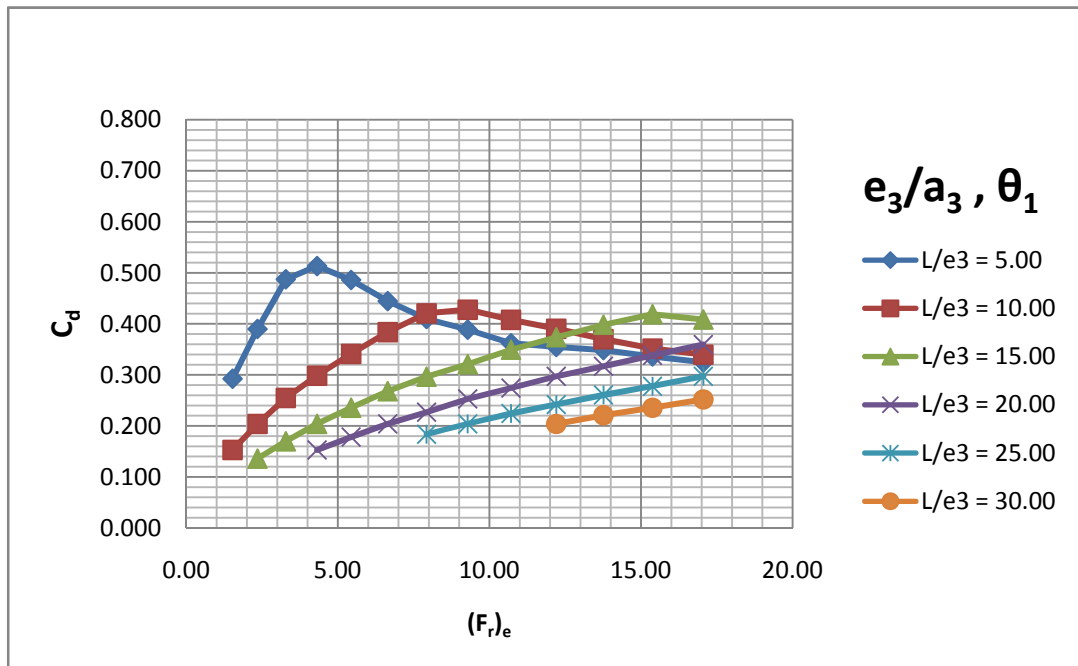

Figure 4.7 Variation of  $C_d$  with  $(Fr)_e$  for the Tyrolean screen of  $e_3/a_3 = 0.5$  and  $\theta_1 = 14.477^\circ$

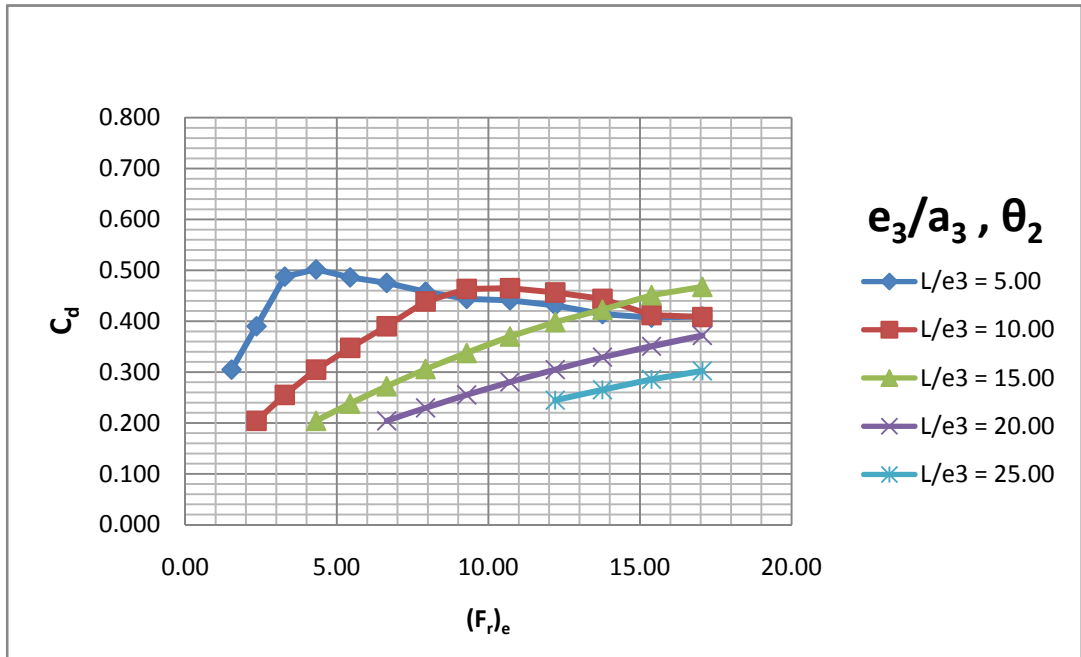

Figure 4.8 Variation of  $C_d$  with  $(Fr)_e$  for the Tyrolean screen of  $e_3/a_3 = 0.5$  and  $\theta_2 = 9.594^\circ$

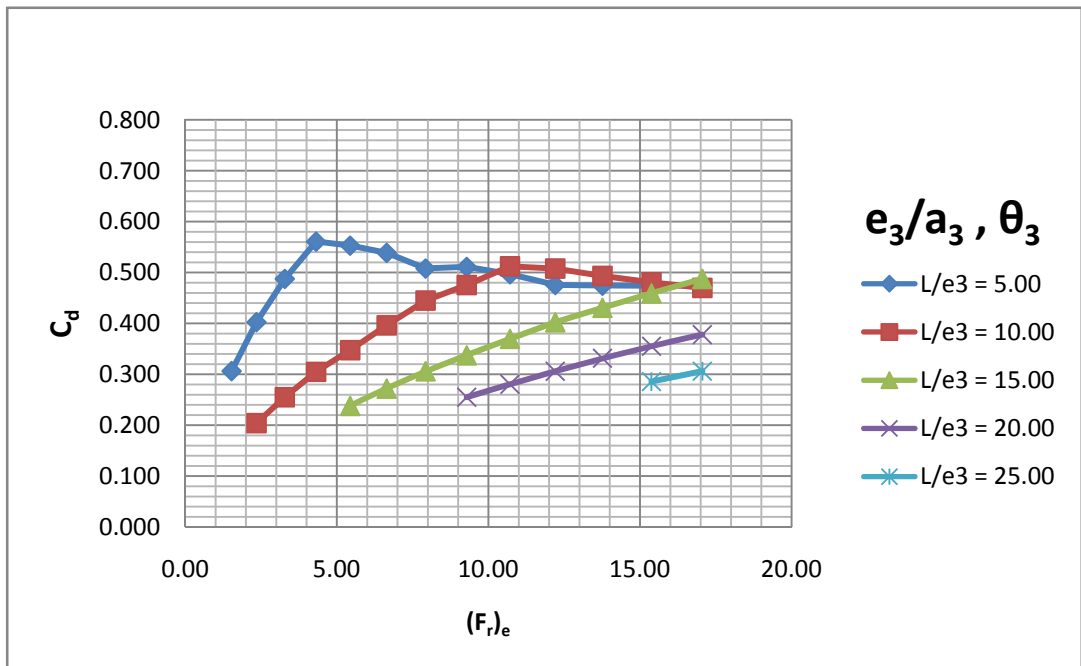

Figure 4.9 Variation of  $C_d$  with  $(Fr)_e$  for the Tyrolean screen of  $e_3/a_3 = 0.5$  and  $\theta_3 = 4.780^\circ$

Referring to Figures 4.1 – 4.9 one can determine the  $C_d$  value for a screen of known parameters;  $e/a$ ,  $\theta$ , and  $(q_w)_T$  and then calculate the flow rate to be diverted from the main channel using Equation 2.5.

#### **4.3 RELATIONSHIP BETWEEN THE WATER CAPTURE EFFICIENCY (WCE) AND THE RELATED DIMENSIONLESS PARAMETERS**

According to Equation 2.8 which expresses a relationship for the water capture efficiency of a Tyrolean screen, Figure 4.10 – 4.18 were plotted for each experimental setup tested. From the assessment of the figures it can be stated that WCE strongly depends on  $L/e$  and  $(F_r)_e$  for a setup of known  $e/a$  and  $\theta$ . For a screen of given  $L/e$  the value of WCE decreases with increasing  $(F_r)_e$ . The dependency of WCE on  $(F_r)_e$  increases as the value of  $L/e$  decreases. At the smallest values of  $L/e$  very small WCE values are obtained as  $(F_r)_e$  increases. As for the effect of rack inclination on the WCE it can be concluded that with increasing  $\theta$ , WCE decreases for a screen of given bar spacing  $L/e$  and  $(F_r)_e$ .

When the bar spacing of the screen is increased, while keeping the screen inclination and bar length constant, from  $e_1$  to  $e_2$  or from  $e_2$  to  $e_3$ , it is seen that  $(F_r)_e$  values are strongly affected and reduced for a given main channel discharge, and this change in the value of  $e$  results in higher WCE values. Referring to Figures 4.10 – 4.18, the WCE of a screen of known properties;  $e/a$ ,  $\theta$ ,  $(F_r)_e$  and  $L/e$ , can be determined as long as these stated parameters are within the values tested in this study.

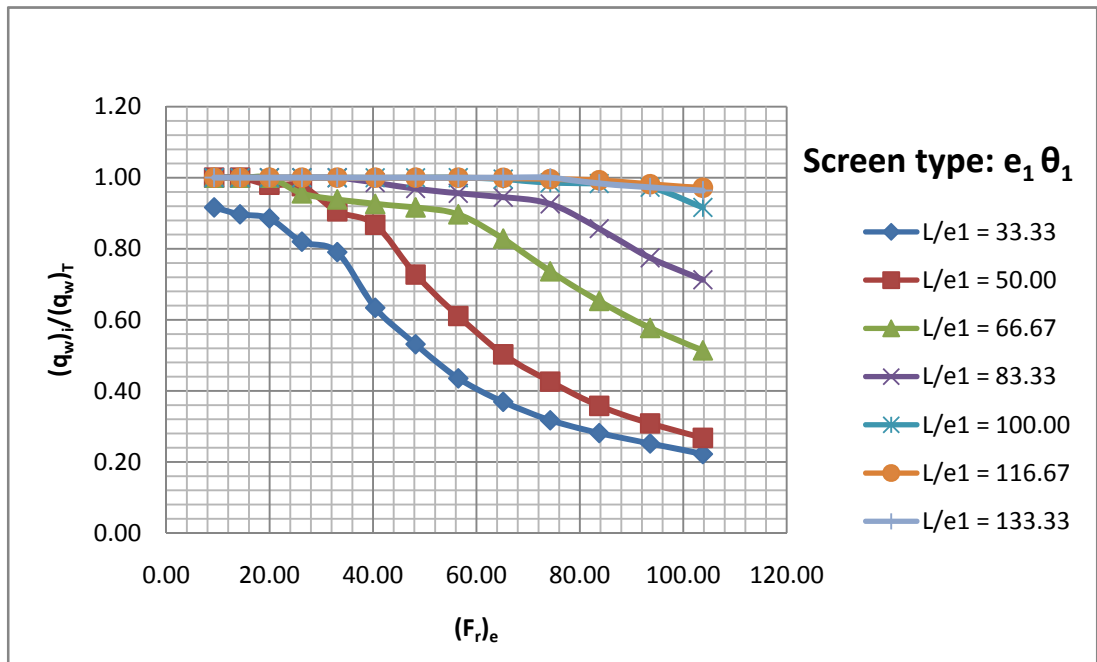

Figure 4.10 Water capture efficiencies for Tyrolean screen of  $e_1/a_1 = 0.23$  and  $\theta_1 = 14.477^\circ$

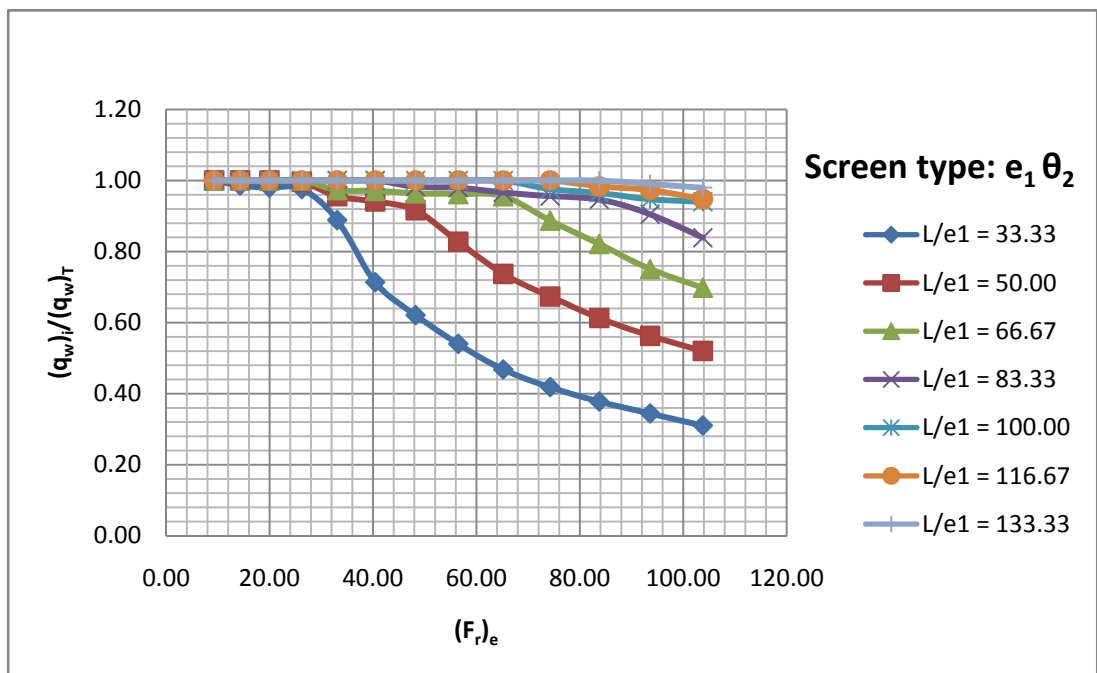

Figure 4.11 Water capture efficiencies for Tyrolean screen of  $e_1/a_1 = 0.23$  and  $\theta_2 = 9.594^\circ$

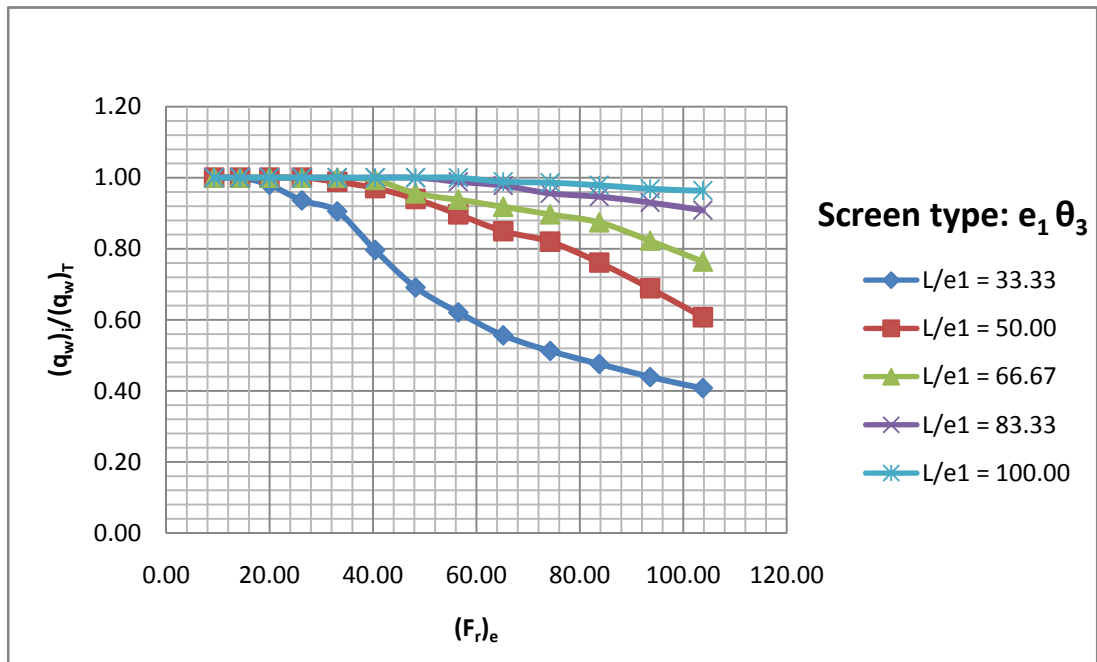

Figure 4.12 Water capture efficiencies for Tyrolean screen of  $e_1/a_1 = 0.23$  and  $\theta_3 = 4.480^\circ$

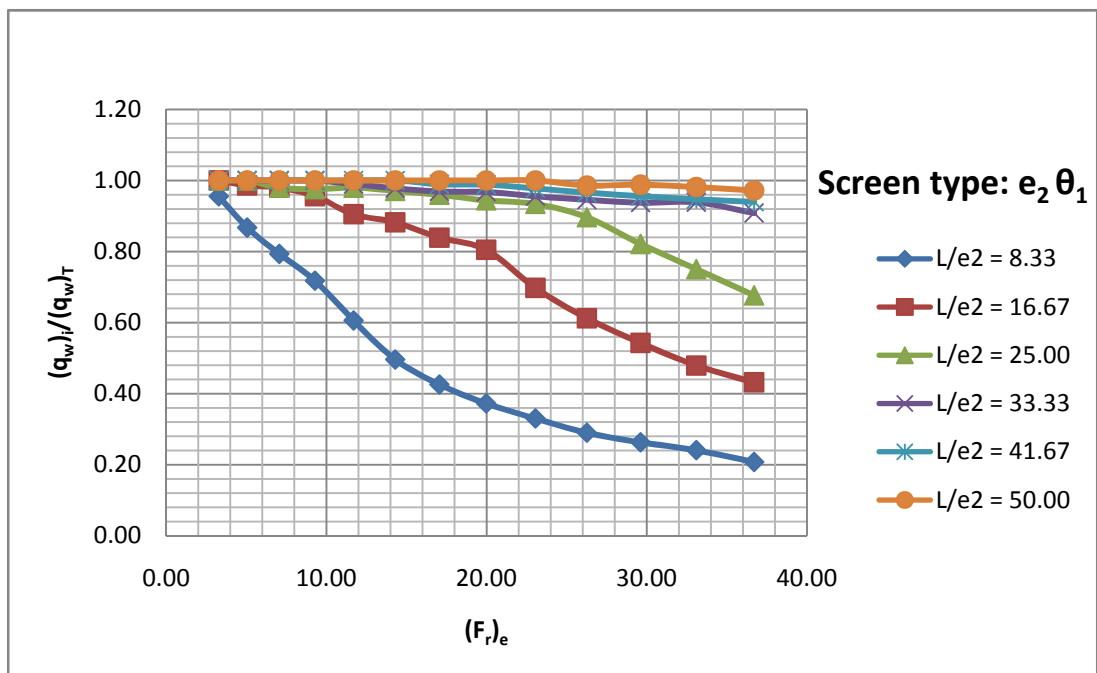

Figure 4.13 Water capture efficiencies for Tyrolean screen of  $e_2/a_2 = 0.375$  and  $\theta_1 = 14.477^\circ$

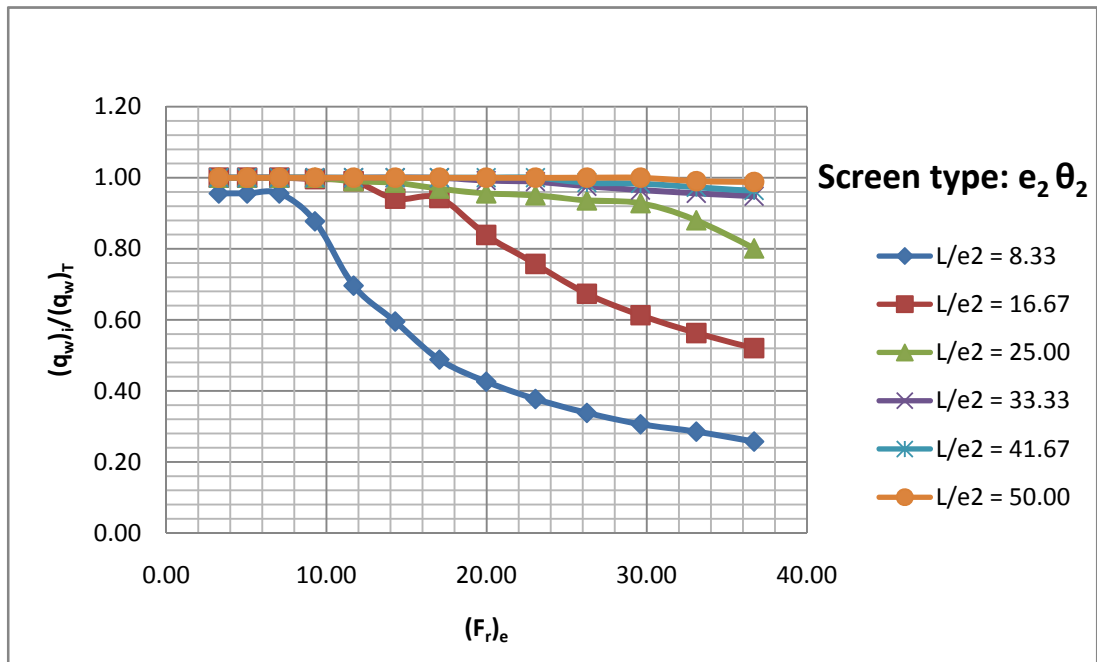

Figure 4.14 Water capture efficiencies for Tyrolean screen of  $e_2/a_2 = 0.375$  and  $\theta_2 = 9.594^\circ$

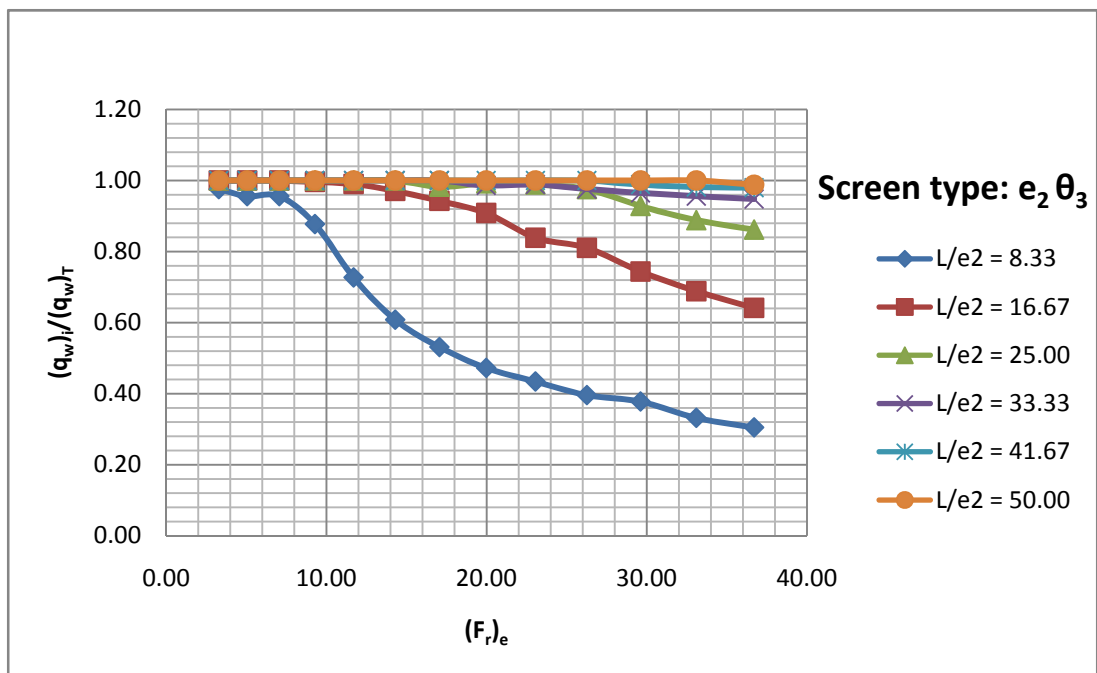

Figure 4.15 Water capture efficiencies for Tyrolean screen of  $e_2/a_2 = 0.375$  and  $\theta_3 = 4.480^\circ$

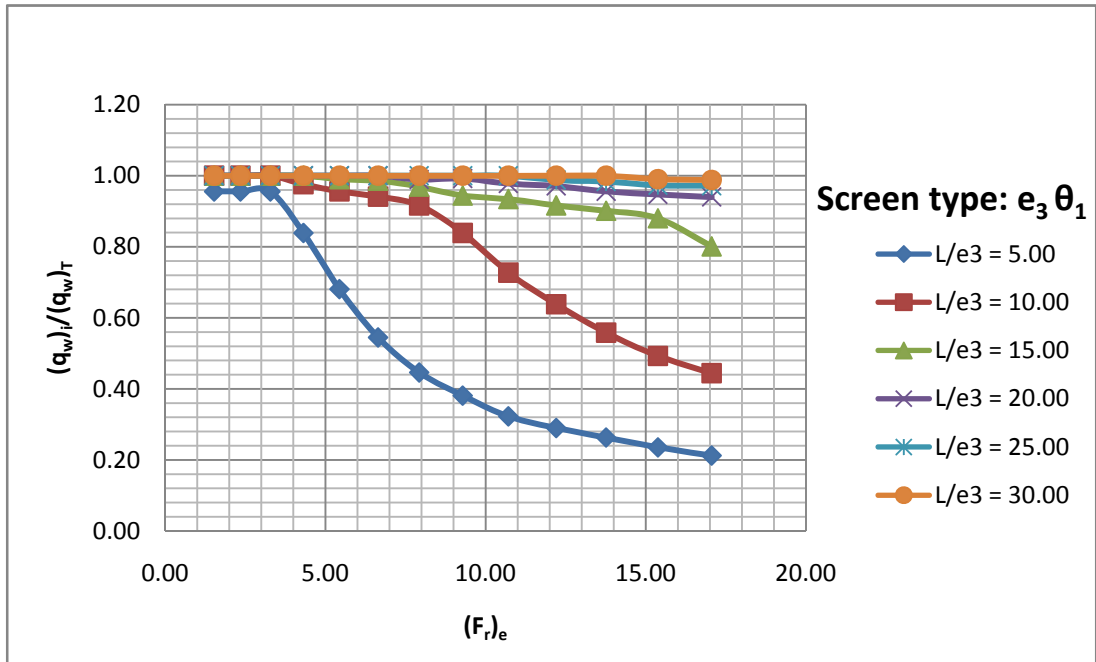

Figure 4.16 Water capture efficiencies for Tyrolean screen of  $e_3/a_3 = 0.5$  and  $\theta_1 = 14.477^\circ$

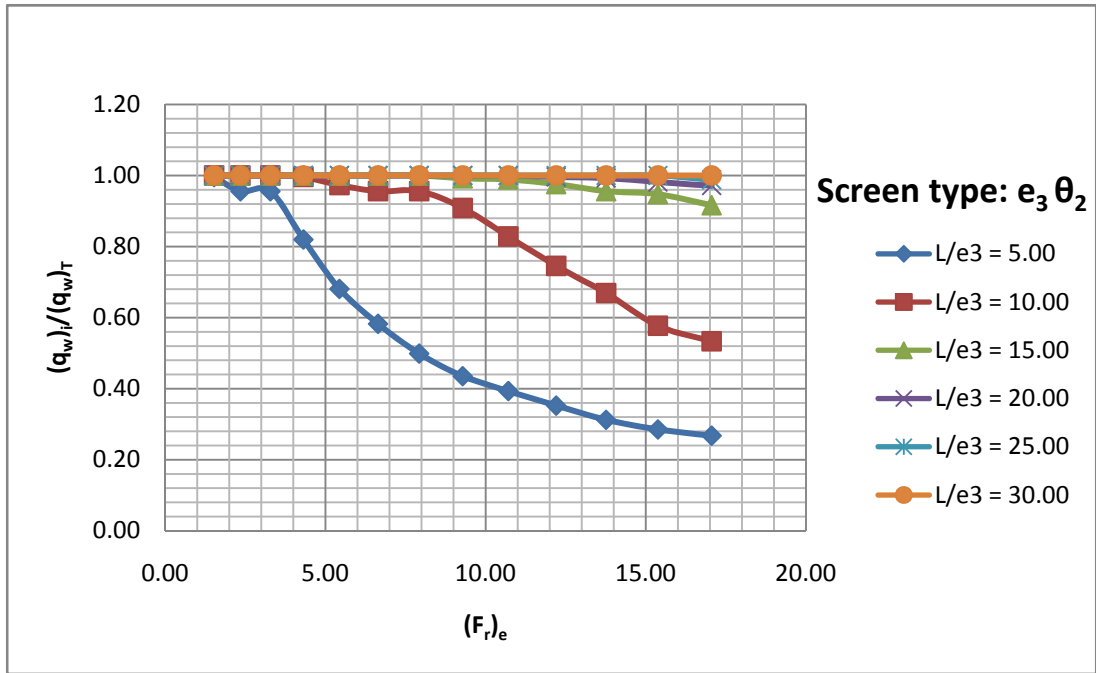

Figure 4.17 Water capture efficiencies for Tyrolean screen of  $e_3/a_3 = 0.5$  and  $\theta_2 = 9.594^\circ$

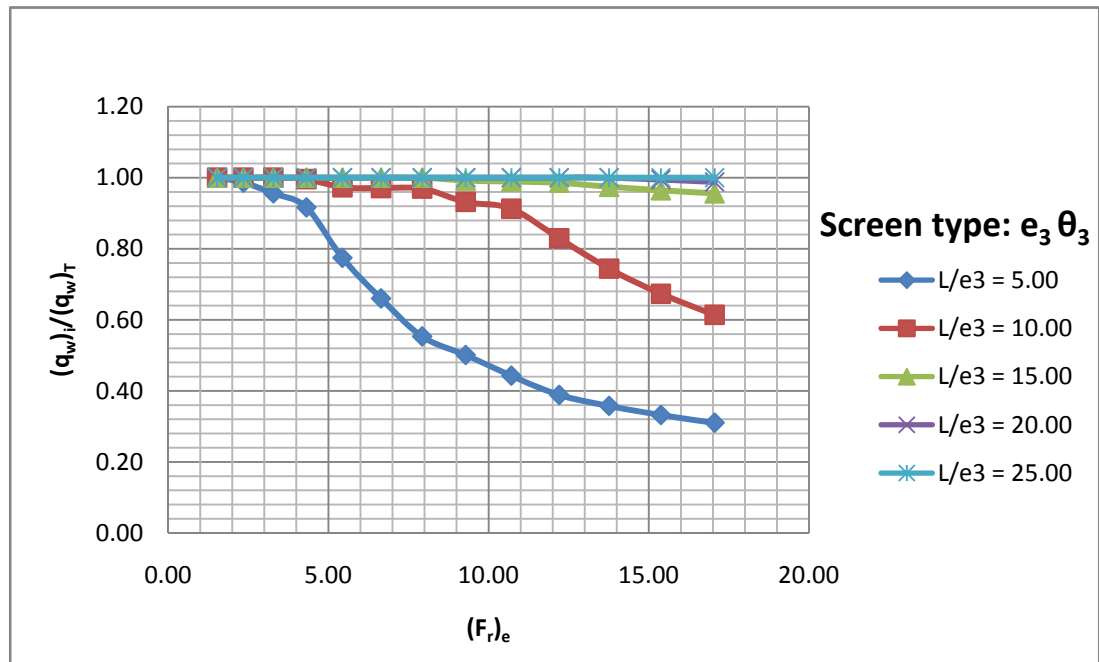

Figure 4.18 Water capture efficiencies for Tyrolean screen of  $e_3/a_3 = 0.5$  and  $\theta_3 = 4.480^\circ$

#### 4.4 SEDIMENT CAPTURE EFFICIENCY AND ITS EFFECT ON THE WATER CAPTURE EFFICIENCY

The results of the experiments conducted with sediment were presented in Figures 4.19 – 4.21 in the form of sediment capture efficiencies as function of angle of rack inclination and rack lengths for bar openings of  $e_1 = 3$  mm,  $e_2 = 6$  mm and  $e_3 = 10$  mm, respectively. From these figures it can be stated that for a screen of known bar opening,  $e$ , the sediment capture efficiency of the screen gradually increases with decreasing angle of rack inclination,  $\theta$ , for a given rack length, and decreases with increasing rack length,  $L$ , for a given angle of rack inclination.

The observed minimum and maximum sediment capture efficiencies for the screens of  $e = 3$  mm, 6 mm and 10 mm are 24.00 and 43.00 %, 42.25 and 52.75 % and 64.75 and 79.00 %, respectively for  $\theta$  and  $L$  values tested. If the same figures are analyzed for the effect of bar spacing on the values of



sediment capture efficiency of the screen having fixed  $L$  and  $\theta$  values it is seen that as the bar opening is increased, the sediment capture efficiency increases significantly.

In order to see the effect of clogging of the bar openings with sediment on the water capture efficiency of the screen, the related data given in Appendix B were plotted in Figures 4.22 - 4.24, for screens of  $e = 3$  mm, 6 mm and 10 mm, respectively. These figures reveal that water capture efficiencies almost do not change with  $\theta$  for a given screen length, even if the bar spacing of the screen increases. However, the increment of the water capture efficiency with rack length for a given  $\theta$  is almost linear. This is very logical because, as the length of the rack increases, the possibility of clogging the rack bar openings reduces. The most severe reduction in the water capture efficiency is observed in the screens of  $e_1 = 3$  mm even when the rack length tested was maximum  $L_c = 60$  cm. It means that the small bar openings can easily be clogged by sediment and about 80 % water capture efficiency is obtained from the longest screen instead of the expected value of 100 %. To show the rate of clogging of the rack bar opening, Figure 4.25 – 4.30 were plotted using some data of some of the screens tested. From these figures it is clearly seen that as time passes, the water capture efficiency of the screen drops to the minimum values observed at the end of the time periods of the experiments as a function of the screen type used.

During flood times the main channel carries lots of bed load and since they will all pass over the weir rack, clogging of the rack bar openings will occur. This phenomenon results in a reduction in the amount of flow to be diverted from the main channel. Therefore, as a final conclusion it can be stated that in practice, the lengths of the rack bars should be kept about 20 – 30 % nger than the values to be calculated to be in the safe side.

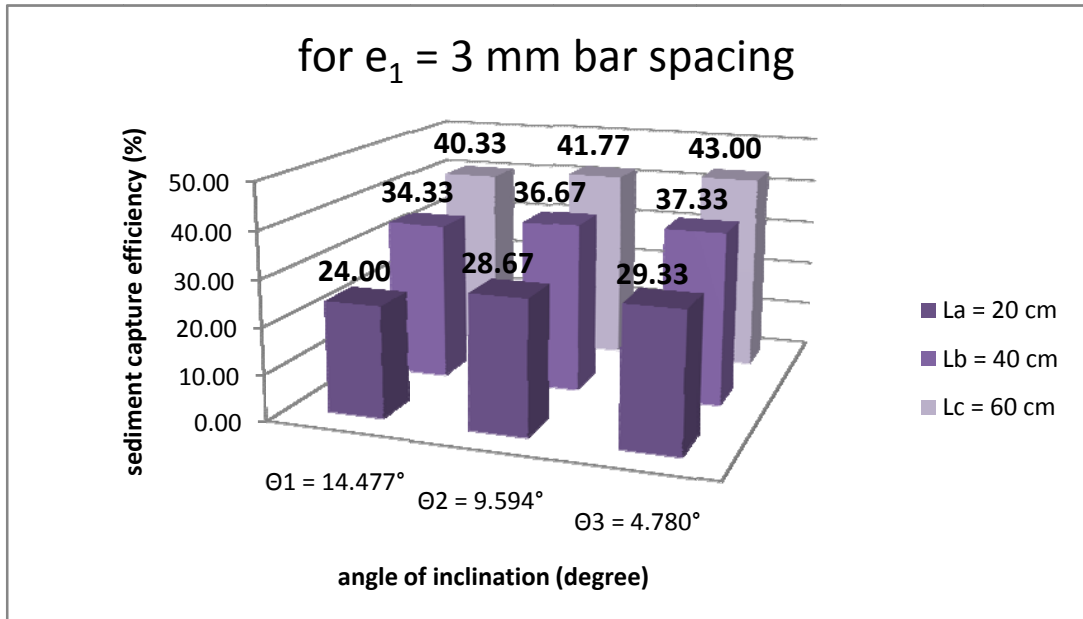

Figure 4.19 Sediment capture efficiencies for  $e_1 = 3$  mm

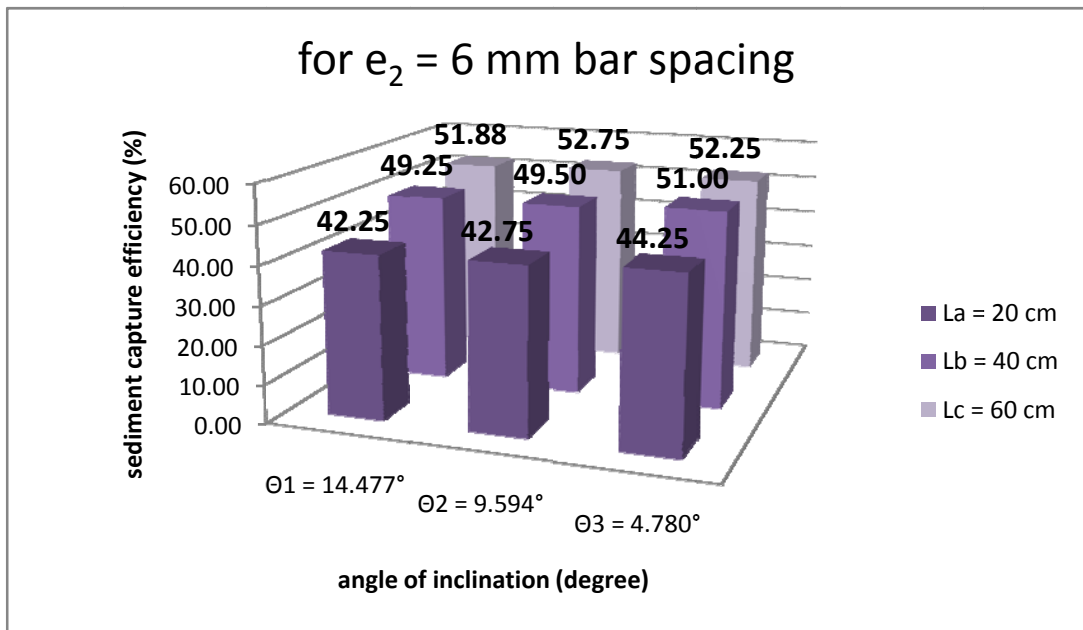

Figure 4.20 Sediment capture efficiencies for  $e_2 = 6$  mm

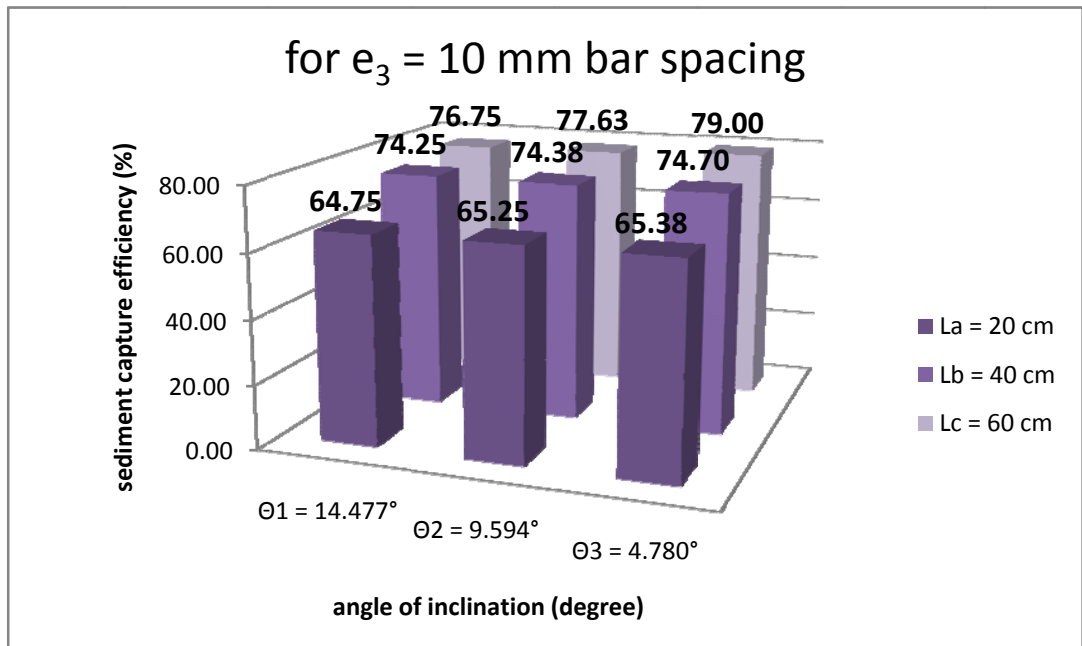

Figure 4.21 Sediment capture efficiencies for  $e_3 = 10$  mm

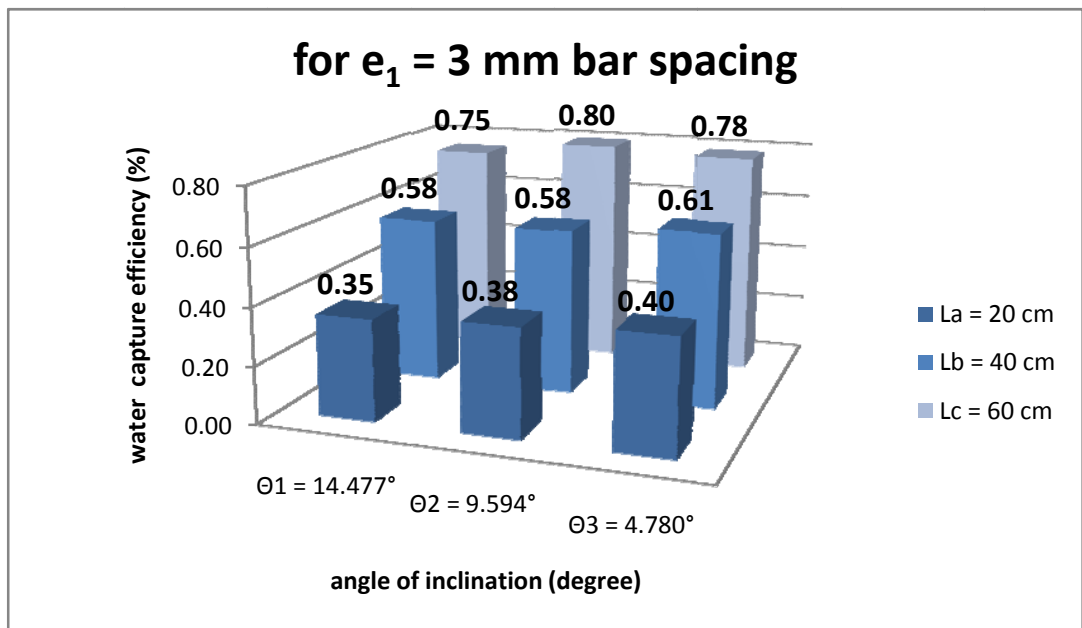

Figure 4.22 Water capture efficiencies for  $e_1 = 3$  mm

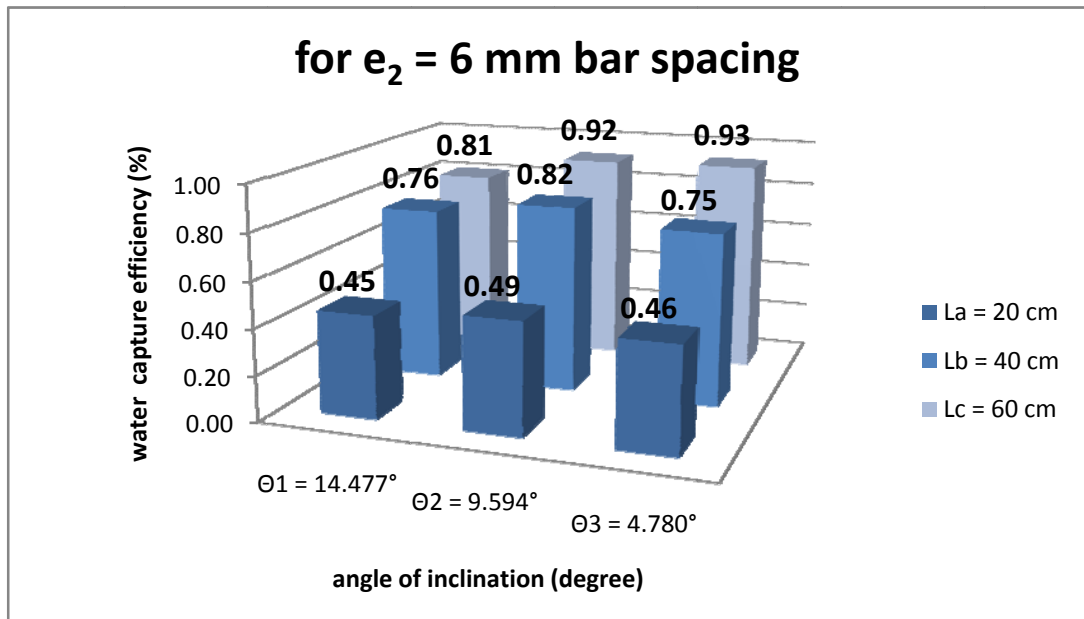

Figure 4.23 Water capture efficiencies for  $e_2 = 6$  mm

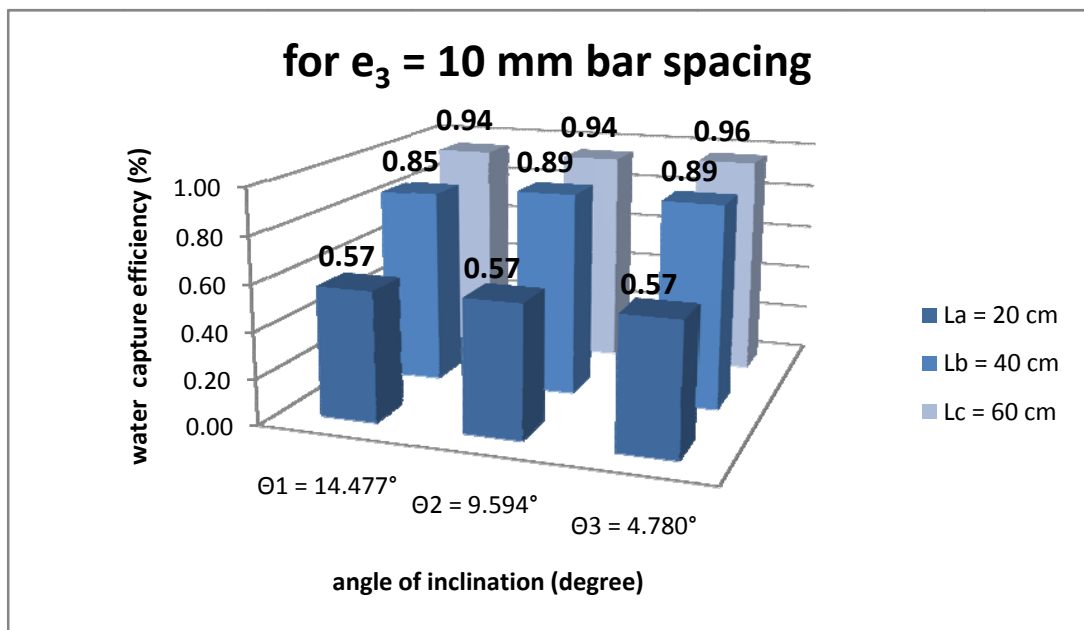

Figure 4.24 Water capture efficiencies for  $e_3 = 10$  mm

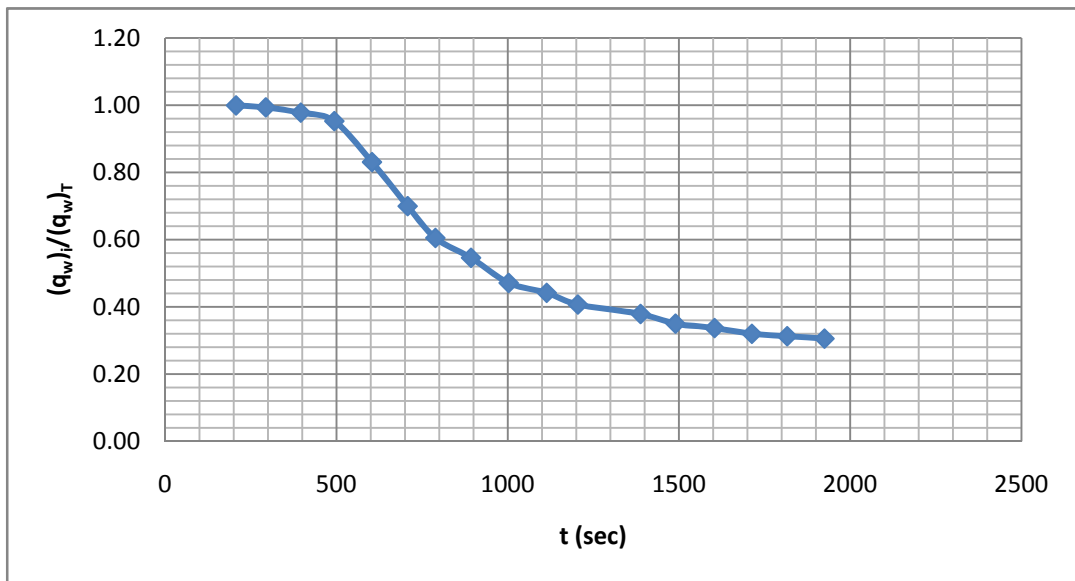

Figure 4.25 Variation of  $(q_w)_i / (q_w)_T$  with time ( $e_1/a_1 = 0.23$ ,  $L_a = 20$  cm  $\theta_1 = 14.477^\circ$ )

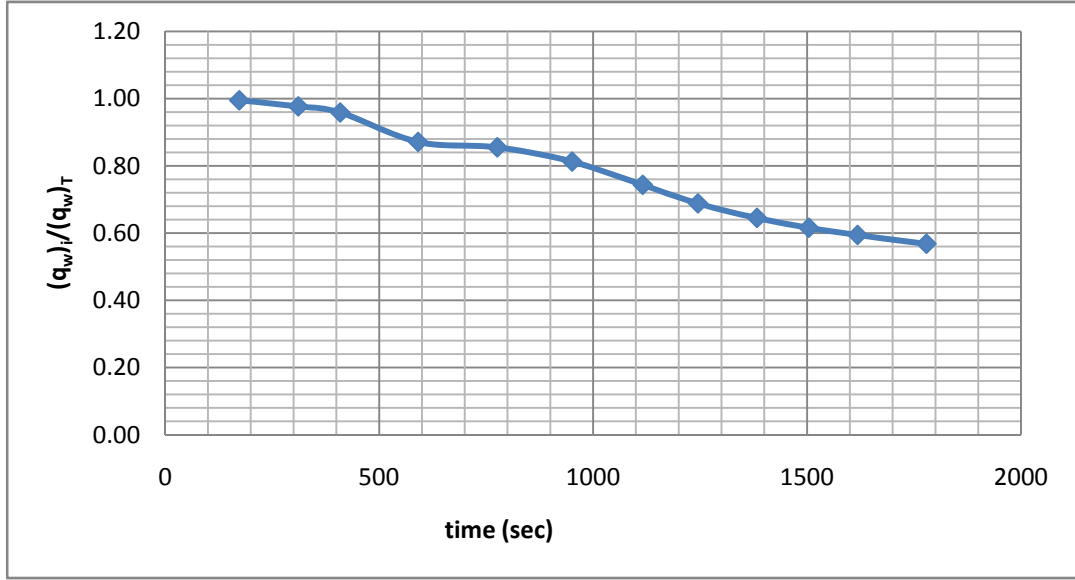

Figure 4.26 Variation of  $(q_w)_i / (q_w)_T$  with time ( $e_1/a_1 = 0.23$ ,  $L_b = 40$  cm  $\theta_3 = 4.480^\circ$ )

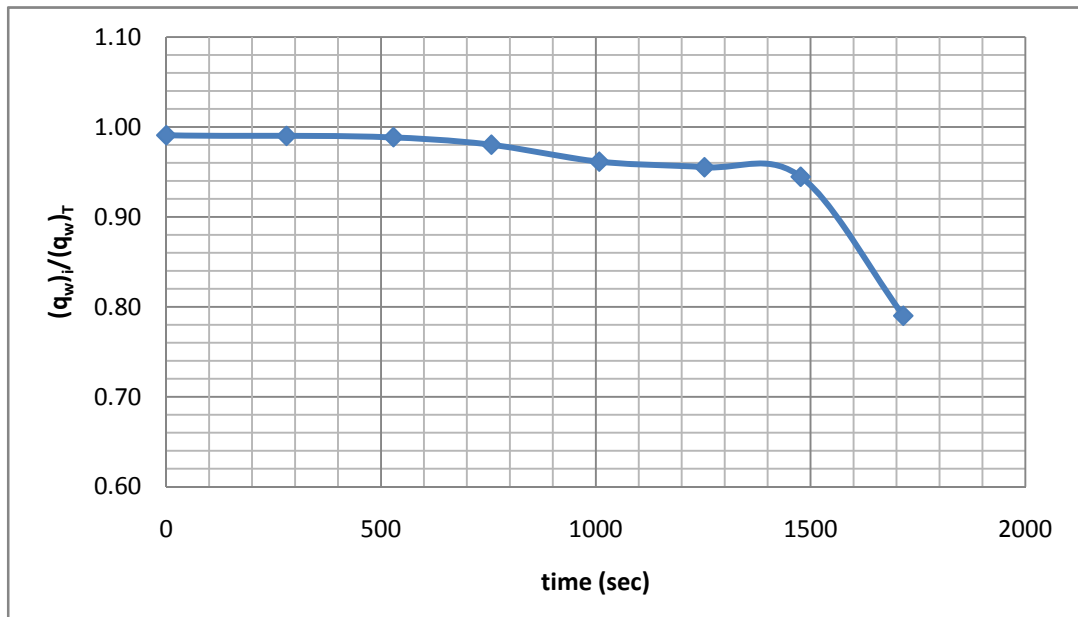

Figure 4.27 Variation of  $(q_w)_i / (q_w)_T$  with time ( $e_2/a_2 = 0.375$ ,  $L_c = 60$  cm  $\theta_1 = 14.477^\circ$ )

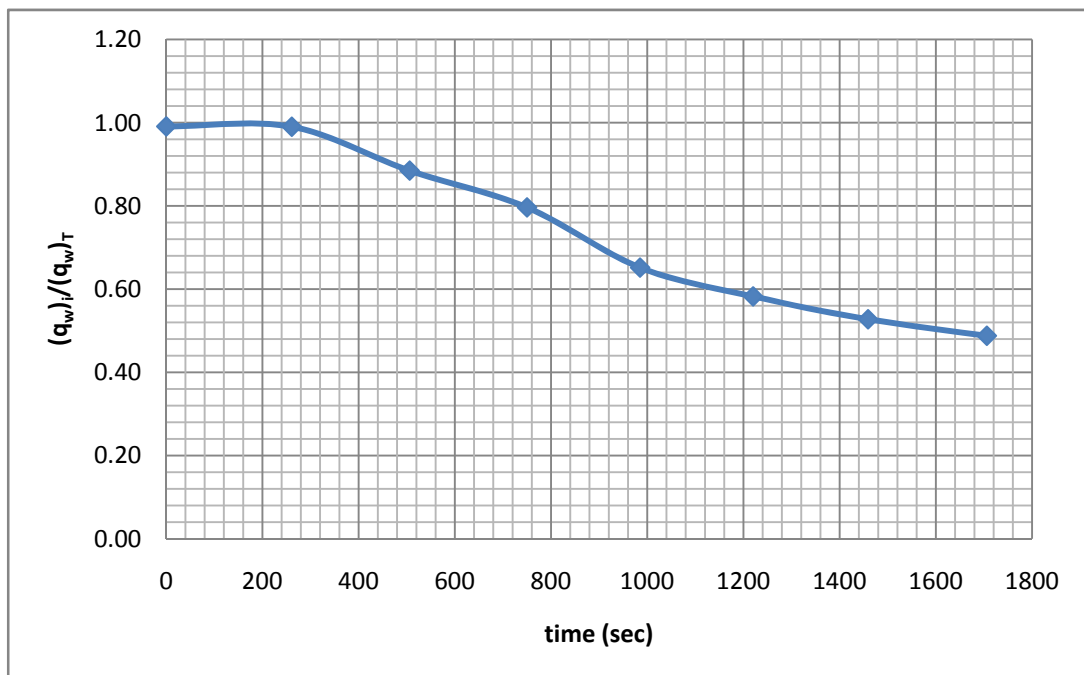

Figure 4.28 Variation of  $(q_w)_i / (q_w)_T$  with time ( $e_2/a_2 = 0.375$ ,  $L_a = 20$  cm  $\theta_2 = 9.594^\circ$ )

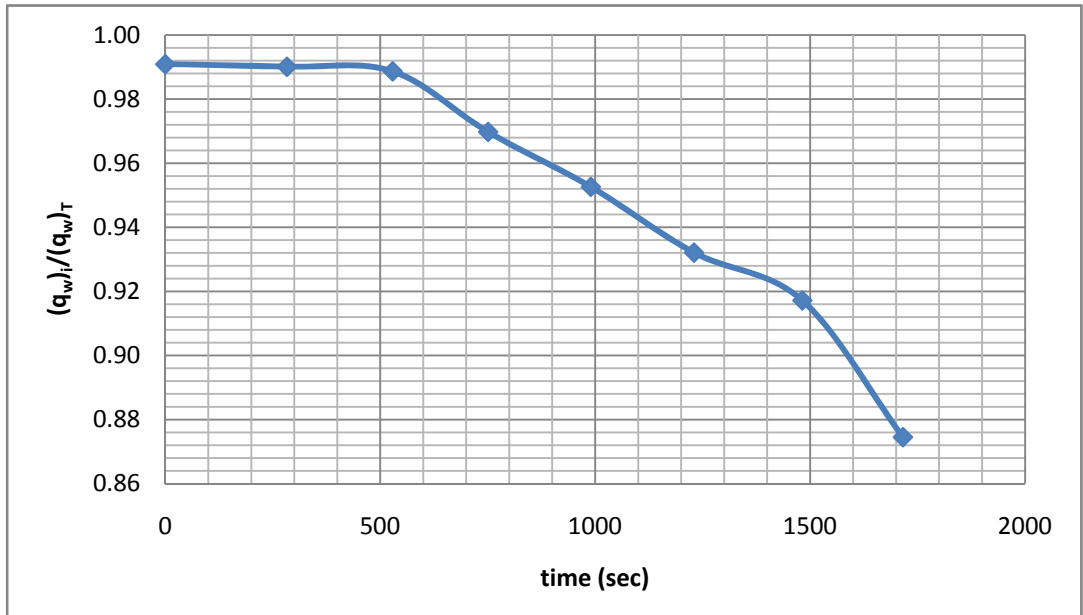

Figure 4.29 Variation of  $(q_w)_i / (q_w)_T$  with time ( $e_3/a_3 = 0.5$ ,  $L_b = 40$  cm  $\theta_2 = 9.594^\circ$ )

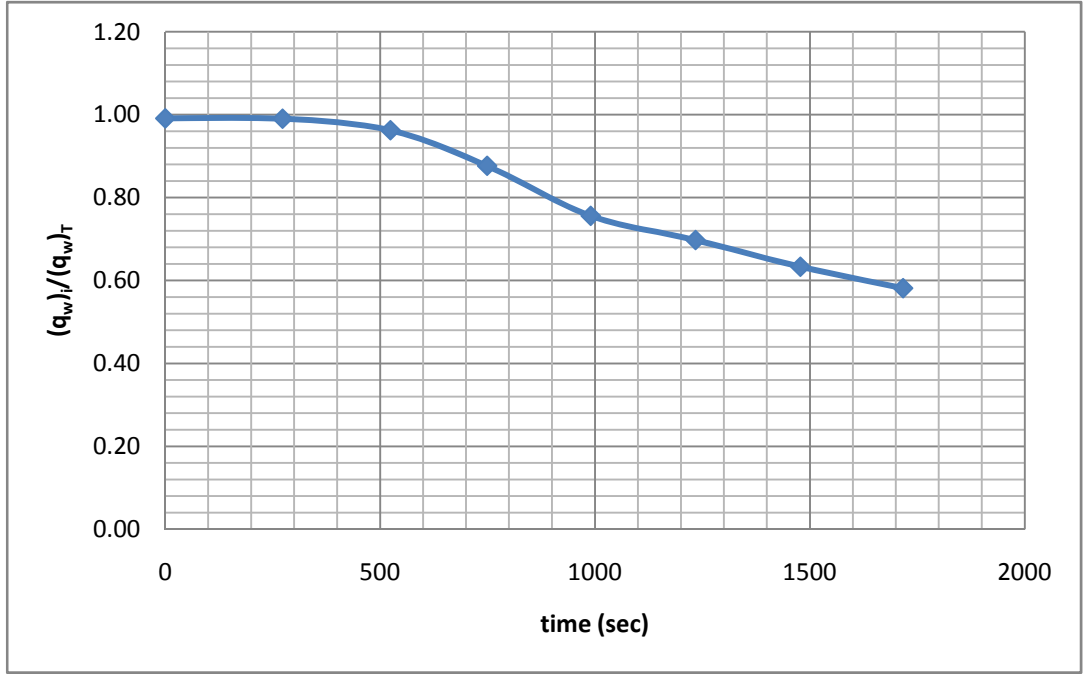

Figure 4.30 Variation of  $(q_w)_i / (q_w)_T$  with time ( $e_3/a_3 = 0.5$ ,  $L_a = 20$  cm  $\theta_3 = 4.480^\circ$ )

#### **4.5 VARIATION OF THE DIMENSIONLESS WETTED RACK LENGTH, $L_2/e$ , WITH $(F_r)_e$ AND $\theta$**

The wetted rack length of a Tyrolean weir can be defined as the minimum rack length required to divert the desired flow discharge from the main channel,  $L_2$ , shown in Figure 1.3. The measured data of  $L_2$  for the screens tested in this study were presented in Figures 4.31 – 4.33 in the form of  $L_2/e$  as a function of  $(F_r)_e$  and  $\theta$ . The general trend of the data given in these figures shows that  $L_2/e$  almost linearly increase with increasing  $(F_r)_e$  for a given value of  $\theta$ . For a given value of  $(F_r)_e$ ,  $L_2/e$  increases with increasing  $\theta$ . The values of  $L_2$  for a screen of known  $e$  and  $\theta$  can be determined from the related figure.

The theoretical minimum length of a screen to be used in practice to divert a flow at required amount should be equal to  $L_2$ . However, as stated in the earlier section, due to the clogging problem of the bar openings, the screen length to be used should be selected at least 20 – 30 % larger than  $L_2$ .

In order to form a design chart for  $L_2$  which will cover different values of  $e/a$ , additional experiments should be conducted with screens having bars of different diameters covering a larger range and with bars of different shapes.



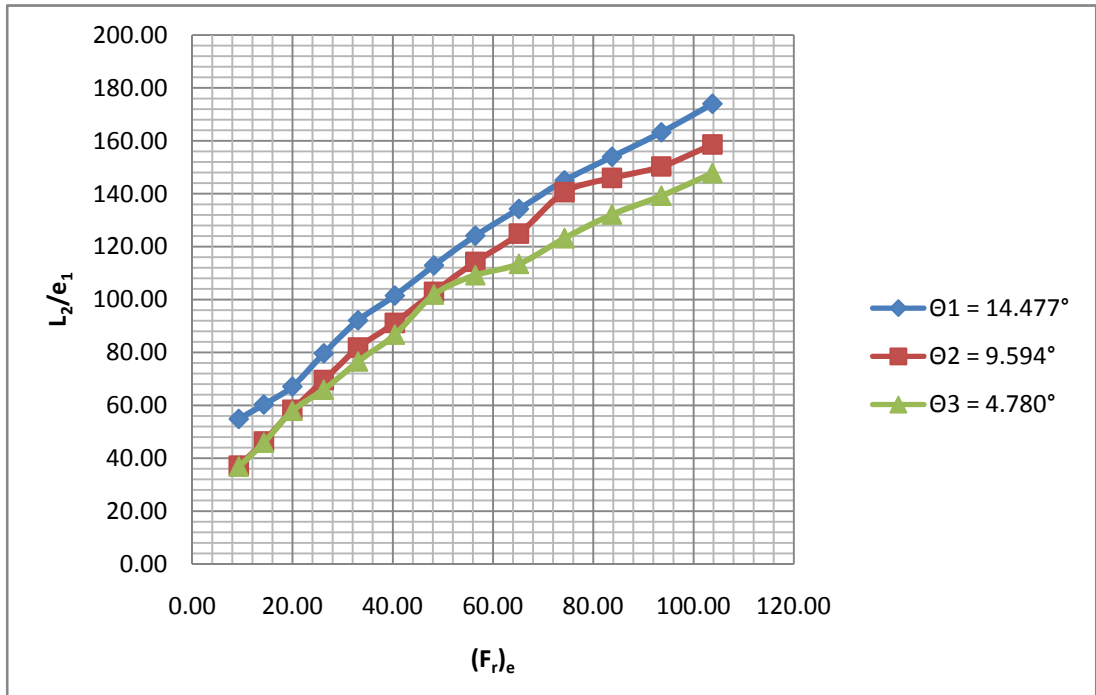

Figure 4.31 Variation of  $L_2/e_1$  with  $(F_r)_e$  and  $\theta$  for screens of  $e_1/a_1 = 0.23$

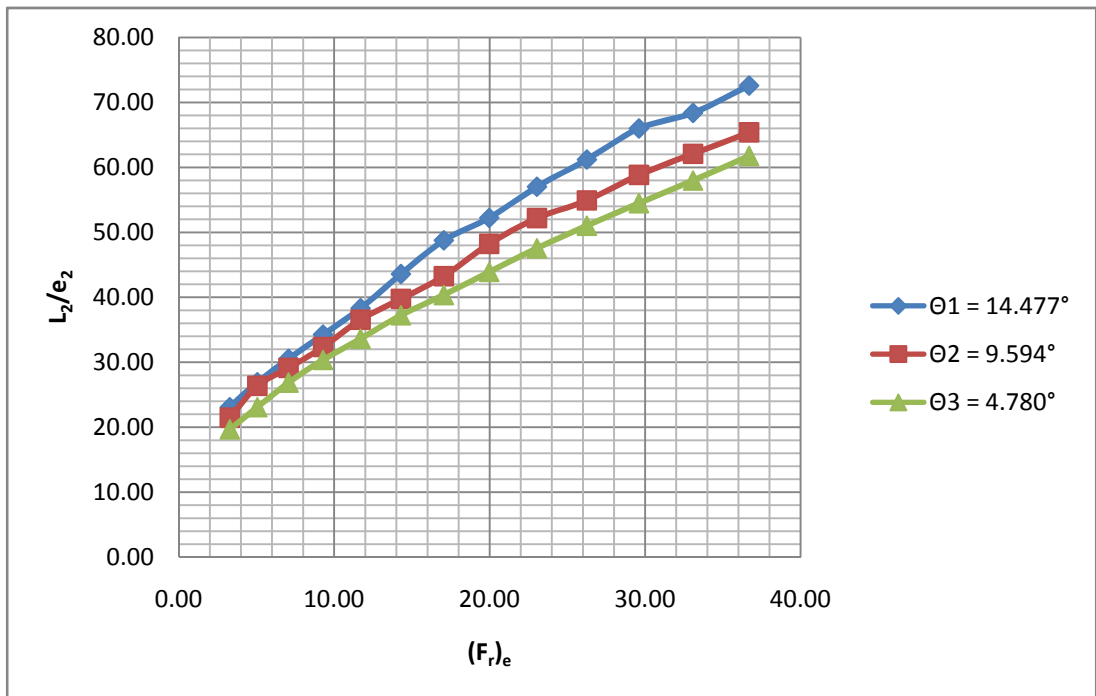

Figure 4.32 Variation of  $L_2/e_1$  with  $(F_r)_e$  and  $\theta$  for screens of  $e_2/a_2 = 0.375$

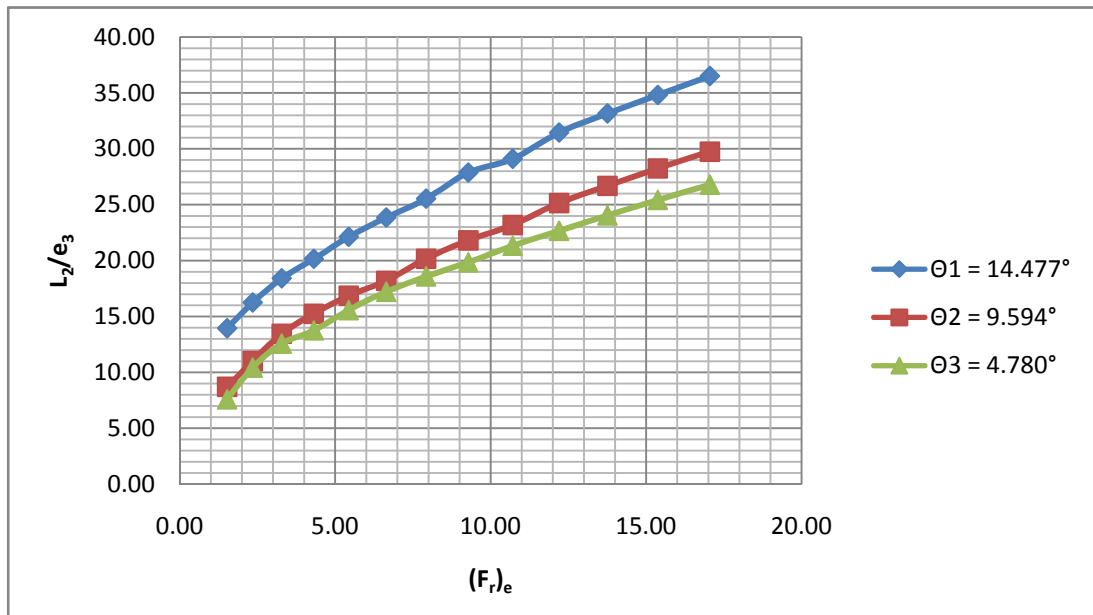

Figure 4.33 Variation of  $L_2/e_1$  with  $(Fr)_e$  and  $\theta$  for screens of  $e_3/a_3 = 0.5$

#### 4.6 COMPARISON OF $C_d$ VALUES OF THIS STUDY WITH THOSE OBTAINED FROM SUBBRANAMANYA'S EQUATION

Subranamanya's equation (1994) for  $C_d$ , Eq. (1.4), which is valid for rocks of rounded bars is function of  $D/e$  and  $\tan\theta$ , there is no any term related to the upstream flow conditions, whereas it has been shown in this study that  $C_d$  values is also function of upstream flow discharge in the form of  $(Fr)_e$ . For the screen types tested if the values of  $C_d$  given by Eq. (1.4) are calculated and they are listed in Table 4.1 along with those corresponding to the same screen types of  $L \approx L_2$  from Appendix A it is clearly seen that the  $C_d$  values are absolutely different.

Table 4.1 Comparison of  $C_d$  values given by Equation (1.4) and Equation (2.5)

Screen Type	$C_d$ (Eq. 2.5)	$C_d$ (Eq. 1.4)
$e_1\theta_1L_2$	0.271-0.397	0.580
$e_1\theta_2L_2$	0.326-0.398	0.636
$e_1\theta_3L_2$	0.362-0.404	0.688
$e_2\theta_1L_2$	0.580-0.247	0.461
$e_2\theta_2L_2$	0.269-0.402	0.516
$e_2\theta_3L_2$	0.292-0.402	0.568
$e_3\theta_1L_2$	0.204-0.359	0.323
$e_3\theta_2L_2$	0.286-0.306	0.427
$e_3\theta_3L_2$	0.305-0.332	0.479

## CHAPTER 5

### CONCLUSIONS AND FURTHER RECOMMENDATIONS

In this study, the effect of the rack inclination angle, the rack bar spacing and the rack length on the water and sediment capture efficiencies of Tyrolean weir were investigated. An expression for the discharge coefficient of a Tyrolean weir was derived and its variation with related dimensionless parameters were presented.

From the analysis of the experimental results the following conclusions can be drawn:

- 1)** For diverted flow discharge from the main channel per unit width an equation was derived in terms of the discharge coefficient of the Tyrolean weir, net bar opening area per unit width and the critical energy head of the flow in the main channel (Equation 2.5). If the flow discharge of the main channel and screen properties are known, by selecting the proper discharge coefficient from related diagrams, one can determine the diverted flow discharge.
- 2)** Water capture efficiency and wetted rack length of Tyrolean weirs were expressed as a function of dimensionless parameters  $(F_r)_e$ ,  $L/e$ ,  $e/a$  and  $\theta$  using the dimension analysis.
- 3)** The discharge coefficient  $C_d$ , in general, increases with increasing  $(F_r)_e$  for a screen of given  $e$ ,  $\theta$  and variable length  $L$ . When the weir has very short lengths that is small  $L/e$  values,  $C_d$  value first increases rapidly as  $(F_r)_e$  increase, and then gradually decreases or continues horizontally as a function of the bar inclination angle of  $\theta$ .

- 4) If the angle of inclination of a selected screen increases while keeping  $(F_r)_e$  and  $L/e$  constant,  $C_d$  values slightly decrease.
- 5) If the bar spacing of a screen of constant  $\theta$  increases while keeping  $(F_r)_e$  and  $L/e$  constant,  $C_d$  values decrease.
- 6) The water capture efficiency, WCE, of a Tyrolean screen strongly depends on  $L/e$  and  $(F_r)_e$  for a screen of known  $e/a$  and  $\theta$ . For a given  $L/e$  the value of WCE decreases with increasing  $(F_r)_e$ .
- 7) With increasing  $\theta$ , WCE decreases for a screen of given bar spacing,  $L/e$  and  $(F_r)_e$ .
- 8) When the bar spacing of the screen increased while keeping the screen inclination and bar length constant,  $(F_r)_e$  values are strongly affected for a given main channel discharge and reduce, and this change in the value of  $e$  results in higher WCE values.
- 9) Bed load carried by the main channel very seriously affects the performance of Tyrolean screens. Clogging of the rack bar spacings occur and this results in reduction in the water capture efficiencies of the screens. Therefore in practice the rack bar lengths to be calculated should be multiplied by a safety factor of about 1.2-1.3.
- 10) The dimensionless wetted rack lengths,  $L_2/e$ , are functions of  $(F_r)_e$  and  $\theta$ . For a given  $(F_r)_e$ ,  $L_2/e$  values increase with increasing  $\theta$ .

Recommendations for future studies are as follows;

Experiments similar to those conducted in this study should be repeated using rack bars of different diameters and shapes with steeper bar inclination angles. After that general charts to be used in practical applications can be formed.

## REFERENCES

- Ahmad, Z., Mittal M.K., (2006). Recent advances in the design of trench weir, Himalayan small hydropower summit, Dehradun, India. pp. 72-84
- Andaroodi M. (2005), Standardization of civil engineering works of small hydropower plants, École Polytechnique Federale de Lausanne, Switzerland.
- Brunella, S., Hager, W.H., Minor, H.E., (2003). Hydraulics of Bottom Intake. J. Of Hydraulic Engineering, ASCE 0733-9429
- Drobir, H., Kienberger, V., Krouzecky, N., (1999). The Wetted Rack Length of the Tyrolean Weir. Proceedings XXVIII IAHR Congress, IAHR
- Hager W.H., Minor H.-E. Hydraulic design of bottom rack intakes. 30 IAHR Congress Thessaloniki D: 495-502
- Huber, D., (2005). BEDUIN Project. The Higher Institute for Hydraulic and Mechanical Engineering of Grenoble, France
- Kamanbedast, A. A., Bejestan, M. S. (2008). Effects of Slope and Area Opening on the Discharge Ratio in Bottom Intake Structures. Journal of Applies Sciences, ISSN 1812-5654
- Righetti, M., Lanzoni, S., (2008). Experimental Study of the Flow Field over Bottom Intake Racks. J. Of Hydraulic Engineering, ASCE 0733-9429

## **APPENDIX A**

### **MEASURED AND CALCULATED PARAMETERS FOR THE EXPERIMENTS CONDUCTED WITH THE TRASH RACK OF DIFFERENT $e$ AND $\theta$**

Table A .1 Measured and calculated parameters for the experiments conducted with the trash rack of  $e_1$  and  $\theta_1$

Bar Spacing: $e_1 = 3 \text{ mm}$ Angle of rack inclination: $\theta_1 = 14.477^\circ$														
Measured Parameters							Calculated Parameters							
$V_0$ (cm)	$(q_w)_r$ (lt/(s.m))	$(q_w)_t$ (lt/(s.m))	L (cm)	$L_2$ (cm)	$A_{ro}$ ( $m^2/m$ )	$V_0$ (cm/s)	$(F_r)_b$	$V_c$ (cm)	$H_c = (3/2 \gamma d)$ (cm)	$C_d$ (Eqn 2.5)	$L_2/e_1$	$L/e_1$	$(q_w)_t/(q_w)_r$	$(F_r)_e = ((q_w)_t^2 \gamma / (e_3 g))^{0.5}$
3	4.78	4.38	10	16.5	0.023	15.9	0.29	1.33	1.99	0.298	54.88	33.33	0.92	9.28
4	7.36	6.60	10	18.1	0.023	18.4	0.29	1.77	2.65	0.390	60.33	33.33	0.90	14.29
5	10.28	9.10	10	20.1	0.023	20.6	0.29	2.21	3.31	0.481	67.13	33.33	0.89	19.98
6	13.51	11.08	10	23.9	0.023	22.5	0.29	2.65	3.98	0.534	79.67	33.33	0.82	26.26
7	17.03	13.46	10	27.6	0.023	24.3	0.29	3.09	4.64	0.601	92.13	33.33	0.79	33.09
8	20.81	13.19	10	30.5	0.023	26.0	0.29	3.53	5.30	0.551	101.50	33.33	0.63	40.43
9	24.83	13.19	10	33.9	0.023	27.6	0.29	3.98	5.96	0.519	112.92	33.33	0.53	48.24
10	29.08	12.65	10	37.3	0.023	29.1	0.29	4.42	6.63	0.472	124.17	33.33	0.44	56.50
11	33.55	12.38	10	40.3	0.023	30.5	0.29	4.86	7.29	0.441	134.25	33.33	0.37	65.18
12	38.22	12.12	10	43.5	0.023	31.9	0.29	5.30	7.95	0.413	145.04	33.33	0.32	74.27
13	43.10	12.12	10	46.2	0.023	33.2	0.29	5.74	8.61	0.397	153.96	33.33	0.28	83.74
14	48.17	12.12	10	49.0	0.023	34.4	0.29	6.18	9.28	0.382	163.21	33.33	0.25	93.59
15	53.42	11.86	10	52.2	0.023	35.6	0.29	6.63	9.94	0.362	174.00	33.33	0.22	103.79
3	4.78	4.78	15	16.5	0.035	15.9	0.29	1.33	1.99	0.217	54.88	50.00	1.00	9.28
4	7.36	7.36	15	18.1	0.035	18.4	0.29	1.77	2.65	0.290	60.33	50.00	1.00	14.29
5	10.28	10.07	15	20.1	0.035	20.6	0.29	2.21	3.31	0.355	67.13	50.00	0.98	19.98
6	13.51	13.19	15	23.9	0.035	22.5	0.29	2.65	3.98	0.424	79.67	50.00	0.98	26.26
7	17.03	15.41	15	27.6	0.035	24.3	0.29	3.09	4.64	0.459	92.13	50.00	0.91	33.09
8	20.81	18.05	15	30.5	0.035	26.0	0.29	3.53	5.30	0.502	101.50	50.00	0.87	40.43
9	24.83	18.05	15	33.9	0.035	27.6	0.29	3.98	5.96	0.474	112.92	50.00	0.73	48.24
10	29.08	17.75	15	37.3	0.035	29.1	0.29	4.42	6.63	0.442	124.17	50.00	0.61	56.50
11	33.55	16.86	15	40.3	0.035	30.5	0.29	4.86	7.29	0.400	134.25	50.00	0.50	65.18
12	38.22	16.28	15	43.5	0.035	31.9	0.29	5.30	7.95	0.370	145.04	50.00	0.43	74.27
13	43.10	15.41	15	46.2	0.035	33.2	0.29	5.74	8.61	0.337	153.96	50.00	0.36	83.74
14	48.17	14.85	15	49.0	0.035	34.4	0.29	6.18	9.28	0.312	163.21	50.00	0.31	93.59
15	53.42	14.29	15	52.2	0.035	35.6	0.29	6.63	9.94	0.290	174.00	50.00	0.27	103.79



Table A.1 Continued

		Bar Spacing: $e_1 = 3 \text{ mm}$										Angle of rack inclination: $\theta_1 = 14.477^\circ$									
		Measured Parameters					Calculated Parameters					Measured Parameters					Calculated Parameters				
$y_0$ (cm)	$(q_{wh})_T$ (lt/(s.m))	$(q_{wh})_T$ (lt/(s.m))	$(q_{wh})_T$ (lt/(s.m))	$L$ (cm)	$L_2$ (cm)	$A_{w0}$ ( $m^2/m$ )	$V_0$ (cm/s)	$(F_{T0})$	$y_c$ (cm)	$H_c = (3/2 y_d)$ (cm)	$C_d$ (Eqn 2.5)	$L_2/e_1$	$L/e_1$	$(q_{wh})_T/(q_{wh})_T$	$(F_{T0})_e = ((q_{wh})_T^2/(e_3^2 g))^{0.5}$						
3	4.78	4.78	4.78	20	16.5	0.047	15.9	0.29	1.33	1.99	-	54.88	66.67	1.00	9.28						
4	7.36	7.36	7.36	20	18.1	0.047	18.4	0.29	1.77	2.65	-	60.33	66.67	1.00	14.29						
5	10.28	10.28	10.28	20	20.1	0.047	20.6	0.29	2.21	3.31	0.271	67.13	66.67	1.00	19.98						
6	13.51	12.92	12.92	20	23.9	0.047	22.5	0.29	2.65	3.98	0.311	79.67	66.67	0.96	26.26						
7	17.03	15.99	15.99	20	27.6	0.047	24.3	0.29	3.09	4.64	0.357	92.13	66.67	0.94	33.09						
8	20.81	19.27	19.27	20	30.5	0.047	26.0	0.29	3.53	5.30	0.402	101.50	66.67	0.93	40.43						
9	24.83	22.75	22.75	20	33.9	0.047	27.6	0.29	3.98	5.96	0.448	112.92	66.67	0.92	48.24						
10	29.08	26.07	26.07	20	37.3	0.047	29.1	0.29	4.42	6.63	0.487	124.17	66.67	0.90	56.50						
11	33.55	27.79	27.79	20	40.3	0.047	30.5	0.29	4.86	7.29	0.495	134.25	66.67	0.83	65.18						
12	38.22	28.14	28.14	20	43.5	0.047	31.9	0.29	5.30	7.95	0.480	145.04	66.67	0.74	74.27						
13	43.10	28.14	28.14	20	46.2	0.047	33.2	0.29	5.74	8.61	0.461	153.96	66.67	0.65	83.74						
14	48.17	27.79	27.79	20	49.0	0.047	34.4	0.29	6.18	9.28	0.439	163.21	66.67	0.58	93.59						
15	53.42	27.45	27.45	20	52.2	0.047	35.6	0.29	6.63	9.94	0.418	174.00	66.67	0.51	103.79						
3	4.78	4.78	4.78	25	16.5	0.059	15.9	0.29	1.33	1.99	-	54.88	83.33	1.00	9.28						
4	7.36	7.36	7.36	25	18.1	0.059	18.4	0.29	1.77	2.65	-	60.33	83.33	1.00	14.29						
5	10.28	10.28	10.28	25	20.1	0.059	20.6	0.29	2.21	3.31	-	67.13	83.33	1.00	19.98						
6	13.51	13.51	13.51	25	23.9	0.059	22.5	0.29	2.65	3.98	-	79.67	83.33	1.00	26.26						
7	17.03	17.03	17.03	25	27.6	0.059	24.3	0.29	3.09	4.64	0.304	92.13	83.33	1.00	33.09						
8	20.81	20.51	20.51	25	30.5	0.059	26.0	0.29	3.53	5.30	0.343	101.50	83.33	0.99	40.43						
9	24.83	24.06	24.06	25	33.9	0.059	27.6	0.29	3.98	5.96	0.379	112.92	83.33	0.97	48.24						
10	29.08	27.79	27.79	25	37.3	0.059	29.1	0.29	4.42	6.63	0.415	124.17	83.33	0.96	56.50						
11	33.55	31.70	31.70	25	40.3	0.059	30.5	0.29	4.86	7.29	0.452	134.25	83.33	0.94	65.18						
12	38.22	35.40	35.40	25	43.5	0.059	31.9	0.29	5.30	7.95	0.483	145.04	83.33	0.93	74.27						
13	43.10	36.92	36.92	25	46.2	0.059	33.2	0.29	5.74	8.61	0.484	153.96	83.33	0.86	83.74						
14	48.17	37.30	37.30	25	49.0	0.059	34.4	0.29	6.18	9.28	0.471	163.21	83.33	0.77	93.59						
15	53.42	38.07	38.07	25	52.2	0.059	35.6	0.29	6.63	9.94	0.464	174.00	83.33	0.71	103.79						

Table A .1 Continued

Bar Spacing: $e_1 = 3 \text{ mm}$ Angle of rack inclination: $\theta_1 = 14.477^\circ$														
Measured Parameters							Calculated Parameters							
$y_0 \text{ (cm)}$	$(q_w)_r \text{ (lt/(s.m))}$	$(q_w)_f \text{ (lt/(s.m))}$	$L \text{ (cm)}$	$L_2 \text{ (cm)}$	$A_w \text{ (m}^2\text{/m)}$	$V_0 \text{ (cm/s)}$	$(F_r)_0$	$y_c \text{ (cm)}$	$H_c = (3/2 y_d) \text{ (cm)}$	$C_d \text{ (Eqn 2.5)}$	$L_y/e_1$	$L/e_1$	$(q_w)_r/(q_w)_f$	$(F_r)_e = ((q_w)_r^2/(e_3 g))^{0.5}$
3	4.78	4.78	30	16.5	0.070	15.9	0.29	1.33	1.99	-	54.88	100.00	1.00	9.28
4	7.36	7.36	30	18.1	0.070	18.4	0.29	1.77	2.65	-	60.33	100.00	1.00	14.29
5	10.28	10.28	30	20.1	0.070	20.6	0.29	2.21	3.31	-	67.13	100.00	1.00	19.98
6	13.51	13.51	30	23.9	0.070	22.5	0.29	2.65	3.98	-	79.67	100.00	1.00	26.26
7	17.03	17.03	30	27.6	0.070	24.3	0.29	3.09	4.64	-	92.13	100.00	1.00	33.09
8	20.81	20.81	30	30.5	0.070	26.0	0.29	3.53	5.30	0.290	101.50	100.00	1.00	40.43
9	24.83	24.83	30	33.9	0.070	27.6	0.29	3.98	5.96	0.326	112.92	100.00	1.00	48.24
10	29.08	29.08	30	37.3	0.070	29.1	0.29	4.42	6.63	0.362	124.17	100.00	1.00	56.50
11	33.55	33.42	30	40.3	0.070	30.5	0.29	4.86	7.29	0.397	134.25	100.00	1.00	65.18
12	38.22	37.68	30	43.5	0.070	31.9	0.29	5.30	7.95	0.428	145.04	100.00	0.99	74.27
13	43.10	42.39	30	46.2	0.070	33.2	0.29	5.74	8.61	0.463	153.96	100.00	0.98	83.74
14	48.17	46.86	30	49.0	0.070	34.4	0.29	6.18	9.28	0.493	163.21	100.00	0.97	93.59
15	53.42	48.95	30	52.2	0.070	35.6	0.29	6.63	9.94	0.497	174.00	100.00	0.92	103.79
3	4.78	4.78	35	16.5	0.082	15.9	0.29	1.33	1.99	-	54.88	116.67	1.00	9.28
4	7.36	7.36	35	18.1	0.082	18.4	0.29	1.77	2.65	-	60.33	116.67	1.00	14.29
5	10.28	10.28	35	20.1	0.082	20.6	0.29	2.21	3.31	-	67.13	116.67	1.00	19.98
6	13.51	13.51	35	23.9	0.082	22.5	0.29	2.65	3.98	-	79.67	116.67	1.00	26.26
7	17.03	17.03	35	27.6	0.082	24.3	0.29	3.09	4.64	-	92.13	116.67	1.00	33.09
8	20.81	20.81	35	30.5	0.082	26.0	0.29	3.53	5.30	-	101.50	116.67	1.00	40.43
9	24.83	24.83	35	33.9	0.082	27.6	0.29	3.98	5.96	-	112.92	116.67	1.00	48.24
10	29.08	29.08	35	37.3	0.082	29.1	0.29	4.42	6.63	0.310	124.17	116.67	1.00	56.50
11	33.55	33.53	35	40.3	0.082	30.5	0.29	4.86	7.29	0.341	134.25	116.67	1.00	65.18
12	38.22	38.07	35	43.5	0.082	31.9	0.29	5.30	7.95	0.371	145.04	116.67	1.00	74.27
13	43.10	42.79	35	46.2	0.082	33.2	0.29	5.74	8.61	0.400	153.96	116.67	0.99	83.74
14	48.17	47.28	35	49.0	0.082	34.4	0.29	6.18	9.28	0.426	163.21	116.67	0.98	93.59
15	53.42	51.91	35	52.2	0.082	35.6	0.29	6.63	9.94	0.452	174.00	116.67	0.97	103.79

Table A .1 Continued

Bar Spacing: $e_1 = 3 \text{ mm}$ Angle of rack inclination: $\theta_1 = 14.47^\circ$														
Measured Parameters										Calculated Parameters				
$\gamma_0 \text{ (cm)}$	$(q_{wh})_T \text{ (lt/(s.m))}$	$(q_{wh})_h \text{ (lt/(s.m))}$	$L \text{ (cm)}$	$L_2 \text{ (cm)}$	$A_{w0} \text{ (m}^2\text{/m)}$	$V_0 \text{ (cm/s)}$	$(F_r)_0$	$\gamma_c \text{ (cm)}$	$H_c = (3/2 \gamma_0) \text{ (cm)}$	$C_c \text{ (Eqn 2.5)}$	$L_2/e_1$	$L/e_1$	$(q_{wh})_r/(q_{wh})_T$	$(F_r)_e = ((q_{wh})_r^2/(e_3^2 g))^{0.5}$
3	4.78	4.78	40	16.5	0.094	15.9	0.25	1.33	1.99	-	54.88	133.33	1.00	9.28
4	7.36	7.36	40	18.1	0.094	18.4	0.25	1.77	2.65	-	60.33	133.33	1.00	14.29
5	10.28	10.28	40	20.1	0.094	20.6	0.25	2.21	3.31	-	67.13	133.33	1.00	19.98
6	13.51	13.51	40	23.9	0.094	22.5	0.25	2.65	3.98	-	79.67	133.33	1.00	26.26
7	17.03	17.03	40	27.6	0.094	24.3	0.25	3.09	4.64	-	92.13	133.33	1.00	33.09
8	20.81	20.81	40	30.5	0.094	26.0	0.25	3.53	5.30	-	101.50	133.33	1.00	40.43
9	24.83	24.83	40	33.9	0.094	27.6	0.25	3.98	5.96	-	112.92	133.33	1.00	48.24
10	29.08	29.08	40	37.3	0.094	29.1	0.25	4.42	6.63	-	124.17	133.33	1.00	56.50
11	33.55	33.55	40	40.3	0.094	30.5	0.25	4.86	7.29	0.299	134.25	133.33	1.00	65.18
12	38.22	38.22	40	43.5	0.094	31.9	0.25	5.30	7.95	0.326	145.04	133.33	1.00	74.27
13	43.10	42.39	40	46.2	0.094	33.2	0.25	5.74	8.61	0.347	153.96	133.33	0.98	83.74
14	48.17	46.86	40	49.0	0.094	34.4	0.25	6.18	9.28	0.370	163.21	133.33	0.97	93.59
15	53.42	51.48	40	52.2	0.094	35.6	0.25	6.63	9.94	0.392	174.00	133.33	0.96	103.79

Table A .2 Measured and calculated parameters for the experiments conducted with the trash rack of  $e_1$  and  $\theta_2$

Bar Spacing: $e_1 = 3 \text{ mm}$ Angle of rack inclination: $\theta_2 = 9.594^\circ$														
Measured Parameters							Calculated Parameters							
$V_0$ (cm)	$(q_w)_H$ (lt/(s.m))	$(q_w)_L$ (lt/(s.m))	$L$ (cm)	$L_2$ (cm)	$A_{co}$ ( $\text{m}^2/\text{m}$ )	$V_0$ (cm/s)	$(F_1)_0$	$v_c$ (cm)	$H_c = (3/2 v_d)$ (cm)	$C_d$ (Eqn 2.5)	$L_2/e_1$	$L/e_1$	$(q_w)_L/(q_w)_H$	$(F_1)_e = ((q_w)_L^2/(e_3 g))^{0.5}$
3	4.78	4.78	10	11.2	0.023	15.9	0.29	1.33	1.99	0.326	37.17	33.33	1.00	9.28
4	7.36	7.25	10	13.9	0.023	18.4	0.29	1.77	2.65	0.428	46.33	33.33	0.99	14.29
5	10.28	10.07	10	17.5	0.023	20.6	0.29	2.21	3.31	0.532	58.33	33.33	0.98	19.98
6	13.51	13.19	10	20.9	0.023	22.5	0.29	2.65	3.98	0.636	69.54	33.33	0.98	26.26
7	17.03	15.13	10	24.6	0.023	24.3	0.29	3.09	4.64	0.675	81.83	33.33	0.89	33.09
8	20.81	14.85	10	27.4	0.023	26.0	0.29	3.53	5.30	0.620	91.17	33.33	0.71	40.43
9	24.83	15.41	10	30.9	0.023	27.6	0.29	3.98	5.96	0.607	102.92	33.33	0.62	48.24
10	29.08	15.70	10	34.3	0.023	29.1	0.29	4.42	6.63	0.586	114.25	33.33	0.54	56.50
11	33.55	15.70	10	37.5	0.023	30.5	0.29	4.86	7.29	0.559	124.96	33.33	0.47	65.18
12	38.22	15.99	10	42.2	0.023	31.9	0.29	5.30	7.95	0.545	140.63	33.33	0.42	74.27
13	43.10	16.28	10	43.8	0.023	33.2	0.29	5.74	8.61	0.533	146.00	33.33	0.38	83.74
14	48.17	16.57	10	45.1	0.023	34.4	0.29	6.18	9.28	0.523	150.33	33.33	0.34	93.59
15	53.42	16.57	10	47.6	0.023	35.6	0.29	6.63	9.94	0.505	158.67	33.33	0.31	103.79
3	4.78	4.78	15	11.2	0.035	15.9	0.29	1.33	1.99	-	37.17	50.00	1.00	9.28
4	7.36	7.36	15	13.9	0.035	18.4	0.29	1.77	2.65	-	46.33	50.00	1.00	14.29
5	10.28	10.28	15	17.5	0.035	20.6	0.29	2.21	3.31	0.362	58.33	50.00	1.00	19.98
6	13.51	13.46	15	20.9	0.035	22.5	0.29	2.65	3.98	0.433	69.54	50.00	1.00	26.26
7	17.03	16.28	15	24.6	0.035	24.3	0.29	3.09	4.64	0.484	81.83	50.00	0.96	33.09
8	20.81	19.58	15	27.4	0.035	26.0	0.29	3.53	5.30	0.545	91.17	50.00	0.94	40.43
9	24.83	22.75	15	30.9	0.035	27.6	0.29	3.98	5.96	0.597	102.92	50.00	0.92	48.24
10	29.08	24.06	15	34.3	0.035	29.1	0.29	4.42	6.63	0.599	114.25	50.00	0.83	56.50
11	33.55	24.73	15	37.5	0.035	30.5	0.29	4.86	7.29	0.587	124.96	50.00	0.74	65.18
12	38.22	25.73	15	42.2	0.035	31.9	0.29	5.30	7.95	0.585	140.63	50.00	0.67	74.27
13	43.10	26.41	15	43.8	0.035	33.2	0.29	5.74	8.61	0.577	146.00	50.00	0.61	83.74
14	48.17	27.10	15	45.1	0.035	34.4	0.29	6.18	9.28	0.570	150.33	50.00	0.56	93.59
15	53.42	27.79	15	47.6	0.035	35.6	0.29	6.63	9.94	0.565	158.67	50.00	0.52	103.79

Table A.2 Continued

Bar Spacing: $e_1 = 3$ mm      Angle of rack inclination: $\theta_2 = 9.594^\circ$														
Measured Parameters										Calculated Parameters				
$V_0$ (cm)	$(q_{wh})_T$ (lt/(s.m))	$(q_{wh})_T$ (lt/(s.m))	L (cm)	$L_2$ (cm)	$A_{r0}$ (m <sup>2</sup> /m)	$V_0$ (cm/s)	$(F_{Tj})_0$	$\gamma_c$ (cm)	$H_{Tc} = (3/2 \text{ yd})$ (cm)	$C_d$ (Eqn 2.5)	$L_2/\epsilon_1$	$L/\epsilon_1$	$(q_{wh})_T/(q_{wh})_T$	$(F_{Tj})_e = ((q_{wh})_T^2 / (\epsilon_3 g))^{0.5}$
3	4.78	4.78	20	11.2	0.047	15.9	0.29	1.33	1.99	-	37.17	66.67	1.00	9.28
4	7.36	7.36	20	13.9	0.047	18.4	0.29	1.77	2.65	-	46.33	66.67	1.00	14.29
5	10.28	10.28	20	17.5	0.047	20.6	0.29	2.21	3.31	-	58.33	66.67	1.00	19.98
6	13.51	13.51	20	20.9	0.047	22.5	0.29	2.65	3.98	0.326	69.54	66.67	1.00	26.26
7	17.03	16.57	20	24.6	0.047	24.3	0.29	3.09	4.64	0.370	81.83	66.67	0.97	33.09
8	20.81	20.20	20	27.4	0.047	26.0	0.29	3.53	5.30	0.422	91.17	66.67	0.97	40.43
9	24.83	23.93	20	30.9	0.047	27.6	0.29	3.98	5.96	0.471	102.92	66.67	0.96	48.24
10	29.08	27.97	20	34.3	0.047	29.1	0.29	4.42	6.63	0.522	114.25	66.67	0.96	56.50
11	33.55	32.06	20	37.5	0.047	30.5	0.29	4.86	7.29	0.571	124.96	66.67	0.96	65.18
12	38.22	33.90	20	42.2	0.047	31.9	0.29	5.30	7.95	0.578	140.63	66.67	0.89	74.27
13	43.10	35.40	20	43.8	0.047	33.2	0.29	5.74	8.61	0.580	146.00	66.67	0.82	83.74
14	48.17	36.15	20	45.1	0.047	34.4	0.29	6.18	9.28	0.571	150.33	66.67	0.75	93.59
15	53.42	37.30	20	47.6	0.047	35.6	0.29	6.63	9.94	0.569	158.67	66.67	0.70	103.79
3	4.78	4.78	25	11.2	0.059	15.9	0.29	1.33	1.99	-	37.17	83.33	1.00	9.28
4	7.36	7.36	25	13.9	0.059	18.4	0.29	1.77	2.65	-	46.33	83.33	1.00	14.29
5	10.28	10.28	25	17.5	0.059	20.6	0.29	2.21	3.31	-	58.33	83.33	1.00	19.98
6	13.51	13.51	25	20.9	0.059	22.5	0.29	2.65	3.98	-	69.54	83.33	1.00	26.26
7	17.03	17.03	25	24.6	0.059	24.3	0.29	3.09	4.64	0.304	81.83	83.33	1.00	33.09
8	20.81	20.81	25	27.4	0.059	26.0	0.29	3.53	5.30	0.347	91.17	83.33	1.00	40.43
9	24.83	24.39	25	30.9	0.059	27.6	0.29	3.98	5.96	0.384	102.92	83.33	0.98	48.24
10	29.08	28.49	25	34.3	0.059	29.1	0.29	4.42	6.63	0.426	114.25	83.33	0.98	56.50
11	33.55	32.43	25	37.5	0.059	30.5	0.29	4.86	7.29	0.462	124.96	83.33	0.97	65.18
12	38.22	36.53	25	42.2	0.059	31.9	0.29	5.30	7.95	0.498	140.63	83.33	0.96	74.27
13	43.10	40.80	25	43.8	0.059	33.2	0.29	5.74	8.61	0.535	146.00	83.33	0.95	83.74
14	48.17	43.59	25	45.1	0.059	34.4	0.29	6.18	9.28	0.550	150.33	83.33	0.91	93.59
15	53.42	44.81	25	47.6	0.059	35.6	0.29	6.63	9.94	0.547	158.67	83.33	0.84	103.79

Table A.2 Continued

		Bar Spacing: $e_1 = 3$ mm										Angle of rack inclination: $\theta_2 = 9.594^\circ$									
		Measured Parameters					Calculated Parameters					Measured Parameters					Calculated Parameters				
$y_0$ (cm)	$(q_{wh})_r$ (ft/(s.m))	$(q_{wh})_l$ (ft/(s.m))	L (cm)	$L_2$ (cm)	$A_{90}$ (m <sup>2</sup> /m)	$V_0$ (cm/s)	$(F_r)_{90}$	$y_c$ (cm)	$H_c = (3/2 y_d)$ (cm)	$C_d$ (Eqn 2.5)	$L_2/e_1$	$L/e_1$	$(q_{wh})_l/(q_{wh})_r$	$(F_r)_c = ((q_{wh})_l^2/(e_3 B))^{0.5}$							
3	4.78	4.78	30	11.2	0.070	15.9	0.29	1.33	1.99	-	37.17	100.00	1.00	9.28							
4	7.36	7.36	30	13.9	0.070	18.4	0.29	1.77	2.65	-	46.33	100.00	1.00	14.29							
5	10.28	10.28	30	17.5	0.070	20.6	0.29	2.21	3.31	-	58.33	100.00	1.00	19.98							
6	13.51	13.51	30	20.9	0.070	22.5	0.29	2.65	3.98	-	69.54	100.00	1.00	26.26							
7	17.03	17.03	30	24.6	0.070	24.3	0.29	3.09	4.64	-	81.83	100.00	1.00	33.09							
8	20.81	20.81	30	27.4	0.070	26.0	0.29	3.53	5.30	-	91.17	100.00	1.00	40.43							
9	24.83	24.83	30	30.9	0.070	27.6	0.29	3.98	5.96	0.326	102.92	100.00	1.00	48.24							
10	29.08	29.08	30	34.3	0.070	29.1	0.29	4.42	6.63	0.362	114.25	100.00	1.00	56.50							
11	33.55	33.55	30	37.5	0.070	30.5	0.29	4.86	7.29	0.398	124.96	100.00	1.00	65.18							
12	38.22	37.30	30	42.2	0.070	31.9	0.29	5.30	7.95	0.424	140.63	100.00	0.98	74.27							
13	43.10	41.59	30	43.8	0.070	33.2	0.29	5.74	8.61	0.454	146.00	100.00	0.97	83.74							
14	48.17	45.63	30	45.1	0.070	34.4	0.29	6.18	9.28	0.480	150.33	100.00	0.95	93.59							
15	53.42	50.21	30	47.6	0.070	35.6	0.29	6.63	9.94	0.510	158.67	100.00	0.94	103.79							
3	4.78	4.78	35	11.2	0.082	15.9	0.29	1.33	1.99	-	37.17	116.67	1.00	9.28							
4	7.36	7.36	35	13.9	0.082	18.4	0.29	1.77	2.65	-	46.33	116.67	1.00	14.29							
5	10.28	10.28	35	17.5	0.082	20.6	0.29	2.21	3.31	-	58.33	116.67	1.00	19.98							
6	13.51	13.51	35	20.9	0.082	22.5	0.29	2.65	3.98	-	69.54	116.67	1.00	26.26							
7	17.03	17.03	35	24.6	0.082	24.3	0.29	3.09	4.64	-	81.83	116.67	1.00	33.09							
8	20.81	20.81	35	27.4	0.082	26.0	0.29	3.53	5.30	-	91.17	116.67	1.00	40.43							
9	24.83	24.83	35	30.9	0.082	27.6	0.29	3.98	5.96	-	102.92	116.67	1.00	48.24							
10	29.08	29.08	35	34.3	0.082	29.1	0.29	4.42	6.63	0.310	114.25	116.67	1.00	56.50							
11	33.55	33.55	35	37.5	0.082	30.5	0.29	4.86	7.29	0.341	124.96	116.67	1.00	65.18							
12	38.22	38.22	35	42.2	0.082	31.9	0.29	5.30	7.95	0.372	140.63	116.67	1.00	74.27							
13	43.10	42.39	35	43.8	0.082	33.2	0.29	5.74	8.61	0.397	146.00	116.67	0.98	83.74							
14	48.17	46.86	35	45.1	0.082	34.4	0.29	6.18	9.28	0.423	150.33	116.67	0.97	93.59							
15	53.42	50.63	35	47.6	0.082	35.6	0.29	6.63	9.94	0.441	158.67	116.67	0.95	103.79							

Table A .2 Continued

Bar Spacing: $e_1 = 3 \text{ mm}$ Angle of rack inclination: $\theta_2 = 9.594^\circ$														
Measured Parameters										Calculated Parameters				
$\gamma_0$ (cm)	$(q_{wh})_i$ (lt/(s.m))	$(q_{wh})_i$ (lt/(s.m))	L (cm)	$L_2$ (cm)	$A_{90}$ ( $\text{m}^2/\text{m}$ )	$V_0$ (cm/s)	$(F_{fl})_e$	$\gamma_c$ (cm)	$H_c = (3/2 \gamma_c)$ (cm)	$C_d$ (Eqn 2.5)	$L_2/e_1$	$L/e_1$	$(q_{wh})_i/(q_{wh})_T$	$(F_{fl})_e = ((q_{wh})_T^2/(e_1^3 g))^{0.5}$
3	4.78	4.78	40	11.2	0.094	15.9	0.29	1.33	1.99	-	37.17	133.33	1.00	9.28
4	7.36	7.36	40	13.9	0.094	18.4	0.29	1.77	2.65	-	46.33	133.33	1.00	14.29
5	10.28	10.28	40	17.5	0.094	20.6	0.29	2.21	3.31	-	58.33	133.33	1.00	19.98
6	13.51	13.51	40	20.9	0.094	22.5	0.29	2.65	3.98	-	59.54	133.33	1.00	26.26
7	17.03	17.03	40	24.6	0.094	24.3	0.29	3.09	4.64	-	81.83	133.33	1.00	33.09
8	20.81	20.81	40	27.4	0.094	26.0	0.29	3.53	5.30	-	91.17	133.33	1.00	40.43
9	24.83	24.83	40	30.9	0.094	27.6	0.29	3.98	5.96	-	102.92	133.33	1.00	48.24
10	29.08	29.08	40	34.3	0.094	29.1	0.29	4.42	6.63	-	114.25	133.33	1.00	56.50
11	33.55	33.55	40	37.5	0.094	30.5	0.29	4.86	7.29	-	124.96	133.33	1.00	65.18
12	38.22	38.22	40	42.2	0.094	31.9	0.29	5.30	7.95	0.326	140.63	133.33	1.00	74.27
13	43.10	43.10	40	43.8	0.094	33.2	0.29	5.74	8.61	0.353	146.00	133.33	1.00	83.74
14	48.17	47.69	40	45.1	0.094	34.4	0.29	6.18	9.28	0.376	150.33	133.33	0.99	93.59
15	53.42	52.34	40	47.6	0.094	35.6	0.29	6.63	9.94	0.399	158.67	133.33	0.98	103.79

Table A.3 Measured and calculated parameters for the experiments conducted with the trash rack of  $e_1$  and  $\theta_3$

Bar Spacing: $e_1 = 3 \text{ mm}$ Angle of rack inclination: $\theta_3 = 4.780^\circ$														
Measured Parameters							Calculated Parameters							
$V_0$ (cm)	$(q_w)_T$ (lt/(s.m))	$(q_w)_c$ (lt/(s.m))	L (cm)	$L_2$ (cm)	$A_w$ ( $\text{m}^2/\text{m}$ )	$V_0$ (cm/s)	$(F_c)_0$	$V_c$ (cm)	$H_c = (3/2 \gamma d)$ (cm)	$C_d$ (Eqn 2.5)	$L_2/e_1$	$L/e_1$	$(q_w)_c/(q_w)_T$	$(F_c)_e = ((q_w)_c^2/(e_3 g))^{0.5}$
3	4.78	4.78	10	11.1	0.023	15.9	0.29	1.33	1.99	0.326	36.83	33.33	1.00	9.28
4	7.36	7.36	10	13.8	0.023	18.4	0.29	1.77	2.65	0.434	45.92	33.33	1.00	14.29
5	10.28	10.07	10	17.4	0.023	20.6	0.29	2.21	3.31	0.532	57.96	33.33	0.98	19.98
6	13.51	12.65	10	19.8	0.023	22.5	0.29	2.65	3.98	0.610	65.92	33.33	0.94	26.26
7	17.03	15.41	10	23.0	0.023	24.3	0.29	3.09	4.64	0.688	76.58	33.33	0.91	33.09
8	20.81	16.57	10	26.0	0.023	26.0	0.29	3.53	5.30	0.692	86.75	33.33	0.80	40.43
9	24.83	17.16	10	30.6	0.023	27.6	0.29	3.98	5.96	0.675	101.88	33.33	0.69	48.24
10	29.08	18.05	10	32.8	0.023	29.1	0.29	4.42	6.63	0.674	109.21	33.33	0.62	56.50
11	33.55	18.66	10	34.1	0.023	30.5	0.29	4.86	7.29	0.664	113.50	33.33	0.56	65.18
12	38.22	19.58	10	37.0	0.023	31.9	0.29	5.30	7.95	0.667	123.21	33.33	0.51	74.27
13	43.10	20.51	10	39.7	0.023	33.2	0.29	5.74	8.61	0.672	132.17	33.33	0.48	83.74
14	48.17	21.14	10	41.8	0.023	34.4	0.29	6.18	9.28	0.667	139.25	33.33	0.44	93.59
15	53.42	21.78	10	44.4	0.023	35.6	0.29	6.63	9.94	0.664	147.83	33.33	0.41	103.79
3	4.78	4.78	15	11.1	0.035	15.9	0.29	1.33	1.99	-	36.83	50.00	1.00	9.28
4	7.36	7.36	15	13.8	0.035	18.4	0.29	1.77	2.65	-	45.92	50.00	1.00	14.29
5	10.28	10.28	15	17.4	0.035	20.6	0.29	2.21	3.31	0.362	57.96	50.00	1.00	19.98
6	13.51	13.51	15	19.8	0.035	22.5	0.29	2.65	3.98	0.434	65.92	50.00	1.00	26.26
7	17.03	16.83	15	23.0	0.035	24.3	0.29	3.09	4.64	0.501	76.58	50.00	0.99	33.09
8	20.81	20.20	15	26.0	0.035	26.0	0.29	3.53	5.30	0.562	86.75	50.00	0.97	40.43
9	24.83	23.34	15	30.6	0.035	27.6	0.29	3.98	5.96	0.612	101.88	50.00	0.94	48.24
10	29.08	26.07	15	32.8	0.035	29.1	0.29	4.42	6.63	0.649	109.21	50.00	0.90	56.50
11	33.55	28.49	15	34.1	0.035	30.5	0.29	4.86	7.29	0.676	113.50	50.00	0.85	65.18
12	38.22	31.34	15	37.0	0.035	31.9	0.29	5.30	7.95	0.712	123.21	50.00	0.82	74.27
13	43.10	32.80	15	39.7	0.035	33.2	0.29	5.74	8.61	0.716	132.17	50.00	0.76	83.74
14	48.17	33.16	15	41.8	0.035	34.4	0.29	6.18	9.28	0.698	139.25	50.00	0.69	93.59
15	53.42	32.43	15	44.4	0.035	35.6	0.29	6.63	9.94	0.659	147.83	50.00	0.61	103.79



Table A.3 Continued

Bar Spacing: $e_1 = 3 \text{ mm}$ Angle of rack inclination: $\theta_3 = 4.780^\circ$														
Measured Parameters							Calculated Parameters							
$y_0 \text{ (cm)}$	$(q_{wh})_T \text{ (lt/(s.m))}$	$(q_{wh})_T \text{ (lt/(s.m))}$	$L_2 \text{ (cm)}$	$L_1 \text{ (cm)}$	$A_{90} \text{ (m}^2\text{/m)}$	$V_0 \text{ (cm/s)}$	$(F_{j0})$	$y_c \text{ (cm)}$	$H_c = (3/2) y_0 \text{ (cm)}$	$C_d \text{ (Eqn 2.5)}$	$L_2/e_1$	$L_1/e_1$	$(q_{wh})_T/(q_{wh})_T$	$(F_{j0})_c = ((q_{wh})_T^2/(e_3^3 g))^{0.5}$
3	4.78	4.78	20	11.1	0.047	15.9	0.29	1.33	1.99	-	36.83	66.67	1.00	9.28
4	7.36	7.36	20	13.8	0.047	18.4	0.29	1.77	2.65	-	45.92	66.67	1.00	14.29
5	10.28	10.28	20	17.4	0.047	20.6	0.29	2.21	3.31	-	57.96	66.67	1.00	19.98
6	13.51	13.51	20	19.8	0.047	22.5	0.29	2.65	3.98	0.326	65.92	66.67	1.00	26.26
7	17.03	17.03	20	23.0	0.047	24.3	0.29	3.09	4.64	0.380	76.58	66.67	1.00	33.09
8	20.81	20.81	20	26.0	0.047	26.0	0.29	3.53	5.30	0.432	86.75	66.67	0.99	40.43
9	24.83	23.73	20	30.6	0.047	27.6	0.29	3.98	5.96	0.467	101.88	66.67	0.96	48.24
10	29.08	27.27	20	32.8	0.047	29.1	0.29	4.42	6.63	0.509	109.21	66.67	0.94	56.50
11	33.55	30.80	20	34.1	0.047	30.5	0.29	4.86	7.29	0.548	113.50	66.67	0.92	65.18
12	38.22	34.27	20	37.0	0.047	31.9	0.29	5.30	7.95	0.584	123.21	66.67	0.90	74.27
13	43.10	37.68	20	39.7	0.047	33.2	0.29	5.74	8.61	0.617	132.17	66.67	0.87	83.74
14	48.17	39.62	20	41.8	0.047	34.4	0.29	6.18	9.28	0.625	139.25	66.67	0.82	93.59
15	53.42	40.80	20	44.4	0.047	35.6	0.29	6.63	9.94	0.622	147.83	66.67	0.76	103.79
3	4.78	4.78	25	11.1	0.059	15.9	0.29	1.33	1.99	-	36.83	83.33	1.00	9.28
4	7.36	7.36	25	13.8	0.059	18.4	0.29	1.77	2.65	-	45.92	83.33	1.00	14.29
5	10.28	10.28	25	17.4	0.059	20.6	0.29	2.21	3.31	-	57.96	83.33	1.00	19.98
6	13.51	13.51	25	19.8	0.059	22.5	0.29	2.65	3.98	-	65.92	83.33	1.00	26.26
7	17.03	17.03	25	23.0	0.059	24.3	0.29	3.09	4.64	-	76.58	83.33	1.00	33.09
8	20.81	20.81	25	26.0	0.059	26.0	0.29	3.53	5.30	0.347	86.75	83.33	1.00	40.43
9	24.83	24.83	25	30.6	0.059	27.6	0.29	3.98	5.96	0.391	101.88	83.33	1.00	48.24
10	29.08	28.74	25	32.8	0.059	29.1	0.29	4.42	6.63	0.429	109.21	83.33	0.99	56.50
11	33.55	32.80	25	34.1	0.059	30.5	0.29	4.86	7.29	0.467	113.50	83.33	0.98	65.18
12	38.22	36.53	25	37.0	0.059	31.9	0.29	5.30	7.95	0.498	123.21	83.33	0.96	74.27
13	43.10	40.80	25	39.7	0.059	33.2	0.29	5.74	8.61	0.535	132.17	83.33	0.95	83.74
14	48.17	44.81	25	41.8	0.059	34.4	0.29	6.18	9.28	0.566	139.25	83.33	0.93	93.59
15	53.42	48.53	25	44.4	0.059	35.6	0.29	6.63	9.94	0.592	147.83	83.33	0.91	103.79

Table A.3 Continued

Bar Spacing: $e_1 = 3 \text{ mm}$ Angle of rack inclination: $\theta_3 = 4.780^\circ$														
Measured Parameters							Calculated Parameters							
$Y_0 \text{ (cm)}$	$(q_{wh})_T \text{ (lt/(s.m))}$	$(q_{wh})_i \text{ (lt/(s.m))}$	$L \text{ (cm)}$	$L_2 \text{ (cm)}$	$A_{ro} \text{ (m}^2/\text{m)}$	$V_0 \text{ (cm/s)}$	$(F_{rlo})$	$Y_c \text{ (cm)}$	$H_C = (3/2 \gamma d) \text{ (cm)}$	$C_d \text{ (Eqn 2.5)}$	$L_2/e_1$	$L/e_1$	$(q_{wh})_i/(q_{wh})_T$	$(F_r)_e = ((q_{wh})_T^2/(e_3^3 g))^{0.5}$
3	4.78	4.78	30	11.1	0.070	15.9	0.29	1.33	1.99	-	36.83	100.00	1.00	9.28
4	7.36	7.36	30	13.8	0.070	18.4	0.29	1.77	2.65	-	45.92	100.00	1.00	14.29
5	10.28	10.28	30	17.4	0.070	20.6	0.29	2.21	3.31	-	57.96	100.00	1.00	19.98
6	13.51	13.51	30	19.8	0.070	22.5	0.29	2.65	3.98	-	65.92	100.00	1.00	26.26
7	17.03	17.03	30	23.0	0.070	24.3	0.29	3.09	4.64	-	76.58	100.00	1.00	33.09
8	20.81	20.81	30	26.0	0.070	26.0	0.29	3.53	5.30	-	86.75	100.00	1.00	40.43
9	24.83	24.83	30	30.6	0.070	27.6	0.29	3.98	5.96	0.326	101.88	100.00	1.00	48.24
10	29.08	29.08	30	32.8	0.070	29.1	0.29	4.42	6.63	0.362	109.21	100.00	1.00	56.50
11	33.55	33.16	30	34.1	0.070	30.5	0.29	4.86	7.29	0.394	113.50	100.00	0.99	65.18
12	38.22	37.68	30	37.0	0.070	31.9	0.29	5.30	7.95	0.428	123.21	100.00	0.99	74.27
13	43.10	42.19	30	39.7	0.070	33.2	0.29	5.74	8.61	0.461	132.17	100.00	0.98	83.74
14	48.17	46.66	30	41.8	0.070	34.4	0.29	6.18	9.28	0.491	139.25	100.00	0.97	93.59
15	53.42	51.48	30	44.4	0.070	35.6	0.29	6.63	9.94	0.523	147.83	100.00	0.96	103.79

Table A.4 Measured and calculated parameters for the experiments conducted with the trash rack of  $e_2$  and  $\theta_1$

		Bar Spacing: $e_2 = 6 \text{ mm}$										Angle of rack inclination: $\theta_1 = 14.477^\circ$									
		Measured Parameters					Calculated Parameters					Measured Parameters					Calculated Parameters				
$y_0$ (cm)	$(q_{wT})_T$ (lt/(s.m))	$(q_{wT})_C$ (lt/(s.m))	$L$ (cm)	$L_2$ (cm)	$A_{oc}$ ( $m^2/m$ )	$V_0$ (cm/s)	$(F_{T0})$	$y_c$ (cm)	$H_c = (3/2 y_0)$ (cm)	$C_d$ (Eqn 2.5)	$L_2/e_2$	$L/e_2$	$(q_{wT})_C/(q_{wT})_T$	$(F_{T1})_e = ((q_{wT})_C^2/(e_3 g))^{0.5}$							
3	4.78	4.57	5	13.8	0.019	15.9	0.29	1.33	1.99	0.386	23.06	8.33	0.96	3.28							
4	7.36	6.38	5	16.2	0.019	18.4	0.29	1.77	2.65	0.467	26.92	8.33	0.87	5.05							
5	10.28	8.16	5	18.3	0.019	20.6	0.29	2.21	3.31	0.534	30.52	8.33	0.79	7.06							
6	13.51	9.70	5	20.6	0.019	22.5	0.29	2.65	3.98	0.580	34.25	8.33	0.72	9.28							
7	17.03	10.32	5	23.0	0.019	24.3	0.29	3.09	4.64	0.571	38.31	8.33	0.61	11.70							
8	20.81	10.32	5	26.2	0.019	26.0	0.29	3.53	5.30	0.534	43.58	8.33	0.50	14.29							
9	24.83	10.57	5	29.3	0.019	27.6	0.29	3.98	5.96	0.516	48.77	8.33	0.43	17.06							
10	29.08	10.82	5	31.3	0.019	29.1	0.29	4.42	6.63	0.501	52.23	8.33	0.37	19.98							
11	33.55	11.08	5	34.2	0.019	30.5	0.29	4.86	7.29	0.489	57.02	8.33	0.33	23.05							
12	38.22	11.08	5	36.7	0.019	31.9	0.29	5.30	7.95	0.468	61.21	8.33	0.29	26.26							
13	43.10	11.34	5	39.6	0.019	33.2	0.29	5.74	8.61	0.460	66.00	8.33	0.26	29.61							
14	48.17	11.59	5	41.0	0.019	34.4	0.29	6.18	9.28	0.454	68.40	8.33	0.24	33.09							
15	53.42	11.08	5	43.6	0.019	35.6	0.29	6.63	9.94	0.419	72.60	8.33	0.21	36.70							
3	4.78	4.78	10	13.8	0.038	15.9	0.29	1.33	1.99	0.202	23.06	16.67	1.00	3.28							
4	7.36	7.25	10	16.2	0.038	18.4	0.29	1.77	2.65	0.265	26.92	16.67	0.99	5.05							
5	10.28	10.07	10	18.3	0.038	20.6	0.29	2.21	3.31	0.330	30.52	16.67	0.98	7.06							
6	13.51	12.92	10	20.6	0.038	22.5	0.29	2.65	3.98	0.386	34.25	16.67	0.96	9.28							
7	17.03	15.41	10	23.0	0.038	24.3	0.29	3.09	4.64	0.427	38.31	16.67	0.91	11.70							
8	20.81	18.35	10	26.2	0.038	26.0	0.29	3.53	5.30	0.475	43.58	16.67	0.88	14.29							
9	24.83	20.83	10	29.3	0.038	27.6	0.29	3.98	5.96	0.508	48.77	16.67	0.84	17.06							
10	29.08	23.40	10	31.3	0.038	29.1	0.29	4.42	6.63	0.542	52.23	16.67	0.80	19.98							
11	33.55	23.40	10	34.2	0.038	30.5	0.29	4.86	7.29	0.517	57.02	16.67	0.70	23.05							
12	38.22	23.40	10	36.7	0.038	31.9	0.29	5.30	7.95	0.495	61.21	16.67	0.61	26.26							
13	43.10	23.40	10	39.6	0.038	33.2	0.29	5.74	8.61	0.475	66.00	16.67	0.54	29.61							
14	48.17	23.07	10	41.0	0.038	34.4	0.29	6.18	9.28	0.452	68.40	16.67	0.48	33.09							
15	53.42	23.07	10	43.6	0.038	35.6	0.29	6.63	9.94	0.436	72.60	16.67	0.43	36.70							

Table A.4 Continued

Bar Spacing: $e_2 = 6$ mm															Angle of rack inclination: $\theta_1 = 14.477^\circ$														
Measured Parameters															Calculated Parameters														
$v_0$ (cm)	$(q_w)_T$ (ft/(s·m))	$(q_w)_i$ (ft/(s·m))	L (cm)	$L_2$ (cm)	$A_w$ (m <sup>2</sup> /m)	$V_0$ (cm/s)	$(F)_0$	$\gamma_c$ (cm)	$H_c = (3/2) \gamma_D$ (cm)	$C_d$ (Eqn 2.5)	$L_2/e_2$	$L/e_2$	$(q_w)_i/(q_w)_T$	$(F)_e = ((q_w)_T^2/(e_3 g))^{0.5}$															
3	4.78	4.78	15	13.8	0.057	15.9	0.29	1.33	1.99	-	23.06	25.00	1.00	3.28															
4	7.36	7.36	15	16.2	0.057	18.4	0.29	1.77	2.65	0.180	26.92	25.00	1.00	5.05															
5	10.28	10.07	15	18.3	0.057	20.6	0.29	2.21	3.31	0.220	30.52	25.00	0.98	7.06															
6	13.51	13.19	15	20.6	0.057	22.5	0.29	2.65	3.98	0.263	34.25	25.00	0.98	9.28															
7	17.03	16.69	15	23.0	0.057	24.3	0.29	3.09	4.64	0.308	38.31	25.00	0.98	11.70															
8	20.81	20.20	15	26.2	0.057	26.0	0.29	3.53	5.30	0.349	43.58	25.00	0.97	14.29															
9	24.83	23.83	15	29.3	0.057	27.6	0.29	3.98	5.96	0.388	48.77	25.00	0.96	17.06															
10	29.08	27.45	15	31.3	0.057	29.1	0.29	4.42	6.63	0.424	52.23	25.00	0.94	19.98															
11	33.55	31.34	15	34.2	0.057	30.5	0.29	4.86	7.29	0.461	57.02	25.00	0.93	23.05															
12	38.22	34.27	15	36.7	0.057	31.9	0.29	5.30	7.95	0.483	61.21	25.00	0.90	26.26															
13	43.10	35.40	15	39.6	0.057	33.2	0.29	5.74	8.61	0.479	66.00	25.00	0.82	29.61															
14	48.17	36.15	15	41.0	0.057	34.4	0.29	6.18	9.28	0.472	68.40	25.00	0.75	33.09															
15	53.42	36.15	15	43.6	0.057	35.6	0.29	6.63	9.94	0.456	72.60	25.00	0.68	36.70															
3	4.78	4.78	20	13.8	0.076	15.9	0.29	1.33	1.99	-	23.06	33.33	1.00	3.28															
4	7.36	7.36	20	16.2	0.076	18.4	0.29	1.77	2.65	-	26.92	33.33	1.00	5.05															
5	10.28	10.28	20	18.3	0.076	20.6	0.29	2.21	3.31	-	30.52	33.33	1.00	7.06															
6	13.51	13.51	20	20.6	0.076	22.5	0.29	2.65	3.98	0.202	34.25	33.33	1.00	9.28															
7	17.03	16.86	20	23.0	0.076	24.3	0.29	3.09	4.64	0.233	38.31	33.33	0.99	11.70															
8	20.81	20.35	20	26.2	0.076	26.0	0.29	3.53	5.30	0.263	43.58	33.33	0.98	14.29															
9	24.83	24.06	20	29.3	0.076	27.6	0.29	3.98	5.96	0.294	48.77	33.33	0.97	17.06															
10	29.08	28.14	20	31.3	0.076	29.1	0.29	4.42	6.63	0.326	52.23	33.33	0.97	19.98															
11	33.55	32.06	20	34.2	0.076	30.5	0.29	4.86	7.29	0.354	57.02	33.33	0.96	23.05															
12	38.22	36.15	20	36.7	0.076	31.9	0.29	5.30	7.95	0.382	61.21	33.33	0.95	26.26															
13	43.10	40.41	20	39.6	0.076	33.2	0.29	5.74	8.61	0.410	66.00	33.33	0.94	29.61															
14	48.17	45.22	20	41.0	0.076	34.4	0.29	6.18	9.28	0.442	68.40	33.33	0.94	33.09															
15	53.42	48.53	20	43.6	0.076	35.6	0.29	6.63	9.94	0.459	72.60	33.33	0.91	36.70															

Table A.4 Continued

Bar Spacing: $e_2 = 6 \text{ mm}$ Angle of rack inclination: $\theta_1 = 14.477^\circ$														
Measured Parameters							Calculated Parameters							
$y_0 \text{ (cm)}$	$(q_{wh})_T \text{ (lt/(s.m))}$	$(q_{wh})_T \text{ (lt/(s.m))}$	$L \text{ (cm)}$	$L_2 \text{ (cm)}$	$A_{vo} \text{ (m}^2/\text{m)}$	$V_0 \text{ (cm/s)}$	$(F_r)_0$	$y_c \text{ (cm)}$	$H_c = (3/2) y_d \text{ (cm)}$	$C_d \text{ (Eqn 2.5)}$	$L_2/e_2$	$L/e_2$	$(q_{wh})_T / (q_{wh})_T$	$(F_r)_e = ((q_{wh})_T^2 / (e_3 g))^{0.5}$
3	4.78	4.78	25	13.8	0.095	15.9	0.29	1.33	1.99	-	23.06	41.67	1.00	3.28
4	7.36	7.36	25	16.2	0.095	18.4	0.29	1.77	2.65	-	26.92	41.67	1.00	5.05
5	10.28	10.28	25	18.3	0.095	20.6	0.29	2.21	3.31	-	30.52	41.67	1.00	7.06
6	13.51	13.51	25	20.6	0.095	22.5	0.29	2.65	3.98	-	34.25	41.67	1.00	9.28
7	17.03	17.03	25	23.0	0.095	24.3	0.29	3.09	4.64	-	38.31	41.67	1.00	11.70
8	20.81	20.81	25	26.2	0.095	26.0	0.29	3.53	5.30	0.215	43.58	41.67	1.00	14.29
9	24.83	24.56	25	29.3	0.095	27.6	0.29	3.98	5.96	0.240	48.77	41.67	0.99	17.06
10	29.08	28.74	25	31.3	0.095	29.1	0.29	4.42	6.63	0.266	52.23	41.67	0.99	19.98
11	33.55	32.80	25	34.2	0.095	30.5	0.29	4.86	7.29	0.290	57.02	41.67	0.98	23.05
12	38.22	36.92	25	36.7	0.095	31.9	0.29	5.30	7.95	0.312	61.21	41.67	0.97	26.26
13	43.10	41.19	25	39.6	0.095	33.2	0.29	5.74	8.61	0.335	66.00	41.67	0.96	29.61
14	48.17	45.63	25	41.0	0.095	34.4	0.29	6.18	9.28	0.357	68.40	41.67	0.95	33.09
15	53.42	50.21	25	43.6	0.095	35.6	0.29	6.63	9.94	0.380	72.60	41.67	0.94	36.70
3	4.78	4.78	30	13.8	0.114	15.9	0.29	1.33	1.99	-	23.06	50.00	1.00	3.28
4	7.36	7.36	30	16.2	0.114	18.4	0.29	1.77	2.65	-	26.92	50.00	1.00	5.05
5	10.28	10.28	30	18.3	0.114	20.6	0.29	2.21	3.31	-	30.52	50.00	1.00	7.06
6	13.51	13.51	30	20.6	0.114	22.5	0.29	2.65	3.98	-	34.25	50.00	1.00	9.28
7	17.03	17.03	30	23.0	0.114	24.3	0.29	3.09	4.64	-	38.31	50.00	1.00	11.70
8	20.81	20.81	30	26.2	0.114	26.0	0.29	3.53	5.30	-	43.58	50.00	1.00	14.29
9	24.83	24.83	30	29.3	0.114	27.6	0.29	3.98	5.96	-	48.77	50.00	1.00	17.06
10	29.08	29.08	30	31.3	0.114	29.1	0.29	4.42	6.63	0.224	52.23	50.00	1.00	19.98
11	33.55	33.55	30	34.2	0.114	30.5	0.29	4.86	7.29	0.247	57.02	50.00	1.00	23.05
12	38.22	37.68	30	36.7	0.114	31.9	0.29	5.30	7.95	0.265	61.21	50.00	0.99	26.26
13	43.10	42.59	30	39.6	0.114	33.2	0.29	5.74	8.61	0.288	66.00	50.00	0.99	29.61
14	48.17	47.28	30	41.0	0.114	34.4	0.29	6.18	9.28	0.308	68.40	50.00	0.98	33.09
15	53.42	51.91	30	43.6	0.114	35.6	0.29	6.63	9.94	0.327	72.60	50.00	0.97	36.70

Table A.5 Measured and calculated parameters for the experiments conducted with the trash rack of  $e_2$  and  $\theta_2$

		Bar Spacing: $e_2 = 6 \text{ mm}$										Angle of rack inclination: $\theta_2 = 9.594^\circ$									
		Measured Parameters					Calculated Parameters					Measured Parameters					Calculated Parameters				
$V_0 \text{ (cm)}$	$(q_w)_T \text{ (lt/(s.m))}$	$(q_w)_B \text{ (lt/(s.m))}$	$L \text{ (cm)}$	$L_2 \text{ (cm)}$	$A_w \text{ (m}^2\text{/m)}$	$V_0 \text{ (cm/s)}$	$(F_r)_0$	$V_c \text{ (cm)}$	$H_c = (3/2 V_c) \text{ (cm)}$	$C_d \text{ (Eqn 2.5)}$	$L_2/e_2$	$L/e_2$	$(q_w)_T/(q_w)_B$	$(F_r)_e = ((q_w)_T^2/(e_2^3 g))^{0.5}$							
3	4.78	4.57	5	12.9	0.019	15.9	0.29	1.33	1.99	0.386	21.48	8.33	0.96	3.28							
4	7.36	7.03	5	15.8	0.019	18.4	0.29	1.77	2.65	0.515	26.38	8.33	0.96	5.05							
5	10.28	9.83	5	17.5	0.019	20.6	0.29	2.21	3.31	0.644	29.15	8.33	0.96	7.06							
6	13.51	11.86	5	19.4	0.019	22.5	0.29	2.65	3.98	0.709	32.35	8.33	0.88	9.28							
7	17.03	11.86	5	21.9	0.019	24.3	0.29	3.09	4.64	0.656	36.56	8.33	0.70	11.70							
8	20.81	12.38	5	23.9	0.019	26.0	0.29	3.53	5.30	0.641	39.75	8.33	0.60	14.29							
9	24.83	12.12	5	26.0	0.019	27.6	0.29	3.98	5.96	0.592	43.25	8.33	0.49	17.06							
10	29.08	12.38	5	28.9	0.019	29.1	0.29	4.42	6.63	0.573	48.23	8.33	0.43	19.98							
11	33.55	12.65	5	31.3	0.019	30.5	0.29	4.86	7.29	0.558	52.19	8.33	0.38	23.05							
12	38.22	12.92	5	33.0	0.019	31.9	0.29	5.30	7.95	0.546	54.92	8.33	0.34	26.26							
13	43.10	13.19	5	35.3	0.019	33.2	0.29	5.74	8.61	0.536	58.83	8.33	0.31	29.61							
14	48.17	13.73	5	37.3	0.019	34.4	0.29	6.18	9.28	0.537	62.08	8.33	0.29	33.09							
15	53.42	13.73	5	39.2	0.019	35.6	0.29	6.63	9.94	0.519	65.40	8.33	0.26	36.70							
3	4.78	4.78	10	12.9	0.038	15.9	0.29	1.33	1.99	0.202	21.48	16.67	1.00	3.28							
4	7.36	7.36	10	15.8	0.038	18.4	0.29	1.77	2.65	0.269	26.38	16.67	1.00	5.05							
5	10.28	10.28	10	17.5	0.038	20.6	0.29	2.21	3.31	0.337	29.15	16.67	1.00	7.06							
6	13.51	13.46	10	19.4	0.038	22.5	0.29	2.65	3.98	0.402	32.35	16.67	1.00	9.28							
7	17.03	16.86	10	21.9	0.038	24.3	0.29	3.09	4.64	0.467	36.56	16.67	0.99	11.70							
8	20.81	19.58	10	23.9	0.038	26.0	0.29	3.53	5.30	0.507	39.75	16.67	0.94	14.29							
9	24.83	23.40	10	26.0	0.038	27.6	0.29	3.98	5.96	0.571	43.25	16.67	0.94	17.06							
10	29.08	24.39	10	28.9	0.038	29.1	0.29	4.42	6.63	0.565	48.23	16.67	0.84	19.98							
11	33.55	25.40	10	31.3	0.038	30.5	0.29	4.86	7.29	0.561	52.19	16.67	0.76	23.05							
12	38.22	25.73	10	33.0	0.038	31.9	0.29	5.30	7.95	0.544	54.92	16.67	0.67	26.26							
13	43.10	26.41	10	35.3	0.038	33.2	0.29	5.74	8.61	0.536	58.83	16.67	0.61	29.61							
14	48.17	27.10	10	37.3	0.038	34.4	0.29	6.18	9.28	0.530	62.08	16.67	0.56	33.09							
15	53.42	27.79	10	39.2	0.038	35.6	0.29	6.63	9.94	0.525	65.40	16.67	0.52	36.70							

Table A .5 Continued

		Bar Spacing: $e_2 = 6$ mm										Angle of rack inclination: $\theta_2 = 9.594^\circ$									
		Measured Parameters					Calculated Parameters					Measured Parameters					Calculated Parameters				
$V_0$ (cm)	$(q_{wr})$ (lt/(s.m))	$(q_{wh})$ (lt/(s.m))	$L$ (cm)	$L_2$ (cm)	$A_{r0}$ ( $m^2/m$ )	$V_0$ (cm/s)	$(F_r)_0$	$\gamma_c$ (cm)	$H_c = (3/2 \text{ yd (cm)})$	$C_d$ (Eqn 2.5)	$L_2/e_2$	$L/e_2$	$(q_{wh})/(q_{wr})$	$(F_r)_e = ((q_{wh})^2/(e_3 g))^{0.5}$							
3	4.78	4.78	15	12.9	0.057	15.9	0.29	1.33	1.99	-	21.48	25.00	1.00	3.28							
4	7.36	7.36	15	15.8	0.057	18.4	0.29	1.77	2.65	0.180	26.38	25.00	1.00	5.05							
5	10.28	10.28	15	17.5	0.057	20.6	0.29	2.21	3.31	0.224	29.15	25.00	1.00	7.06							
6	13.51	13.51	15	19.4	0.057	22.5	0.29	2.65	3.98	0.269	32.35	25.00	1.00	9.28							
7	17.03	16.86	15	21.9	0.057	24.3	0.29	3.09	4.64	0.311	36.56	25.00	0.99	11.70							
8	20.81	20.51	15	23.9	0.057	26.0	0.29	3.53	5.30	0.354	39.75	25.00	0.99	14.29							
9	24.83	24.06	15	26.0	0.057	27.6	0.29	3.98	5.96	0.391	43.25	25.00	0.97	17.06							
10	29.08	27.79	15	28.9	0.057	29.1	0.29	4.42	6.63	0.429	48.23	25.00	0.96	19.98							
11	33.55	31.88	15	31.3	0.057	30.5	0.29	4.86	7.29	0.469	52.19	25.00	0.95	23.05							
12	38.22	35.78	15	33.0	0.057	31.9	0.29	5.30	7.95	0.504	54.92	25.00	0.94	26.26							
13	43.10	40.01	15	35.3	0.057	33.2	0.29	5.74	8.61	0.542	58.83	25.00	0.93	29.61							
14	48.17	42.39	15	37.3	0.057	34.4	0.29	6.18	9.28	0.553	62.08	25.00	0.88	33.09							
15	53.42	42.79	15	39.2	0.057	35.6	0.29	6.63	9.94	0.539	65.40	25.00	0.80	36.70							
3	4.78	4.78	20	12.9	0.076	15.9	0.29	1.33	1.99	-	21.48	33.33	1.00	3.28							
4	7.36	7.36	20	15.8	0.076	18.4	0.29	1.77	2.65	-	26.38	33.33	1.00	5.05							
5	10.28	10.28	20	17.5	0.076	20.6	0.29	2.21	3.31	-	29.15	33.33	1.00	7.06							
6	13.51	13.51	20	19.4	0.076	22.5	0.29	2.65	3.98	-	32.35	33.33	1.00	9.28							
7	17.03	17.03	20	21.9	0.076	24.3	0.29	3.09	4.64	0.236	36.56	33.33	1.00	11.70							
8	20.81	20.81	20	23.9	0.076	26.0	0.29	3.53	5.30	0.269	39.75	33.33	1.00	14.29							
9	24.83	24.83	20	26.0	0.076	27.6	0.29	3.98	5.96	0.303	43.25	33.33	1.00	17.06							
10	29.08	28.84	20	28.9	0.076	29.1	0.29	4.42	6.63	0.334	48.23	33.33	0.99	19.98							
11	33.55	33.16	20	31.3	0.076	30.5	0.29	4.86	7.29	0.366	52.19	33.33	0.99	23.05							
12	38.22	37.30	20	33.0	0.076	31.9	0.29	5.30	7.95	0.394	54.92	33.33	0.98	26.26							
13	43.10	41.59	20	35.3	0.076	33.2	0.29	5.74	8.61	0.422	58.83	33.33	0.97	29.61							
14	48.17	46.04	20	37.3	0.076	34.4	0.29	6.18	9.28	0.450	62.08	33.33	0.96	33.09							
15	53.42	50.63	20	39.2	0.076	35.6	0.29	6.63	9.94	0.479	65.40	33.33	0.95	36.70							

Table A .5 Continued

Bar Spacing: $e_2 = 6 \text{ mm}$ Angle of rack inclination: $\theta_2 = 9.594^\circ$														
Measured Parameters							Calculated Parameters							
$V_0 \text{ (cm)}$	$(q_{wh})_T \text{ (ft/(s}\cdot\text{m))}$	$(q_{wh})_B \text{ (ft/(s}\cdot\text{m))}$	L (cm)	$L_2$ (cm)	$A_{wo}$ ( $\text{m}^2/\text{m}$ )	$V_0$ (cm/s)	$(F_{\rightarrow})_0$	$v_c$ (cm)	$H_c = (9/2) \gamma d$ (cm)	$C_d$ (Eqn 2.5)	$L_2/e_2$	$L/e_2$	$(q_{wh})_B/(q_{wh})_T$	$(F_{\rightarrow})_e = ((q_{wh})_B^2/(e_3 g))^{0.5}$
3	4.78	4.78	25	12.9	0.095	15.9	0.29	1.33	1.99	-	21.48	41.67	1.00	3.28
4	7.36	7.36	25	15.8	0.095	18.4	0.29	1.77	2.65	-	26.38	41.67	1.00	5.05
5	10.28	10.28	25	17.5	0.095	20.6	0.29	2.21	3.31	-	29.15	41.67	1.00	7.06
6	13.51	13.51	25	19.4	0.095	22.5	0.29	2.65	3.98	-	32.35	41.67	1.00	9.28
7	17.03	17.03	25	21.9	0.095	24.3	0.29	3.09	4.64	-	36.56	41.67	1.00	11.70
8	20.81	20.81	25	23.9	0.095	26.0	0.29	3.53	5.30	-	39.75	41.67	1.00	14.29
9	24.83	24.83	25	26.0	0.095	27.6	0.29	3.98	5.96	0.242	43.25	41.67	1.00	17.06
10	29.08	29.08	25	28.9	0.095	29.1	0.29	4.42	6.63	0.269	48.23	41.67	1.00	19.98
11	33.55	33.55	25	31.3	0.095	30.5	0.29	4.86	7.29	0.296	52.19	41.67	1.00	23.05
12	38.22	37.68	25	33.0	0.095	31.9	0.29	5.30	7.95	0.319	54.92	41.67	0.99	26.26
13	43.10	42.39	25	35.3	0.095	33.2	0.29	5.74	8.61	0.344	58.83	41.67	0.98	29.61
14	48.17	46.86	25	37.3	0.095	34.4	0.29	6.18	9.28	0.367	62.08	41.67	0.97	33.09
15	53.42	51.48	25	39.2	0.095	35.6	0.29	6.63	9.94	0.389	65.40	41.67	0.96	36.70
3	4.78	4.78	30	12.9	0.114	15.9	0.29	1.33	1.99	-	21.48	50.00	1.00	3.28
4	7.36	7.36	30	15.8	0.114	18.4	0.29	1.77	2.65	-	26.38	50.00	1.00	5.05
5	10.28	10.28	30	17.5	0.114	20.6	0.29	2.21	3.31	-	29.15	50.00	1.00	7.06
6	13.51	13.51	30	19.4	0.114	22.5	0.29	2.65	3.98	-	32.35	50.00	1.00	9.28
7	17.03	17.03	30	21.9	0.114	24.3	0.29	3.09	4.64	-	36.56	50.00	1.00	11.70
8	20.81	20.81	30	23.9	0.114	26.0	0.29	3.53	5.30	-	39.75	50.00	1.00	14.29
9	24.83	24.83	30	26.0	0.114	27.6	0.29	3.98	5.96	-	43.25	50.00	1.00	17.06
10	29.08	29.08	30	28.9	0.114	29.1	0.29	4.42	6.63	-	48.23	50.00	1.00	19.98
11	33.55	33.55	30	31.3	0.114	30.5	0.29	4.86	7.29	0.247	52.19	50.00	1.00	23.05
12	38.22	38.22	30	33.0	0.114	31.9	0.29	5.30	7.95	0.269	54.92	50.00	1.00	26.26
13	43.10	43.10	30	35.3	0.114	33.2	0.29	5.74	8.61	0.292	58.83	50.00	1.00	29.61
14	48.17	47.69	30	37.3	0.114	34.4	0.29	6.18	9.28	0.311	62.08	50.00	0.99	33.09
15	53.42	52.77	30	39.2	0.114	35.6	0.29	6.63	9.94	0.333	65.40	50.00	0.99	36.70



Table A .6 Measured and calculated parameters for the experiments conducted with the trash rack of  $e_2$  and  $\theta_3$

		Bar Spacing: $e_2 = 6 \text{ mm}$										Angle of rack inclination: $\theta_3 = 4.780^\circ$									
Measured Parameters												Calculated Parameters									
$y_0 \text{ (cm)}$	$(q_{wt})_T \text{ (lt/(s.m))}$	$(q_{wt})_C \text{ (lt/(s.m))}$	$L \text{ (cm)}$	$L_2 \text{ (cm)}$	$A_w \text{ (m}^2\text{/m)}$	$V_0 \text{ (cm/s)}$	$(F_{T1})_0$	$y_c \text{ (cm)}$	$H_c = (3/2 \gamma d) \text{ (cm)}$	$C_d \text{ (Eqn 2.5)}$	$L_3/e_2$	$L/e_2$	$(q_{wt})_T/(q_{wt})_C$	$(F_{T1})_e = ((q_{wt})_T^2/(e_3^3 g))^{0.5}$							
3	4.78	4.66	5	11.8	0.019	15.9	0.29	1.33	1.99	0.394	19.67	8.33	0.98	3.28							
4	7.36	7.03	5	13.9	0.019	18.4	0.29	1.77	2.65	0.515	23.08	8.33	0.96	5.05							
5	10.28	9.83	5	16.1	0.019	20.6	0.29	2.21	3.31	0.644	26.88	8.33	0.96	7.06							
6	13.51	11.86	5	18.2	0.019	22.5	0.29	2.65	3.98	0.709	30.35	8.33	0.88	9.28							
7	17.03	12.38	5	20.2	0.019	24.3	0.29	3.09	4.64	0.685	33.63	8.33	0.73	11.70							
8	20.81	12.65	5	22.3	0.019	26.0	0.29	3.53	5.30	0.655	37.23	8.33	0.61	14.29							
9	24.83	13.19	5	24.2	0.019	27.6	0.29	3.98	5.96	0.644	40.35	8.33	0.53	17.06							
10	29.08	13.73	5	26.4	0.019	29.1	0.29	4.42	6.63	0.636	43.92	8.33	0.47	19.98							
11	33.55	14.56	5	28.5	0.019	30.5	0.29	4.86	7.29	0.643	47.54	8.33	0.43	23.05							
12	38.22	15.13	5	30.6	0.019	31.9	0.29	5.30	7.95	0.640	51.02	8.33	0.40	26.26							
13	43.10	16.28	5	32.7	0.019	33.2	0.29	5.74	8.61	0.661	54.50	8.33	0.38	29.61							
14	48.17	15.99	5	34.8	0.019	34.4	0.29	6.18	9.28	0.626	57.98	8.33	0.33	33.09							
15	53.42	16.28	5	37.1	0.019	35.6	0.29	6.63	9.94	0.615	61.77	8.33	0.30	36.70							
3	4.78	4.78	10	11.8	0.038	15.9	0.29	1.33	1.99	0.202	19.67	16.67	1.00	3.28							
4	7.36	7.36	10	13.9	0.038	18.4	0.29	1.77	2.65	0.269	23.08	16.67	1.00	5.05							
5	10.28	10.28	10	16.1	0.038	20.6	0.29	2.21	3.31	0.337	26.88	16.67	1.00	7.06							
6	13.51	13.46	10	18.2	0.038	22.5	0.29	2.65	3.98	0.402	30.35	16.67	1.00	9.28							
7	17.03	16.86	10	20.2	0.038	24.3	0.29	3.09	4.64	0.467	33.63	16.67	0.99	11.70							
8	20.81	20.20	10	22.3	0.038	26.0	0.29	3.53	5.30	0.523	37.23	16.67	0.97	14.29							
9	24.83	23.40	10	24.2	0.038	27.6	0.29	3.98	5.96	0.571	40.35	16.67	0.94	17.06							
10	29.08	26.41	10	26.4	0.038	29.1	0.29	4.42	6.63	0.612	43.92	16.67	0.91	19.98							
11	33.55	28.14	10	28.5	0.038	30.5	0.29	4.86	7.29	0.621	47.54	16.67	0.84	23.05							
12	38.22	30.98	10	30.6	0.038	31.9	0.29	5.30	7.95	0.655	51.02	16.67	0.81	26.26							
13	43.10	32.06	10	32.7	0.038	33.2	0.29	5.74	8.61	0.651	54.50	16.67	0.74	29.61							
14	48.17	33.16	10	34.8	0.038	34.4	0.29	6.18	9.28	0.649	57.98	16.67	0.69	33.09							
15	53.42	34.27	10	37.1	0.038	35.6	0.29	6.63	9.94	0.648	61.77	16.67	0.64	36.70							

Table A.6 Continued

Bar Spacing: $e_2 = 6$ mm															Angle of rack inclination: $\theta_3 = 4.780^\circ$														
Measured Parameters															Calculated Parameters														
$y_0$ (cm)	$(q_w)_T$ (lt/(s.m))	$(q_w)_T$ (lt/(s.m))	$(q_w)_T$ (lt/(s.m))	L (cm)	$L_2$ (cm)	$A_{co}$ (m <sup>2</sup> /m)	$V_0$ (cm/s)	$(F_{T0})$	$y_c$ (cm)	$H_c = (3/2 \text{ yd})$ (cm)	$C_d$ (Eqn 2.5)	$L_2/e_2$	$L/e_2$	$(q_w)_T/(q_w)_T$	$(F_{T1})_e = ((q_w)_T)^2/(e_3 g)$ <sup>0.5</sup>														
3	4.78	4.78	4.78	15	11.8	0.057	15.9	0.29	1.33	1.99	-	19.67	25.00	1.00	3.28														
4	7.36	7.36	7.36	15	13.9	0.057	18.4	0.29	1.77	2.65	-	23.08	25.00	1.00	5.05														
5	10.28	10.28	10.28	15	16.1	0.057	20.6	0.29	2.21	3.31	0.224	26.88	25.00	1.00	7.06														
6	13.51	13.51	13.51	15	18.2	0.057	22.5	0.29	2.65	3.98	0.269	30.35	25.00	1.00	9.28														
7	17.03	17.03	17.03	15	20.2	0.057	24.3	0.29	3.09	4.64	0.314	33.63	25.00	1.00	11.70														
8	20.81	20.81	20.81	15	22.3	0.057	26.0	0.29	3.53	5.30	0.359	37.23	25.00	1.00	14.29														
9	24.83	24.83	24.83	15	24.2	0.057	27.6	0.29	3.98	5.96	0.397	40.35	25.00	0.98	17.06														
10	29.08	28.84	28.84	15	26.4	0.057	29.1	0.29	4.42	6.63	0.445	43.92	25.00	0.99	19.98														
11	33.55	33.16	33.16	15	28.5	0.057	30.5	0.29	4.86	7.29	0.488	47.54	25.00	0.99	23.05														
12	38.22	37.30	37.30	15	30.6	0.057	31.9	0.29	5.30	7.95	0.526	51.02	25.00	0.98	26.26														
13	43.10	40.01	40.01	15	32.7	0.057	33.2	0.29	5.74	8.61	0.542	54.50	25.00	0.93	29.61														
14	48.17	42.79	42.79	15	34.8	0.057	34.4	0.29	6.18	9.28	0.558	57.98	25.00	0.89	33.09														
15	53.42	46.04	46.04	15	37.1	0.057	35.6	0.29	6.63	9.94	0.580	61.77	25.00	0.86	36.70														
3	4.78	4.78	4.78	20	11.8	0.076	15.9	0.29	1.33	1.99	-	19.67	33.33	1.00	3.28														
4	7.36	7.36	7.36	20	13.9	0.076	18.4	0.29	1.77	2.65	-	23.08	33.33	1.00	5.05														
5	10.28	10.28	10.28	20	16.1	0.076	20.6	0.29	2.21	3.31	-	26.88	33.33	1.00	7.06														
6	13.51	13.51	13.51	20	18.2	0.076	22.5	0.29	2.65	3.98	-	30.35	33.33	1.00	9.28														
7	17.03	17.03	17.03	20	20.2	0.076	24.3	0.29	3.09	4.64	0.236	33.63	33.33	1.00	11.70														
8	20.81	20.81	20.81	20	22.3	0.076	26.0	0.29	3.53	5.30	0.269	37.23	33.33	1.00	14.29														
9	24.83	24.83	24.83	20	24.2	0.076	27.6	0.29	3.98	5.96	0.303	40.35	33.33	1.00	17.06														
10	29.08	28.67	28.67	20	26.4	0.076	29.1	0.29	4.42	6.63	0.332	43.92	33.33	0.99	19.98														
11	33.55	33.16	33.16	20	28.5	0.076	30.5	0.29	4.86	7.29	0.366	47.54	33.33	0.99	23.05														
12	38.22	37.30	37.30	20	30.6	0.076	31.9	0.29	5.30	7.95	0.394	51.02	33.33	0.98	26.26														
13	43.10	41.59	41.59	20	32.7	0.076	33.2	0.29	5.74	8.61	0.422	54.50	33.33	0.97	29.61														
14	48.17	46.04	46.04	20	34.8	0.076	34.4	0.29	6.18	9.28	0.450	57.98	33.33	0.96	33.09														
15	53.42	50.63	50.63	20	37.1	0.076	35.6	0.29	6.63	9.94	0.479	61.77	33.33	0.95	36.70														

Table A.6 Continued

Bar Spacing: $e_2 = 6 \text{ mm}$ Angle of rack inclination: $\theta_3 = 4.780^\circ$														
Measured Parameters										Calculated Parameters				
$y_0 \text{ (cm)}$	$(q_w)_T \text{ (ft/(s}\cdot\text{m))}$	$(q_w)_T \text{ (ft/(s}\cdot\text{m))}$	$L \text{ (cm)}$	$L_2 \text{ (cm)}$	$A_{co} \text{ (m}^2\text{/m)}$	$V_0 \text{ (cm/s)}$	$(F_r)_0$	$y_c \text{ (cm)}$	$H_c = (3/2 \text{ yd (cm)})$	$C_d \text{ (Eqn 2.5)}$	$L_2/e_2$	$L/e_2$	$(q_w)_T/(q_w)_T$	$(F_r)_e = ((q_w)_T^2/(e_3 \text{ g}))^{0.5}$
3	4.78	4.78	25	11.8	0.095	15.9	0.29	1.33	1.99	-	19.67	41.67	1.00	3.28
4	7.36	7.36	25	13.9	0.095	18.4	0.29	1.77	2.65	-	23.08	41.67	1.00	5.05
5	10.28	10.28	25	16.1	0.095	20.6	0.29	2.21	3.31	-	26.88	41.67	1.00	7.06
6	13.51	13.51	25	18.2	0.095	22.5	0.29	2.65	3.98	-	30.35	41.67	1.00	9.28
7	17.03	17.03	25	20.2	0.095	24.3	0.29	3.09	4.64	-	33.63	41.67	1.00	11.70
8	20.81	20.81	25	22.3	0.095	26.0	0.29	3.53	5.30	-	37.23	41.67	1.00	14.29
9	24.83	24.83	25	24.2	0.095	27.6	0.29	3.98	5.96	-	40.35	41.67	1.00	17.06
10	29.08	29.08	25	26.4	0.095	29.1	0.29	4.42	6.63	0.269	43.92	41.67	1.00	19.98
11	33.55	33.55	25	28.5	0.095	30.5	0.29	4.86	7.29	0.296	47.54	41.67	1.00	23.05
12	38.22	38.22	25	30.6	0.095	31.9	0.29	5.30	7.95	0.323	51.02	41.67	1.00	26.26
13	43.10	42.59	25	32.7	0.095	33.2	0.29	5.74	8.61	0.346	54.50	41.67	0.99	29.61
14	48.17	47.28	25	34.8	0.095	34.4	0.29	6.18	9.28	0.370	57.98	41.67	0.98	33.09
15	53.42	52.34	25	37.1	0.095	35.6	0.29	6.63	9.94	0.396	61.77	41.67	0.98	36.70
3	4.78	4.78	30	11.8	0.114	15.9	0.29	1.33	1.99	-	19.67	50.00	1.00	3.28
4	7.36	7.36	30	13.9	0.114	18.4	0.29	1.77	2.65	-	23.08	50.00	1.00	5.05
5	10.28	10.28	30	16.1	0.114	20.6	0.29	2.21	3.31	-	26.88	50.00	1.00	7.06
6	13.51	13.51	30	18.2	0.114	22.5	0.29	2.65	3.98	-	30.35	50.00	1.00	9.28
7	17.03	17.03	30	20.2	0.114	24.3	0.29	3.09	4.64	-	33.63	50.00	1.00	11.70
8	20.81	20.81	30	22.3	0.114	26.0	0.29	3.53	5.30	-	37.23	50.00	1.00	14.29
9	24.83	24.83	30	24.2	0.114	27.6	0.29	3.98	5.96	-	40.35	50.00	1.00	17.06
10	29.08	29.08	30	26.4	0.114	29.1	0.29	4.42	6.63	-	43.92	50.00	1.00	19.98
11	33.55	33.55	30	28.5	0.114	30.5	0.29	4.86	7.29	-	47.54	50.00	1.00	23.05
12	38.22	38.22	30	30.6	0.114	31.9	0.29	5.30	7.95	0.269	51.02	50.00	1.00	26.26
13	43.10	43.10	30	32.7	0.114	33.2	0.29	5.74	8.61	0.292	54.50	50.00	1.00	29.61
14	48.17	48.17	30	34.8	0.114	34.4	0.29	6.18	9.28	0.314	57.98	50.00	1.00	33.09
15	53.42	52.77	30	37.1	0.114	35.6	0.29	6.63	9.94	0.333	61.77	50.00	0.99	36.70

Table A.7 Measured and calculated parameters for the experiments conducted with the trash rack of  $e_3$  and  $\theta_1$

		Bar Spacing: $e_3 = 10$ mm										Angle of rack inclination: $\theta_1 = 14.477^\circ$									
		Measured Parameters					Calculated Parameters					Measured Parameters					Calculated Parameters				
$y_0$ (cm)	$(q_{wt})$ (lt/(s.m))	$(q_{wh})$ (lt/(s.m))	L (cm)	$L_2$ (cm)	$A_{co}$ ( $m^2/m$ )	$V_0$ (cm/s)	$(F_{lo})$	$y_c$ (cm)	$H_c = (3/2 y_d)$ (cm)	$C_d$ (Eqn 2.5)	$L_2/e_3$	$L/e_3$	$(q_{wh})/(q_{wt})$	$(F_r)_e = ((q_{wt})^2/(e_3 g))^{0.5}$							
3	4.78	4.57	5	13.9	0.025	15.9	0.29	1.33	1.99	0.293	13.94	5.00	0.96	1.53							
4	7.36	7.03	5	16.3	0.025	18.4	0.29	1.77	2.65	0.390	16.25	5.00	0.96	2.35							
5	10.28	9.83	5	18.4	0.025	20.6	0.29	2.21	3.31	0.488	18.41	5.00	0.96	3.28							
6	13.51	11.34	5	20.2	0.025	22.5	0.29	2.65	3.98	0.513	20.15	5.00	0.84	4.31							
7	17.03	11.59	5	22.1	0.025	24.3	0.29	3.09	4.64	0.486	22.13	5.00	0.68	5.44							
8	20.81	11.34	5	23.9	0.025	26.0	0.29	3.53	5.30	0.445	23.85	5.00	0.54	6.64							
9	24.83	11.08	5	25.5	0.025	27.6	0.29	3.98	5.96	0.410	25.54	5.00	0.45	7.93							
10	29.08	11.08	5	27.9	0.025	29.1	0.29	4.42	6.63	0.389	27.88	5.00	0.38	9.28							
11	33.55	10.82	5	29.1	0.025	30.5	0.29	4.86	7.29	0.362	29.10	5.00	0.32	10.71							
12	38.22	11.08	5	31.5	0.025	31.9	0.29	5.30	7.95	0.355	31.45	5.00	0.29	12.20							
13	43.10	11.34	5	33.2	0.025	33.2	0.29	5.74	8.61	0.349	33.16	5.00	0.26	13.76							
14	48.17	11.34	5	34.8	0.025	34.4	0.29	6.18	9.28	0.336	34.81	5.00	0.24	15.38							
15	53.42	11.34	5	36.5	0.025	35.6	0.29	6.63	9.94	0.325	36.51	5.00	0.21	17.06							
3	4.78	4.78	10	13.9	0.050	15.9	0.29	1.33	1.99	0.153	13.94	10.00	1.00	1.53							
4	7.36	7.36	10	16.3	0.050	18.4	0.29	1.77	2.65	0.204	16.25	10.00	1.00	2.35							
5	10.28	10.28	10	18.4	0.050	20.6	0.29	2.21	3.31	0.255	18.41	10.00	1.00	3.28							
6	13.51	13.19	10	20.2	0.050	22.5	0.29	2.65	3.98	0.299	20.15	10.00	0.98	4.31							
7	17.03	16.28	10	22.1	0.050	24.3	0.29	3.09	4.64	0.341	22.13	10.00	0.96	5.44							
8	20.81	19.58	10	23.9	0.050	26.0	0.29	3.53	5.30	0.384	23.85	10.00	0.94	6.64							
9	24.83	22.75	10	25.5	0.050	27.6	0.29	3.98	5.96	0.421	25.54	10.00	0.92	7.93							
10	29.08	24.39	10	27.9	0.050	29.1	0.29	4.42	6.63	0.428	27.88	10.00	0.84	9.28							
11	33.55	24.39	10	29.1	0.050	30.5	0.29	4.86	7.29	0.408	29.10	10.00	0.73	10.71							
12	38.22	24.39	10	31.5	0.050	31.9	0.29	5.30	7.95	0.391	31.45	10.00	0.64	12.20							
13	43.10	24.06	10	33.2	0.050	33.2	0.29	5.74	8.61	0.370	33.16	10.00	0.56	13.76							
14	48.17	23.73	10	34.8	0.050	34.4	0.29	6.18	9.28	0.352	34.81	10.00	0.49	15.38							
15	53.42	23.73	10	36.5	0.050	35.6	0.29	6.63	9.94	0.340	36.51	10.00	0.44	17.06							

Table A.7 Continued

		Bar Spacing: $e_3 = 10$ mm										Angle of rack inclination: $\theta_1 = 14.477^\circ$									
		Measured Parameters					Calculated Parameters					Measured Parameters					Calculated Parameters				
$y_0$ (cm)	$(q_{wh})_T$ (ft/(s.m))	$(q_{wh})_i$ (ft/(s.m))	$L$ (cm)	$L_2$ (cm)	$A_{w0}$ (m <sup>2</sup> /m)	$V_0$ (cm/s)	$(F_{10})_b$	$y_c$ (cm)	$H_c = (3/2 y_0)$ (cm)	$C_d$ (Eqn 2.5)	$L_2/e_3$	$L/e_3$	$(q_{wh})_i/(q_{wh})_T$	$(F_{10})_e = ((q_{wh})_i^2/(e_3 g))^{0.5}$							
3	4.78	4.78	15	13.9	0.075	15.9	0.29	1.33	1.99	-	13.94	15.00	1.00	1.53							
4	7.36	7.36	15	16.3	0.075	18.4	0.29	1.77	2.65	0.136	16.25	15.00	1.00	2.35							
5	10.28	10.28	15	18.4	0.075	20.6	0.29	2.21	3.31	0.170	18.41	15.00	1.00	3.28							
6	13.51	13.51	15	20.2	0.075	22.5	0.29	2.65	3.98	0.204	20.15	15.00	1.00	4.31							
7	17.03	16.86	15	22.1	0.075	24.3	0.29	3.09	4.64	0.236	22.13	15.00	0.99	5.44							
8	20.81	20.51	15	23.9	0.075	26.0	0.29	3.53	5.30	0.268	23.85	15.00	0.99	6.64							
9	24.83	24.06	15	25.5	0.075	27.6	0.29	3.98	5.96	0.297	25.54	15.00	0.97	7.93							
10	29.08	27.45	15	27.9	0.075	29.1	0.29	4.42	6.63	0.321	27.88	15.00	0.94	9.28							
11	33.55	31.34	15	29.1	0.075	30.5	0.29	4.86	7.29	0.349	29.10	15.00	0.93	10.71							
12	38.22	35.02	15	31.5	0.075	31.9	0.29	5.30	7.95	0.374	31.45	15.00	0.92	12.20							
13	43.10	38.84	15	33.2	0.075	33.2	0.29	5.74	8.61	0.398	33.16	15.00	0.90	13.76							
14	48.17	42.39	15	34.8	0.075	34.4	0.29	6.18	9.28	0.419	34.81	15.00	0.88	15.38							
15	53.42	42.79	15	36.5	0.075	35.6	0.29	6.63	9.94	0.409	36.51	15.00	0.80	17.06							
3	4.78	4.78	20	13.9	0.100	15.9	0.29	1.33	1.99	-	13.94	20.00	1.00	1.53							
4	7.36	7.36	20	16.3	0.100	18.4	0.29	1.77	2.65	-	16.25	20.00	1.00	2.35							
5	10.28	10.28	20	18.4	0.100	20.6	0.29	2.21	3.31	-	18.41	20.00	1.00	3.28							
6	13.51	13.51	20	20.2	0.100	22.5	0.29	2.65	3.98	0.153	20.15	20.00	1.00	4.31							
7	17.03	17.03	20	22.1	0.100	24.3	0.29	3.09	4.64	0.179	22.13	20.00	1.00	5.44							
8	20.81	20.81	20	23.9	0.100	26.0	0.29	3.53	5.30	0.204	23.85	20.00	1.00	6.64							
9	24.83	24.56	20	25.5	0.100	27.6	0.29	3.98	5.96	0.227	25.54	20.00	0.99	7.93							
10	29.08	28.84	20	27.9	0.100	29.1	0.29	4.42	6.63	0.253	27.88	20.00	0.99	9.28							
11	33.55	32.80	20	29.1	0.100	30.5	0.29	4.86	7.29	0.274	29.10	20.00	0.98	10.71							
12	38.22	37.11	20	31.5	0.100	31.9	0.29	5.30	7.95	0.297	31.45	20.00	0.97	12.20							
13	43.10	41.19	20	33.2	0.100	33.2	0.29	5.74	8.61	0.317	33.16	20.00	0.96	13.76							
14	48.17	45.63	20	34.8	0.100	34.4	0.29	6.18	9.28	0.338	34.81	20.00	0.95	15.38							
15	53.42	50.21	20	36.5	0.100	35.6	0.29	6.63	9.94	0.360	36.51	20.00	0.94	17.06							

Table A.7 Continued

Bar Spacing: $e_3 = 10$ mm															Angle of rack inclination: $\theta_1 = 14.477^\circ$														
Measured Parameters															Calculated Parameters														
$y_0$ (cm)	$(q_w)_T$ (lt/(s.m))	$(q_w)_T$ (lt/(s.m))	$(q_w)_T$ (ft/(s.m))	$L$ (cm)	$L_2$ (cm)	$A_{no}$ (m <sup>2</sup> /m)	$V_0$ (cm/s)	$(F_1)_0$	$\gamma_c$ (cm)	$H_C = (3/2) \gamma_c$ (cm)	$C_d$ (Eqn 2.5)	$L_2/e_3$	$L/e_3$	$(q_w)_T/(q_w)_T$	$(F_1)_e = ((q_w)_T^2/(e_3 g))^{0.5}$														
3	4.78	4.78	4.78	25	13.9	0.125	15.9	0.29	1.33	1.99	-	13.94	25.00	1.00	1.53														
4	7.36	7.36	7.36	25	16.3	0.125	18.4	0.29	1.77	2.65	-	16.25	25.00	1.00	2.35														
5	10.28	10.28	10.28	25	18.4	0.125	20.6	0.29	2.21	3.31	-	18.41	25.00	1.00	3.28														
6	13.51	13.51	13.51	25	20.2	0.125	22.5	0.29	2.65	3.98	-	20.15	25.00	1.00	4.31														
7	17.03	17.03	17.03	25	22.1	0.125	24.3	0.29	3.09	4.64	-	22.13	25.00	1.00	5.44														
8	20.81	20.81	20.81	25	23.9	0.125	26.0	0.29	3.53	5.30	-	23.85	25.00	1.00	6.64														
9	24.83	24.83	24.83	25	25.5	0.125	27.6	0.29	3.98	5.96	0.184	25.54	25.00	1.00	7.93														
10	29.08	29.08	29.08	25	27.9	0.125	29.1	0.29	4.42	6.63	0.204	27.88	25.00	1.00	9.28														
11	33.55	33.55	33.55	25	29.1	0.125	30.5	0.29	4.86	7.29	0.224	29.10	25.00	1.00	10.71														
12	38.22	38.22	38.22	25	31.5	0.125	31.9	0.29	5.30	7.95	0.242	31.45	25.00	0.99	12.20														
13	43.10	43.10	43.10	25	33.2	0.125	33.2	0.29	5.74	8.61	0.261	33.16	25.00	0.98	13.76														
14	48.17	48.17	48.17	25	34.8	0.125	34.4	0.29	6.18	9.28	0.278	34.81	25.00	0.97	15.38														
15	53.42	53.42	53.42	25	36.5	0.125	35.6	0.29	6.63	9.94	0.297	36.51	25.00	0.97	17.06														
3	4.78	4.78	4.78	30	13.9	0.150	15.9	0.29	1.33	1.99	-	13.94	30.00	1.00	1.53														
4	7.36	7.36	7.36	30	16.3	0.150	18.4	0.29	1.77	2.65	-	16.25	30.00	1.00	2.35														
5	10.28	10.28	10.28	30	18.4	0.150	20.6	0.29	2.21	3.31	-	18.41	30.00	1.00	3.28														
6	13.51	13.51	13.51	30	20.2	0.150	22.5	0.29	2.65	3.98	-	20.15	30.00	1.00	4.31														
7	17.03	17.03	17.03	30	22.1	0.150	24.3	0.29	3.09	4.64	-	22.13	30.00	1.00	5.44														
8	20.81	20.81	20.81	30	23.9	0.150	26.0	0.29	3.53	5.30	-	23.85	30.00	1.00	6.64														
9	24.83	24.83	24.83	30	25.5	0.150	27.6	0.29	3.98	5.96	-	25.54	30.00	1.00	7.93														
10	29.08	29.08	29.08	30	27.9	0.150	29.1	0.29	4.42	6.63	-	27.88	30.00	1.00	9.28														
11	33.55	33.55	33.55	30	29.1	0.150	30.5	0.29	4.86	7.29	-	29.10	30.00	1.00	10.71														
12	38.22	38.22	38.22	30	31.5	0.150	31.9	0.29	5.30	7.95	0.204	31.45	30.00	1.00	12.20														
13	43.10	43.10	43.10	30	33.2	0.150	33.2	0.29	5.74	8.61	0.221	33.16	30.00	1.00	13.76														
14	48.17	48.17	48.17	30	34.8	0.150	34.4	0.29	6.18	9.28	0.236	34.81	30.00	0.99	15.38														
15	53.42	53.42	53.42	30	36.5	0.150	35.6	0.29	6.63	9.94	0.252	36.51	30.00	0.99	17.06														

Table A .8 Measured and calculated parameters for the experiments conducted with the trash rack of  $e_3$  and  $\theta_2$

Bar Spacing: $e_3 = 10$ mm															Angle of rack inclination: $\theta_2 = 9.594^\circ$														
Measured Parameters															Calculated Parameters														
$V_0$ (cm)	$(q_{wT})$ (ft/(s.m))	$(q_{wB})$ (ft/(s.m))	L (cm)	$L_2$ (cm)	$A_{90}$ (m <sup>2</sup> /m)	$V_0$ (cm/s)	$(F_{T0})$	$\gamma_c$ (cm)	$H_c = (3/2 \gamma d)$ (cm)	$C_d$ (Eqn 2.5)	$L_2/e_3$	$L/e_3$	$(q_{wB})/(q_{wT})$	$(F_{T0})_e = ((q_{wT})^2/(e_3 \gamma))^{0.5}$															
3	4.78	4.76	5	8.7	0.025	15.9	0.29	1.33	1.99	0.305	8.70	5.00	1.00	1.53															
4	7.36	7.03	5	11.0	0.025	18.4	0.29	1.77	2.65	0.390	11.01	5.00	0.96	2.35															
5	10.28	9.83	5	13.5	0.025	20.6	0.29	2.21	3.31	0.488	13.45	5.00	0.96	3.28															
6	13.51	11.08	5	15.2	0.025	22.5	0.29	2.65	3.98	0.502	15.24	5.00	0.82	4.31															
7	17.03	11.59	5	16.9	0.025	24.3	0.29	3.09	4.64	0.486	16.85	5.00	0.68	5.44															
8	20.81	12.12	5	18.2	0.025	26.0	0.29	3.53	5.30	0.475	18.19	5.00	0.58	6.64															
9	24.83	12.38	5	20.2	0.025	27.6	0.29	3.98	5.96	0.458	20.16	5.00	0.50	7.93															
10	29.08	12.65	5	21.8	0.025	29.1	0.29	4.42	6.63	0.444	21.81	5.00	0.44	9.28															
11	33.55	13.19	5	23.2	0.025	30.5	0.29	4.86	7.29	0.441	23.19	5.00	0.39	10.71															
12	38.22	13.46	5	25.2	0.025	31.9	0.29	5.30	7.95	0.431	25.15	5.00	0.35	12.20															
13	43.10	13.46	5	26.7	0.025	33.2	0.29	5.74	8.61	0.414	26.69	5.00	0.31	13.76															
14	48.17	13.73	5	28.3	0.025	34.4	0.29	6.18	9.28	0.407	28.25	5.00	0.29	15.38															
15	53.42	14.29	5	29.8	0.025	35.6	0.29	6.63	9.94	0.409	29.75	5.00	0.27	17.06															
3	4.78	4.78	10	8.7	0.050	15.9	0.29	1.33	1.99	-	8.70	10.00	1.00	1.53															
4	7.36	7.36	10	11.0	0.050	18.4	0.29	1.77	2.65	0.204	11.01	10.00	1.00	2.35															
5	10.28	10.28	10	13.5	0.050	20.6	0.29	2.21	3.31	0.255	13.45	10.00	1.00	3.28															
6	13.51	13.46	10	15.2	0.050	22.5	0.29	2.65	3.98	0.305	15.24	10.00	1.00	4.31															
7	17.03	16.57	10	16.9	0.050	24.3	0.29	3.09	4.64	0.347	16.85	10.00	0.97	5.44															
8	20.81	19.89	10	18.2	0.050	26.0	0.29	3.53	5.30	0.390	18.19	10.00	0.96	6.64															
9	24.83	23.73	10	20.2	0.050	27.6	0.29	3.98	5.96	0.439	20.16	10.00	0.96	7.93															
10	29.08	26.41	10	21.8	0.050	29.1	0.29	4.42	6.63	0.463	21.81	10.00	0.91	9.28															
11	33.55	27.79	10	23.2	0.050	30.5	0.29	4.86	7.29	0.465	23.19	10.00	0.83	10.71															
12	38.22	28.49	10	25.2	0.050	31.9	0.29	5.30	7.95	0.456	25.15	10.00	0.75	12.20															
13	43.10	28.84	10	26.7	0.050	33.2	0.29	5.74	8.61	0.444	26.69	10.00	0.67	13.76															
14	48.17	27.79	10	28.3	0.050	34.4	0.29	6.18	9.28	0.412	28.25	10.00	0.58	15.38															
15	53.42	28.49	10	29.8	0.050	35.6	0.29	6.63	9.94	0.408	29.75	10.00	0.53	17.06															

Table A.8 Continued

		Bar Spacing: $e_3 = 10$ mm										Angle of rack inclination: $\theta_2 = 9.594^\circ$									
		Measured Parameters					Calculated Parameters					Measured Parameters					Calculated Parameters				
$y_0$ (cm)	$(q_{wh})_r$ (ft/(s.m))	$(q_{wh})_t$ (ft/(s.m))	L (cm)	L <sub>2</sub> (cm)	A <sub>90</sub> (m <sup>2</sup> /m)	V <sub>0</sub> (cm/s)	(F <sub>r</sub> ) <sub>0</sub>	$y_c$ (cm)	H <sub>c</sub> = (3/2 y <sub>d</sub> ) (cm)	C <sub>d</sub> (Eqn 2.5)	L <sub>2</sub> /e <sub>3</sub>	L/e <sub>3</sub>	$(q_{wh})_t/(q_{wh})_r$	(F <sub>r</sub> ) <sub>c</sub> = $((q_{wh})_t^2/(e_3 g))^{0.5}$							
3	4.78	4.78	15	8.7	0.075	15.9	0.29	1.33	1.99	-	8.70	15.00	1.00	1.53							
4	7.36	7.36	15	11.0	0.075	18.4	0.29	1.77	2.65	-	11.01	15.00	1.00	2.35							
5	10.28	10.28	15	13.5	0.075	20.6	0.29	2.21	3.31	-	13.45	15.00	1.00	3.28							
6	13.51	13.51	15	15.2	0.075	22.5	0.29	2.65	3.98	0.204	15.24	15.00	1.00	4.31							
7	17.03	17.03	15	16.9	0.075	24.3	0.29	3.09	4.64	0.238	16.85	15.00	1.00	5.44							
8	20.81	20.81	15	18.2	0.075	26.0	0.29	3.53	5.30	0.272	18.19	15.00	1.00	6.64							
9	24.83	24.83	15	20.2	0.075	27.6	0.29	3.98	5.96	0.306	20.16	15.00	1.00	7.93							
10	29.08	29.08	15	21.8	0.075	29.1	0.29	4.42	6.63	0.337	21.81	15.00	0.99	9.28							
11	33.55	33.16	15	23.2	0.075	30.5	0.29	4.86	7.29	0.370	23.19	15.00	0.99	10.71							
12	38.22	37.30	15	25.2	0.075	31.9	0.29	5.30	7.95	0.398	25.15	15.00	0.98	12.20							
13	43.10	41.19	15	26.7	0.075	33.2	0.29	5.74	8.61	0.423	26.69	15.00	0.96	13.76							
14	48.17	45.63	15	28.3	0.075	34.4	0.29	6.18	9.28	0.451	28.25	15.00	0.95	15.38							
15	53.42	48.95	15	29.8	0.075	35.6	0.29	6.63	9.94	0.467	29.75	15.00	0.92	17.06							
3	4.78	4.78	20	8.7	0.100	15.9	0.29	1.33	1.99	-	8.70	20.00	1.00	1.53							
4	7.36	7.36	20	11.0	0.100	18.4	0.29	1.77	2.65	-	11.01	20.00	1.00	2.35							
5	10.28	10.28	20	13.5	0.100	20.6	0.29	2.21	3.31	-	13.45	20.00	1.00	3.28							
6	13.51	13.51	20	15.2	0.100	22.5	0.29	2.65	3.98	-	15.24	20.00	1.00	4.31							
7	17.03	17.03	20	16.9	0.100	24.3	0.29	3.09	4.64	-	16.85	20.00	1.00	5.44							
8	20.81	20.81	20	18.2	0.100	26.0	0.29	3.53	5.30	0.204	18.19	20.00	1.00	6.64							
9	24.83	24.83	20	20.2	0.100	27.6	0.29	3.98	5.96	0.230	20.16	20.00	1.00	7.93							
10	29.08	29.08	20	21.8	0.100	29.1	0.29	4.42	6.63	0.255	21.81	20.00	1.00	9.28							
11	33.55	33.55	20	23.2	0.100	30.5	0.29	4.86	7.29	0.281	23.19	20.00	1.00	10.71							
12	38.22	38.07	20	25.2	0.100	31.9	0.29	5.30	7.95	0.305	25.15	20.00	1.00	12.20							
13	43.10	42.79	20	26.7	0.100	33.2	0.29	5.74	8.61	0.329	26.69	20.00	0.99	13.76							
14	48.17	47.28	20	28.3	0.100	34.4	0.29	6.18	9.28	0.350	28.25	20.00	0.98	15.38							
15	53.42	51.91	20	29.8	0.100	35.6	0.29	6.63	9.94	0.372	29.75	20.00	0.97	17.06							



Table A.8 Continued

		Bar Spacing: $e_3 = 10$ mm										Angle of rack inclination: $\theta_2 = 9.594^\circ$									
		Measured Parameters					Calculated Parameters					Measured Parameters					Calculated Parameters				
$y_0$ (cm)	$(q_{wh})$ (ft/(s.m))	$(q_{wh})$ (ft/(s.m))	L (cm)	$L_2$ (cm)	$A_{v0}$ ( $m^2/m$ )	$V_0$ (cm/s)	$(F_{7b})$	$y_c$ (cm)	$H_c = (3/2 y_0)$ (cm)	$C_d$ (Eqn 2.5)	$L_2/e_3$	$L/e_3$	$(q_{wh})/(q_{wh})_T$	$(F_{7c}) = ((q_{wh})^2/(e_3 g))^{0.5}$							
3	4.78	4.78	25	8.7	0.125	15.9	0.29	1.33	1.99	-	8.70	25.00	1.00	1.53							
4	7.36	7.36	25	11.0	0.125	18.4	0.29	1.77	2.65	-	11.01	25.00	1.00	2.35							
5	10.28	10.28	25	13.5	0.125	20.6	0.29	2.21	3.31	-	13.45	25.00	1.00	3.28							
6	13.51	13.51	25	15.2	0.125	22.5	0.29	2.65	3.98	-	15.24	25.00	1.00	4.31							
7	17.03	17.03	25	16.9	0.125	24.3	0.29	3.09	4.64	-	16.85	25.00	1.00	5.44							
8	20.81	20.81	25	18.2	0.125	26.0	0.29	3.53	5.30	-	18.19	25.00	1.00	6.64							
9	24.83	24.83	25	20.2	0.125	27.6	0.29	3.98	5.96	-	20.16	25.00	1.00	7.93							
10	29.08	29.08	25	21.8	0.125	29.1	0.29	4.42	6.63	-	21.81	25.00	1.00	9.28							
11	33.55	33.55	25	23.2	0.125	30.5	0.29	4.86	7.29	-	23.19	25.00	1.00	10.71							
12	38.22	38.22	25	25.2	0.125	31.9	0.29	5.30	7.95	0.245	25.15	25.00	1.00	12.20							
13	43.10	43.10	25	26.7	0.125	33.2	0.29	5.74	8.61	0.265	26.69	25.00	1.00	13.76							
14	48.17	48.17	25	28.3	0.125	34.4	0.29	6.18	9.28	0.286	28.25	25.00	1.00	15.38							
15	53.42	52.77	25	29.8	0.125	35.6	0.29	6.63	9.94	0.302	29.75	25.00	0.99	17.06							
3	4.78	4.78	30	8.7	0.150	15.9	0.29	1.33	1.99	-	8.70	30.00	1.00	1.53							
4	7.36	7.36	30	11.0	0.150	18.4	0.29	1.77	2.65	-	11.01	30.00	1.00	2.35							
5	10.28	10.28	30	13.5	0.150	20.6	0.29	2.21	3.31	-	13.45	30.00	1.00	3.28							
6	13.51	13.51	30	15.2	0.150	22.5	0.29	2.65	3.98	-	15.24	30.00	1.00	4.31							
7	17.03	17.03	30	16.9	0.150	24.3	0.29	3.09	4.64	-	16.85	30.00	1.00	5.44							
8	20.81	20.81	30	18.2	0.150	26.0	0.29	3.53	5.30	-	18.19	30.00	1.00	6.64							
9	24.83	24.83	30	20.2	0.150	27.6	0.29	3.98	5.96	-	20.16	30.00	1.00	7.93							
10	29.08	29.08	30	21.8	0.150	29.1	0.29	4.42	6.63	-	21.81	30.00	1.00	9.28							
11	33.55	33.55	30	23.2	0.150	30.5	0.29	4.86	7.29	-	23.19	30.00	1.00	10.71							
12	38.22	38.22	30	25.2	0.150	31.9	0.29	5.30	7.95	-	25.15	30.00	1.00	12.20							
13	43.10	43.10	30	26.7	0.150	33.2	0.29	5.74	8.61	-	26.69	30.00	1.00	13.76							
14	48.17	48.17	30	28.3	0.150	34.4	0.29	6.18	9.28	-	28.25	30.00	1.00	15.38							
15	53.42	53.42	30	29.8	0.150	35.6	0.29	6.63	9.94	-	29.75	30.00	1.00	17.06							

Table A .9 Measured and calculated parameters for the experiments conducted with the trash rack of  $e_3$  and  $\theta_3$

Bar Spacing: $e_3 = 10$ mm															Angle of rack inclination: $\theta_3 = 4.780^\circ$														
Measured Parameters															Calculated Parameters														
$\gamma_0$ (cm)	$(q_{wh})_1$ (lt/(s.m))	$(q_{wh})_2$ (lt/(s.m))	$(q_{wh})_3$ (lt/(s.m))	L (cm)	$L_2$ (cm)	$A_{100}$ (m <sup>2</sup> /m)	$V_0$ (cm/s)	$(F_{1,0})$	$\gamma_c$ (cm)	$H_c = (3/2 \gamma_0)$ (cm)	$C_d$ (Eqn 2.5)	$L_2/e_3$	$L/e_3$	$(q_{wh})_i/(q_{wh})_1$	$(F_i)_c = ((q_{wh})_i^2/(e_3 \cdot g))^{0.5}$														
3	4.78	4.78	4.78	5	7.6	0.025	15.9	0.29	1.33	1.99	0.306	7.59	5.00	1.00	1.53														
4	7.36	7.25	7.25	5	10.4	0.025	18.4	0.29	1.77	2.65	0.402	10.43	5.00	0.99	2.35														
5	10.28	9.83	9.83	5	12.6	0.025	20.6	0.29	2.21	3.31	0.488	12.58	5.00	0.96	3.28														
6	13.51	12.38	12.38	5	13.8	0.025	22.5	0.29	2.65	3.98	0.561	13.75	5.00	0.92	4.31														
7	17.03	13.19	13.19	5	15.6	0.025	24.3	0.29	3.09	4.64	0.553	15.56	5.00	0.77	5.44														
8	20.81	13.73	13.73	5	17.2	0.025	26.0	0.29	3.53	5.30	0.539	17.21	5.00	0.66	6.64														
9	24.83	13.73	13.73	5	18.6	0.025	27.6	0.29	3.98	5.96	0.508	18.59	5.00	0.55	7.93														
10	29.08	14.56	14.56	5	19.8	0.025	29.1	0.29	4.42	6.63	0.511	19.84	5.00	0.50	9.28														
11	33.55	14.85	14.85	5	21.3	0.025	30.5	0.29	4.86	7.29	0.497	21.33	5.00	0.44	10.71														
12	38.22	14.85	14.85	5	22.7	0.025	31.9	0.29	5.30	7.95	0.475	22.66	5.00	0.39	12.20														
13	43.10	15.41	15.41	5	24.0	0.025	33.2	0.29	5.74	8.61	0.474	24.04	5.00	0.36	13.76														
14	48.17	15.99	15.99	5	25.4	0.025	34.4	0.29	6.18	9.28	0.474	25.43	5.00	0.33	15.38														
15	53.42	16.57	16.57	5	26.8	0.025	35.6	0.29	6.63	9.94	0.475	26.79	5.00	0.31	17.06														
3	4.78	4.78	4.78	10	7.6	0.050	15.9	0.29	1.33	1.99	-	7.59	10.00	1.00	1.53														
4	7.36	7.36	7.36	10	10.4	0.050	18.4	0.29	1.77	2.65	0.204	10.43	10.00	1.00	2.35														
5	10.28	10.28	10.28	10	12.6	0.050	20.6	0.29	2.21	3.31	0.255	12.58	10.00	1.00	3.28														
6	13.51	13.46	13.46	10	13.8	0.050	22.5	0.29	2.65	3.98	0.305	13.75	10.00	1.00	4.31														
7	17.03	16.57	16.57	10	15.6	0.050	24.3	0.29	3.09	4.64	0.347	15.56	10.00	0.97	5.44														
8	20.81	20.20	20.20	10	17.2	0.050	26.0	0.29	3.53	5.30	0.396	17.21	10.00	0.97	6.64														
9	24.83	24.06	24.06	10	18.6	0.050	27.6	0.29	3.98	5.96	0.445	18.59	10.00	0.97	7.93														
10	29.08	27.10	27.10	10	19.8	0.050	29.1	0.29	4.42	6.63	0.475	19.84	10.00	0.93	9.28														
11	33.55	30.62	30.62	10	21.3	0.050	30.5	0.29	4.86	7.29	0.512	21.33	10.00	0.91	10.71														
12	38.22	31.70	31.70	10	22.7	0.050	31.9	0.29	5.30	7.95	0.508	22.66	10.00	0.83	12.20														
13	43.10	32.06	32.06	10	24.0	0.050	33.2	0.29	5.74	8.61	0.493	24.04	10.00	0.74	13.76														
14	48.17	32.43	32.43	10	25.4	0.050	34.4	0.29	6.18	9.28	0.481	25.43	10.00	0.67	15.38														
15	53.42	32.80	32.80	10	26.8	0.050	35.6	0.29	6.63	9.94	0.470	26.79	10.00	0.61	17.06														

Table A.9 Continued

Bar Spacing: $e_3 = 10$ mm															Angle of rack inclination: $\theta_3 = 4.780^\circ$														
Measured Parameters															Calculated Parameters														
$y_0$ (cm)	$(q_{wt})_i$ (ft/(s.m))	$(q_{wt})_i$ (ft/(s.m))	$L$ (cm)	$L_2$ (cm)	$A_{90}$ (m <sup>2</sup> /m)	$V_0$ (cm/s)	$ F_{r,lo} $	$y_c$ (cm)	$H_c = (9/2 y_0)$ (cm)	$C_d$ (Eqn 2.5)	$L_2/e_3$	$L/e_3$	$(q_{wt})_i/(q_{wt})_T$	$(F_{r,e}) = ((q_{wt})_T^2/(e_3 g))^{0.5}$															
3	4.78	4.78	15	7.6	0.075	15.9	0.29	1.33	1.99	-	7.59	15.00	1.00	1.53															
4	7.36	7.36	15	10.4	0.075	18.4	0.29	1.77	2.65	-	10.43	15.00	1.00	2.35															
5	10.28	10.28	15	12.6	0.075	20.6	0.29	2.21	3.31	-	12.58	15.00	1.00	3.28															
6	13.51	13.51	15	13.8	0.075	22.5	0.29	2.65	3.98	-	13.75	15.00	1.00	4.31															
7	17.03	17.03	15	15.6	0.075	24.3	0.29	3.09	4.64	0.238	15.56	15.00	1.00	5.44															
8	20.81	20.81	15	17.2	0.075	26.0	0.29	3.53	5.30	0.272	17.21	15.00	1.00	6.64															
9	24.83	24.83	15	18.6	0.075	27.6	0.29	3.98	5.96	0.306	18.59	15.00	1.00	7.93															
10	29.08	28.84	15	19.8	0.075	29.1	0.29	4.42	6.63	0.337	19.84	15.00	0.99	9.28															
11	33.55	33.16	15	21.3	0.075	30.5	0.29	4.86	7.29	0.370	21.33	15.00	0.99	10.71															
12	38.22	37.68	15	22.7	0.075	31.9	0.29	5.30	7.95	0.402	22.66	15.00	0.99	12.20															
13	43.10	41.99	15	24.0	0.075	33.2	0.29	5.74	8.61	0.431	24.04	15.00	0.97	13.76															
14	48.17	46.45	15	25.4	0.075	34.4	0.29	6.18	9.28	0.459	25.43	15.00	0.96	15.38															
15	53.42	51.06	15	26.8	0.075	35.6	0.29	6.63	9.94	0.488	26.79	15.00	0.96	17.06															
3	4.78	4.78	20	7.6	0.100	15.9	0.29	1.33	1.99	-	7.59	20.00	1.00	1.53															
4	7.36	7.36	20	10.4	0.100	18.4	0.29	1.77	2.65	-	10.43	20.00	1.00	2.35															
5	10.28	10.28	20	12.6	0.100	20.6	0.29	2.21	3.31	-	12.58	20.00	1.00	3.28															
6	13.51	13.51	20	13.8	0.100	22.5	0.29	2.65	3.98	-	13.75	20.00	1.00	4.31															
7	17.03	17.03	20	15.6	0.100	24.3	0.29	3.09	4.64	-	15.56	20.00	1.00	5.44															
8	20.81	20.81	20	17.2	0.100	26.0	0.29	3.53	5.30	-	17.21	20.00	1.00	6.64															
9	24.83	24.83	20	18.6	0.100	27.6	0.29	3.98	5.96	-	18.59	20.00	1.00	7.93															
10	29.08	29.08	20	19.8	0.100	29.1	0.29	4.42	6.63	0.255	19.84	20.00	1.00	9.28															
11	33.55	33.55	20	21.3	0.100	30.5	0.29	4.86	7.29	0.281	21.33	20.00	1.00	10.71															
12	38.22	38.22	20	22.7	0.100	31.9	0.29	5.30	7.95	0.306	22.66	20.00	1.00	12.20															
13	43.10	43.10	20	24.0	0.100	33.2	0.29	5.74	8.61	0.332	24.04	20.00	1.00	13.76															
14	48.17	47.90	20	25.4	0.100	34.4	0.29	6.18	9.28	0.355	25.43	20.00	0.99	15.38															
15	53.42	52.77	20	26.8	0.100	35.6	0.29	6.63	9.94	0.378	26.79	20.00	0.99	17.06															

Table A.9 Continued

Bar Spacing: $e_3 = 10$ mm      Angle of rack inclination: $\theta_3 = 4.780^\circ$														
Measured Parameters							Calculated Parameters							
$y_0$ (cm)	$(q_w)_h$ (lt/(s.m))	$(q_w)_i$ (lt/(s.m))	L (cm)	$L_2$ (cm)	$A_{90}$ (m <sup>2</sup> /m)	$V_0$ (cm/s)	$(F_{10})$	$y_c$ (cm)	$H_C = (3/2 y_c)$ (cm)	$C_d$ (Eqn 2.5)	$L_2/e_3$	$L/e_3$	$(q_w)_i/(q_w)_h$	$(F_{10})_e = ((q_w)_i^2/(e_3 g))^{0.5}$
3	4.78	4.78	25	7.6	0.125	15.9	0.29	1.33	1.99	-	7.59	25.00	1.00	1.53
4	7.36	7.36	25	10.4	0.125	18.4	0.29	1.77	2.65	-	10.43	25.00	1.00	2.35
5	10.28	10.28	25	12.6	0.125	20.6	0.29	2.21	3.31	-	12.58	25.00	1.00	3.28
6	13.51	13.51	25	13.8	0.125	22.5	0.29	2.65	3.98	-	13.75	25.00	1.00	4.31
7	17.03	17.03	25	15.6	0.125	24.3	0.29	3.09	4.64	-	15.56	25.00	1.00	5.44
8	20.81	20.81	25	17.2	0.125	26.0	0.29	3.53	5.30	-	17.21	25.00	1.00	6.64
9	24.83	24.83	25	18.6	0.125	27.6	0.29	3.98	5.96	-	18.59	25.00	1.00	7.93
10	29.08	29.08	25	19.8	0.125	29.1	0.29	4.42	6.63	-	19.84	25.00	1.00	9.28
11	33.55	33.55	25	21.3	0.125	30.5	0.29	4.86	7.29	-	21.33	25.00	1.00	10.71
12	38.22	38.22	25	22.7	0.125	31.9	0.29	5.30	7.95	-	22.66	25.00	1.00	12.20
13	43.10	43.10	25	24.0	0.125	33.2	0.29	5.74	8.61	-	24.04	25.00	1.00	13.76
14	48.17	48.17	25	25.4	0.125	34.4	0.29	6.18	9.28	0.286	25.43	25.00	1.00	15.38
15	53.42	53.42	25	26.8	0.125	35.6	0.29	6.63	9.94	0.306	26.79	25.00	1.00	17.06
3	4.78	4.78	30	7.6	0.150	15.9	0.29	1.33	1.99	-	7.59	30.00	1.00	1.53
4	7.36	7.36	30	10.4	0.150	18.4	0.29	1.77	2.65	-	10.43	30.00	1.00	2.35
5	10.28	10.28	30	12.6	0.150	20.6	0.29	2.21	3.31	-	12.58	30.00	1.00	3.28
6	13.51	13.51	30	13.8	0.150	22.5	0.29	2.65	3.98	-	13.75	30.00	1.00	4.31
7	17.03	17.03	30	15.6	0.150	24.3	0.29	3.09	4.64	-	15.56	30.00	1.00	5.44
8	20.81	20.81	30	17.2	0.150	26.0	0.29	3.53	5.30	-	17.21	30.00	1.00	6.64
9	24.83	24.83	30	18.6	0.150	27.6	0.29	3.98	5.96	-	18.59	30.00	1.00	7.93
10	29.08	29.08	30	19.8	0.150	29.1	0.29	4.42	6.63	-	19.84	30.00	1.00	9.28
11	33.55	33.55	30	21.3	0.150	30.5	0.29	4.86	7.29	-	21.33	30.00	1.00	10.71
12	38.22	38.22	30	22.7	0.150	31.9	0.29	5.30	7.95	-	22.66	30.00	1.00	12.20
13	43.10	43.10	30	24.0	0.150	33.2	0.29	5.74	8.61	-	24.04	30.00	1.00	13.76
14	48.17	48.17	30	25.4	0.150	34.4	0.29	6.18	9.28	-	25.43	30.00	1.00	15.38
15	53.42	53.42	30	26.8	0.150	35.6	0.29	6.63	9.94	-	26.79	30.00	1.00	17.06

## **APPENDIX B**

### **MEASURED PARAMETERS OF THE EXPERIMENTS CONDUCTED WITH SEDIMENT AND WATER**

Table B.1 Measured parameters of the experiment no: 1 conducted with sediment on trash rack of ( $e_1$ ,  $\theta_1$  and  $L_a$ )

<b><math>e_1/a_1 = 0.23</math>, <math>L_a = 20</math> cm, <math>\theta_1 = 14.477^\circ</math>, <math>(q_s)_T = 150</math> kgf</b>					
<b>Measured Time, t (second)</b>	<b><math>(q_w)_T</math> (lt/(s.m))</b>	<b><math>(q_w)_i</math> (lt/(s.m))</b>	<b><math>(q_w)_i/(q_w)_T</math></b>	<b><math>(q_s)_i</math> (kgf)</b>	<b><math>(q_s)_i/(q_s)_T</math></b>
22	9.19				
105	9.19				
207	12.02	12.01	1.00		
294	16.26	16.15	0.99		
396	21.91	21.43	0.98		
494	29.69	28.29	0.95		
604	36.05	29.95	0.83		
708	45.24	31.65	0.70		
789	52.31	31.65	0.61		
893	57.96	31.65	0.55		
1003	67.15	31.65	0.47		
1114	74.22	32.81	0.44		
1205	82.00	33.39	0.41		
1388	91.18	34.56	0.38		
1490	100.37	35.15	0.35		
1604	106.03	35.74	0.34		
1713	111.68	35.74	0.32		
1816	118.05	36.94	0.31		
1925	120.87	36.94	0.31	36	0.24

Table B.2 Measured parameters of the experiment no: 2 conducted with sediment on trash rack of ( $e_1$ ,  $\theta_1$  and  $L_a$ )

<b><math>e_1/a_1 = 0.23</math>, <math>L_a = 20</math> cm, <math>\theta_1 = 14.477^\circ</math>, <math>(q_s)_T = 150</math> kgf</b>					
<b>Measured Time, t (second)</b>	<b><math>(q_w)_T</math> (lt/(s.m))</b>	<b><math>(q_w)_i</math> (lt/(s.m))</b>	<b><math>(q_w)_i/(q_w)_T</math></b>	<b><math>(q_s)_i</math> (kgf)</b>	<b><math>(q_s)_i/(q_s)_T</math></b>
0	9.9	9.42	0.95		
260	29.7	28.29	0.95		
503	50.2	35.74	0.71		
754	70.0	39.99	0.57		
1014	89.8	42.49	0.47		
1221	110.3	44.40	0.40		
1468	130.1	45.69	0.35	36	0.24

Table B.3 Measured parameters of the experiment no: 1 conducted with sediment on trash rack of ( $e_1$ ,  $\theta_1$  and  $L_b$ )

<b><math>e_1/a_1 = 0.23</math>, <math>L_b = 40</math> cm, <math>\theta_1 = 14.477^\circ</math>, <math>(q_s)_T = 150</math> kgf</b>					
<b>Measured Time, t (second)</b>	<b><math>(q_w)_T</math> (lt/(s.m))</b>	<b><math>(q_w)_i</math> (lt/(s.m))</b>	<b><math>(q_w)_i/(q_w)_T</math></b>	<b><math>(q_s)_i</math> (kgf)</b>	<b><math>(q_s)_i/(q_s)_T</math></b>
9	9.90				
107	14.84				
218	19.09	18.97	0.99		
343	24.74	24.52	0.99		
467	29.69	28.84	0.97		
597	37.46	35.74	0.95		
701	42.41	38.15	0.90		
795	50.89	45.04	0.88		
942	62.20	49.62	0.80		
1046	71.39	53.66	0.75		
1185	82.70	57.80	0.70		
1296	92.60	61.33	0.66		
1396	99.67	63.49	0.64		
1513	104.62	64.94	0.62		
1622	115.92	67.13	0.58		
1746	122.29	70.09	0.57		
1937	124.41	69.34	0.56	52	0.35

Table B.4 Measured parameters of the experiment no: 2 conducted with sediment on trash rack of ( $e_1$ ,  $\theta_1$  and  $L_b$ )

<b><math>e_1/a_1 = 0.23</math>, <math>L_b = 40</math> cm, <math>\theta_1 = 14.477^\circ</math>, <math>(q_s)_T = 150</math> kgf</b>					
<b>Measured Time, t (second)</b>	<b><math>(q_w)_T</math> (lt/(s.m))</b>	<b><math>(q_w)_i</math> (lt/(s.m))</b>	<b><math>(q_w)_i/(q_w)_T</math></b>	<b><math>(q_s)_i</math> (kgf)</b>	<b><math>(q_s)_i/(q_s)_T</math></b>
0	9.9	9.42	0.95		
273	29.7	29.39	0.99		
507	50.2	46.33	0.92		
747	70.0	57.80	0.83		
967	89.8	61.33	0.68		
1226	110.3	68.60	0.62		
1471	130.1	75.37	0.58	51	0.34

Table B.5 Measured parameters of the experiment no: 1 conducted with sediment on trash rack of ( $e_1$ ,  $\theta_1$  and  $L_c$ )

$e_1/a_1 = 0.23$ , $L_c = 60$ cm, $\theta_1 = 14.477^\circ$ , $(q_s)_T = 150$ kgf					
Measured Time, t (second)	$(q_w)_T$ (lt/(s.m))	$(q_w)_i$ (lt/(s.m))	$(q_w)_i/(q_w)_T$	$(q_s)_i$ (kgf)	$(q_s)_i/(q_s)_T$
3	9.19				
223	12.02	11.80	0.98		
439	19.09	18.68	0.98		
620	29.69	28.84	0.97		
761	42.41	40.61	0.96		
939	53.01	50.29	0.95		
1065	61.50	57.80	0.94		
1223	74.93	67.13	0.90		
1360	87.65	76.14	0.87		
1500	98.25	81.57	0.83		
1656	106.03	85.52	0.81		
1820	115.22	89.53	0.78	63	0.42

Table B.6 Measured parameters of the experiment no: 2 conducted with sediment on trash rack of ( $e_1$ ,  $\theta_1$  and  $L_c$ )

$e_1/a_1 = 0.23$ , $L_c = 60$ cm, $\theta_1 = 14.477^\circ$ , $(q_s)_T = 150$ kgf					
Measured Time, t (second)	$(q_w)_T$ (lt/(s.m))	$(q_w)_i$ (lt/(s.m))	$(q_w)_i/(q_w)_T$	$(q_s)_i$ (kgf)	$(q_s)_i/(q_s)_T$
0	9.90	9.81	0.99		
268	29.69	29.12	0.98		
514	50.19	48.30	0.96		
769	69.98	62.77	0.90		
1001	89.77	78.45	0.87		
1233	110.27	91.16	0.83		
1477	130.06	97.74	0.75	58	0.39



Table B.7 Measured parameters of the experiment no: 1 conducted with sediment on trash rack of ( $e_1$ ,  $\theta_2$  and  $L_a$ )

$e_1/a_1 = 0.23$ , $L_a = 20$ cm, $\theta_2 = 9.594^\circ$ , $(q_s)_T = 150$ kgf					
Measured Time, t (second)	$(q_w)_T$ (lt/(s.m))	$(q_w)_i$ (lt/(s.m))	$(q_w)_i/(q_w)_T$	$(q_s)_i$ (kgf)	$(q_s)_i/(q_s)_T$
24	9.19				
169	14.14	14.18	1.00		
330	24.74	24.52	0.99		
450	33.22	28.84	0.87		
557	42.41	31.08	0.73		
725	50.19	29.95	0.60		
857	58.67	31.65	0.54		
972	66.44	32.81	0.49		
1115	73.51	33.39	0.45		
1238	80.58	33.39	0.41		
1423	89.06	34.56	0.39		
1606	94.72	35.15	0.37		
1783	101.08	35.74	0.35		
1923	106.03	36.34	0.34		
2046	110.98	36.94	0.33	44	0.29

Table B.8 Measured parameters of the experiment no: 2 conducted with sediment on trash rack of ( $e_1$ ,  $\theta_2$  and  $L_a$ )

$e_1/a_1 = 0.23$ , $L_a = 20$ cm, $\theta_2 = 9.594^\circ$ , $(q_s)_T = 150$ kgf					
Measured Time, t (second)	$(q_w)_T$ (lt/(s.m))	$(q_w)_i$ (lt/(s.m))	$(q_w)_i/(q_w)_T$	$(q_s)_i$ (kgf)	$(q_s)_i/(q_s)_T$
0	9.90	9.81	0.99		
277	29.69	28.29	0.95		
495	50.19	36.34	0.72		
752	69.98	41.86	0.60		
979	89.77	44.40	0.49		
1248	110.27	46.98	0.43		
1464	130.06	48.96	0.38	42	0.28

Table B.9 Measured parameters of the experiment no: 1 conducted with sediment on trash rack of ( $e_1$ ,  $\theta_2$  and  $L_b$ )

$e_1/a_1 = 0.23$ , $L_b = 40$ cm, $\theta_2 = 9.594^\circ$ , $(q_s)_T = 150$ kgf					
Measured Time, t (second)	$(q_w)_T$ (lt/(s.m))	$(q_w)_i$ (lt/(s.m))	$(q_w)_i/(q_w)_T$	$(q_s)_i$ (kgf)	$(q_s)_i/(q_s)_T$
11	9.19				
208	16.96	16.61	0.98		
356	29.69	28.29	0.95		
499	41.00	38.15	0.93		
672	57.96	51.63	0.89		
808	75.63	58.50	0.77		
1072	86.94	63.49	0.73		
1192	98.25	67.13	0.68		
1322	110.27	71.59	0.65		
1514	118.75	73.85	0.62		
1650	126.53	76.91	0.61		
1791	130.77	77.68	0.59	52.00	0.35

Table B.10 Measured parameters of the experiment no: 2 conducted with sediment on trash rack of ( $e_1$ ,  $\theta_2$  and  $L_b$ )

$e_1/a_1 = 0.23$ , $L_b = 40$ cm, $\theta_2 = 9.594^\circ$ , $(q_s)_T = 150$ kgf					
Measured Time, t (second)	$(q_w)_T$ (lt/(s.m))	$(q_w)_i$ (lt/(s.m))	$(q_w)_i/(q_w)_T$	$(q_s)_i$ (kgf)	$(q_s)_i/(q_s)_T$
0	9.90	9.81	0.99		
282	29.69	28.84	0.97		
505	50.19	48.30	0.96		
747	69.98	57.11	0.82		
982	89.77	64.21	0.72		
1221	110.27	70.84	0.64		
1465	130.06	75.37	0.58	58.00	0.39

Table B.11 Measured parameters of the experiment no: 1 conducted with sediment on trash rack of ( $e_1$ ,  $\theta_2$  and  $L_c$ )

$e_1/a_1 = 0.23$ , $L_c = 60$ cm, $\theta_2 = 9.594^\circ$ , $(q_s)_T = 150$ kgf					
Measured Time, t (second)	$(q_w)_T$ (lt/(s.m))	$(q_w)_i$ (lt/(s.m))	$(q_w)_i/(q_w)_T$	$(q_s)_i$ (kgf)	$(q_s)_i/(q_s)_T$
31	9.19				
236	19.79	19.80	1.00		
398	32.52	32.52	1.00		
587	50.19	50.29	1.00		
756	68.57	65.66	0.96		
932	92.60	82.35	0.89		
1063	109.56	91.16	0.83		
1194	120.87	96.08	0.79		
1340	132.18	101.10	0.76		
1459	137.84	103.63	0.75		
1558	146.32	103.63	0.71	63.31	0.42

Table B.12 Measured parameters of the experiment no: 2 conducted with sediment on trash rack of ( $e_1$ ,  $\theta_2$  and  $L_c$ )

$e_1/a_1 = 0.23$ , $L_c = 60$ cm, $\theta_2 = 9.594^\circ$ , $(q_s)_T = 150$ kgf					
Measured Time, t (second)	$(q_w)_T$ (lt/(s.m))	$(q_w)_i$ (lt/(s.m))	$(q_w)_i/(q_w)_T$	$(q_s)_i$ (kgf)	$(q_s)_i/(q_s)_T$
77	11.31				
133	25.45	25.36	1.00		
288	38.17	38.15	1.00		
434	51.60	51.29	0.99		
571	69.98	65.66	0.94		
783	87.65	78.45	0.90		
894	104.62	87.92	0.84		
1012	115.92	90.34	0.78		
1114	127.23	101.10	0.79		
1268	132.89	99.42	0.75		
1381	137.84	100.25	0.73	62	0.41

Table B.13 Measured parameters of the experiment no: 1 conducted with sediment on trash rack of ( $e_1$ ,  $\theta_3$  and  $L_a$ )

$e_1/a_1 = 0.23, L_a = 20 \text{ cm}, \theta_3 = 4.780^\circ, (q_s)_T = 150 \text{ kgf}$					
Measured Time, t (second)	$(q_w)_T$ (lt/(s.m))	$(q_w)_i$ (lt/(s.m))	$(q_w)_i/(q_w)_T$	$(q_s)_i$ (kgf)	$(q_s)_i/(q_s)_T$
30	8.48				
154	17.67	17.08	0.97		
383	31.81	29.95	0.94		
591	48.77	35.15	0.72		
804	64.32	35.74	0.56		
942	77.05	36.34	0.47		
1111	92.60	38.15	0.41		
1250	106.03	40.61	0.38		
1391	116.63	41.24	0.35		
1528	127.23	42.49	0.33		
1636	136.42	44.40	0.33	44.00	0.29

Table B.14 Measured parameters of the experiment no: 2 conducted with sediment on trash rack of ( $e_1$ ,  $\theta_3$  and  $L_a$ )

$e_1/a_1 = 0.23, L_a = 20 \text{ cm}, \theta_3 = 4.780^\circ, (q_s)_T = 150 \text{ kgf}$					
Measured Time, t (second)	$(q_w)_T$ (lt/(s.m))	$(q_w)_i$ (lt/(s.m))	$(q_w)_i/(q_w)_T$	$(q_s)_i$ (kgf)	$(q_s)_i/(q_s)_T$
0	9.90	9.81	0.99		
266	29.69	28.84	0.97		
502	50.19	36.34	0.72		
750	69.98	40.61	0.58		
987	89.77	45.04	0.50		
1219	110.27	48.96	0.44		
1464	130.06	51.63	0.40	44.00	0.29

Table B.15 Measured parameters of the experiment no: 1 conducted with sediment on trash rack of ( $e_1$ ,  $\theta_3$  and  $L_b$ )

$e_1/a_1 = 0.23$ , $L_b = 40$ cm, $\theta_3 = 4.780^\circ$ , $(q_s)_T = 150$ kgf					
Measured Time, t (second)	$(q_w)_T$ (lt/(s.m))	$(q_w)_i$ (lt/(s.m))	$(q_w)_i/(q_w)_T$	$(q_s)_i$ (kgf)	$(q_s)_i/(q_s)_T$
30	8.48				
93	9.90				
173	15.55	15.47	0.99		
311	24.03	23.47	0.98		
409	36.05	35.15	0.98		
591	48.77	42.49	0.87		
776	57.26	48.96	0.86		
951	68.57	55.72	0.81		
1116	80.58	59.91	0.74		
1245	93.31	64.21	0.69		
1383	101.79	65.66	0.65		
1504	113.80	70.09	0.62		
1618	122.99	73.09	0.59		
1779	128.65	73.09	0.57	60	0.40

Table B.16 Measured parameters of the experiment no: 2 conducted with sediment on trash rack of ( $e_1$ ,  $\theta_3$  and  $L_b$ )

$e_1/a_1 = 0.23$ , $L_b = 40$ cm, $\theta_3 = 4.780^\circ$ , $(q_s)_T = 150$ kgf					
Measured Time, t (second)	$(q_w)_T$ (lt/(s.m))	$(q_w)_i$ (lt/(s.m))	$(q_w)_i/(q_w)_T$	$(q_s)_i$ (kgf)	$(q_s)_i/(q_s)_T$
0	9.90	9.81	0.99		
260	29.69	29.39	0.99		
503	50.19	47.64	0.95		
754	69.98	63.49	0.91		
1014	89.77	68.60	0.76		
1221	110.27	76.91	0.70		
1468	130.06	79.22	0.61	52	0.35

Table B.17 Measured parameters of the experiment no: 1 conducted with sediment on trash rack of ( $e_1$ ,  $\theta_3$  and  $L_c$ )

<b><math>e_1/a_1 = 0.23</math>, <math>L_c = 60</math> cm, <math>\theta_3 = 4.780^\circ</math>, <math>(q_s)_T = 150</math> kgf</b>					
<b>Measured Time, t (second)</b>	<b><math>(q_w)_T</math> (lt/(s.m))</b>	<b><math>(q_w)_i</math> (lt/(s.m))</b>	<b><math>(q_w)_i/(q_w)_T</math></b>	<b><math>(q_s)_i</math> (kgf)</b>	<b><math>(q_s)_i/(q_s)_T</math></b>
24	9.19				
99	12.02	12.01	1.00		
227	19.09	18.97	0.99		
340	27.57	27.52	1.00		
470	36.05	35.74	0.99		
579	47.36	46.33	0.98		
704	59.38	57.80	0.97		
823	69.98	64.21	0.92		
920	82.00	76.91	0.94		
1042	91.18	83.93	0.92		
1144	98.96	89.53	0.90		
1236	107.44	92.79	0.86		
1339	113.80	96.91	0.85		
1483	121.58	101.10	0.83		
1606	128.65	105.34	0.82		
1735	132.18	105.34	0.80	64.00	0.43

Table B.18 Measured parameters of the experiment no: 2 conducted with sediment on trash rack of ( $e_1$ ,  $\theta_3$  and  $L_c$ )

<b><math>e_1/a_1 = 0.23</math>, <math>L_c = 60</math> cm, <math>\theta_3 = 4.780^\circ</math>, <math>(q_s)_T = 150</math> kgf</b>					
<b>Measured Time, t (second)</b>	<b><math>(q_w)_T</math> (lt/(s.m))</b>	<b><math>(q_w)_i</math> (lt/(s.m))</b>	<b><math>(q_w)_i/(q_w)_T</math></b>	<b><math>(q_s)_i</math> (kgf)</b>	<b><math>(q_s)_i/(q_s)_T</math></b>
0	9.90	9.81	0.99		
275	29.69	29.39	0.99		
504	50.19	48.96	0.98		
755	69.98	65.66	0.94		
1000	89.77	80.00	0.89		
1229	110.27	93.61	0.85		
1469	130.06	101.94	0.78	65.00	0.43

Table B.19 Measured parameters of the experiment no: 1 conducted with sediment on trash rack of ( $e_2$ ,  $\theta_1$  and  $L_a$ )

$e_2/a_2 = 0.375$ , $L_a = 20$ cm, $\theta_1 = 14.477^\circ$ , $(q_s)_T = 200$ kgf					
Measured Time, t (second)	$(q_w)_T$ (lt/(s.m))	$(q_w)_i$ (lt/(s.m))	$(q_w)_i/(q_w)_T$	$(q_s)_i$ (kgf)	$(q_s)_i/(q_s)_T$
0	9.90	9.81	0.99		
275	29.69	29.39	0.99		
498	50.19	46.33	0.92		
766	69.98	56.41	0.81		
978	89.77	56.41	0.63		
1239	110.27	62.05	0.56		
1474	130.06	67.13	0.52		
1729	149.85	70.84	0.47	85	0.425

Table B.20 Measured parameters of the experiment no: 2 conducted with sediment on trash rack of ( $e_2$ ,  $\theta_1$  and  $L_a$ )

$e_2/a_2 = 0.375$ , $L_a = 20$ cm, $\theta_1 = 14.477^\circ$ , $(q_s)_T = 200$ kgf					
Measured Time, t (second)	$(q_w)_T$ (lt/(s.m))	$(q_w)_i$ (lt/(s.m))	$(q_w)_i/(q_w)_T$	$(q_s)_i$ (kgf)	$(q_s)_i/(q_s)_T$
0	9.90	9.81	0.99		
266	29.69	29.39	0.99		
515	50.19	46.33	0.92		
763	69.98	55.72	0.80		
999	89.77	57.80	0.64		
1220	110.27	61.33	0.56		
1468	130.06	65.66	0.50		
1708	149.85	67.13	0.45	84	0.42

Table B.21 Measured parameters of the experiment no: 1 conducted with sediment on trash rack of ( $e_2$ ,  $\theta_1$  and  $L_b$ )

<b><math>e_2/a_2 = 0.375</math>, <math>L_b = 40</math> cm, <math>\theta_1 = 14.477^\circ</math>, <math>(q_s)_T = 200</math> kgf</b>					
<b>Measured Time, t (second)</b>	<b><math>(q_w)_T</math> (lt/(s.m))</b>	<b><math>(q_w)_i</math> (lt/(s.m))</b>	<b><math>(q_w)_i/(q_w)_T</math></b>	<b><math>(q_s)_i</math> (kgf)</b>	<b><math>(q_s)_i/(q_s)_T</math></b>
0	9.90	9.81	0.99		
283	29.69	29.39	0.99		
514	50.19	49.62	0.99		
735	69.98	63.49	0.91		
974	89.77	80.78	0.90		
1241	110.27	97.74	0.89		
1477	130.06	105.34	0.81		
1711	149.85	115.75	0.77	99.00	0.50

Table B.22 Measured parameters of the experiment no: 2 conducted with sediment on trash rack of ( $e_2$ ,  $\theta_1$  and  $L_b$ )

<b><math>e_2/a_2 = 0.375</math>, <math>L_b = 40</math> cm, <math>\theta_1 = 14.477^\circ</math>, <math>(q_s)_T = 200</math> kgf</b>					
<b>Measured Time, t (second)</b>	<b><math>(q_w)_T</math> (lt/(s.m))</b>	<b><math>(q_w)_i</math> (lt/(s.m))</b>	<b><math>(q_w)_i/(q_w)_T</math></b>	<b><math>(q_s)_i</math> (kgf)</b>	<b><math>(q_s)_i/(q_s)_T</math></b>
0	9.90	9.81	0.99		
293	29.69	29.39	0.99		
501	50.19	49.62	0.99		
746	69.98	65.66	0.94		
1007	89.77	80.78	0.90		
1223	110.27	93.61	0.85		
1481	130.06	107.05	0.82		
1710	149.85	113.99	0.76	98.00	0.49



Table B.23 Measured parameters of the experiment no: 1 conducted with sediment on trash rack of ( $e_2$ ,  $\theta_1$  and  $L_c$ )

<b><math>e_2/a_2 = 0.375</math>, <math>L_c = 60</math> cm, <math>\theta_1 = 14.477^\circ</math>, <math>(q_s)_T = 200</math> kgf</b>					
<b>Measured Time, t (second)</b>	<b><math>(q_w)_T</math> (lt/(s.m))</b>	<b><math>(q_w)_i</math> (lt/(s.m))</b>	<b><math>(q_w)_i/(q_w)_T</math></b>	<b><math>(q_s)_i</math> (kgf)</b>	<b><math>(q_s)_i/(q_s)_T</math></b>
0	9.90	9.81	0.99		
280	29.69	29.39	0.99		
529	50.19	49.62	0.99		
757	69.98	68.60	0.98		
1008	89.77	86.32	0.96		
1253	110.27	105.34	0.96		
1477	130.06	122.87	0.94		
1716	149.85	118.40	0.79	104.50	0.52

Table B.24 Measured parameters of the experiment no: 2 conducted with sediment on trash rack of ( $e_2$ ,  $\theta_1$  and  $L_c$ )

<b><math>e_2/a_2 = 0.375</math>, <math>L_c = 60</math> cm, <math>\theta_1 = 14.477^\circ</math>, <math>(q_s)_T = 200</math> kgf</b>					
<b>Measured Time, t (second)</b>	<b><math>(q_w)_T</math> (lt/(s.m))</b>	<b><math>(q_w)_i</math> (lt/(s.m))</b>	<b><math>(q_w)_i/(q_w)_T</math></b>	<b><math>(q_s)_i</math> (kgf)</b>	<b><math>(q_s)_i/(q_s)_T</math></b>
0	9.90	9.81	0.99		
268	29.69	29.39	0.99		
523	50.19	49.62	0.99		
760	69.98	68.60	0.98		
1006	89.77	85.52	0.95		
1223	110.27	104.48	0.95		
1485	130.06	122.87	0.94		
1712	149.85	121.08	0.81	103.00	0.52

Table B.25 Measured parameters of the experiment no: 1 conducted with sediment on trash rack of ( $e_2$ ,  $\theta_2$  and  $L_a$ )

$e_2/a_2 = 0.375$ , $L_a = 20$ cm, $\theta_2 = 9.594^\circ$ , $(q_s)_T = 200$ kgf					
Measured Time, t (second)	$(q_w)_T$ (lt/(s.m))	$(q_w)_i$ (lt/(s.m))	$(q_w)_i/(q_w)_T$	$(q_s)_i$ (kgf)	$(q_s)_i/(q_s)_T$
0	9.90	9.81	0.99		
261	29.69	29.39	0.99		
506	50.19	44.40	0.88		
750	69.98	55.72	0.80		
985	89.77	58.50	0.65		
1220	110.27	64.21	0.58		
1459	130.06	68.60	0.53		
1706	149.85	73.09	0.49	85.00	0.43

Table B.26 Measured parameters of the experiment no: 2 conducted with sediment on trash rack of ( $e_2$ ,  $\theta_2$  and  $L_a$ )

$e_2/a_2 = 0.375$ , $L_a = 20$ cm, $\theta_2 = 9.594^\circ$ , $(q_s)_T = 200$ kgf					
Measured Time, t (second)	$(q_w)_T$ (lt/(s.m))	$(q_w)_i$ (lt/(s.m))	$(q_w)_i/(q_w)_T$	$(q_s)_i$ (kgf)	$(q_s)_i/(q_s)_T$
0	9.90	9.81	0.99		
259	29.69	29.39	0.99		
514	50.19	46.98	0.94		
760	69.98	55.72	0.80		
1002	89.77	59.21	0.66		
1222	110.27	63.49	0.58		
1454	130.06	68.60	0.53		
1701	149.85	73.09	0.49	86.00	0.43

Table B.27 Measured parameters of the experiment no: 1 conducted with sediment on trash rack of ( $e_2$ ,  $\theta_2$  and  $L_b$ )

$e_2/a_2 = 0.375$ , $L_b = 40$ cm, $\theta_2 = 9.594^\circ$ , $(q_s)_T = 200$ kgf					
Measured Time, t (second)	$(q_w)_T$ (lt/(s.m))	$(q_w)_i$ (lt/(s.m))	$(q_w)_i/(q_w)_T$	$(q_s)_i$ (kgf)	$(q_s)_i/(q_s)_T$
0	9.90	9.81	0.99		
270	29.69	29.39	0.99		
520	50.19	49.62	0.99		
743	69.98	64.21	0.92		
997	89.77	80.00	0.89		
1231	110.27	94.43	0.86		
1459	130.06	109.64	0.84		
1724	149.85	117.52	0.78	98.00	0.49

Table B.28 Measured parameters of the experiment no: 2 conducted with sediment on trash rack of ( $e_2$ ,  $\theta_2$  and  $L_b$ )

$e_2/a_2 = 0.375$ , $L_b = 40$ cm, $\theta_2 = 9.594^\circ$ , $(q_s)_T = 200$ kgf					
Measured Time, t (second)	$(q_w)_T$ (lt/(s.m))	$(q_w)_i$ (lt/(s.m))	$(q_w)_i/(q_w)_T$	$(q_s)_i$ (kgf)	$(q_s)_i/(q_s)_T$
0	9.90	9.81	0.99		
266	29.69	29.39	0.99		
503	50.19	49.62	0.99		
754	69.98	65.66	0.94		
983	89.77	80.78	0.90		
1250	110.27	95.26	0.86		
1468	130.06	109.64	0.84		
1700	149.85	122.87	0.82	100.00	0.50

Table B.29 Measured parameters of the experiment no: 1 conducted with sediment on trash rack of ( $e_2$ ,  $\theta_2$  and  $L_c$ )

$e_2/a_2 = 0.375$ , $L_c = 60$ cm, $\theta_2 = 9.594^\circ$ , $(q_s)_T = 200$ kgf					
Measured Time, t (second)	$(q_w)_T$ (lt/(s.m))	$(q_w)_i$ (lt/(s.m))	$(q_w)_i/(q_w)_T$	$(q_s)_i$ (kgf)	$(q_s)_i/(q_s)_T$
0	9.90	9.81	0.99		
258	29.69	29.39	0.99		
528	50.19	49.62	0.99		
746	69.98	67.13	0.96		
1010	89.77	86.32	0.96		
1217	110.27	102.78	0.93		
1467	130.06	118.40	0.91		
1711	149.85	136.60	0.91	105.00	0.53

Table B.30 Measured parameters of the experiment no: 2 conducted with sediment on trash rack of ( $e_2$ ,  $\theta_2$  and  $L_c$ )

$e_2/a_2 = 0.375$ , $L_c = 60$ cm, $\theta_2 = 9.594^\circ$ , $(q_s)_T = 200$ kgf					
Measured Time, t (second)	$(q_w)_T$ (lt/(s.m))	$(q_w)_i$ (lt/(s.m))	$(q_w)_i/(q_w)_T$	$(q_s)_i$ (kgf)	$(q_s)_i/(q_s)_T$
0	9.90	9.81	0.99		
280	29.69	29.39	0.99		
528	50.19	49.62	0.99		
741	69.98	67.13	0.96		
983	89.77	87.12	0.97		
1247	110.27	103.63	0.94		
1472	130.06	119.29	0.92		
1700	149.85	137.53	0.92	106.00	0.53

Table B.31 Measured parameters of the experiment no: 1 conducted with sediment on trash rack of ( $e_2$ ,  $\theta_3$  and  $L_a$ )

$e_2/a_2 = 0.375$ , $L_a = 20$ cm, $\theta_3 = 4.780^\circ$ , $(q_s)_T = 200$ kgf					
Measured Time, t (second)	$(q_w)_T$ (lt/(s.m))	$(q_w)_i$ (lt/(s.m))	$(q_w)_i/(q_w)_T$	$(q_s)_i$ (kgf)	$(q_s)_i/(q_s)_T$
0	9.90	9.81	0.99		
273	29.69	26.65	0.90		
519	50.19	39.38	0.78		
746	69.98	51.63	0.74		
992	89.77	59.21	0.66		
1228	110.27	63.49	0.58		
1469	130.06	68.60	0.53		
1714	149.85	72.34	0.48	90.00	0.45

Table B.32 Measured parameters of the experiment no: 2 conducted with sediment on trash rack of ( $e_2$ ,  $\theta_3$  and  $L_a$ )

$e_2/a_2 = 0.375$ , $L_a = 20$ cm, $\theta_3 = 4.780^\circ$ , $(q_s)_T = 200$ kgf					
Measured Time, t (second)	$(q_w)_T$ (lt/(s.m))	$(q_w)_i$ (lt/(s.m))	$(q_w)_i/(q_w)_T$	$(q_s)_i$ (kgf)	$(q_s)_i/(q_s)_T$
0	9.90	9.81	0.99		
273	29.69	29.39	0.99		
507	50.19	44.40	0.88		
741	69.98	54.34	0.78		
981	89.77	58.50	0.65		
1219	110.27	61.33	0.56		
1464	130.06	65.66	0.50		
1721	149.85	68.60	0.46	87.00	0.44

Table B.33 Measured parameters of the experiment no: 1 conducted with sediment on trash rack of ( $e_2$ ,  $\theta_3$  and  $L_b$ )

$e_2/a_2 = 0.375$ , $L_b = 40$ cm, $\theta_3 = 4.780^\circ$ , $(q_s)_T = 200$ kgf					
Measured Time, t (second)	$(q_w)_T$ (lt/(s.m))	$(q_w)_i$ (lt/(s.m))	$(q_w)_i/(q_w)_T$	$(q_s)_i$ (kgf)	$(q_s)_i/(q_s)_T$
0	9.90	9.81	0.99		
264	29.69	29.39	0.99		
504	50.19	49.62	0.99		
739	69.98	63.49	0.91		
982	89.77	77.68	0.87		
1216	110.27	91.97	0.83		
1469	130.06	103.63	0.80		
1701	149.85	113.12	0.75	101.00	0.51

Table B.34 Measured parameters of the experiment no: 2 conducted with sediment on trash rack of ( $e_2$ ,  $\theta_3$  and  $L_b$ )

$e_2/a_2 = 0.375$ , $L_b = 40$ cm, $\theta_3 = 4.780^\circ$ , $(q_s)_T = 200$ kgf					
Measured Time, t (second)	$(q_w)_T$ (lt/(s.m))	$(q_w)_i$ (lt/(s.m))	$(q_w)_i/(q_w)_T$	$(q_s)_i$ (kgf)	$(q_s)_i/(q_s)_T$
0	9.90	9.81	0.99		
280	29.69	29.39	0.99		
507	50.19	48.96	0.98		
756	69.98	62.05	0.89		
997	89.77	76.91	0.86		
1221	110.27	91.16	0.83		
1466	130.06	105.34	0.81		
1704	149.85	113.12	0.75	103.00	0.52

Table B.35 Measured parameters of the experiment no: 1 conducted with sediment on trash rack of ( $e_2$ ,  $\theta_3$  and  $L_c$ )

$e_2/a_2 = 0.375$ , $L_c = 60$ cm, $\theta_3 = 4.780^\circ$ , $(q_s)_T = 200$ kgf					
Measured Time, t (second)	$(q_w)_T$ (lt/(s.m))	$(q_w)_i$ (lt/(s.m))	$(q_w)_i/(q_w)_T$	$(q_s)_i$ (kgf)	$(q_s)_i/(q_s)_T$
0	9.90	9.81	0.99		
263	29.69	29.39	0.99		
503	50.19	49.62	0.99		
750	69.98	67.13	0.96		
990	89.77	87.12	0.97		
1223	110.27	103.63	0.94		
1467	130.06	119.29	0.92		
1720	149.85	137.53	0.92	105.00	0.53

Table B.36 Measured parameters of the experiment no: 2 conducted with sediment on trash rack of ( $e_2$ ,  $\theta_3$  and  $L_c$ )

$e_2/a_2 = 0.375$ , $L_c = 60$ cm, $\theta_3 = 4.780^\circ$ , $(q_s)_T = 200$ kgf					
Measured Time, t (second)	$(q_w)_T$ (lt/(s.m))	$(q_w)_i$ (lt/(s.m))	$(q_w)_i/(q_w)_T$	$(q_s)_i$ (kgf)	$(q_s)_i/(q_s)_T$
0	9.90	9.81	0.99		
263	29.69	29.39	0.99		
496	50.19	49.62	0.99		
747	69.98	68.60	0.98		
1000	89.77	87.12	0.97		
1250	110.27	103.63	0.94		
1465	130.06	121.97	0.94		
1702	149.85	139.41	0.93	104.00	0.52

Table B.37 Measured parameters of the experiment no: 1 conducted with sediment on trash rack of ( $e_3$ ,  $\theta_1$  and  $L_a$ )

$e_3/a_3 = 0.5, L_a = 20 \text{ cm}, \theta_1 = 14.477^\circ, (q_s)_T = 200 \text{ kgf}$					
Measured Time, t (second)	$(q_w)_T$ (lt/(s.m))	$(q_w)_i$ (lt/(s.m))	$(q_w)_i/(q_w)_T$	$(q_s)_i$ (kgf)	$(q_s)_i/(q_s)_T$
0	9.90	9.81	0.99		
263	29.69	27.74	0.93		
507	50.19	43.12	0.86		
747	69.98	50.95	0.73		
987	89.77	65.66	0.73		
1233	110.27	76.14	0.69		
1473	130.06	80.78	0.62		
1716	149.85	83.93	0.56	128.00	0.64

Table B.38 Measured parameters of the experiment no: 2 conducted with sediment on trash rack of ( $e_3$ ,  $\theta_1$  and  $L_a$ )

$e_3/a_3 = 0.5, L_a = 20 \text{ cm}, \theta_1 = 14.477^\circ, (q_s)_T = 200 \text{ kgf}$					
Measured Time, t (second)	$(q_w)_T$ (lt/(s.m))	$(q_w)_i$ (lt/(s.m))	$(q_w)_i/(q_w)_T$	$(q_s)_i$ (kgf)	$(q_s)_i/(q_s)_T$
0	9.90	9.81	0.99		
275	29.69	27.19	0.92		
504	50.19	43.76	0.87		
754	69.98	61.33	0.88		
985	89.77	69.34	0.77		
1231	110.27	76.91	0.70		
1466	130.06	81.57	0.63		
1724	149.85	84.72	0.57	131.00	0.66



Table B.39 Measured parameters of the experiment no: 1 conducted with sediment on trash rack of ( $e_3$ ,  $\theta_1$  and  $L_b$ )

$e_3/a_3 = 0.5, L_b = 40 \text{ cm}, \theta_1 = 14.477^\circ, (q_s)_T = 200 \text{ kgf}$					
Measured Time, t (second)	$(q_w)_T$ (lt/(s.m))	$(q_w)_i$ (lt/(s.m))	$(q_w)_i/(q_w)_T$	$(q_s)_i$ (kgf)	$(q_s)_i/(q_s)_T$
0	9.90	9.81	0.99		
277	29.69	29.39	0.99		
512	50.19	49.62	0.99		
746	69.98	67.86	0.97		
981	89.77	85.52	0.95		
1233	110.27	102.78	0.93		
1463	130.06	115.75	0.89		
1718	149.85	124.67	0.83	148.00	0.74

Table B.40 Measured parameters of the experiment no: 2 conducted with sediment on trash rack of ( $e_3$ ,  $\theta_1$  and  $L_b$ )

$e_3/a_3 = 0.5, L_b = 40 \text{ cm}, \theta_1 = 14.477^\circ, (q_s)_T = 200 \text{ kgf}$					
Measured Time, t (second)	$(q_w)_T$ (lt/(s.m))	$(q_w)_i$ (lt/(s.m))	$(q_w)_i/(q_w)_T$	$(q_s)_i$ (kgf)	$(q_s)_i/(q_s)_T$
0	9.90	9.81	0.99		
268	29.69	29.39	0.99		
499	50.19	48.96	0.98		
753	69.98	67.86	0.97		
986	89.77	84.72	0.94		
1223	110.27	102.78	0.93		
1484	130.06	118.40	0.91		
1717	149.85	127.39	0.85	149.00	0.75

Table B.41 Measured parameters of the experiment no: 1 conducted with sediment on trash rack of ( $e_3$ ,  $\theta_1$  and  $L_c$ )

$e_3/a_3 = 0.5$ , $L_c = 60$ cm, $\theta_1 = 14.477^\circ$ , $(q_s)_T = 200$ kgf					
Measured Time, t (second)	$(q_w)_T$ (lt/(s.m))	$(q_w)_i$ (lt/(s.m))	$(q_w)_i/(q_w)_T$	$(q_s)_i$ (kgf)	$(q_s)_i/(q_s)_T$
0	9.90	9.81	0.99		
285	29.69	29.39	0.99		
523	50.19	49.62	0.99		
760	69.98	69.34	0.99		
992	89.77	88.73	0.99		
1239	110.27	108.77	0.99		
1482	130.06	127.39	0.98		
1726	149.85	143.17	0.96	152.00	0.76

Table B.42 Measured parameters of the experiment no: 2 conducted with sediment on trash rack of ( $e_3$ ,  $\theta_1$  and  $L_c$ )

$e_3/a_3 = 0.5$ , $L_c = 60$ cm, $\theta_1 = 14.477^\circ$ , $(q_s)_T = 200$ kgf					
Measured Time, t (second)	$(q_w)_T$ (lt/(s.m))	$(q_w)_i$ (lt/(s.m))	$(q_w)_i/(q_w)_T$	$(q_s)_i$ (kgf)	$(q_s)_i/(q_s)_T$
0	9.90	9.81	0.99		
282	29.69	29.39	0.99		
504	50.19	49.62	0.99		
759	69.98	68.60	0.98		
996	89.77	87.92	0.98		
1229	110.27	106.19	0.96		
1464	130.06	126.49	0.97		
1728	149.85	141.29	0.94	155.00	0.78

Table B.43 Measured parameters of the experiment no: 1 conducted with sediment on trash rack of ( $e_3$ ,  $\theta_2$  and  $L_a$ )

$e_3/a_3 = 0.5, L_a = 20 \text{ cm}, \theta_2 = 9.594^\circ, (q_s)_T = 200 \text{ kgf}$					
Measured Time, t (second)	$(q_w)_T$ (lt/(s.m))	$(q_w)_i$ (lt/(s.m))	$(q_w)_i/(q_w)_T$	$(q_s)_i$ (kgf)	$(q_s)_i/(q_s)_T$
0	9.90	9.81	0.99		
277	29.69	28.29	0.95		
509	50.19	43.12	0.86		
755	69.98	56.41	0.81		
1003	89.77	66.39	0.74		
1228	110.27	73.85	0.67		
1480	130.06	80.00	0.62		
1713	149.85	82.35	0.55	131.50	0.66

Table B.44 Measured parameters of the experiment no: 2 conducted with sediment on trash rack of ( $e_3$ ,  $\theta_2$  and  $L_a$ )

$e_3/a_3 = 0.5, L_a = 20 \text{ cm}, \theta_2 = 9.594^\circ, (q_s)_T = 200 \text{ kgf}$					
Measured Time, t (second)	$(q_w)_T$ (lt/(s.m))	$(q_w)_i$ (lt/(s.m))	$(q_w)_i/(q_w)_T$	$(q_s)_i$ (kgf)	$(q_s)_i/(q_s)_T$
0	9.90	9.81	0.99		
273	29.69	27.74	0.93		
504	50.19	44.40	0.88		
735	69.98	56.41	0.81		
980	89.77	67.86	0.76		
1219	110.27	77.68	0.70		
1480	130.06	83.14	0.64		
1728	149.85	85.52	0.57	129.50	0.65

Table B.45 Measured parameters of the experiment no: 1 conducted with sediment on trash rack of ( $e_3$ ,  $\theta_2$  and  $L_b$ )

$e_3/a_3 = 0.5, L_b = 40 \text{ cm}, \theta_2 = 9.594^\circ, (q_s)_T = 200 \text{ kgf}$					
Measured Time, t (second)	$(q_w)_T$ (lt/(s.m))	$(q_w)_i$ (lt/(s.m))	$(q_w)_i/(q_w)_T$	$(q_s)_i$ (kgf)	$(q_s)_i/(q_s)_T$
0	9.90	9.81	0.99		
283	29.69	29.39	0.99		
529	50.19	49.62	0.99		
751	69.98	67.86	0.97		
990	89.77	85.52	0.95		
1230	110.27	102.78	0.93		
1482	130.06	119.29	0.92		
1716	149.85	131.05	0.87	147.50	0.74

Table B.46 Measured parameters of the experiment no: 2 conducted with sediment on trash rack of ( $e_3$ ,  $\theta_2$  and  $L_b$ )

$e_3/a_3 = 0.5, L_b = 40 \text{ cm}, \theta_2 = 9.594^\circ, (q_s)_T = 200 \text{ kgf}$					
Measured Time, t (second)	$(q_w)_T$ (lt/(s.m))	$(q_w)_i$ (lt/(s.m))	$(q_w)_i/(q_w)_T$	$(q_s)_i$ (kgf)	$(q_s)_i/(q_s)_T$
0	9.90	9.81	0.99		
274	29.69	29.39	0.99		
528	50.19	49.62	0.99		
753	69.98	67.86	0.97		
993	89.77	87.12	0.97		
1229	110.27	104.48	0.95		
1481	130.06	120.18	0.92		
1723	149.85	132.89	0.89	150.00	0.75

Table B.47 Measured parameters of the experiment no: 1 conducted with sediment on trash rack of ( $e_3$ ,  $\theta_2$  and  $L_c$ )

$e_3/a_3 = 0.5, L_c = 60 \text{ cm}, \theta_2 = 9.594^\circ, (q_s)_T = 200 \text{ kgf}$					
Measured Time, t (second)	$(q_w)_T$ (lt/(s.m))	$(q_w)_i$ (lt/(s.m))	$(q_w)_i/(q_w)_T$	$(q_s)_i$ (kgf)	$(q_s)_i/(q_s)_T$
0	9.90	9.81	0.99		
266	29.69	29.39	0.99		
512	50.19	48.96	0.98		
742	69.98	67.86	0.97		
995	89.77	86.32	0.96		
1225	110.27	105.34	0.96		
1479	130.06	123.77	0.95		
1713	149.85	141.29	0.94	157.00	0.79

Table B.48 Measured parameters of the experiment no: 2 conducted with sediment on trash rack of ( $e_3$ ,  $\theta_2$  and  $L_c$ )

$e_3/a_3 = 0.5, L_c = 60 \text{ cm}, \theta_2 = 9.594^\circ, (q_s)_T = 200 \text{ kgf}$					
Measured Time, t (second)	$(q_w)_T$ (lt/(s.m))	$(q_w)_i$ (lt/(s.m))	$(q_w)_i/(q_w)_T$	$(q_s)_i$ (kgf)	$(q_s)_i/(q_s)_T$
0	9.90	9.81	0.99		
277	29.69	29.39	0.99		
507	50.19	49.62	0.99		
749	69.98	68.60	0.98		
988	89.77	87.12	0.97		
1244	110.27	106.19	0.96		
1478	130.06	125.58	0.97		
1714	149.85	141.29	0.94	153.50	0.77

Table B.49 Measured parameters of the experiment no: 1 conducted with sediment on trash rack of ( $e_3$ ,  $\theta_3$  and  $L_a$ )

$e_3/a_3 = 0.5, L_a = 20 \text{ cm}, \theta_3 = 4.780^\circ, (q_s)_T = 200 \text{ kgf}$					
Measured Time, t (second)	$(q_w)_T$ (lt/(s.m))	$(q_w)_i$ (lt/(s.m))	$(q_w)_i/(q_w)_T$	$(q_s)_i$ (kgf)	$(q_s)_i/(q_s)_T$
0	9.90	9.81	0.99		
273	29.69	29.39	0.99		
524	50.19	48.30	0.96		
749	69.98	61.33	0.88		
990	89.77	67.86	0.76		
1234	110.27	76.91	0.70		
1478	130.06	82.35	0.63		
1717	149.85	87.12	0.58	133.00	0.67

Table B.50 Measured parameters of the experiment no: 2 conducted with sediment on trash rack of ( $e_3$ ,  $\theta_3$  and  $L_a$ )

$e_3/a_3 = 0.5, L_a = 20 \text{ cm}, \theta_3 = 4.780^\circ, (q_s)_T = 200 \text{ kgf}$					
Measured Time, t (second)	$(q_w)_T$ (lt/(s.m))	$(q_w)_i$ (lt/(s.m))	$(q_w)_i/(q_w)_T$	$(q_s)_i$ (kgf)	$(q_s)_i/(q_s)_T$
0	9.90	9.81	0.99		
265	29.69	29.39	0.99		
535	50.19	48.30	0.96		
754	69.98	59.21	0.85		
1010	89.77	67.86	0.76		
1247	110.27	73.09	0.66		
1482	130.06	80.78	0.62		
1709	149.85	84.72	0.57	133.00	0.67

Table B.51 Measured parameters of the experiment no: 1 conducted with sediment on trash rack of ( $e_3$ ,  $\theta_3$  and  $L_b$ )

$e_3/a_3 = 0.5, L_b = 40 \text{ cm}, \theta_3 = 4.780^\circ, (q_s)_T = 200 \text{ kgf}$					
Measured Time, t (second)	$(q_w)_T$ (lt/(s.m))	$(q_w)_i$ (lt/(s.m))	$(q_w)_i/(q_w)_T$	$(q_s)_i$ (kgf)	$(q_s)_i/(q_s)_T$
0	9.90	9.81	0.99		
275	29.69	29.39	0.99		
520	50.19	48.96	0.98		
767	69.98	68.60	0.98		
997	89.77	86.32	0.96		
1247	110.27	103.63	0.94		
1480	130.06	116.63	0.90		
1707	149.85	131.97	0.88	148.80	0.74

Table B.52 Measured parameters of the experiment no: 2 conducted with sediment on trash rack of ( $e_3$ ,  $\theta_3$  and  $L_b$ )

$e_3/a_3 = 0.5, L_b = 40 \text{ cm}, \theta_3 = 4.780^\circ, (q_s)_T = 200 \text{ kgf}$					
Measured Time, t (second)	$(q_w)_T$ (lt/(s.m))	$(q_w)_i$ (lt/(s.m))	$(q_w)_i/(q_w)_T$	$(q_s)_i$ (kgf)	$(q_s)_i/(q_s)_T$
0	9.90	9.81	0.99		
266	29.69	29.39	0.99		
497	50.19	49.62	0.99		
754	69.98	66.39	0.95		
991	89.77	85.52	0.95		
1234	110.27	103.63	0.94		
1472	130.06	118.40	0.91		
1709	149.85	132.89	0.89	150.00	0.75

Table B.53 Measured parameters of the experiment no: 1 conducted with sediment on trash rack of ( $e_3$ ,  $\theta_3$  and  $L_c$ )

$e_3/a_3 = 0.5, L_c = 60 \text{ cm}, \theta_3 = 4.780^\circ, (q_s)_T = 200 \text{ kgf}$					
Measured Time, t (second)	$(q_w)_T$ (lt/(s.m))	$(q_w)_i$ (lt/(s.m))	$(q_w)_i/(q_w)_T$	$(q_s)_i$ (kgf)	$(q_s)_i/(q_s)_T$
0	9.90	9.81	0.99		
265	29.69	29.39	0.99		
506	50.19	49.62	0.99		
762	69.98	68.60	0.98		
994	89.77	87.92	0.98		
1233	110.27	107.91	0.98		
1474	130.06	127.39	0.98		
1715	149.85	140.34	0.94	158.00	0.79

Table B.54 Measured parameters of the experiment no: 2 conducted with sediment on trash rack of ( $e_3$ ,  $\theta_3$  and  $L_c$ )

$e_3/a_3 = 0.5, L_c = 60 \text{ cm}, \theta_3 = 4.780^\circ, (q_s)_T = 200 \text{ kgf}$					
Measured Time, t (second)	$(q_w)_T$ (lt/(s.m))	$(q_w)_i$ (lt/(s.m))	$(q_w)_i/(q_w)_T$	$(q_s)_i$ (kgf)	$(q_s)_i/(q_s)_T$
0	9.90	9.81	0.99		
271	29.69	29.39	0.99		
511	50.19	49.62	0.99		
753	69.98	68.60	0.98		
989	89.77	88.73	0.99		
1236	110.27	107.91	0.98		
1463	130.06	126.49	0.97		
1714	149.85	144.12	0.96	158.00	0.79