

TELLURIUM DETERMINATION BY FLAME ATOMIC ABSORPTION
SPECTROMETRY USING A SLOTTED QUARTZ TUBE ATOM TRAP AND
METAL COATINGS

A THESIS SUBMITTED TO
THE GRADUATE SCHOOL OF NATURAL AND APPLIED SCIENCES
OF
MIDDLE EAST TECHNICAL UNIVERSITY

BY

MAHMUT OSMANBAŞOĞLU

IN PARTIAL FULFILLMENT OF THE REQUIREMENTS
FOR
THE DEGREE OF MASTER OF SCIENCE
IN
CHEMISTRY

FEBRUARY, 2011

Approval of the Thesis;

**TELLURIUM DETERMINATION BY FLAME ATOMIC ABSORPTION
SPECTROMETRY USING A SLOTTED QUARTZ TUBE ATOM TRAP AND
METAL COATINGS**

submitted by **MAHMUT OSMANBAŞOĞLU** in a partial fulfillment of the
requirements for the degree of **Master of Science in Chemistry Department, Middle
East Technical University** by

Prof. Dr. Canan Özgen
Dean, Graduate School of **Natural and Applied Sciences** _____

Prof. Dr. İlker Özkan
Head of Department, **Chemistry** _____

Prof. Dr. O. Yavuz Ataman
Supervisor, **Chemistry Department, METU** _____

Examining Committee Members:

Prof. Dr. E. Hale Göktürk
Chemistry Department, METU _____

Prof. Dr. O. Yavuz Ataman
Chemistry Department, METU _____

Prof. Dr. Mürvet Volkan
Chemistry Department, METU _____

Prof. Dr. G. İnci Gökmen
Chemistry Department, METU _____

Doç. Dr. Nusret Ertaş
Pharmacy Department, Gazi University _____

Date: 07/02/2011

I hereby declare that all information in this document has been obtained and presented in accordance with academic rules and ethical conduct. I also declare that, as required by these rules and conduct, I have fully cited and referenced all material and results that are not original to this work.

Name, Last name: Mahmut Osmanbařođlu

Signature

ABSTRACT

TELLURIUM DETERMINATION BY FLAME ATOMIC ABSORPTION SPECTROMETRY USING A SLOTTED QUARTZ TUBE ATOM TRAP AND METAL COATINGS

Osmanbařođlu, Mahmut

M.S., Department of Chemistry

Supervisor: Prof. Dr. O. Yavuz Ataman

February 2011, 75 pages

Flame Atomic Absorption Spectroscopy (FAAS) has lower sensitivity than similar analytical methods, however it has an important place for analysis due to its easy application and economic practicability especially in metal determinations. In order to increase the sensitivity of FAAS from mg/L level to ng/L level, various atom trap systems have been used. One of these atom traps, Slotted Quartz Tube (SQT), which is easy, economical and useful for volatile element determination, is used in this study as a sensitive analytical method for determination of tellurium. In the study, determination of Te by SQT is handled in three different modules. First, only with SQT itself, longer residence time for Te atoms in the measurement zone is provided and consequently 3.2 fold sensitivity enhancement is obtained both for Te (VI) and Te (IV). In the second module, SQT is used for concentration of tellurium species in a lean flame by sending the analyte into SQT for a definite time and trapping them on the inner surface of the SQT. After trapping the analyte, in order to determine the Te concentration, a small

volume (10-50 μL) of organic solvent such as methyl ethyl ketone (MEK) is introduced to the flame for revolatilization and a rapid atomization of Te on the surface is provided. In this trapping method, for 5 minutes collection with a 6 mL/min suction rate, 143 fold enhancement for Te (VI) and 142 fold enhancement for Te (IV) were obtained. In the third module, different from the second one, the inner surface of the SQT is coated with different metals for increasing the amount of Te trapped on the surface and the best enhancement for tellurium is obtained with Tantalum-coated SQT with 252 fold enhancement for Te (VI) and 246 fold enhancements for Te (IV). All improvements are calculated according to the signals obtained in FAAS method. Separate calibration plots were used for Te (IV) and Te (VI).

Keywords: Flame atomic absorption spectrometry, slotted quartz tube, tantalum, tellurium, preconcentration, sensitivity enhancement.

ÖZ

ALEVLİ ATOMİK ABSORPRİYON SPEKTROMETRESİ İLE YARIKLI KUVARS TÜP ATOM TUZAĞI KULLANARAK TELLURYUM TAYİNİ

Osmanbaşođlu, Mahmut

Yüksek Lisans, Kimya Bölümü

Tez Yöneticisi: Prof. Dr. O. Yavuz Ataman

Şubat 2011, 75 sayfa

Alevli Atomik Absorpsiyon Spektrometri (FAAS) benzer birçok metoda göre daha düşük duyarlılığa sahip olmasına rağmen hala önemli bir analiz metodudur; çünkü bu teknik, özellikle metal tayininde kolaylıkla ve ekonomik bir şekilde uygulanabilmektedir. FAAS metodunun gözlenebilme sınırını mg/L düzeyinden ng/mL düzeyine indirebilmek amacıyla son yıllarda atom tuzakları kullanılmaya başlanmıştır. Bu atom tuzaklarından bir tanesi olan ve uçucu element tayininde kullanılmasının yanı sıra basit ve ekonomik olan yarıklı kuvars tüp (YKT), bu çalışmada, teluryumun FAAS yöntemi ile tayininde kullanılmış ve daha duyarlı bir analitik metot önerilmiştir. YKT kullanılarak tayin yaparken üç farklı modül üzerinde çalışılmıştır. İlk olarak, Te atomlarının ölçüm yapılan bölgedeki kalma süresini artırmaya yönelik sadece YKT kullanılarak ölçümler yapılmış olup bunun sonucunda hem Te (VI) hem de Te (IV) için 3.2 kat duyarlılık artışı gözlenmiştir. İkinci olarak, YKT'nin teluryum ön-zenginleştirilmelerinde kullanılmasına yönelik olarak düşük yakıtlı aleve gönderilen analit YKT'nin iç yüzeyinde belli bir süre biriktirilmiştir. Daha sonra, aleve düşük hacimde (10-50 µL) metil etil keton (MEK) gibi organik çözücü püskürtülmesi ile

tuzaklanmış analit türleri buharlaşp hızla atomlaşmaktadır. Bu tuzaklama yönteminde, 5 dakikalık toplama süresi ve 6 mL/dk analit çekiş hızında Te (VI) için 143 kat, Te (IV) için ise 142 kat duyarlılık artışı elde edilmiştir. Son uygulamada ise, ikinci uygulamadan farklı olarak YKT'nin iç yüzeyi bazı metallerle kaplanmış ve en yüksek duyarlılık artışı, Tantalum (Ta) kaplı YKT kullanılması sonucunda Te (VI) için 252 kat ve Te (IV) için ise 246 kat olarak hesaplanmıştır. Duyarlılık artışları alevli AAS'de elde edilen sinyallere göre hesaplanmıştır. Teluryum ile yapılan kalibrasyon çalışmalarında hem Te (IV) hem de Te (VI) için ayrı değerler hesaplanmıştır.

Anahtar Kelimeler: Alevli atomik absorpsiyon spektrometri, yarıklı kuvars tüp, tantalum, teluryum, önzenginleştirme, duyarlılık artışı.

To My Family; Gülsen.

ACKNOWLEDGEMENTS

I wish to express my gratitude to my supervisor Prof. Dr. O. Yavuz Ataman for his guidance, understanding and suggestions throughout this research.

I would like to thank to Yasin Arslan and Emrah Yıldırım for their endless patience, guidance and contribution in each part of this study.

I also want to thank Necati Koç for his help, and all AtaMAn Research and C-50 group members for their understanding and friendship.

Finally, my special thanks to my wife for her trust, patience, support and love.

TABLE OF CONTENTS

ABSTRACT	iv
ÖZ	vi
ACKNOWLEDGEMENTS	ix
TABLE OF CONTENTS	x
LIST OF TABLES	xiii
LIST OF FIGURES	xiv
LIST OF ABBREVIATIONS	xvii
CHAPTER 1	1
INTRODUCTION	1
1.1. Tellurium.....	2
1.1.1. Tellurium and Tellurium Sources	2
1.1.2. Tellurium and Health	2
1.2. Determination of Tellurium	3
1.2.1. Determination of Tellurium by Plasma Techniques	3
1.2.2. Determination of Tellurium by Atomic Absorption Spectrometry	4
1.2.2.1. Electrothermal Atomic Absorption Spectrometry	4
1.2.2.2. Hydride Generation Atomic Absorption Spectrometry	5
1.2.2.3. Flame Atomic Absorption Spectrometry	5
1.3. Atom Trapping Techniques in AAS	6
1.3.1. Atom Traps for HG Techniques.....	7
1.3.1.1. Graphite Furnace Atom Trap for Hydride Generation Techniques	7
1.3.1.2. Quartz Atom Traps for Hydride Generation Techniques.....	7
1.3.2. Metal Atom Traps for Vapor Generation Techniques	8
1.3.3. Atom Traps for FAAS.....	8
1.3.3.1. Long-Path Absorption Tube Method	9

1.3.3.2.	Delves' Microsampling Cup Method.....	9
1.3.3.3.	Water-Cooled Silica Atom Trap Method.....	10
1.3.3.4.	Integrated Atom Trap Method	11
1.3.3.5.	SQT Atom Trap Method	12
1.4.	Atomization in FAAS-SQT-AT	15
1.4.1.	Flame Alteration Technique.....	15
1.4.2.	Organic Solvent Aspiration Technique.....	15
1.5.	Aim of the Study	16
CHAPTER 2		17
EXPERIMENTAL.....		17
2.1.	Apparatus and Materials	17
2.2.	Chemicals and Reagents	17
2.3.	Atomic Absorption Spectrometer	18
2.4.	Coating Procedure of SQT	19
CHAPTER 3		20
RESULTS AND DISCUSSION		20
3.1.	FAAS Study for Tellurium	21
3.1.1.	Optimization of Flow Rate of Acetylene	21
3.1.2.	Optimization of Sample Suction Rate.....	22
3.1.3.	Calibration Plot for Te (VI) in FAAS	23
3.1.4.	Calibration Plot for Te (IV) in FAAS Method.....	25
3.2.	SQT - FAAS Method for Tellurium	27
3.2.1.	Optimization of AFR	27
3.2.2.	Optimization of SFR	28
3.2.3.	Optimization of DSQT.....	29
3.2.4.	Calibration Plots for Te (VI) in SQT-FAAS Method	30
3.2.5.	Calibration Plots for Te (IV) in SQT-FAAS Method	32
3.3.	SQT-AT-FAAS Method for Tellurium.....	34
3.3.1.	Effect of Organic Solvent	34

3.3.2.	Optimization of VOS	36
3.3.3.	Optimization of SFR	37
3.3.4.	Optimization of AFR	38
3.3.5.	Optimization of DSQT.....	39
3.3.6.	Effect of Trapping Period	40
3.3.7.	Calibration Plots for Te (VI) in SQT-AT-FAAS	42
3.3.8.	Calibration Plots for Te (IV) in SQT-AT-FAAS Method.....	44
3.4.	Optimizations of Coated-SQT-AT-FAAS for Tellurium.....	47
3.4.1.	Examination of Coating Material on SQT-AT-FAAS Method.....	48
3.4.2.	Effect of Organic Solvent	49
3.4.3.	Optimization of VOS	49
3.4.4.	Optimization of SFR	50
3.4.5.	Optimization of AFR	51
3.4.6.	Optimization of DSQT.....	52
3.4.7.	Effect of Trapping Period	53
3.4.8.	Calibration Plots for Te (VI) in Ta-coated-SQT-AT-FAAS	56
3.4.9.	Calibration Plots for Te (IV) in Ta-coated-SQT-AT-FAAS Method.....	58
3.5.	Evaluation of System Performance.....	60
3.6.	Interference Effects of Various Elements in Ta-Coated SQT-AT-FAAS.....	63
CHAPTER 4		70
CONCLUSIONS.....		70
REFERENCES.....		72

LIST OF TABLES

Table 2.1 Operating Conditions for FAAS.....	18
Table 3.1 Analytical Performance with FAAS for Te (VI).....	25
Table 3.2 Analytical Performance with FAAS for Te (IV)	27
Table 3.3 Analytical Performance of Te (VI) for SQT-FAAS.....	32
Table 3.4 Analytical Performance of Te (IV) for SQT-FAAS.....	34
Table 3.5 Effect of Organic Solvents on Te Signals for SQT-AT-FAAS Method.....	35
Table 3.6 Molecular Formulas and Flash Points of Organics used for volatilization of Te.....	36
Table 3.7 Conditions for SQT-AT-FAAS Method	41
Table 3.8 Analytical Performance of SQT-AT-FAAS for Te (VI).....	44
Table 3.9 Analytical Performance of SQT-AT-FAAS for Te (IV).....	47
Table 3.10 Analytical Figures of Merit.....	47
Table 3.11 Coating Effect on 250.0 ng/mL Te (VI) Signal in SQT-AT-FAAS	48
Table 3.12 Effect of Organic Solvents on 250.0 ng/mL Te (VI) Signal for Ta-coated-SQT-AT-FAAS Method.....	49
Table 3.13 Optimized Conditions for Ta-Coated-SQT-AT-FAAS Method..	55
Table 3.14 Analytical Performance of Te (VI) for Ta-Coated-SQT-AT-FAAS.....	58
Table 3.15 Analytical Performance of Te (IV) for Ta-Coated-SQT-AT-FAAS.....	60
Table 3.16 Comparison of Methods in Terms of E, Et and Ev Values.....	61
Table 3.17 Comparison of Developed Methods with Other Techniques.....	62
Table 3.18. Summary for Interference Studies of Ta-Coated-SQT-AT-FAAS.....	68

LIST OF FIGURES

Figure 1.1 A long-tube absorption cell. (a) Open ended, (b) T-shaped.....	9
Figure 1.2 Schematic representation of Delves' microsampling cup system.....	10
Figure 1.3 Schematic representation of water-cooled U-tube atom trap.....	12
Figure 1.4 Schematic representation of integrated atom trap system.....	13
Figure 1.5 Different profile images of slotted quartz tube, SQT.....	16
Figure 3.1 Acetylene flow rate for 10.0 mg/L Te (VI) in FAAS	23
Figure 3.2 Optimized SFR for 10.0 mg/L Te (VI) in FAAS.....	24
Figure 3.3 Calibration plot for Te (VI) in FAAS method	25
Figure 3.4 Linear calibration plot for Te (VI) FAAS method.....	25
Figure 3.5 Calibration plot for Te (IV) in FAAS method	27
Figure 3.6 Linear calibration plot for Te (IV) FAAS method.....	27
Figure 3.7 Optimization of AFR for 10.0 mg/L Te (VI) in SQT-FAAS	28
Figure 3.8 Optimization of SFR for 10.0 mg/L Te (VI) in SQT-FAAS.....	29
Figure 3.9 Optimization of DSQT for 10.0 mg/L Te (VI) in SQT-FAAS.....	30
Figure 3.10 Calibration plot for Te (VI) in SQT-FAAS method.....	31
Figure 3.11 Linear calibration plot for Te (VI) in SQT-FAAS method.....	31
Figure 3.12 Calibration plot for Te (IV) in SQT-FAAS method.....	33
Figure 3.13 Linear calibration plot for Te (IV) in SQT-FAAS method.....	33
Figure 3.14 Optimization of the volume of organic solvent using 250.0 ng/mL Te (VI) in SQT-AT-FAAS.....	37
Figure 3.15 Optimization of SFR for 250.0 ng/mL, 24.0 mL Te (VI) in SQT-AT-FAAS	38

Figure 3.16 Optimization of AFR for 250.0 ng/mL Te in SQT-AT-FAAS...	39
Figure 3.17 Optimization of height of SQT from the burner using 250.0 ng/mL Te in SQT-AT-FAAS	40
Figure 3.18 Effect of TP for 250.0 ng/mL of Te (VI) solution in SQT-AT-FAAS	41
Figure 3.19 The signal of SQT-AT-FAAS for 250.0 ng/mL Te (VI) solution.....	42
Figure 3.20 Calibration plot for Te (VI) in SQT-AT-FAAS method using the conditions in Table 3.7.....	43
Figure 3.21 Linear calibration plot for Te (VI) in SQT-AT-FAAS method using the conditions in Table 3.7.....	43
Figure 3.22 Calibration plot for Te (IV) in SQT-AT-FAAS method using the conditions in Table 3.4.....	45
Figure 3.23 Linear calibration plot for Te (VI) in SQT-AT-FAAS method using the conditions in Table 3.4.....	45
Figure 3.24 Optimization of VOS for 250.0 ng/mL Te (VI) in Ta-Coated-SQT-AT-FAAS	50
Figure 3.25 Optimization of SFR for 24 mL of 250.0 ng/mL Te (VI) in Ta Coated-SQT-AT-FAAS.....	51
Figure 3.26 Optimization of AFR for 250 ng/mL Te (VI) in Ta-Coated-SQT-AT-FAAS	52
Figure 3.27 Optimization of DSQT for 250 ng/mL Te (VI) in Ta-Coated-SQT-AT-FAAS	53
Figure 3.28 Effect of TP on 250 ng/mL Te (VI) in Ta-Coated-SQT-AT-FAAS	54
Figure 3.29 The signal of Ta-Coated-SQT-AT-FAAS for 250.0 ng/mL Te solution, using the conditions in Table 3.13.....	55
Figure 3.30 Calibration plot for Te (VI) in Ta-Coated-SQT-AT-FAAS with conditions listed in Table 3.13.....	56

Figure 3.31 Linear calibration plot for Te (VI) in Ta-Coated-SQT-AT-FAAS with conditions listed in Table 3.13.....	57
Figure 3.32 Calibration plot for Te (VI) in Ta-Coated-SQT-AT-FAAS with conditions listed in Table 3.13.....	59
Figure 3.33 Linear calibration plot for Te (IV) in Ta-Coated-SQT-AT-FAAS with conditions listed in Table 3.13.....	59
Figure 3.34 Interferant effects of Fe, Cu and Al for 100.0 ng/mL Te (VI) in Ta-Coated-SQT-AT-FAAS.....	63
Figure 3.34 Interferant effects of Fe, Cu and Al for 100.0 ng/mL Te (IV) in Ta-Coated-SQT-AT-FAAS.....	65
Figure 3.35 Interferant effects of As, Sb, and Se for 100.0 ng/mL Te (VI) in Ta-Coated-SQT-AT-FAAS.....	64
Figure 3.35 Interferant effects of As, Sb, and Se for 100.0 ng/mL Te (IV) in Ta-Coated-SQT-AT-FAAS.....	65
Figure 3.36 Interferant effects of Na, Ca and Al for 100.0 ng/mL Te (VI) in Ta-Coated-SQT-AT-FAAS.....	66
Figure 3.36 Interferant effects of Na, Ca and Al for 100.0 ng/mL Te (IV) in Ta-Coated-SQT-AT-FAAS.....	66

LIST OF ABBREVIATIONS

AAS	Atomic Absorption Spectrometry
ETAAS	Electrothermal Atomic Absorption Spectrometry
FAAS	Flame Atomic Absorption Spectrometry
GFAAS	Graphite Furnace Atomic Absorption Spectrometry
HGAAS	Hydride Generation Atomic Absorption Spectrometry
ICPMS	Inductively Coupled Plasma Mass Spectrometry
ICPOES	Inductively Coupled Plasma Optical Emission Spectrometry
MEK	Methyl Ethyl Ketone
MIBK	Methyl Isobutyl Ketone
SRM	Standard Reference Material
SQT	Slotted Quartz Tube
SQT-AT	Slotted Quartz Tube Atom Trap
SQT-AT-FAAS	Slotted Quartz Tube Atom Trap Flame Atomic Absorption Spectrometry
SQT-FAAS	Slotted Quartz Tube Flame Atomic Absorption Spectrometry

CHAPTER 1

INTRODUCTION

Heavy metals like As, Te, Pb, Hg, Cd, Tl and Cu have many adverse effects not only on human health, but also on animals and environment even at very low concentrations. For this reason, investigation of more powerful methods for determination of the concentration of these metals in various samples is very crucial. These elements are in trace amounts; therefore, highly sensitive techniques with very low detection limits are necessary. There are some hyphenated methods such as Inductively Coupled Plasma Optical Emission Spectrometry (ICP-OES) and Inductively Coupled Plasma Mass Spectrometry (ICP-MS) which are recently used due to their rapid and precise results as well as low detection limits attained. These techniques seem suitable for detection of heavy metals, however purchasing and running costs make them less suitable than other economic and easy techniques. Due to its simplicity, low cost and availability in most analytical chemistry laboratories, Atomic Absorption Spectrometry (AAS) is still more popular than the aforementioned hyphenated techniques especially in developing countries.

In this study, a new and simple AAS technique that is the regular flame AAS and various modifications of slotted quartz tube (SQT) device on sensitive tellurium analysis was developed and presented.

1.1. Tellurium

1.1.1. Tellurium and Tellurium Sources

Tellurium belongs to group 16 in periodical chart including O, S, and Se. Its atomic number is 52; atomic weight is 127.60, its melting point 449.8 °C, and boiling point 989.9 °C [1]. Elemental tellurium is a silvery white, metallic, lustrous solid that is quite brittle. Tellurium exists in two different allotropic formations. First one is hexagonal crystalline and second one is amorphous powder. Chemical properties of tellurium are similar to Se and S. However, its metallic character is more than these ones. Tellurium has different valence number; common ones are 2⁻, 4⁺, and 6⁺ [1].

Elemental tellurium is not soluble in water, benzene, or carbondisulfide. In air, burning tellurium gives a green-like blue flame [2].

The abundance of tellurium in crust is 2.00×10^{-9} %. It is a byproduct of the copper-refining industry. Tellurium is produced approximately 65 tons per year in the world [3].

1.1.2. Tellurium and Health

By occupational exposure of Te, there are some toxicological effects such loss of appetite, mouth dry, sweat suppressing, and a metal-like taste [1].

Fortunately, only a few people have exposed with tellurium compounds. They are teratogenic; therefore they should be handled by suitable experts. Because, ingestion of a small amount may causes terrible smell in breath. The absorption of substance can irritate the eyes and the respiratory system. It may also affect the liver and central nervous system. Medical observation indicates that in case of ingestion, abdominal pain, constipation and vomiting are observed in the patients [4].

1.2. Determination of Tellurium

The mainly used methods of tellurium analysis are plasma techniques such as ICP-OES, ICP-MS, and atomic absorption spectrometric methods like ETAAS, HGAAS and FAAS. Each of these methods has both advantages and disadvantages in terms of their precision, cost and simplicity.

1.2.1. Determination of Tellurium by Plasma Techniques

ICP-OES technique is based on converting the sample components into atoms and ions exciting to higher electronic states in order to obtain ultraviolet and visible line emission spectra that are used for qualitative and quantitative elemental analysis [5].

ICP-OES is a quite sensitive technique, however, level of tellurium in many samples lies below the detection limit. In addition to this, there are some spectral interferences such as Cr, V, Ge and Co and this technique requires some pre-concentration and separation techniques for determination of tellurium [5].

Another plasma technique for determination of tellurium is the ICP-MS. This technique consists of four steps; first of all, atomization of the analyte with a plasma source, then conversion of atoms into ions, after that, separation of ions on the basis of their mass to charge ratio and finally counting of the ions of each type. In this technique, detection limits are about hundred times better than ICP-OES and it is also possible to obtain atomic isotopic ratios [5]. In another study, Te in environmental samples has been determined by ICP-MS with the Carius Tube Digestion [6]. ICP-MS could be combined with electrothermal vaporization technique in order to determine Te in sea water and human hair samples [7].

1.2.2. Determination of Tellurium by Atomic Absorption Spectrometry

The technique is based on the radiation absorption by free atomized elements. Each element has its specific wavelength for absorption; absorbances of elements are proportional to concentration of atoms of ground state.

Components of an atomic absorption spectrometer (AAS) are a radiation source, atomizer, a monochromator, a detector and electronics for data acquisition, processing and editing [5]. Hollow cathode lamps (HCL) and electrodeless discharge lamps (EDL) are used as radiation source of the AAS. The atomizer is the part that atomization of analyte atoms takes place with the help of flame, graphite tube or heated quartz tube. The atomizer is located between radiation source and monochromator in the system. The efficiency of an atomizer determines the amount of analyte atomized.

The most sensitive analytical line of Te is 213.4 nm, but there are other wavelengths that can also be used instead of these lines such as 225.9 nm and 238.58 nm [8].

There are three types of AA techniques used in determination of tellurium; ETAAS, HGAAS and FAAS. ETAAS and HGAAS techniques provide sensitivity improvement of 100-1000 fold over FAAS [9].

1.2.2.1. Electrothermal Atomic Absorption Spectrometry

ETAAS is based on atomizing the sample solution (10-50 μL) by an electrothermal atomizer which usually is a graphite furnace. In this technique, the temperature has increased step-by-step in order to remove of solvent and matrix of the analyte before the atomization. After removing the solution and matrix, temperature has increased to atomization level then a rapid (generally in less than 1 second) atomization occurs. A peak-shaped and time dependent signal is obtained in which the area beneath peak is relative to amount of the analyte in the sample solution [8].

ETAAS is used for determination of trace inorganic tellurium and selenium by using a simple and effective speciation technique before the ETAAS. In this method up to 520 fold enrichment for Te (IV) and 480 fold enrichment for Se (IV) [10].

In another study, determination of Te (IV) and Te (VI) has been carried out by dispersive liquid–liquid micro extraction and ETAAS with palladium as permanent modifier [11].

Iridium modifier could also be used as permanent modifier in ETAAS in determination of Te, Bi and Ag [12].

1.2.2.2. Hydride Generation Atomic Absorption Spectrometry

Another AA method for tellurium determination can be considered as HGAAS. In this technique, analyte is first converted into its hydride form that is obtained by addition of an acidified aqueous solution of sample to a small volume of aqueous solution of NaBH_4 or metal/acid mixture such as Zn/HCl . For atomization of the analyte, a quartz tube which is generally externally heated by flame is used. The atomizer is kept at $800\text{--}900^\circ\text{C}$ in order to obtain decomposition of hydride and formation of analyte atoms [6, 8].

The HGAFS, which is similar to HGAAS is used for determination of As, Bi, Te and Se in tea leaves by simultaneous multi-channel hydride generation atomic fluorescence spectrometry method [13].

1.2.2.3. Flame Atomic Absorption Spectrometry

The final AA technique for tellurium determination is FAAS. In this technique, a flame is used for atomization. This technique requires a device, which converts the sample solution into aerosol and sprays into flame, consists of a nebulizer and a spray chamber.

There are different kinds of nebulizers and the most common one is the concentric tube. In the concentric tube nebulizer, with the help of a capillary tube the liquid sample is aspirated by the high pressure stream of gas flowing around the tip of tube. In this case, the liquid sample is broken up into many colloidal droplets and transported to the flame [14].

In FAAS, air/acetylene and N₂O/acetylene are mostly used among several flames. Air/acetylene flame has temperature range between 2100-2400 °C, and used in determination of elements such as Ca, Cr, Cu, Co, Fe, Ni, Mg, Sr whose oxides are not refractory. Temperature of nitrous oxide-acetylene flame ranges in between 2600-2800 °C and it is used for elements such as Al, Si, Ta, Ti, V, Zr [5]. Determination of tellurium by FAAS can be performed using an air-acetylene flame.

There are three important disadvantages of FAAS with respect to other AAS techniques. The first one is the low nebulization efficiency; only 1-10% of sample could arrive to the flame. The second one is dilution of analyte with flame gases. The third one is the relatively short residence time of analyte species which is in order of few milliseconds. Sensitivity of FAAS is limited by these disadvantages [9] and therefore atom trapping techniques are needed.

1.3. Atom Trapping Techniques in AAS

Atom traps have been built up in order to raise the residence time of analyte species in the measurement zone and for preconcentration [15]. Various metal and quartz traps and furnaces are used for enhancement of the analyte in HG-AAS. For FAAS, long-path absorption tube, Delves' microsampling cup [16] and slotted quartz tube are used for increasing the retention time of analyte atoms in the measurement zone; integrated atom trap and slotted quartz tube atom trap are used for preconcentration.

1.3.1. Atom Traps for HG Techniques

Hydride generation (HG) has an effective sample introduction applicable to hydrides of elements like As, Bi, Sn, Ge, Tl, and Te by the efficient transportation and atomization of gaseous hydride [5]; the first application was for arsenic [17]. In this technique, three different kinds of atom traps have been developed for sensitivity improvement; graphite furnace, quartz and metal atom traps.

1.3.1.1. Graphite Furnace Atom Trap for Hydride Generation Techniques

Graphite furnace (GF) is used also as an atom trap when it is coupled with hydride generation in determination of metal hydrides that are transported to GF and pre-heated in between 200-800°C. In GF, volatile hydrides are decomposed and analyte atoms have been trapped on surface of graphite that causes clean, rapid separation from matrix. After the completion of trapping period, the analyte is atomized [18].

Platinum group elements can be used for coating the inner surface of GF for enhancing the sensitivity. The presence of these types of elements with GF reduces the trapping temperatures of the analyte [19]. For instance, in a study by Yan and Ni, when the inner surface of GF was coated with Zr for Pb determination by HGAAS, 6 fold enhancement of sensitivity is obtained with respect to that obtained by using the uncoated tube. The sorption temperature of Pb on surface of coated GF was only 100°C on Zr surface although it was higher than 600°C on the surface of uncoated GF [20].

1.3.1.2. Quartz Atom Traps for Hydride Generation Techniques

Quartz atom trap has been firstly applied in Pb determination [21]. The steps of this technique are described by Ataman [9] as;

- a) Lead hydride (PbH_4) is formed by reacting analyte in hydrochloric acid in the presence of NaBH_4 .

- b) With the help of a liquid-gas separator, vapor of the analyte is separated and transported to the quartz that has an optimized collection temperature;
- c) The system is heated up to its revolatilization temperature then the analyte species are released and transported via using a proper carrier gas to quartz atomizer in the presence of hydrogen gas where the transient signal is formed.

In a study on trapping of TeH_4 electrically heated and Pt-coated W-coil, Te determination has been carried out; in this method 28 fold enhancement with respect to conventional HGAAS was obtained [22].

1.3.2. Metal Atom Traps for Vapor Generation Techniques

As an alternative atomizer, metal traps have often been used; metal atom trap is heated when electricity is passing through the device. The W coil is one of the most popular traps used firstly for on-line preconcentration of Bi [23], and for Se determination [24], and then for determination of Sb [25] in Ataman research group.

W coil that is coated with Rh has been used for both preconcentration and for atomizing in determination of Se [23].

1.3.3. Atom Traps for FAAS

Although flame AAS is a simple, stable and economic technique, its sensitivity is not enough for heavy metal analysis especially in lower concentration level. Sensitivity improvement could be achieved by (a) introducing sample solution with an effective nebulization, (b) making the atomic vapor stay longer in source pathway, and by (c) using a special atomizer.

1.3.3.1. Long-Path Absorption Tube Method

In this method, absorption medium is kept in cylindrical form made of silica, alumina and ceramic tubes with a length of 1 m along the longitudinal axis in which absorbed light passes through the optical path. There are two types of long-path absorption tube; (a) open ended and (b) T-shaped shown in Figure 1.1. The performance of the method depends on the life time of free atoms and life time changes with element, temperature and composition of flame gases [15].

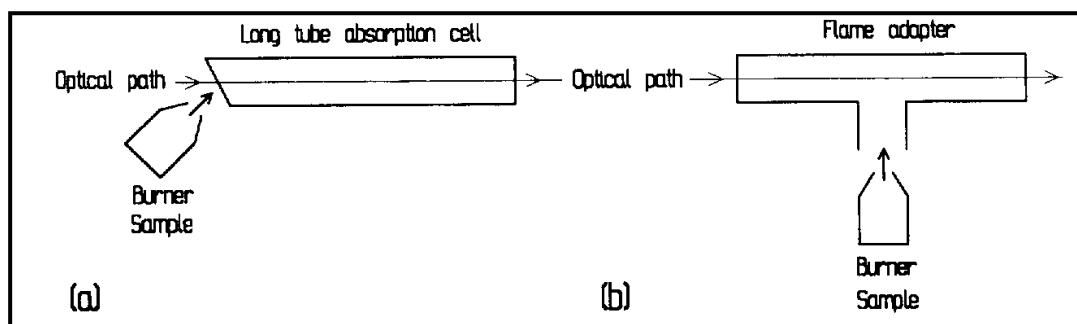

Figure 1.1 A long-tube absorption cell. (a) Open ended, (b) T-shaped [15].

In this technique, in propane-butane-air flame, 5-13 fold enhancements for the copper, silver, gold and cadmium determination was observed [26].

1.3.3.2. Delves' Microsampling Cup Method

In Delves' microsampling Cup, a nickel cup and an absorption tube in flame are used as shown in Figure 1.2 [16]. Absorption tube that is made by a nickel foil is positioned in a flame and placed 20 mm above the burner which is parallel to the burner slots. The sample is put into the nickel cup, and vaporized through an open-ended absorption tube then atomized. Compared to pneumatic nebulization techniques, this device gives high sensitivity because of the sample transfer efficiency to the flame [15].

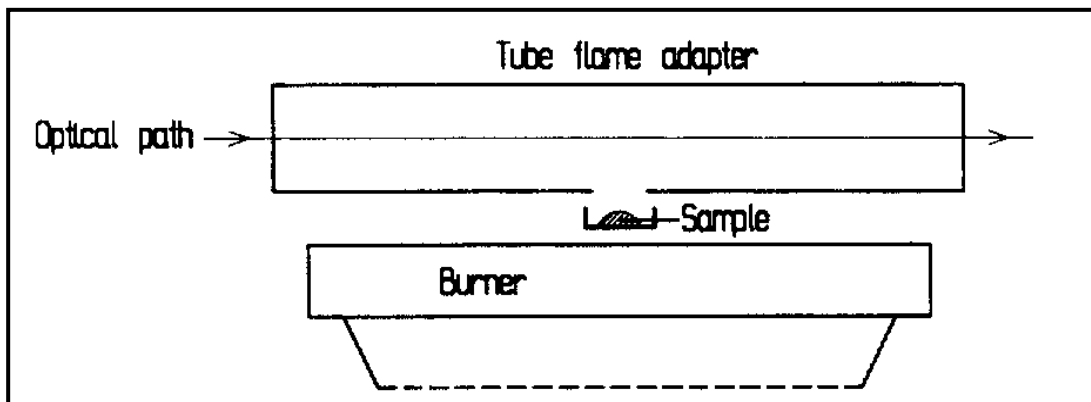

Figure 1.2 Schematic representation of Delves' microsampling cup system [15].

Delves' Microsampling Cup method requires very small volume of sample; therefore it is used for investigation of clinical, industrial and environmental samples. It is very effective for determination of volatile elements like, tellurium and cadmium. However the system is not commercially available due to very sensitive operating conditions [15].

1.3.3.3. Water-Cooled Silica Atom Trap Method

In this method; a silica U-tube that is cooled by flow of cold water, is placed below the optical path of the AA spectrometer. Analyte atoms are nebulized as regularly but condensed on the outer surface of silica U-tube. After collecting analyte atoms on the surface of silica tube, the water flow is switched off and an air stream is sent from the tube which helps the silica surface to be rapidly heated. This rapid heating lets the condensed analyte atoms released and signal is obtained [9].

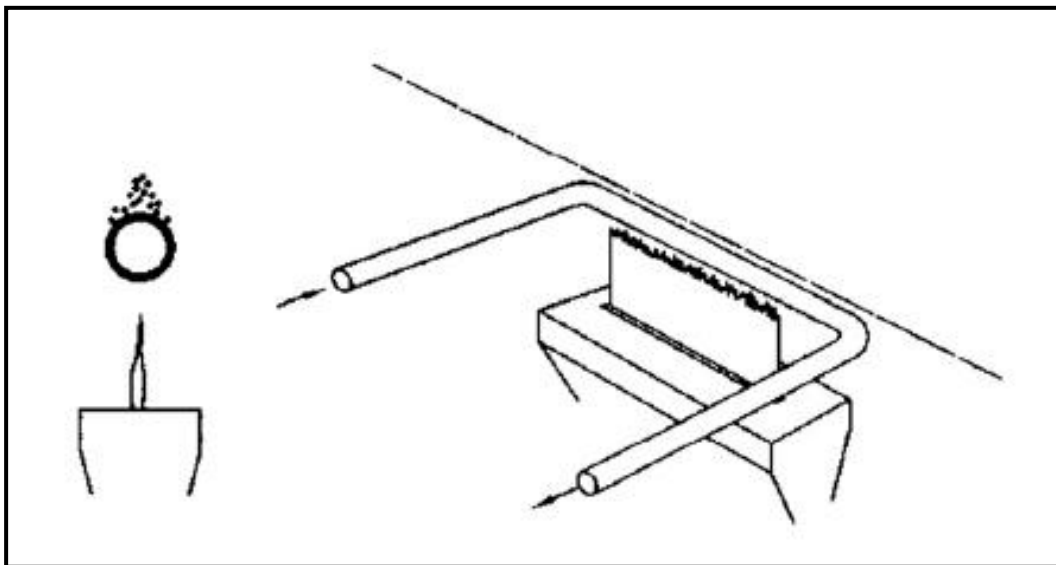

Figure 1.3 Schematic representation of water-cooled U-tube atom trap [9]

This technique does not work for elements with high melting point due to the fact that they are trapped but not re-atomized. The same reason is also valid for alkaline and alkaline earth elements. They are strongly attached to the silica surface, so they could not be released [15].

The water-cooled trap is inexpensive, simple to use and permits the analysis of various materials; however it is slow because of the atom trapping period and also life time of the silica tube is not much due to the thermal shocks caused by rapid heating [27].

In a study, water cooled trap method gave 17 fold enhancement for Pb and 19 fold enhancement for Cd with respect to flame AAS technique [28].

1.3.3.4. Integrated Atom Trap Method

This technique (IAT) is combination of water-cooled silica tube and a SQT [15]. Working principle of the system is shown in Figure 1.5. By integrating trap techniques, one can obtain both sensitivity and detection limit.

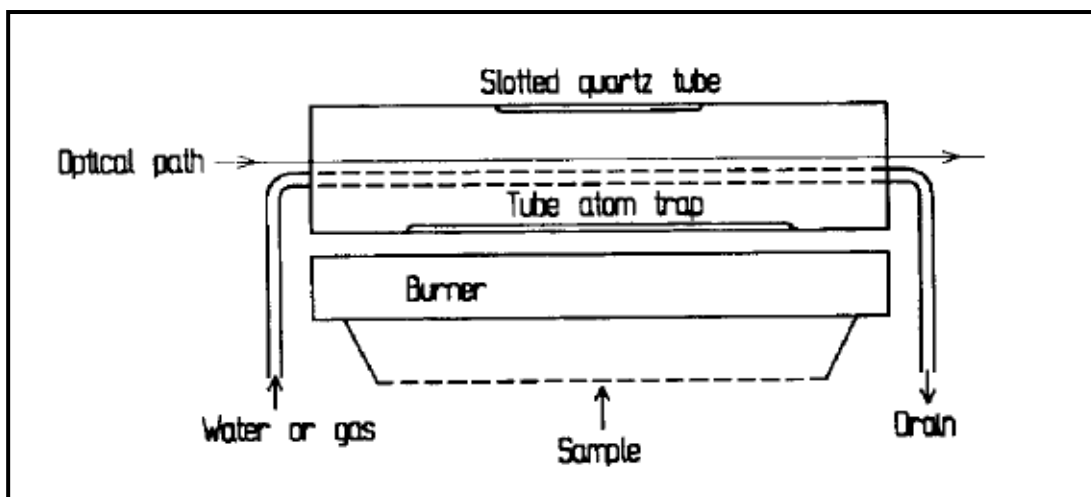

Figure 1.4 Schematic representation of integrated atom trap system [15]

Although the system is simple, robust and has low cost, it is limited to only few elements and high volume of sample is necessary for the trapping [29].

Another disadvantage of the method is the significant light obscuration caused by placing a silica trap into the SQT that decreases the sensitivity. In addition, the condensed water on the cold silica trap surface causes some occasional water drops on SQT that results background signal [30].

In a study, water-cooled trap with slotted silica tube method gave 35 fold enhancement for Pb and 66 fold enhancement for Cd with respect to flame AAS technique [28].

1.3.3.5. SQT Atom Trap Method

Watling [31] firstly used SQT for increasing the analytical sensitivity of various elements in 1977. In his study, sufficient improvement has been observed for some elements even at very low concentration levels.

The SQT is a hollow quartz tube with two slots that have 120° or 180° angle between each others. The tube is placed on the head of the burner.

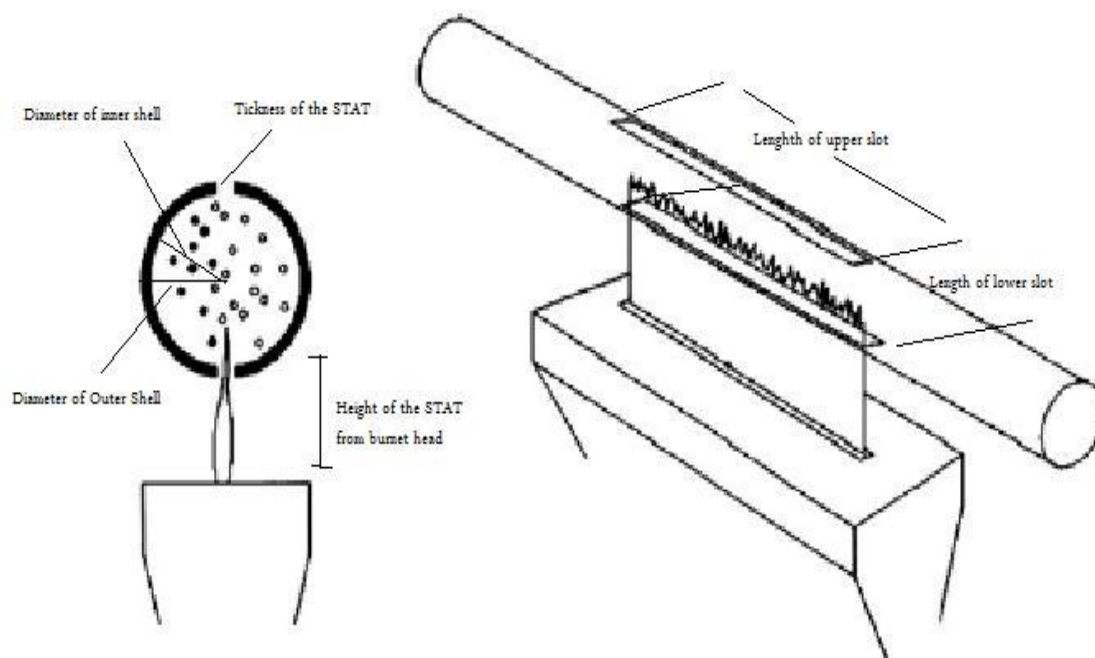

Figure 1.5 Different profile images of slotted quartz tube, SQT [9].

The sensitivity improvement takes place via rising the residence period of species in measurement zone by slowing the flame conditions and shortening the length of optical path through which atoms pass in the method. In the system, the chemical ambience in the tube will be steadier because of isolation of the flame from air.

SQT increases the sensitivity and the precision compared to other conventional flame method as well as potential interferences are also decreased due to dilution of the sample. This method is simple, rapid and inexpensive, and also SQT can be easily manufactured. The only major disadvantage of SQT is the limited of the system to volatile element determination.

The main steps of method are as follows;

- i) **Collection;** by using an optimized lean flame, sample solution is introduced into the flame to trap the analyte species in the inner walls of SQT [32].
- ii) **Revolatilization;** 10-50 μL of an organic solvent, like MIBK or MEK, is introduced into the flame in order to alter the flame composition for a very short period of time which helps analyte atoms to be released from the inner surface of SQT.
- iii) **Atomization;** after revolatilization, analyte atoms that are trapped in SQT are rapidly atomized and a transient signal is obtained.

The most important advantage of SQT-AT is the sufficient increase in sensitivity and the decrease in possible interferences due to dilution of samples. The main disadvantage of the method is the limited application that is only for volatile elements. Volatile elements easily decompose thermally in the primary reaction zone of air-acetylene flame [33].

Kumser has studied the determination of Bi, Au and Mn by using water cooled U-tube and uncoated FAAS-SQT-AT. Sensitivities for Bi, Au and Mn as compared to FAAS were improved 94, 180 and 6.6 folds, respectively [34]. Arı has examined Tl analysis by Os-coated SQT-AT and got 3.5 times sensitivity improvement relative to uncoated SQT-AT, overall sensitivity improvement relative to FAAS was 319 times by using a sample of 25 mL collecting in 5.0 minutes [35]. Demirtaş has determined Pb via Ta-coated SQT-AT and received 2.3 times improvement of sensitivity compared to uncoated SQT-AT [36]. Özcan Gurbetoğlu has also determined Cd by Zr-coated SQT-AT and got 1.6 times sensitivity improvement with respect to uncoated SQT-AT [37].

1.4. Atomization in FAAS-SQT-AT

Atomization has an important role for performance of SQT-AT. There are two different kinds of atomization technique used in atom traps which are flame alteration technique (FA) and organic solvent aspiration (OSA) techniques.

1.4.1. Flame Alteration Technique

Flame alteration technique based on changing the composition of flame by altering the air to acetylene ratio via introducing an extra flow of acetylene in order to obtain momentarily hotter and reducing flame. When this reducing flame contacts with silica surface, revolatilization and rapid atomization takes place and signal has obtained.

In a study on the determination of lead and cadmium using SQT-AT with FA and OSA techniques, no significant difference between these two techniques has been reported [34].

1.4.2. Organic Solvent Aspiration Technique

As it is formerly explained, organic solvent aspiration based on changing the composition of flame in a short period via aspirating a few microliters of solvent by the nebulizer. For this purpose, different sorts of organic solvent may be applied like methylisobutylketone (MIBK), acetonitrile, methylethylketone, iso-octane, n-hexane and acetone. MIBK and MEK were the most effective ones among these organic solvents [34].

Volume of organic solvent is 10-50 μL and when uptake rate is about 6.0 mL/min, only about 500 ms is enough for introduction of 50 μL MIBK; therefore, so even if there is any rise in flame temperature this would be for a very short period of time [9].

1.5. Aim of the Study

The main purpose of this study is to develop a sensitive analytical method for determination of tellurium (IV and VI) by using FAAS-SQT-AT. The reason for using different oxidation state of Te is that it has different sensitivity for different oxidation states using flame AAS; it has been reported that in both the air-acetylene and nitrous oxide flames, the sensitivity of Te (IV) is significantly higher as compared to Te (VI) [38]. The similar behavior mentioned above has also been observed in another M.S. thesis study in our group [39]. An uncoated SQT device with two slots with an angle of 180° with respect to each other is used for sensitivity improvement in the initial stages of research. Then, different materials have been applied to modify the surface of SQT and sensitivity comparisons were made. All parameters of uncoated and coated SQTAT were optimized. In addition, interference studies were carried out.

CHAPTER 2

EXPERIMENTAL

2.1. Apparatus and Materials

A 15 cm long slotted quartz tube with two slots positioned at 180° with respect to each other was used; length of the lower slot was 100 mm and the upper slot was 80 mm; inner diameter of the tube was 13 mm and the outer diameter was 17 mm. The slotted quartz tubes were prepared by the Glass Shop of Chemistry Department, METU.

Standard solutions were prepared by 100-1000 μL and 500-5000 μL Eppendorf micropipettes in glass containers with using a volume of 100 mL. Polyethylene containers with the capacity of 100 mL were used to store the solutions which were kept in refrigerator.

2.2. Chemicals and Reagents

Standard solution of 1000 mg/L tellurium standard ICP solution (Fisher Scientific International Company), 1000 mg/L Tellurium (IV) standard ICP solution and 989 mg/L Tellurium (VI) standard ICP solution were used for the preparation of working solutions. Intermediate standard solutions of Te (IV) and Te (VI) were prepared by diluting necessary volumes of 1000 mg/L standard solution with deionized water. Dilutions were made using 18 M Ω -cm deionized water obtained from a Millipore (Molsheim, France) Milli-Q water purification system which was fed using the water produced by Millipore Elix 5 electro deionization system.

All the glass and polyethylene containers were cleaned in 10% (v/v) HNO₃ by immersing them for at least overnight. Cleaned materials were then washed with deionized water before use.

For the interference study, three types of solutions were arranged in which of Te (VI) and Te (IV) concentrations were constant as 100.0 ng/mL, and the interferent concentrations were 1, 10, and 100 folds in mass of the analyte concentration. Sodium, Magnesium, Calcium, Iron, Copper, Aluminum, and Arsenic were prepared by 1000 mg/L stock solutions in 1.0 M HNO₃. Selenium and Antimony are prepared from selenium dioxide and potassium antimony tartarate solids.

2.3. Atomic Absorption Spectrometer

Unicam 929 AAS with a D₂ background corrector was employed. The results were saved using the SOLAAR software of the AA instrument. Air/acetylene flame type has been utilized with 10.0 mm burner head. Varian Te HCL has been used respectively as a radiation source. All the analyses were done at the wavelength of 214.3 nm for Te and a spectral band pass of 0.5 nm for Te. The operating conditions of Te for the FAAS are shown in Table 2.1.

Table 2.1 Operating Conditions for FAAS

Flame Type	Air-Acetylene
Wavelength of Te, nm	214.3
Hollow Cathode Lamp Current, mA	7.0
Spectral Band Pass, nm	0.5
Air Flow Rate, L/min	2.7
Acetylene Flow Rate, L/min	0.5-1.2

2.4. Coating Procedure of SQT

For the coating SQT, 100 mL of 100 mg/L solutions of Palladium, Tantalum, Zirconium, Titanium, Osmium and Molybdenum has been arranged by solids, $K_2[PdCl_6]$, Ta_2O_5 , $Zr(NO_3)_4 \cdot 5H_2O$, and Mo metal; all coatings except W were obtained by aspirating of coating solution in 4.0 mL/min of a lean flame while the slotted quartz tube was positioned as usual. W coated SQT was already available in the laboratory, it was prepared by aspirating 100 mL of 1000 mg/L W solution using a suction rate of 3.4 mL/min, in the presence of a lean flame. In the interference applications, some elements damaged the coated surface, so damaged SQT was kept in 15 % (v/v) of HF solution for ten to fifteen minutes, then recoated with the same procedure of coating.

Procedures for the metal coating solutions are as follows:

- i. $K_2[PdCl_6]$ was dissolved in water.
- ii. $K_2[OsCl_6]$ was dissolved in water.
- iii. Ta_2O_5 was dissolved in % 2 HF solution.
- iv. $Zr(NO_3)_4 \cdot 5H_2O$ was dissolved in water.
- v. TiO_2 was dissolved in hot concentrated H_2SO_4 .
- vi. Mo metal was dissolved in 1.5 M hot HNO_3 solution.

CHAPTER 3

RESULTS AND DISCUSSION

A sensitive method for tellurium (IV) and tellurium (VI) determination is developed in this study which consists of four stages. The sequences of the steps are as follows;

- i. The determination of tellurium by simple FAAS.
- ii. Use of a SQT for the sensitivity improvement by rising the dwelling period of species in measurement zone. SQT-FAAS was used as an acronym for this stage of study.
- iii. The atom trap studies with uncoated SQT via preconcentration. The acronym used for this purpose is SQT-AT-FAAS.
- iv. The last step is the further improvement of sensitivity by coating of SQT device using a metal (M), 180° angled tube configuration was used. Variety of coating materials was used for this aim. This method is called M-coated SQT-AT-FAAS.

Main interest of the work is focused on the improvement of the trapping methods. Trap techniques depend on the total mass of analyte and also trapping period. While the trap time raises the overall trapping amount of species raises. Then it seems that there is a sensitivity improvement, but this should be evaluated together with the time involved. Sensitivity enhancement, E , can be used at this point. Ataman [9] introduced two new terms, enhancement factors in term of unit time, E_t , and unit volume, E_v . First, characteristic concentration, C_0 , concentration that corresponds to 0.00436 absorbance (1% absorption); has to be calculated;

$$C_0 = 0.00436 \times (\text{analyte concentration/absorbance}).$$

Then, by comparison of the C_0 values, sensitivity improvement is obtained. Sensitivity improvement can also be obtained by comparing calibration slopes.

E_t is the ratio of E to total time spend (minutes), and E_v is the ratio of E to total volume spend (milliliters). Therefore, it would be possible to make a more reasonable comparison between two techniques by considering the trap time and the volume of sample solution. In order to evaluate the trapping efficiency another term is used; characteristic mass, m_0 , is the mass of analyte which produces a defined peak that has an absorbance value of 0.00436 (or 1 % absorption). In addition to sensitivity enhancement, limit of detection (LOD) is found as $3s/m$, limit of quantization (LOQ) is found as $10s/m$ for each method.

3.1. FAAS Study for Tellurium

In the first step, Te was determined by simple FAAS technique without any SQT device. For having higher S/N ratio, acetylene (AFR) and sample flow rates (SFR) were optimized. For optimizations, 10.0 mg/L Te (VI) standard solution was used.

3.1.1. Optimization of Flow Rate of Acetylene

In this optimization only acetylene flow has changed by taking air (AirFR) and sample flows constantly as indicated in below mentioned figures. Tellurium determination by FAAS requires a stoichiometric flame, and as indicated in Figure 3.1 increasing fuel flow rate does not cause an important change in absorbance and also at higher flow rates the flame stability is poor; therefore 1.2 L/min is selected for acetylene.

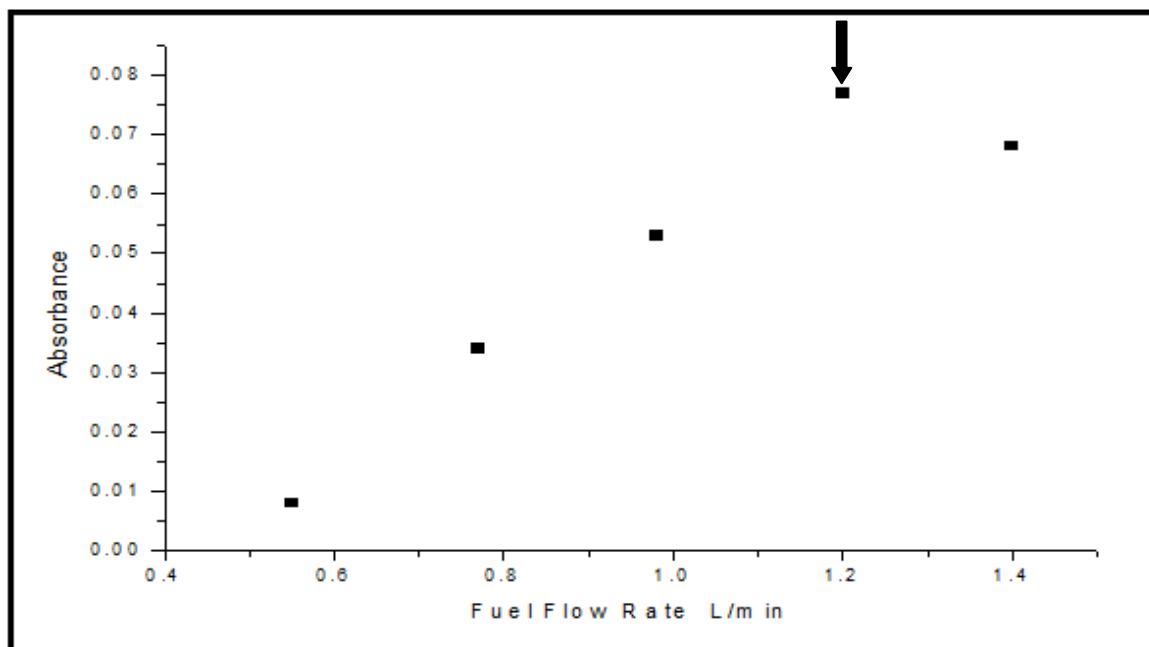

Figure 3.1 Acetylene flow rate for 10.0 mg/L Te (VI) in FAAS. AFR: 2.7 L/min, SFR: 6.00 mL/min

3.1.2. Optimization of Sample Suction Rate

The sample flow rate has changed by alteration of suction rate of nebulizer. Sample suction rate was optimized with 10.0 mg/L Te (VI) at a 2.7 L/min air and 1.2 L/min acetylene flow rates. Result of the optimization was shown in Figure 3.2. At higher suction rates, better signal was obtained due to the increased population of analyte atoms per unit time in measurement zone. It is observed that 6.00 mL/min is the optimized SFR for Te (VI).

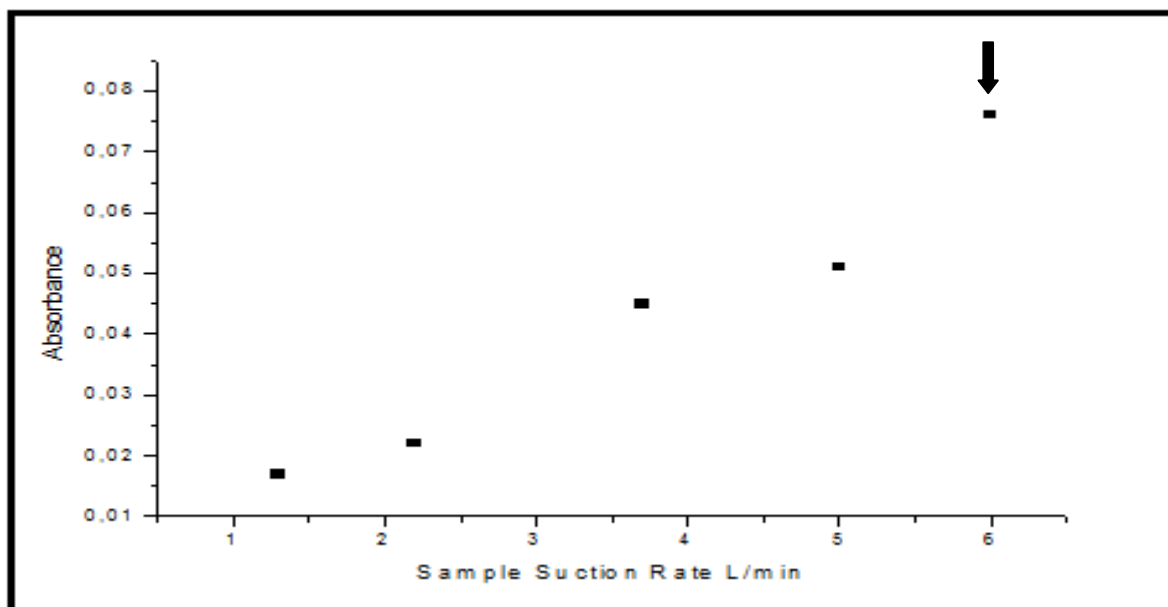

Figure 3.2 Optimized SFR for 10.0 mg/L Te (VI) in FAAS. AFR: 1.2 L/min, AirFR: 2.7 L/min,

3.1.3. Calibration Plot for Te (VI) in FAAS

For the optimum conditions that are decided in former experiments, absorbance values of tellurium (VI) solutions in concentrations between 2.0-200.0 mg/L were measured (Figure 3.3). Calibration plot was linear between 2.0-100.0 mg/L (Figure 3.4). The most suitable linear equation (LE) and correlation coefficient (CC) were, $y = 0.00531x + 0.0118$ and 0.9956 respectively.

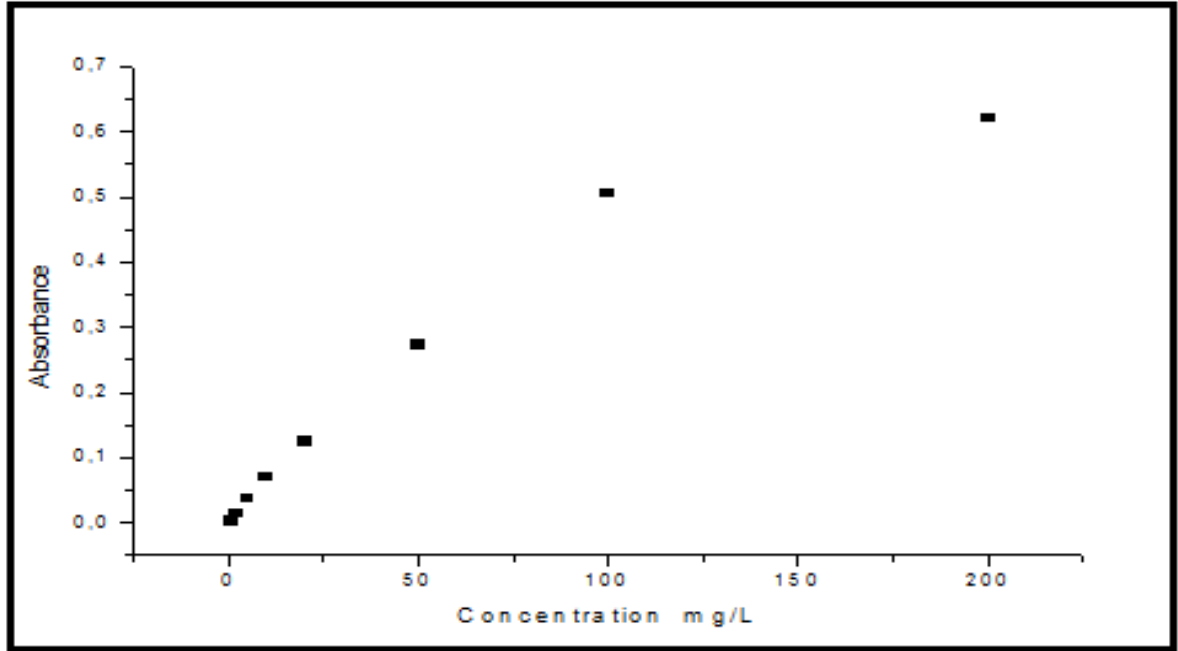

Figure 3.3 Calibration plot for Te (VI) in FAAS method

AFR: 1.2 L/min, AirFR: 2.7 L/min, SFR: 6.00 mL/min

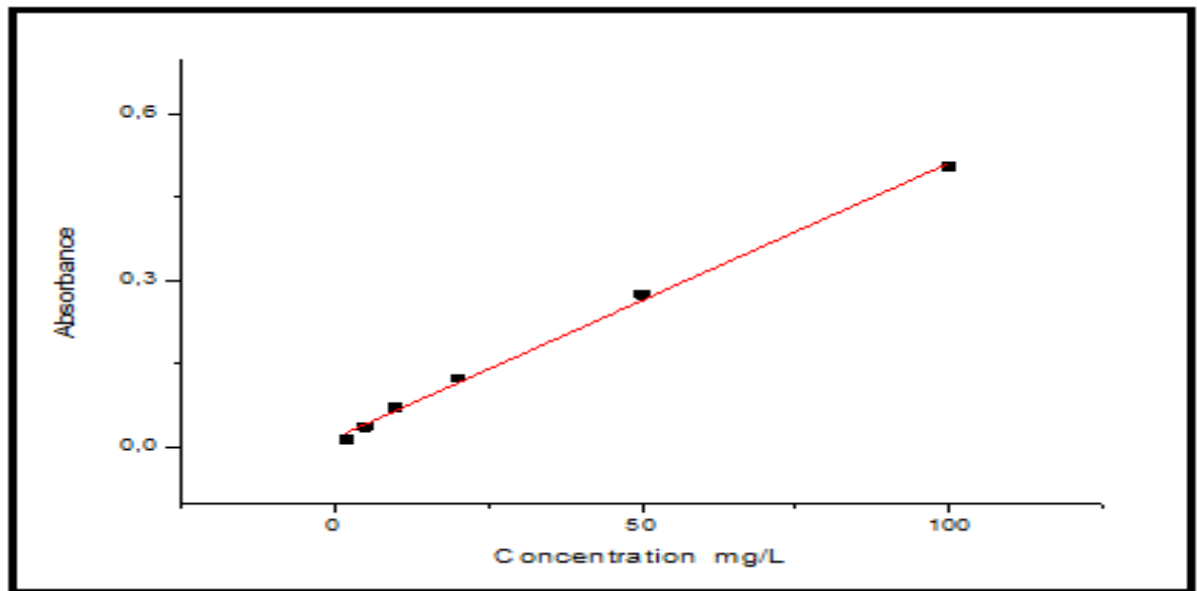

Figure 3.4 Linear calibration plot for Te (VI) in FAAS method

AFR: 1.2 L/min, AirFR: 2.7 L/min, SFR: 6.00 mL/min

As indicated in the Table 3.1., limit of detection and limit of quantization values for Te (VI) were calculated as 0.55×10^3 ng/mL and 1.9×10^3 ng/mL respectively. Characteristic concentration (C_0) was estimated as 0.623×10^3 ng/mL. For LOD and LOQ determination 11 measurements of 2.0 mg/L solution were used.

Table 3.1 Analytical Performance with FAAS for Te (VI)

Linear Range, mg/L	2.0-100.0
Limit of Detection (LOD), ng/mL	0.55×10^3
Limit of Quantitation (LOQ), ng/mL	1.9×10^3
Characteristic Concentration (C_0), ng/mL	0.623×10^3

3.1.4. Calibration Plot for Te (IV) in FAAS Method

For the optimum conditions that are decided in former experiments, absorbance values of tellurium (IV) solutions in concentrations between 2.0-200.0 mg/L were also measured (Figure 3.5). Calibration plot was linear between 2.0-100.0 mg/L (Figure 3.6). The LE and CC were obtained as $y = 0.00483x + 0.00869$ and 0.9987 respectively.

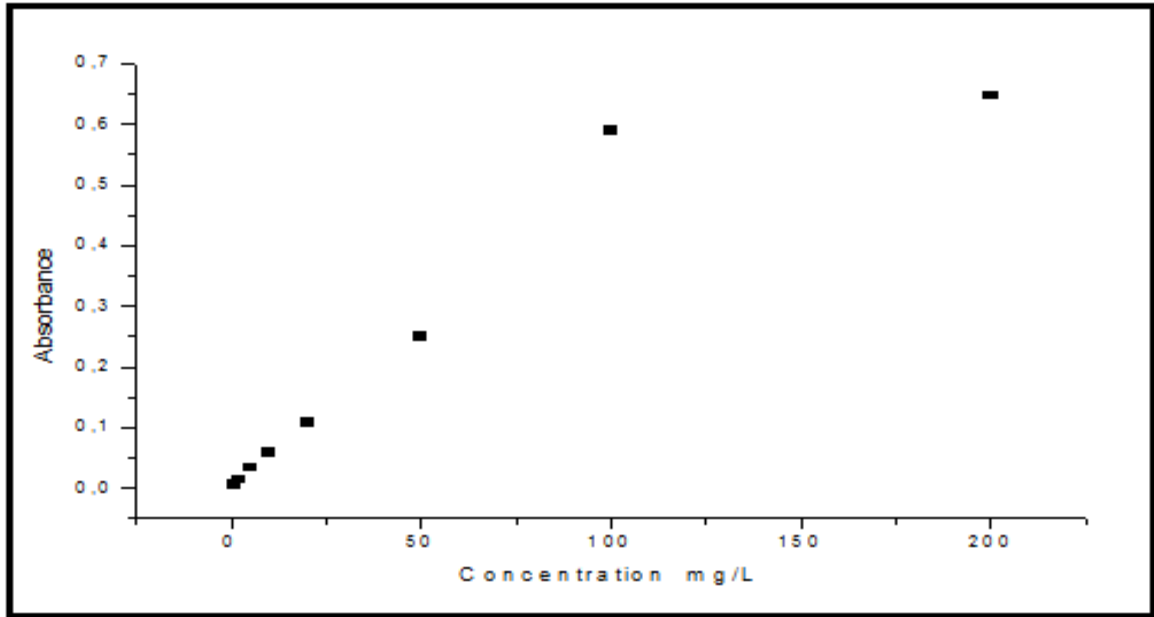

Figure 3.5 Calibration plot for Te (IV) in FAAS method

AFR: 1.2 L/min, AirFR: 2.7 L/min, SFR: 6.00 mL/min

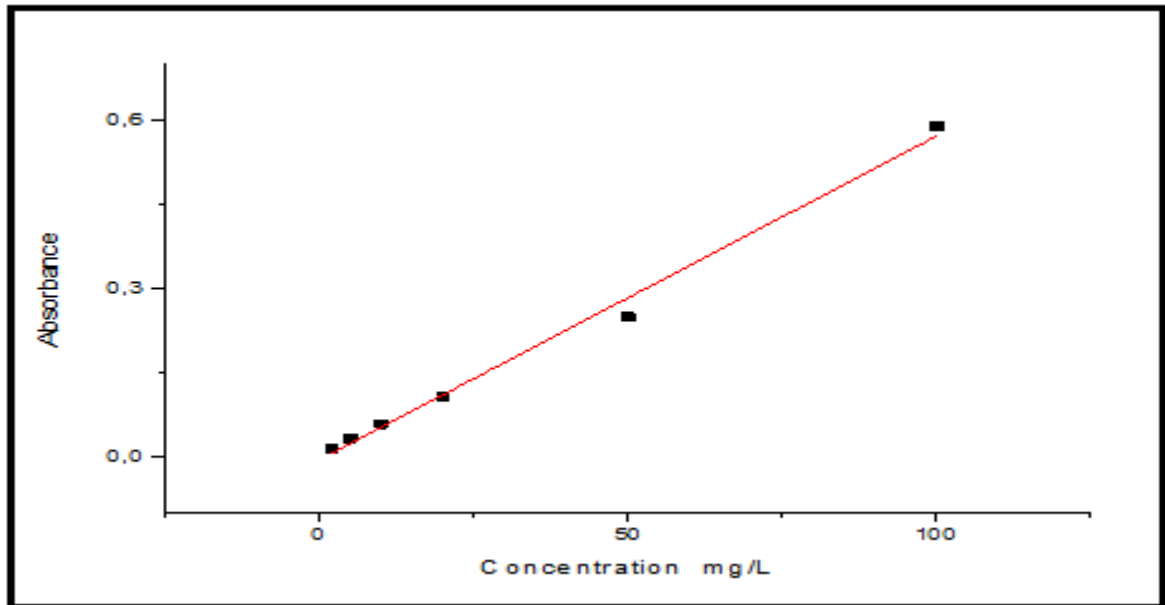

Figure 3.6 Linear calibration plot for Te (IV) in FAAS method

AFR: 1.2 L/min, AirFR: 2.7 L/min, SFR: 6.00 mL/min

As indicated in the Table 3.2., limit of detection and limit of quantization values for Te (IV) were calculated as 0.49×10^3 ng/mL and 1.6×10^3 ng/mL respectively. Characteristic concentration (C_0) was estimated as 0.671×10^3 ng/mL. For LOD and LOQ determination 11 measurements of 2.0 mg/L solution were used.

Table 3.2 Analytical Performance with FAAS for Te (IV)

Linear Range, mg/L	2.0-100.0
Limit of Detection (LOD), ng/mL	0.49×10^3
Limit of Quantitation (LOQ), ng/mL	1.6×10^3
Characteristic Concentration (C_0), ng/mL	0.671×10^3

3.2. SQT - FAAS Method for Tellurium

In this step, sensitivity of tellurium was enhanced by positioning the SQT on the burner head in order to rise the residence period which allows the entire light beam pass through the quartz tube. The FFR, SFR and distance between SQT and the burner head (DSQT) were optimized. 10.0 mg/L Te (VI) solution was used throughout optimizing parameters.

3.2.1. Optimization of AFR

The optimum AFR was found as 0.66 L/min as seen in Figure 3.7.

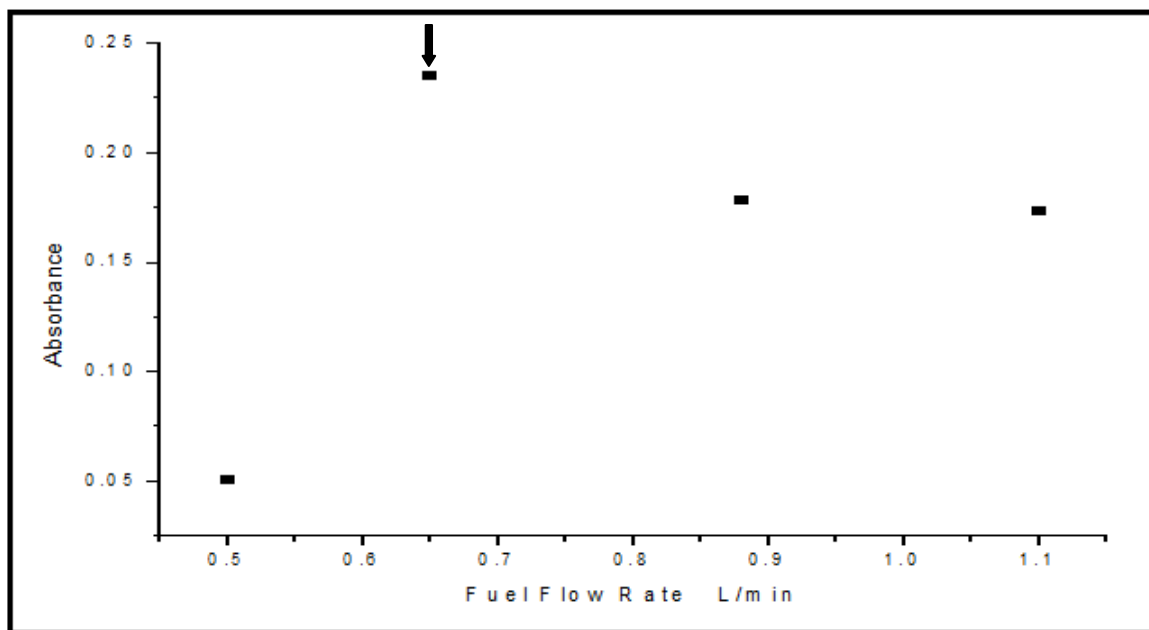

Figure 3.7 Optimization of AFR for 10.0 mg/L Te (VI) in SQT-FAAS.

SFR: 6.0 mL/min, AirFR: 2.7 L/min, DSQT: 1.0 mm

3.2.2. Optimization of SFR

As indicated at Figure 3.8, increasing suction rate of sample causes analyte signal to rise with the same reason as in FAAS study, because of the rise of the population of analyte species per unit time inside flame. Optimum SFR for Te (VI) solution was determined as 6.0 mL/min in 180° angled SQT-FAAS method.

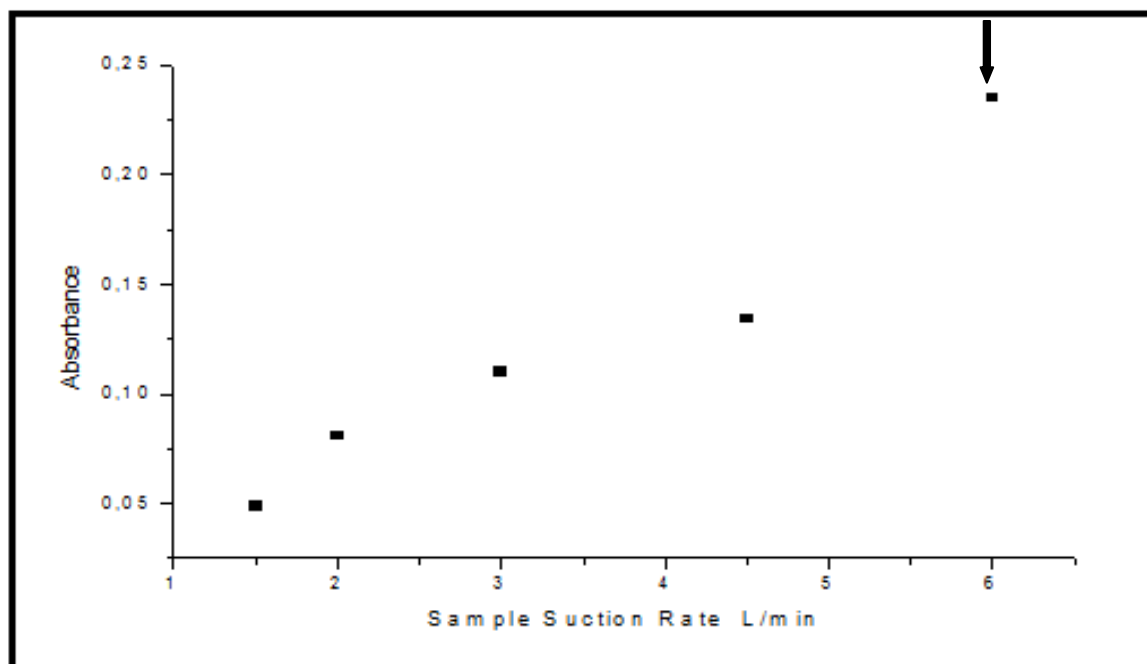

Figure 3.8 Optimization of SFR for 10.0 mg/L Te (VI) in SQT-FAAS.

AFR: 0.6 L/min, AirFR: 2.7 L/min, DSQT: 1.0 mm

3.2.3. Optimization of DSQT

DSQT is also a key parameter that was optimized. As shown in Figure 3.9, 1.0 mm, among 1.0 to 4.0 mm distances, was found as the optimum height for 180° angled SQT-FAAS method. While optimizing the height, it should be considered as short as possible for entering of analyte atoms into the tube.

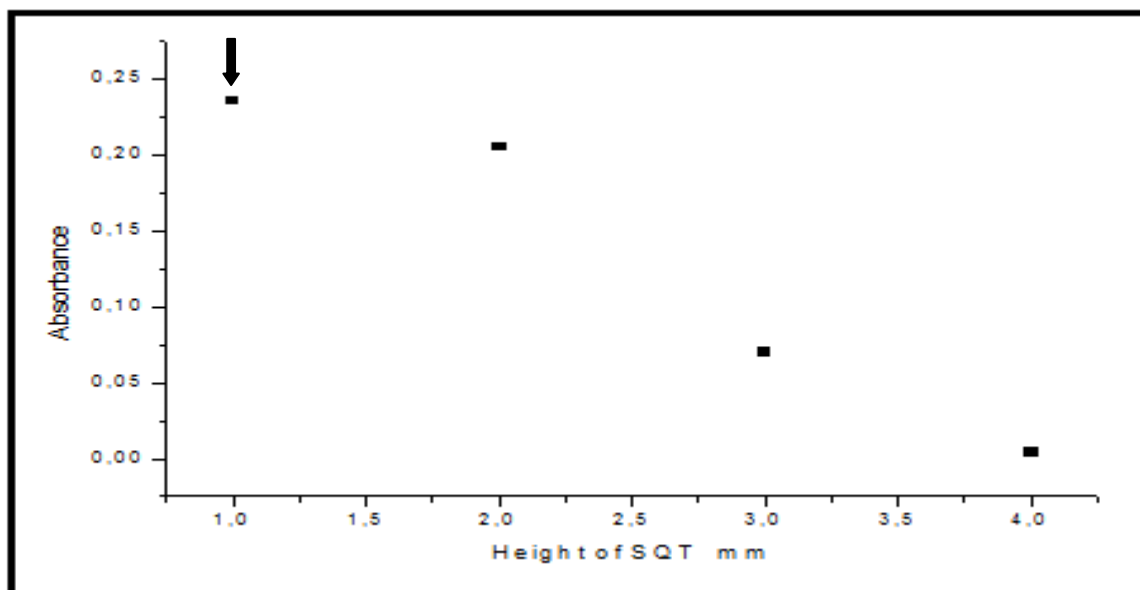

Figure 3.9 Optimization of DSQT for 10.0 mg/L Te (VI) in SQT-FAAS.
 AFR: 0.66 L/min, Air FR: 2.7 L/min, SFR: 6.0 mL/min.

3.2.4. Calibration Plots for Te (VI) in SQT-FAAS Method

For calibration plot obtained from 180° angled SQT, Te (VI) solutions between 1.0-200.0 mg/L solutions were used (Figure 3.10), calibration plot is linear between 1.0-20.0 mg/L. The LE and CC were obtained as, $y = 0.01953x + 0.02956$ and 0.9866, respectively (Figure 3.11).

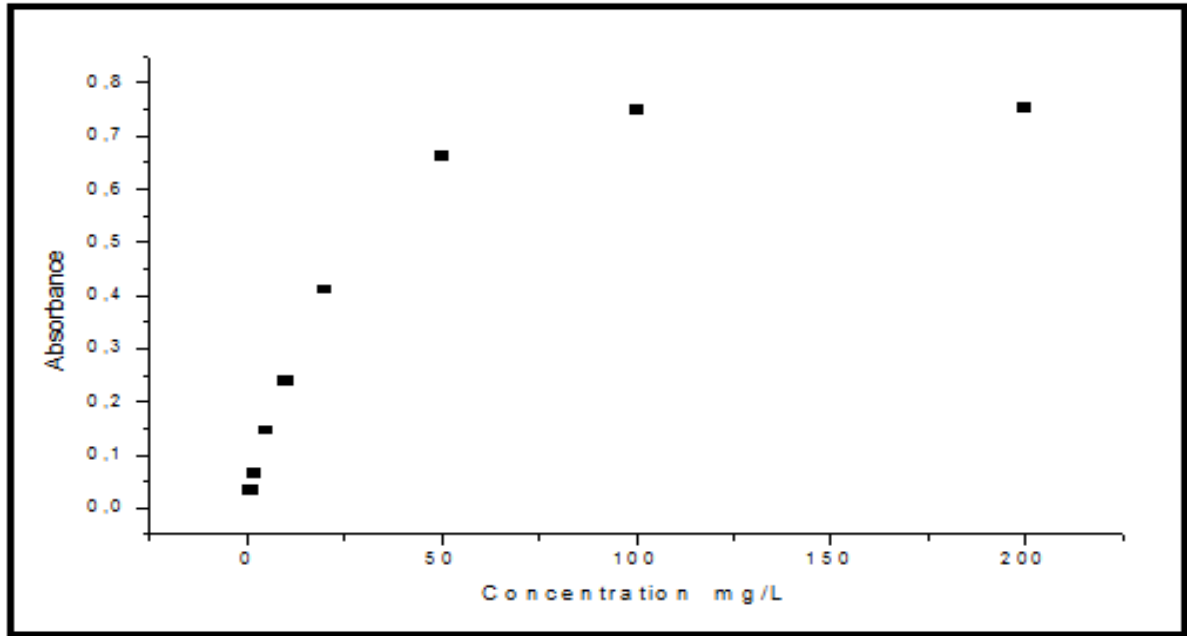

Figure 3.10 Calibration plot for Te (VI) in SQT-FAAS method
 AFR: 0.66 L/min, Air FR: 2.7 L/min, SFR: 6.0 mL/min, DSQT: 1.0 mm

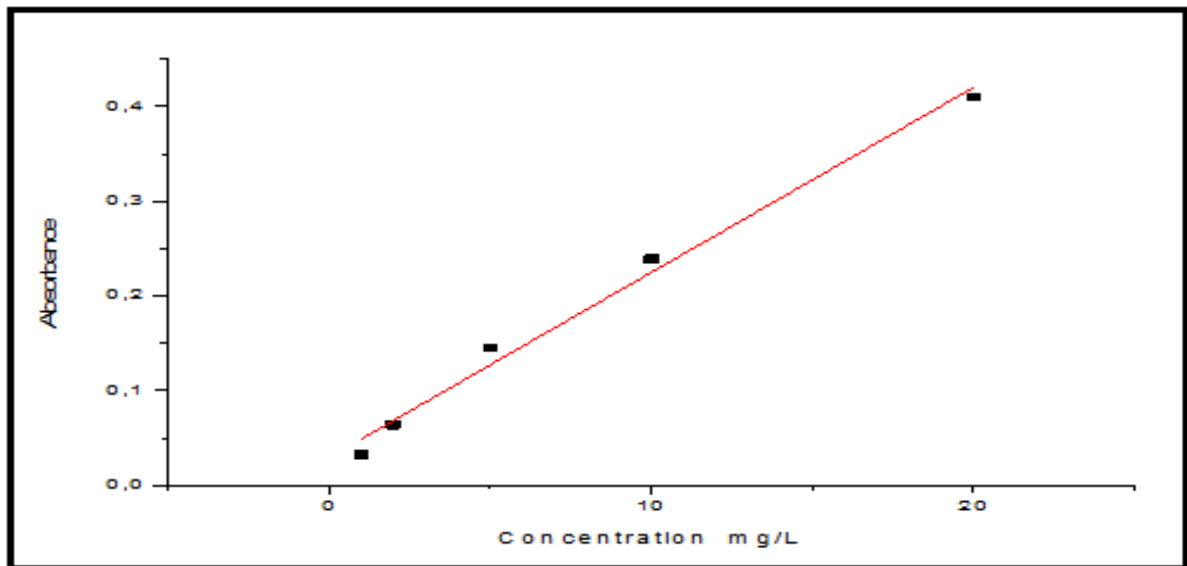

Figure 3.11 Linear calibration plot for Te (VI) 180° angled SQT-FAAS method
 AFR: 0.66 L/min, AirFR: 2.7 L/min, SFR: 6.0 mL/min, DSQT: 1.0 mm

For 180° angled SQT, as indicated at Table 3.3., limit of detection and limit of quantization values for Te (VI) were calculated as 0.20×10^3 ng/mL and 0.67×10^3 ng/mL respectively and characteristic concentration was estimated as 0.194×10^3 ng/mL. Enhancement factor compared to FAAS was 3.2. For LOD and LOQ determination 11 measurements of 1.0 mg/L solution were taken.

Table 3.3 Analytical Performance of Te (VI) for SQT-FAAS

	180°Angled SQT
Linear Range,mg/L	1.0-20.0
Limit of Detection (LOD), ng/mL	0.20×10^3
Limit of Quantitation (LOQ), ng/mL	0.67×10^3
Characteristic Concentration (C₀), ng/mL	0.194×10^3
Enhancement (E) <i>(with respect to FAAS)</i>	3.2

3.2.5. Calibration Plots for Te (IV) in SQT-FAAS Method

For calibration plot obtained from 180° angled SQT, Te (IV) solutions between 1.0-200.0 mg/L solutions were used (Figure 3.12), calibration plot is linear between 1.0-20.0 mg/L. The LE and CC were obtained as $y = 0.01552x + 0.02325$ and 0.9839, respectively (Figure 3.13).

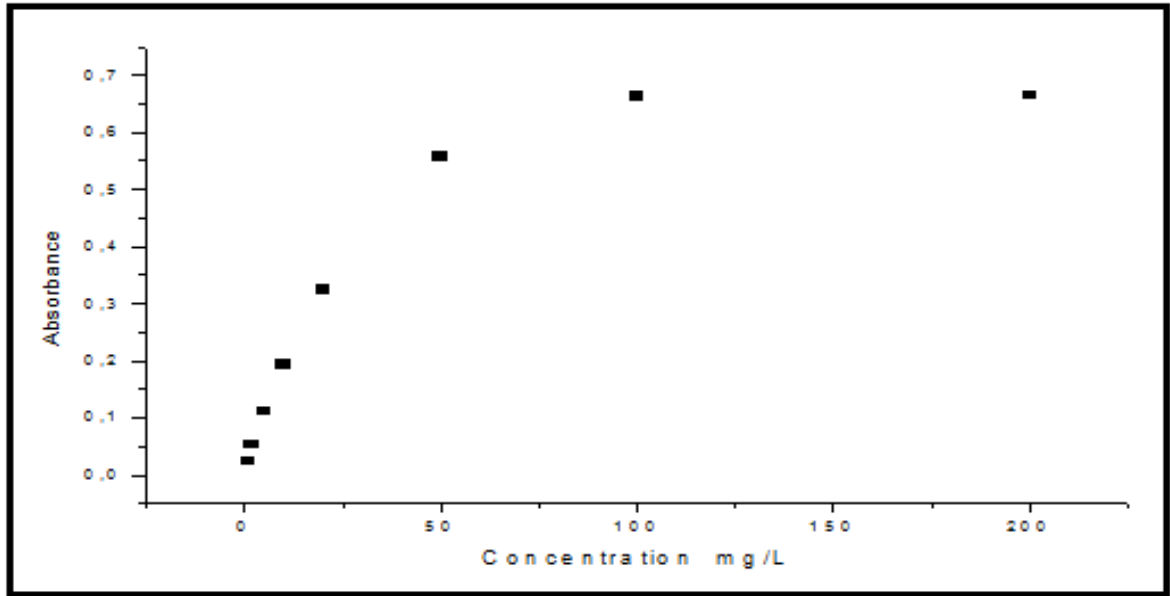

Figure 3.12 Calibration plot for Te (IV) in 180° angled SQT-FAAS method

AFR: 0.66 L/min, AirFR: 2.7 L/min, SFR: 6.0 mL/min, DSQT: 1.0 mm

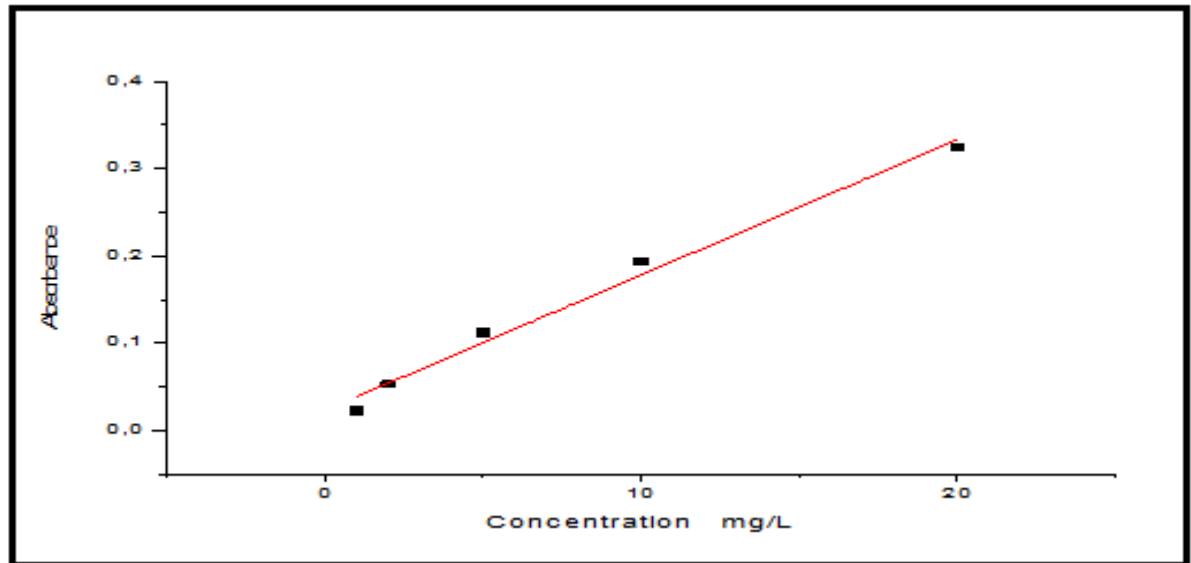

Figure 3.13 Linear calibration plot for Te (IV) in 180° angled SQT-FAAS method

AFR: 0.66 L/min, Air FR: 2.7 L/min, SFR: 6.0 mL/min, DSQT: 1.0 mm

For 180° angled SQT, as indicated at Table 3.4., limit of detection and limit of quantization values for Te (IV) were calculated as 0.18×10^3 ng/mL and 0.60×10^3 and the characteristic concentration was estimated as 0.208×10^3 ng/mL. Enhancement factor compared to FAAS was 3.2. For LOD and LOQ determination 11 measurements of 1.0 mg/L solution were taken.

Table 3.4 Analytical Performance of Te (IV) for SQT-FAAS

	180° Angled SQT
Linear Range,mg/L	1.0-20.0
Limit of Detection (LOD), ng/mL	0.18×10^3
Limit of Quantitation (LOQ), ng/mL	0.60×10^3
Characteristic Concentration (C₀), ng/mL	0.208×10^3
Enhancement (E) <i>(with respect to FAAS)</i>	3.2

3.3. SQT-AT-FAAS Method for Tellurium

SQT has been utilized as an atom trap device in the same way by placing on the burner head as in the previous study (SQT-FAAS). Tellurium solution was aspirated for a certain time into the flame with a very lean flame condition for collecting analyte atoms on inner surface of the tube. After collection, atomized species were liberated by aspirating small volume of organic solvent that will also be optimized, and a transient signal was obtained.

3.3.1. Effect of Organic Solvent

For rapidly and effectively revolatilizing the analyte species, a highly flammable organic solvent is needed. In order to find the optimum revolatilization conditions, several types of organic solvents were used, such as MIBK, MEK, acetonitrile, isopropylalcohol,

methyl alcohol, ethyl alcohol, cyclo-pentanol and butanol. Performance of each solvent was shown in Table 3.5. Tellurium signals obtained by using MIBK and MEK are close to each other, but the signal obtained by MIBK was not as stable as signal obtained by MEK. As a solvent, MEK was chosen.

Table 3.5 Effect of Organic Solvents on Te Signals for SQT-AT-FAAS Method

Type of organic solvent	Absorbance (180° angled SQT)
MIBK	0.146
→ MEK	0.154
Isopropyl alcohol	No Signal
Methanol	No Signal
Ethanol	No Signal
Cyclopentanol	No Signal
N-butanol	No Signal
Acetonitrile	No Signal

Concentration of Te (VI): 250.0 ng/mL, AFR: 0.5 L/min, Air FR: 2.7 L/min, SFR: 6.0 mL/min, DSQT: 1.0 mm, Volume of organic solvent (VOS): 45 µL, Trapping period (TP): 4.0 min

In Table 3.6 chemical formulas and flash points of organics used for volatilization step of Te are given. It could be expected that the performance of organics with low flash points would be high. However, as seen in Table 3.5 this factor was not found to be important. It could be related with carbon order structure of the molecule.

Table 3.6 Molecular Formulas and Flash Points of Organics used for revolatilization of Te

Type of Organic solvent	Molecular Formula	Flash Point [44]
MIBK	C ₆ H ₁₂ O	14°C
MEK	C ₄ H ₈ O	-9°C
Acetonitrile	C ₂ H ₃ N	2°C
Methanol	CH ₄ O	11°C
Isopropyl alcohol	C ₃ H ₈ O	12°C
Ethanol	C ₂ H ₆ O	13°C
N-butanol	C ₄ H ₁₀ O	37°C
Cyclopentanol	C ₅ H ₁₀ O	93°C

3.3.2. Optimization of VOS

After choosing the proper organic solvent for revolatilization, volume of organic solvent (VOS) was also optimized. Small volume of organic solvents from 10 to 50 μ L is adequate for revolatilization of the trapped atoms; signals from different amounts of MEK were obtained. It was concluded that 45 μ L of MEK gave complete revolatilization of 250.0 ng/mL Te (VI) solution (Figure 3.14). Higher amount of organic solvent has not any impact effect for signal of tellurium. In addition, higher volume of organic solvent can damage the windows of instrument; because, after introduction of organic solvent, flame formed momentarily may extend outside through the end points of SQT and approaches to the windows of detector on both sides.

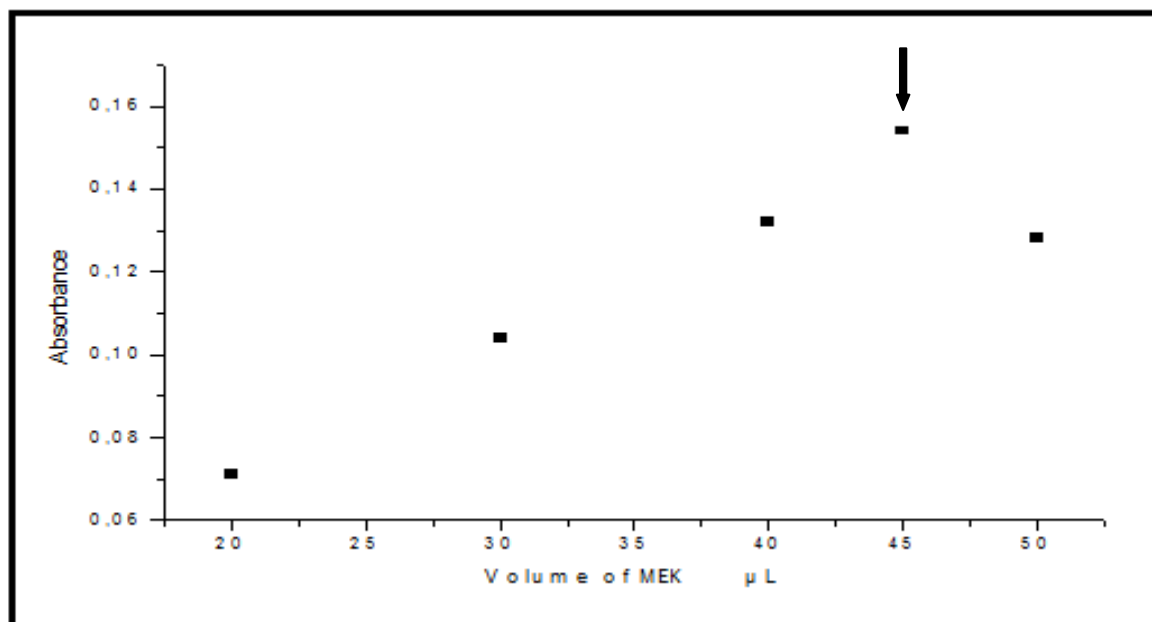

Figure 3.14 Optimization of volume of organic solvent using 250.0ng/mL Te (VI) in 180° angled SQT-AT-FAAS

AFR: 0.5 L/min, Air FR: 2.7 L/min, SFR: 6.0 mL/min, DSQT: 1.0 mm, Organic solvent (OS): MEK, TP: 4.0 min

3.3.3. Optimization of SFR

SFR is one of the most important parameter that should be optimized in trapping techniques since it affects nebulizing efficiency. In case of a rise in suction rate, results with fall of the efficiency of nebulization. However, the amount of species that are transported to the system increases, and in an optimum condition, nebulizing efficiency and amount of species in the system has maximum efficiency.

SFR also provides some alteration of flame properties in atomization step. Therefore, SFR has been optimized during these trapping methods. In order for sending equal amounts of analytes with various flow rates, 24 mL of 250.0 ng/mL Te (VI) solutions were used for optimizing suction rate. 6.0 mL/min was chosen as optimum suction rate as seen in Figure 3.15.

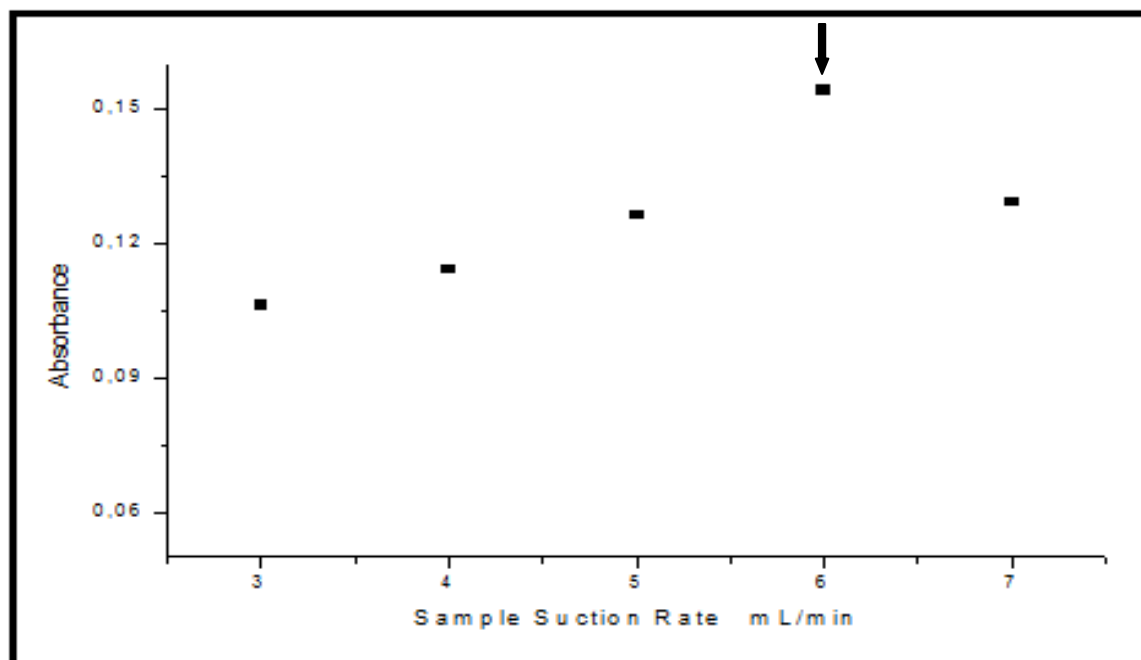

Figure 3.15 Optimization of SFR for 250.0 ng/mL, 24.0 mL Te (VI) in SQT-AT-FAAS. AFR: 0.5 L/min, Air FR: 2.7 L/min, DSQT: 1.0 mm, VOS: 45 μ L, OS: MEK, TP: 4.0 min

3.3.4. Optimization of AFR

AFR is also a significant key parameter that has been optimized. At stoichiometric or fuel rich flame, analyte species are atomized and removed out of measurement zone instead of trapping. Therefore, a lean flame is used to trap the species on the inside wall of slotted tube. Optimum AFR has been found as 0.5 L/min (Figure 3.16).

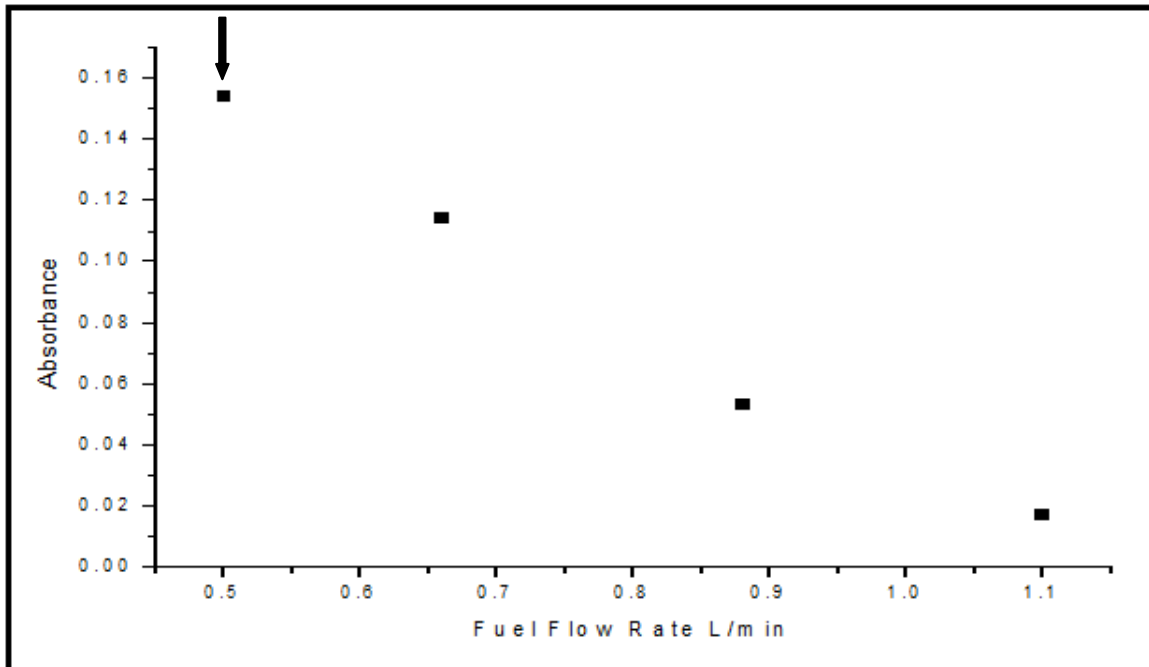

Figure 3.16 Optimization of AFR for 250.0 ng/mL Te in SQT-AT-FAAS

AirFR: 2.1 L/min, SFR: 6.0 mL/min, DSQT: 1.0 mm, OS: MEK, VOS: 45 μ L, TP: 4.0 min

3.3.5. Optimization of DSQT

In the previous study (SQT-FAAS) rise in the height causes the signal to be lower; because Te atoms cannot be efficiently transported into SQT. This is also valid in SQT-AT-FAAS. As seen in Figure 3.17 the optimum height is 1.0 mm.

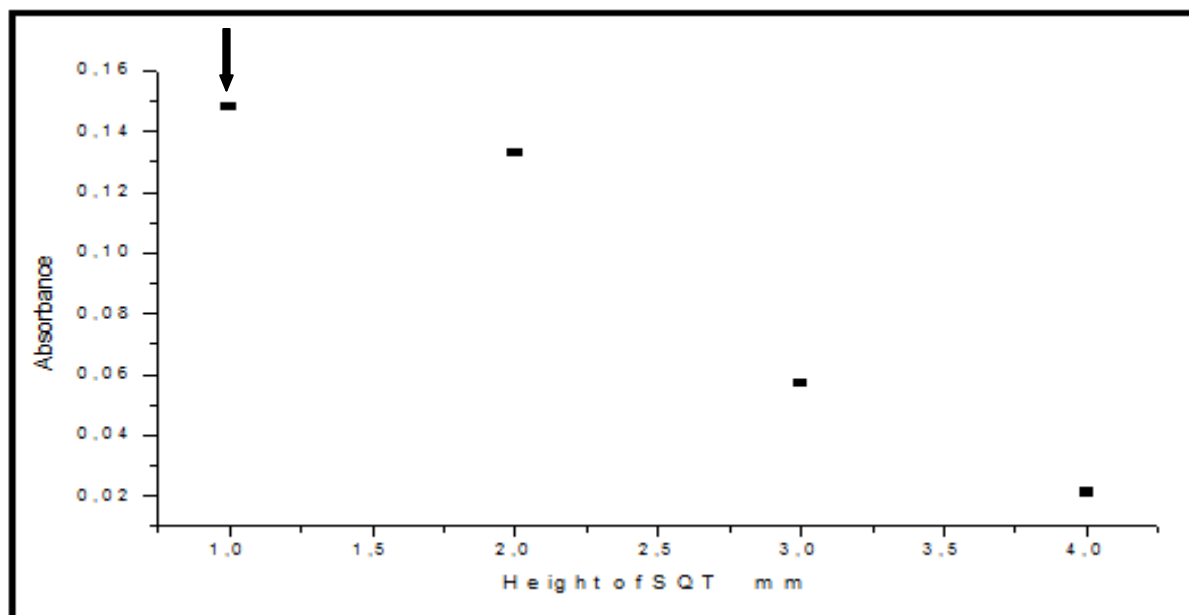

Figure 3.17 Optimization of height of SQT from the burner using 250.0 ng/mL Te in SQT-AT-FAAS

AFR: 0.5 L/min, AirFR: 3.5 L/min, SFR: 6.0 mL/min, TP: 4.0 min, VOS: 45 μ L, OS: MEK

3.3.6. Effect of Trapping Period

Enhancing the sensitivity is linearly relative to collection time of species; therefore, when the collection time rises, the sensitivity also raises. By the time, elongated time period is not always an advantage, because the overall performance and quality of the system depends also on the time of measurement which should be reasonable, therefore between the trapping periods of 2-7 minutes, 5.0 minutes of collection was chosen as optimized TP.

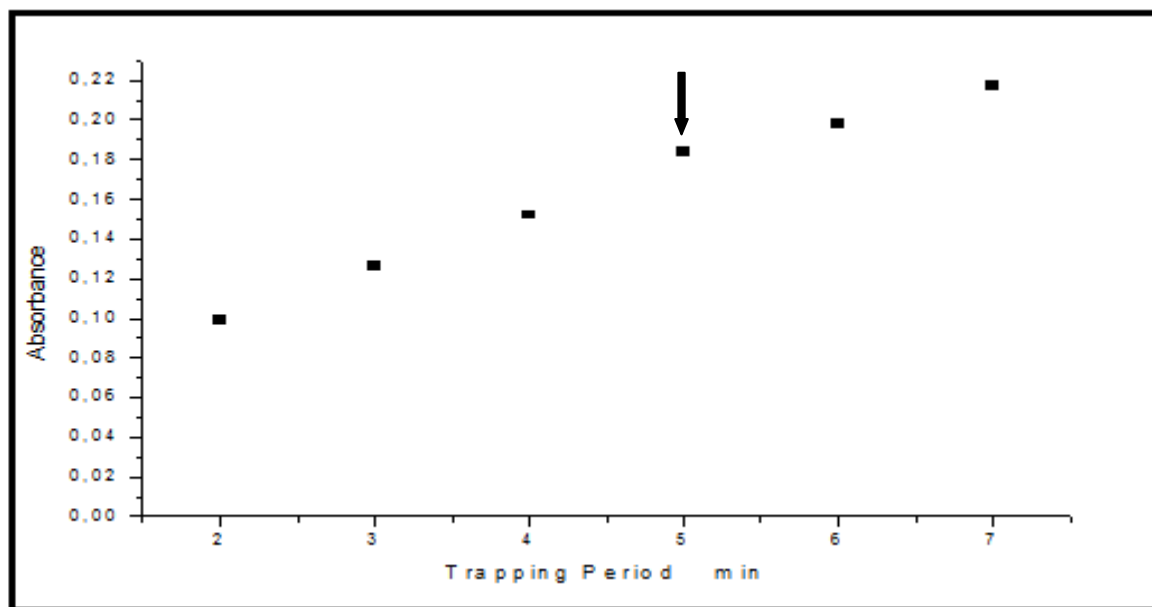

Figure 3.18 Effect of TP for 250.0 ng/mL of Te (VI) solution in SQT-AT-FAAS.

AFR: 0.5 L/min, AirFR: 2.7 L/min, SFR: 6.0 mL/min, DSQT: 1.0 mm, VOS: 45 μ L, Type of OS: MEK

Table 3.7 Conditions for SQT-AT-FAAS Method

Parameter	Condition
Type of Organic Solvent	MEK
Sample Suction Rate	6.0 mL/min
Volume of Organic Solvent	45 μ L
Trapping Period	5.0 min
Height of The SQT from the Head of the Burner	1.0 mm
Acetylene Flow Rate	0.5 L/min
Air Flow Rate	2.7 L/min

In the optimum parameters shown in Table 3.7, 250.0 ng/mL Te (VI) was transported to the system via a nebulizer and the signal has been obtained as seen in Figure 3.19.

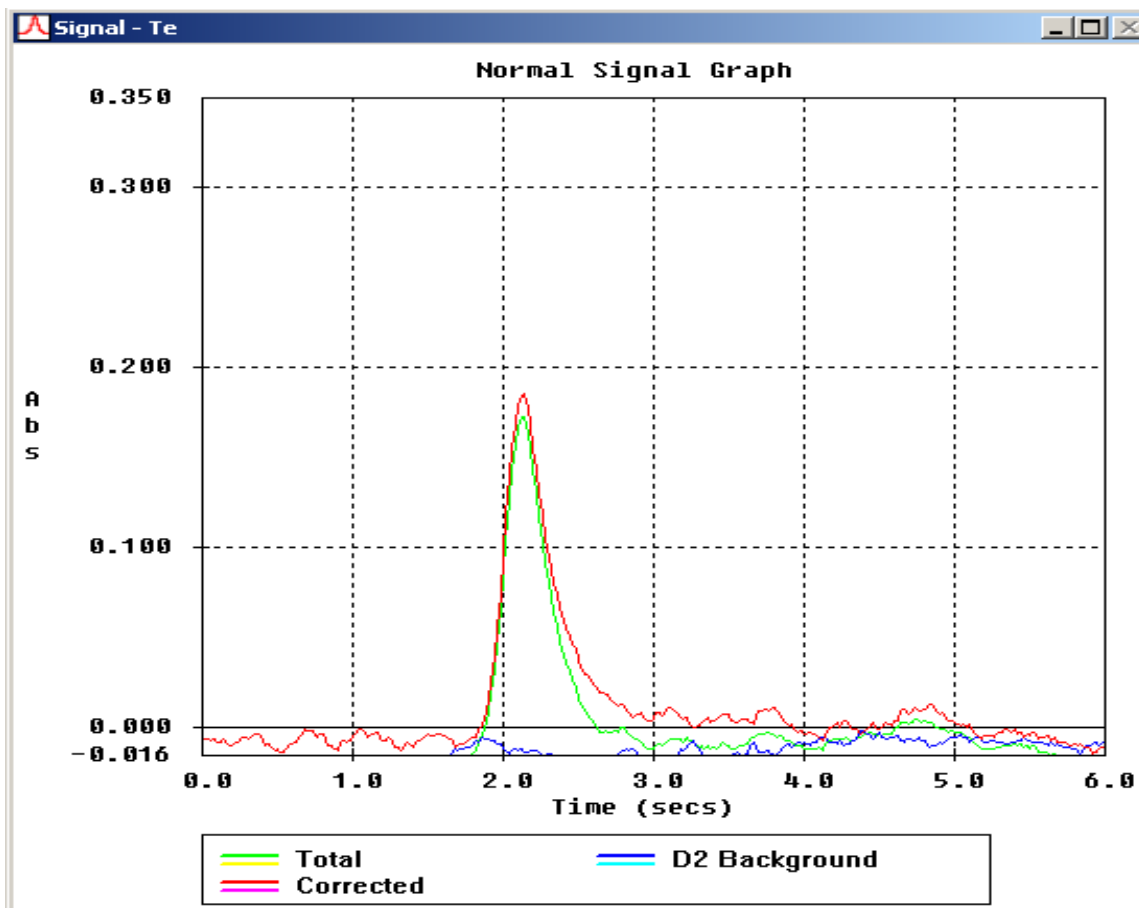

Figure 3.19 The signal of 250.0 ng/mL Te (VI) for SQT-AT-FAAS.

3.3.7. Calibration Plots for Te (VI) in SQT-AT-FAAS

After the optimization process, a calibration plot was graphed in a standard range of 25.0-2000.0 ng/mL Te (VI) (Figure 3.20). The linear calibration plot was attained for the 25.0-500.0 ng/mL of Te (VI). As can be seen from Figure 3.21, the LE was found as $y = 0.0006039x + 0.01246$ and the CC was 0.9966.

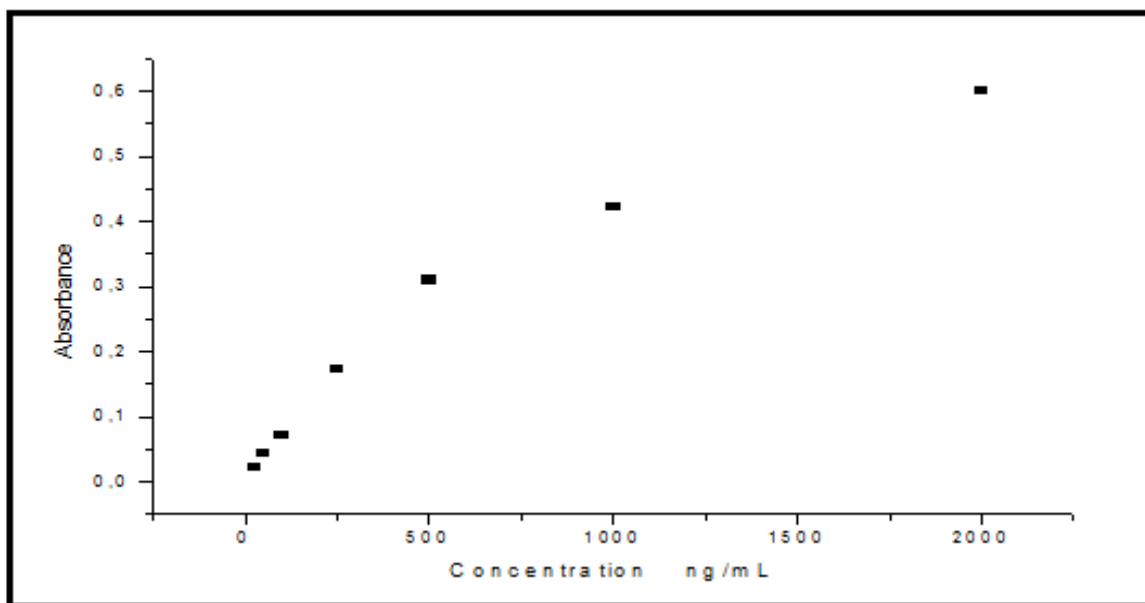

Figure 3.20 Calibration plot for Te (VI) in SQT-AT-FAAS with conditions listed in Table 3.7.

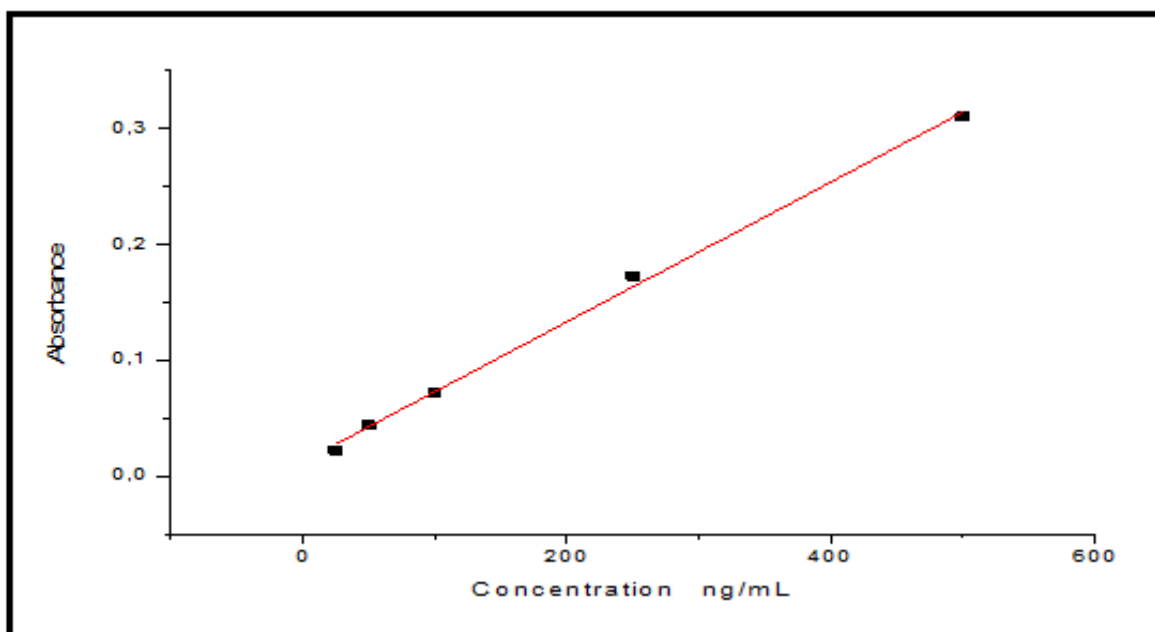

Figure 3.21 Linear calibration plot for Te (VI) in SQT-AT-FAAS with conditions listed in Table 3.7.

Limit of detection was found as 5.0 ng/mL and limit of quantification was found as 17 ng/mL. These values were rather low as compared with the previous two methods; namely SQT-FAAS and FAAS. Enhancement for sensitivity is 45 compared to SQT-FAAS and 143 compared to FAAS method.

Table 3.8 Analytical Performance of SQT-AT-FAAS for Te (VI)

Method Conditions	SQT-AT-FAAS
Linear Range, ng/mL	25.0-500.0
Limit of Detection (LOD), ng/mL	5.0
Limit of Quantification (LOQ), ng/mL	17
Characteristic Concentration (C_0), ng/mL	4.36
Characteristic mass (m_0), ng	131
Enhancement (E) (with respect to FAAS)	143
Enhancement (E) (with respect to SQT-FAAS)	45

3.3.8. Calibration Plots for Te (IV) in SQT-AT-FAAS Method

After optimizing all the parameters given in Table 3.7, a calibration plot was obtained by using a standard range of 25.0-2000.0 ng/mL Te (IV) (Figure 3.20). A linear calibration plot was obtained between the 25.0-500.0 ng/mL of Te solution. As can be seen from Figure 3.21, linear line equation was found as $y = 0.000548x + 0.0057$ and the correlation coefficient was 0.9911.

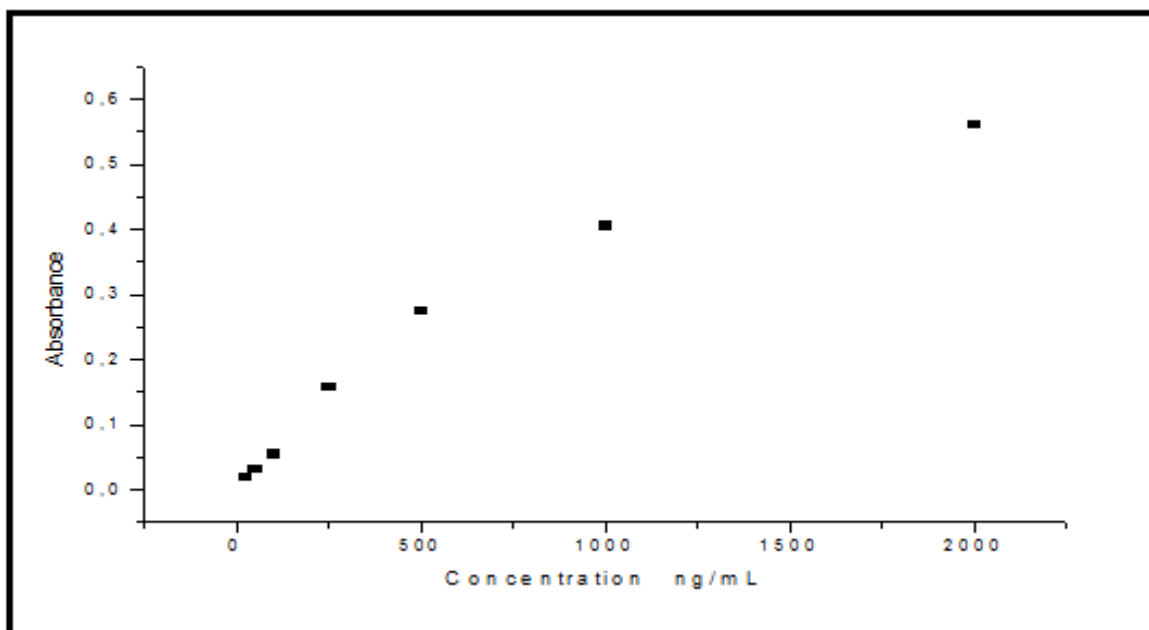

Figure 3.22 Calibration plot for Te (IV) in SQT-AT-FAAS with conditions listed in Table 3.7.

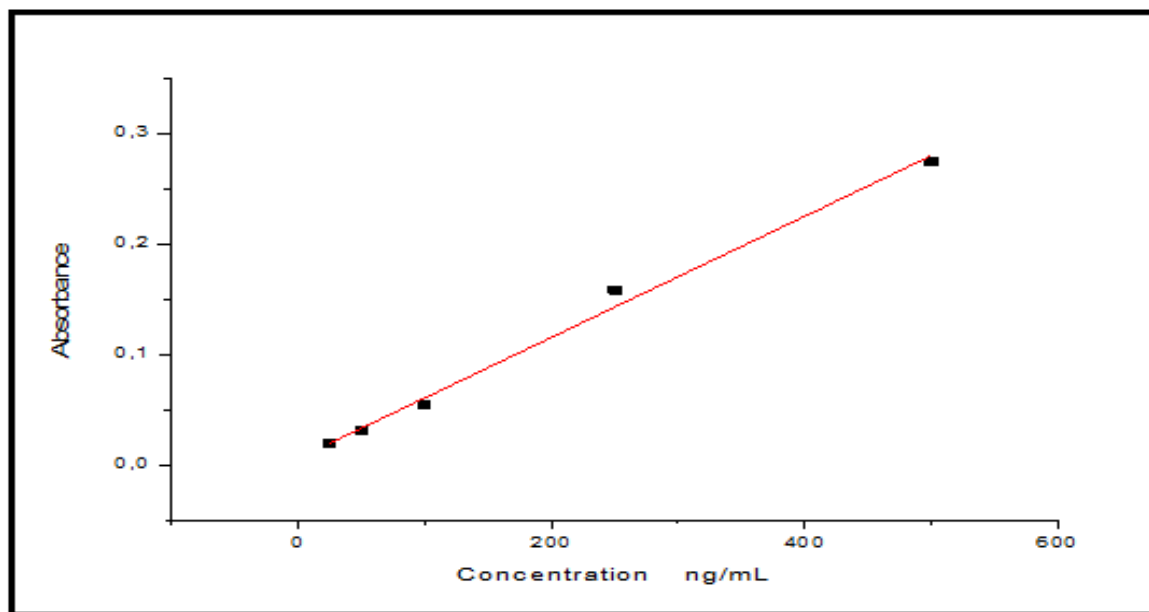

Figure 3.23 Linear calibration plot for Te (IV) in SQT-AT-FAAS with conditions listed in Table 3.7.

Limit of detection was found as 0.56 ng/mL and limit of detection was found as 1.86 ng/mL. Enhancement factor is 44 compared to SQT-FAAS method and 142 compared to conventional FAAS.

Table 3.9 Analytical Performance of SQT-AT-FAAS for Te (IV)

Method Conditions	SQT-AT-FAAS
Linear Range, ng/mL	25-500.0
Limit of Detection (LOD), ng/mL	4.6
Limit of Quantification (LOQ), ng/mL	15
Characteristic Concentration (C_0), ng/mL	4.74
Characteristic mass (m_0), ng	142
Enhancement (E) (with respect to FAAS)	142
Enhancement (E) (with respect to SQT-FAAS)	44

Table 3.10 Analytical Figures of Merit.

	Limit of Detection, LOD, 3s/m (<i>N=11</i>) ng/mL,	Limit of Quantification, LOQ, 10s/m (<i>N=11</i>) ng/mL,	Characteristic Concentration, C_0 ng/mL	Enhancement Factor*
FAAS for Te(VI)	0.55×10^3	1.85×10^3	0.623×10^3	1
FAAS for Te(IV)	0.49×10^3	1.63×10^3	0.671×10^3	1
SQT-FAAS for Te(VI)	0.20×10^3	0.67×10^3	0.194×10^3	3.2
SQT-FAAS for Te(IV)	0.18×10^3	0.60×10^3	0.208×10^3	3.2
SQT-AT-FAAS for Te(VI)	5.0	17	4.36	143
SQT-AT-FAAS for Te(IV)	4.6	15	4.74	142

* C_0 (FAAS) / C_0 (method)

3.4. Optimizations of Coated-SQT-AT-FAAS for Tellurium

The aim of this step is modification of the inner surface of the SQT to obtain a better surface than quartz in order to obtain a better detection limit. In addition, not only trap efficiency but also a successful release of the species is also important. After finding the best coating material, all parameters were optimized because of the difference behavior of surface coating element. Optimizations were done by 250.0 ng/mL Te (VI) standard solutions as indicated.

3.4.1. Examination of Coating Material on SQT-AT-FAAS Method

The melting point of the coating material should be higher than the analyte element. This is for coating material should not be significantly lost from the surface when element revolatilizes from the SQT. Effect of Ta, Zr, W, Mo, Os, Pd and Ti were investigated. Coating procedure was described in the section 2.4.

As seen in the Table 3.11, use of Pd coated and Os coated SQT devices gave the smallest signal with high RSD. Signals of Zr, W, Mo and Ta are nearly the same. The best signal was obtained using Ta among the coating elements.

Table 3.11 Coating Effect on 250.0 ng/mL Te (VI) Signal in SQT-AT-FAAS

	Absorbance	%RSD (N=3)
None	0.154	3.2
→ Ta	0.301	1.2
Zr	0.142	5.4
Mo	No signal	-
W	0.045	9.7
Os	0.205	4.4
Ti	0.132	0.5
Pd	No Signal	-

AFR: 0.8 L/min, AirFR: 3.5 L/min, Conc. of Te (VI): 250.0 ng/mL, SFR: 6.0 mL/min, DSQT: 1.0 mm, VOS: 45 µL, Type of OS: MEK, TP: 4.0 min

3.4.2. Effect of Organic Solvent

Similar to previous optimization procedure, effect of OS has been reinvestigated and MEK was selected again as the best organic solvent for complete volatilization (Table 3.12).

Table 3.12 Effect of Organic Solvents on 250.0 ng/mL Te (VI) Signal for Ta-coated-SQT-AT-FAAS Method

Type of organic solvent	Absorbance
→ MEK	0.301
MIBK	0.283
Isopropyl alcohol	No signal
N-butanol	No signal
Methanol	No signal
Ethanol	No signal
Cyclopentanol	No signal
Acetonitrile	0.085

AFR: 0.5 L/min, AirFR: 2.7 L/min, SFR: 6.0 mL/min, DSQT: 1.0 mm,

VOS: 45 μ L, TP: 4.0 min

3.4.3. Optimization of VOS

45 μ L of MEK was sufficient for the complete volatilization of the species in the tube.

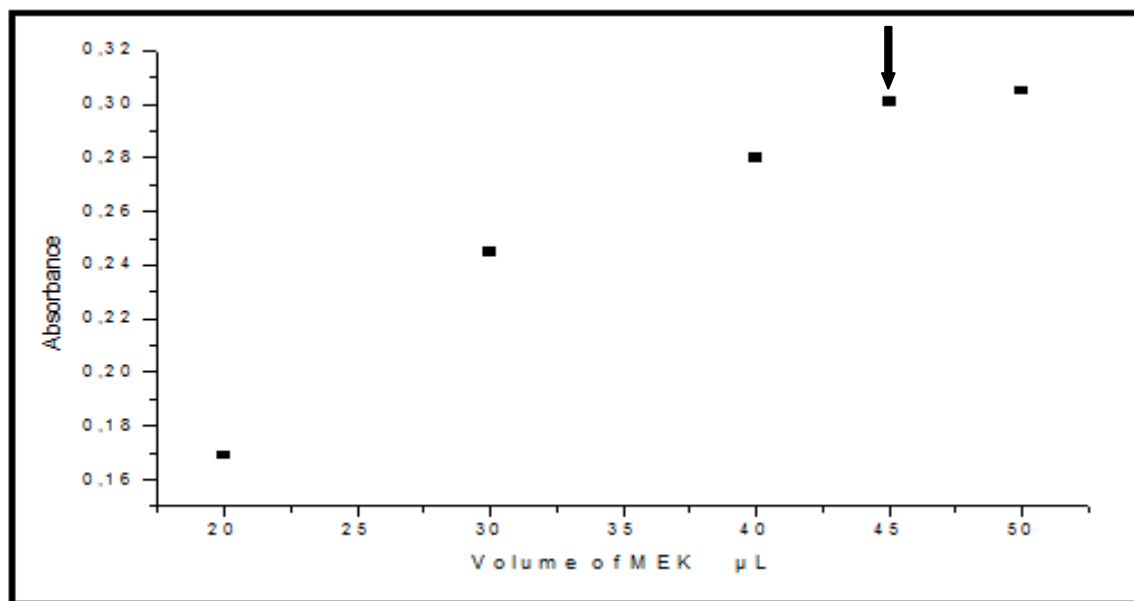

Figure 3.24 Optimization of VOS for 250.0 ng/mL Te (VI) in Ta-Coated-SQT-AT-FAAS

AFR: 0.5 L/min, AirFR: 2.7 L/min, SFR: 6.0 mL/min, DSQT: 1.0 mm, Type of OS: MEK,

TP: 4.0 min

3.4.4. Optimization of SFR

SFR was investigated between 3.0 mL/min and 7.0 mL/min (Figure 3.25). To observe the effect on Te signal, 24 mL of 250 ng/mL Te (VI) solution was used. Again at lower sample flow rates trapping efficiency is high because of increasing nebulization efficiency.

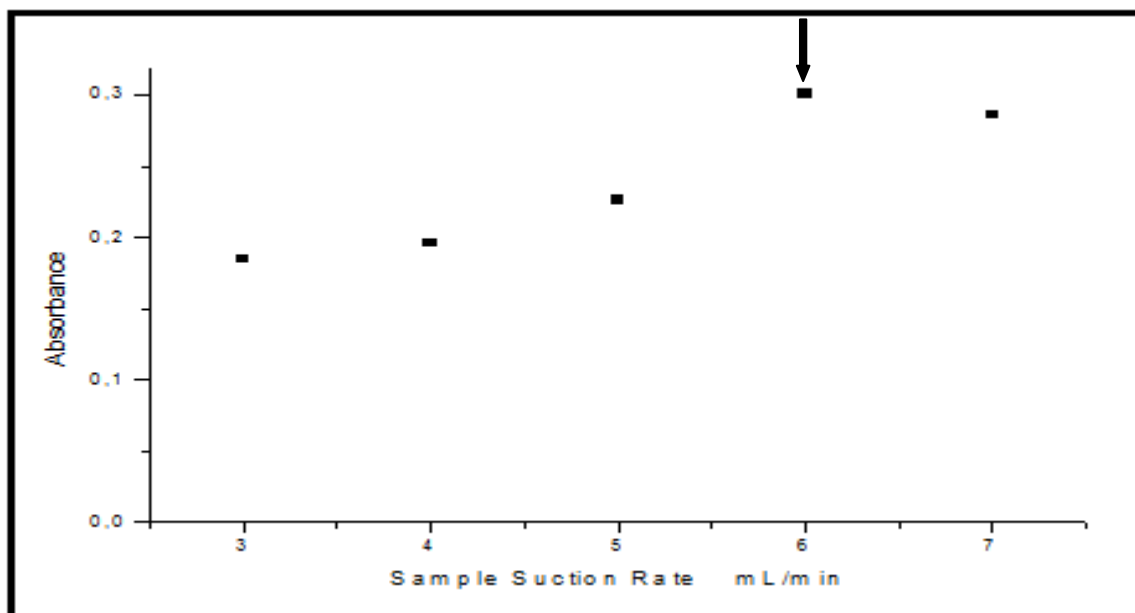

Figure 3.25 Optimization of SFR for 24 mL of 250.0 ng/mL Te (VI) in Ta Coated-SQT-AT-FAAS

AFR: 0.5 L/min, AirFR: 3.5 L/min, DSQT: 1.0 mm, Type of OS: MEK, VOS: 45 μ L

3.4.5. Optimization of AFR

As seen in the Figure 3.26, leanest possible flame gives the best result for collection step. Therefore, 0.5 L/min has been defined as the optimized AFR for the technique.

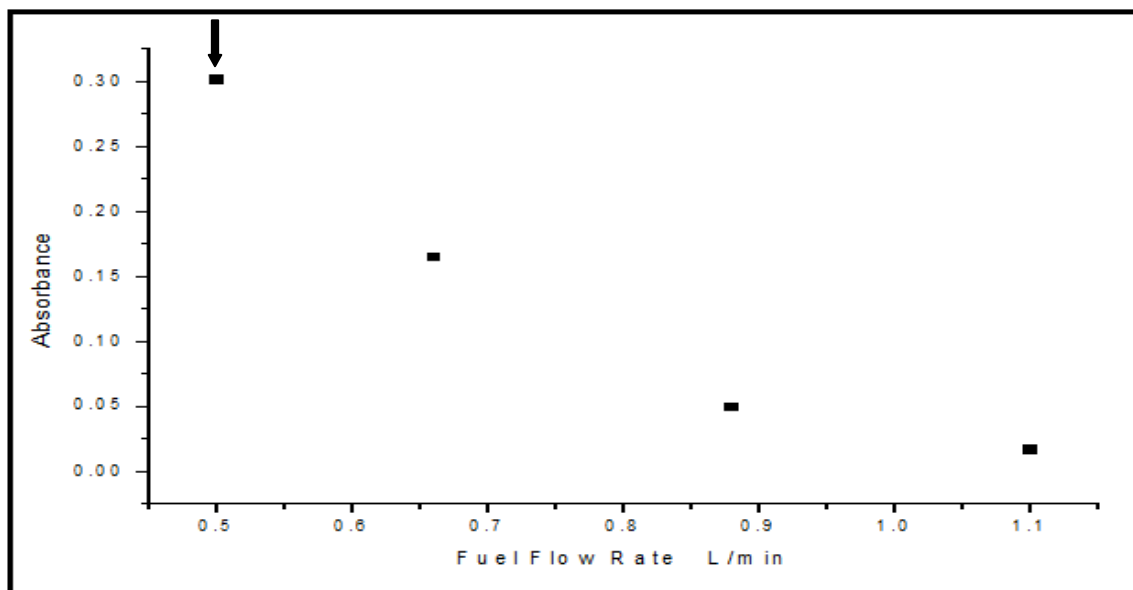

Figure 3.26 Optimization of AFR for 250 ng/mL Te (VI) in Ta-Coated-SQT-AT-FAAS
 AirFR: 2.7 L/min, SFR: 6.0 mL/min, DSQT: 1.0 mm,
 Type of OS: MEK, VOS: 45 μ L, TP: 4.0 min

3.4.6. Optimization of DSQT

Distance of the SQT to burner head of AAS was defined as 1.0 mm (Figure 3.27), it is the same reason for SQT-AT-FAAS that analyte atoms enter into the flame easily.

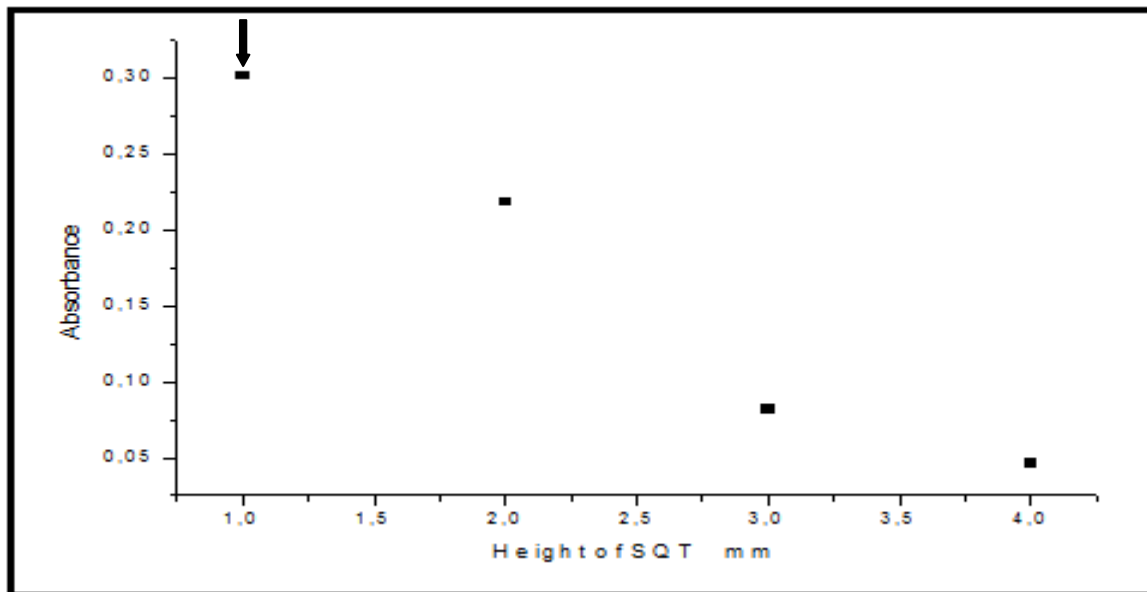

Figure 3.27 Optimization of DSQT for 250 ng/mL Te (VI) in Ta-Coated-SQT-AT-FAAS

AFR: 0.5 L/min, AirFR: 2.7 L/min, SFR: 6.0 mL/min, Type of OS: MEK, VOS: 45 μ L,
TP: 4.0 min

3.4.7. Effect of Trapping Period

As the trap time is increased, signals increased proportionally as well. However, due to the same reasons for SQT-AT-FAAS, 5 min has been designated as the optimized trapping period (Figure 3.28).

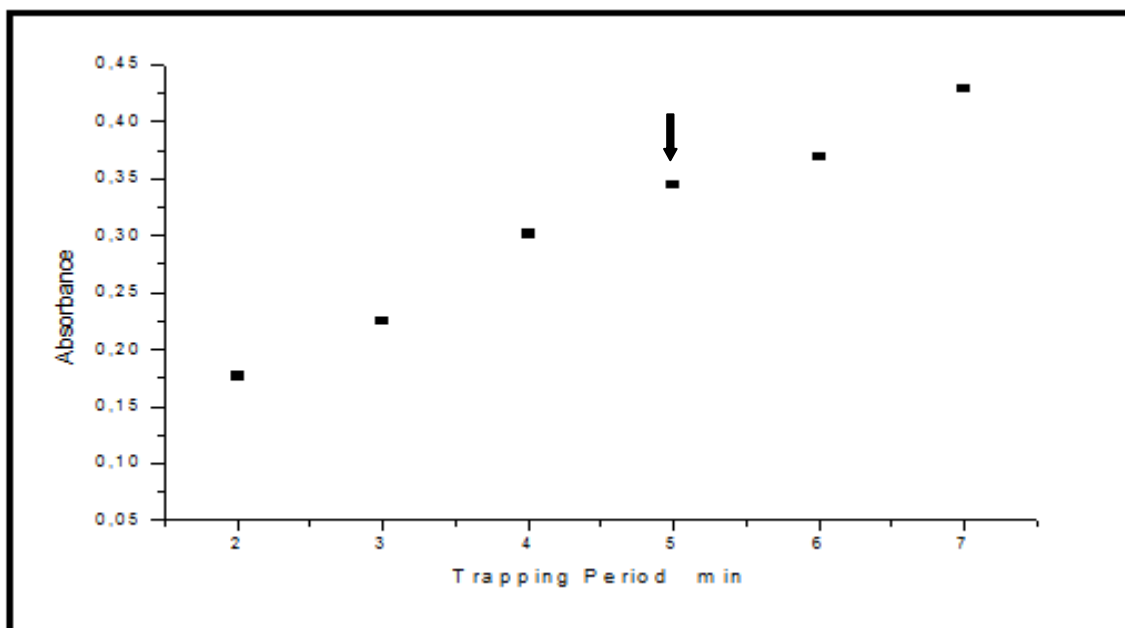

Figure 3.28 Effect of TP on 250 ng/mL Te (VI) in Ta-Coated-SQT-AT-FAAS
AFR: 0.5 L/min, AirFR: 2.7 L/min, SFR: 6.0 mL/min, DSQT: 1.0 mm, Type of OS: MEK,
VOS: 45 μ L

The signal of 250.0 ng/mL Te (VI) solution is shown in Figure 3.29; the optimum conditions in Table 3.14 were used.

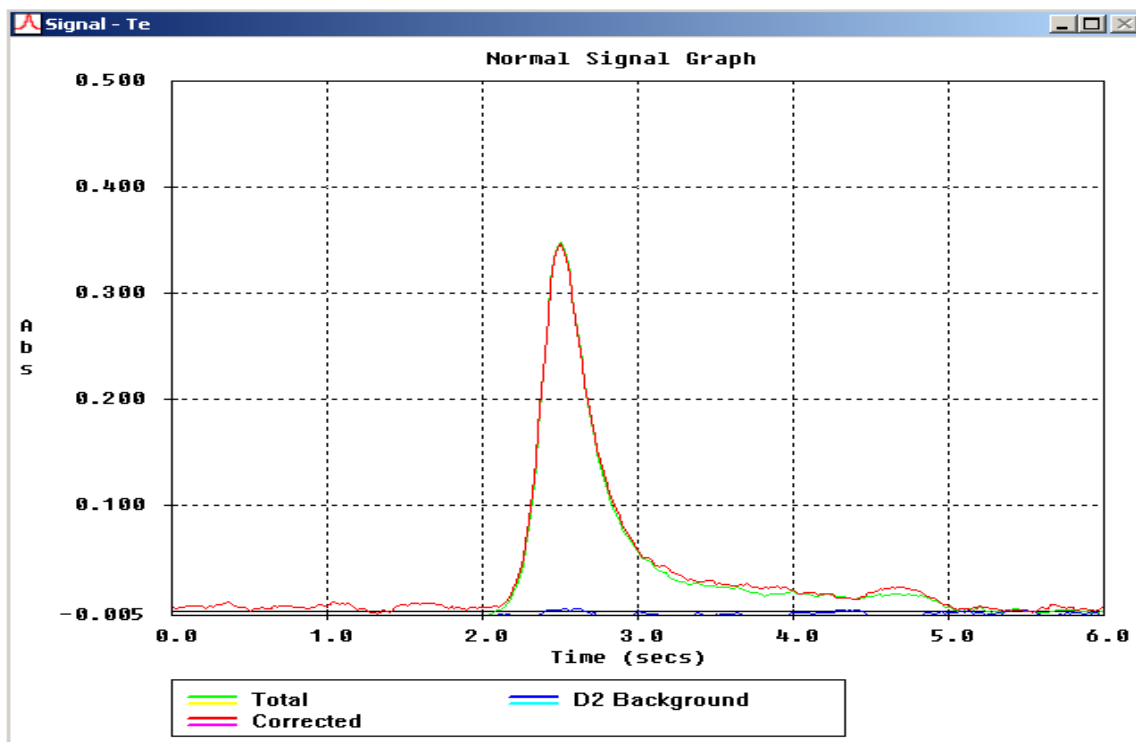

Figure 3.29 The signal of 250.0 ng/mL Te (VI) solution with the conditions listed in Table 3.13.

Table 3.13 Optimized Conditions for Ta-Coated-SQT-AT-FAAS Method

Parameters	Optimized Conditions
Coating Material	Tantalum
Type of Organic Solvent	MEK
Sample Suction Rate	6.0 mL/min
Volume of Organic Solvent	45 μ L
Trapping Period	5.0 min
Height of The SQT from the head of the burner	1.0 mm
Acetylene Flow Rate	0.5 L/min
Air Flow Rate	2.7 L/min (not optimized)

3.4.8. Calibration Plots for Te (VI) in Ta-coated-SQT-AT-FAAS

Te (VI) standards between 25-1000 ng/mL were used for calibration plot (Figure 3.30), linearity was obtained between 25-500.0 ng/mL (Figure 3.31). The LE and CC were, $y = 0.00121x + 0.01606$ and 0.9946. Conditions listed in Table 3.13 were used.

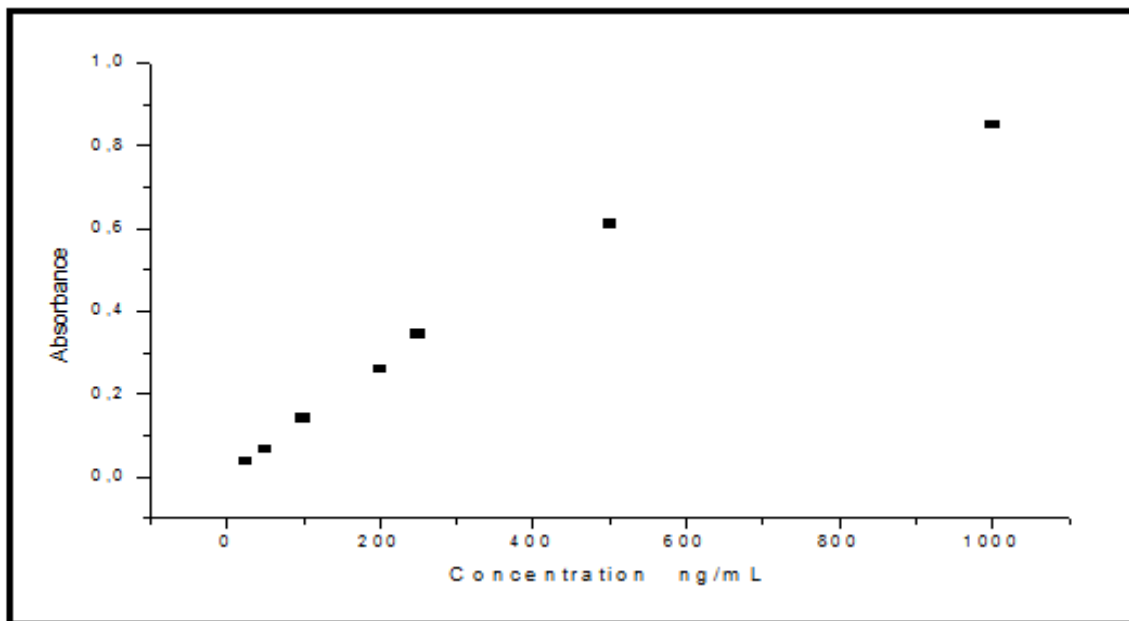

Figure 3.30 Calibration plot for Te (VI) in Ta-Coated-SQT-AT-FAAS with conditions listed in Table 3.13.

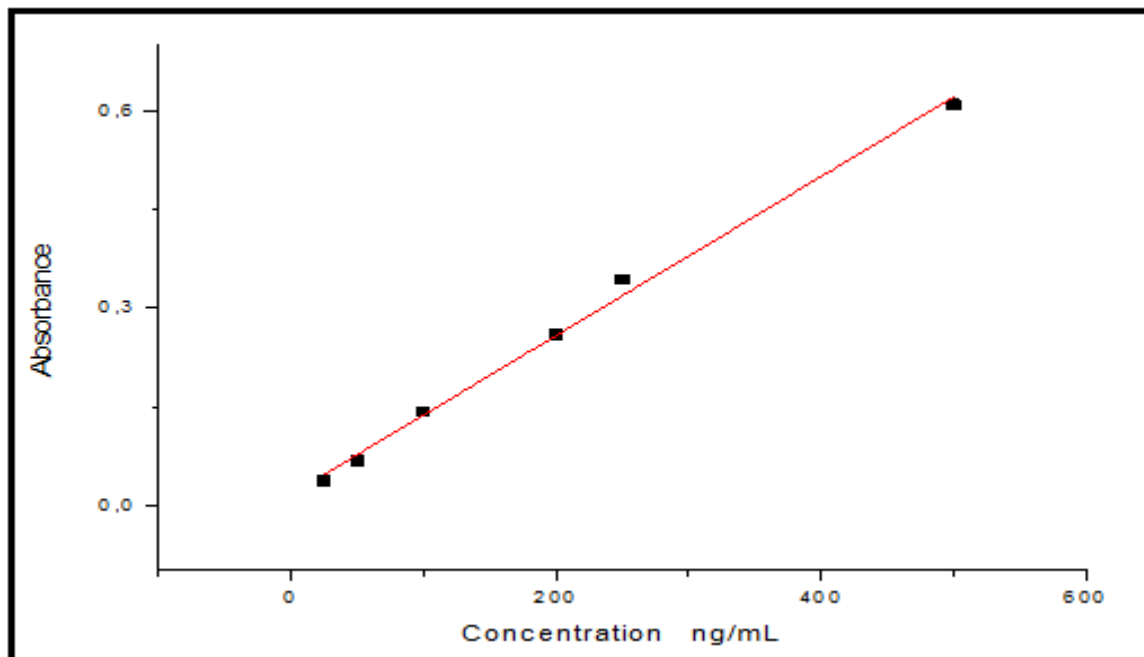

Figure 3.31 Linear calibration plot for Te (VI) in Ta-Coated-SQT-AT-FAAS with conditions listed in Table 3.13.

As demonstrated in Table 3.15, the limit of detection and limit of quantization were calculated as 3.3 ng/mL and 11 ng/mL, respectively. The characteristic concentration was estimated as 2.47 ng/mL, and the characteristic mass is 74.1 ng, resulting in a 252-fold improvement in sensitivity compared to FAAS.

Table 3.14 Analytical Performance of Te (VI) for Ta-Coated-SQT-AT-FAAS

	Ta-Coated SQT-AT-FAAS
Linear Ranges,	25-500
Limit of Detection (LOD), ng/mL	3.3
Limit of Quantitation (LOQ), ng/mL	11
Characteristic Concentration (C₀), ng/mL	2.47
Characteristic mass (m₀), ng	74.1
Enhancement (E) <i>(with respect to FAAS)</i>	252

3.4.9. Calibration Plots for Te (IV) in Ta-coated-SQT-AT-FAAS Method

Te (VI) standards between 25.0-1000.0 ng/mL has been utilized in calibration plot (Figure 3.32), linearity was obtained between 25-500.0 ng/mL (Figure 3.33). The best line equation and correlation coefficient were, $y = 0.00112x + 0.0049$ and 0.9959, respectively. Conditions given in Table 3.13 were used.

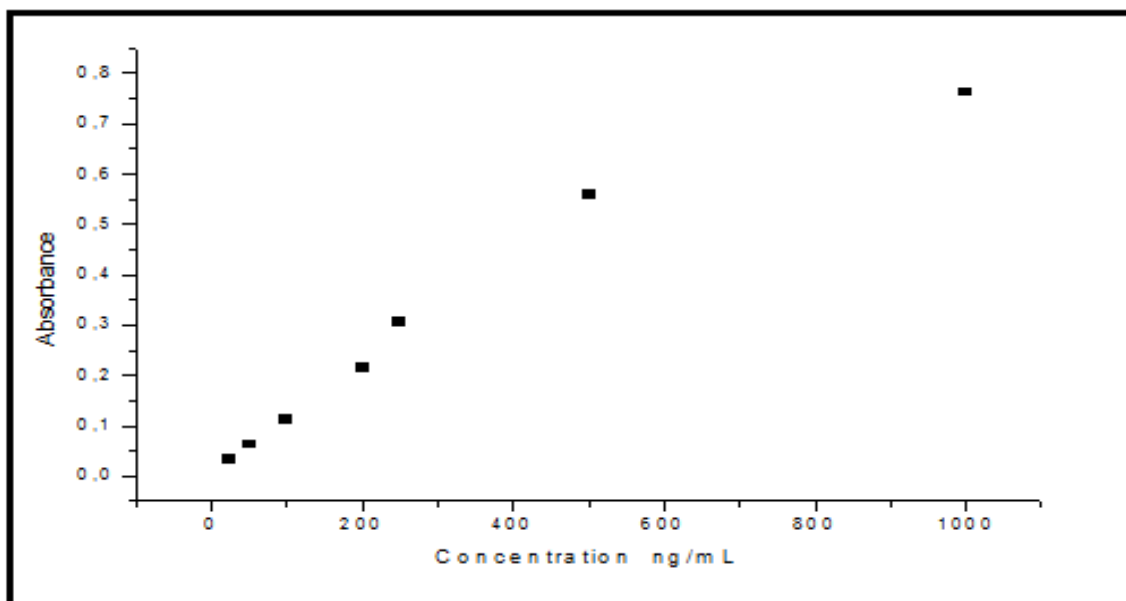

Figure 3.32 Calibration plot for Te (IV) for Ta-Coated-SQT-AT-FAAS with conditions listed in Table 3.13.

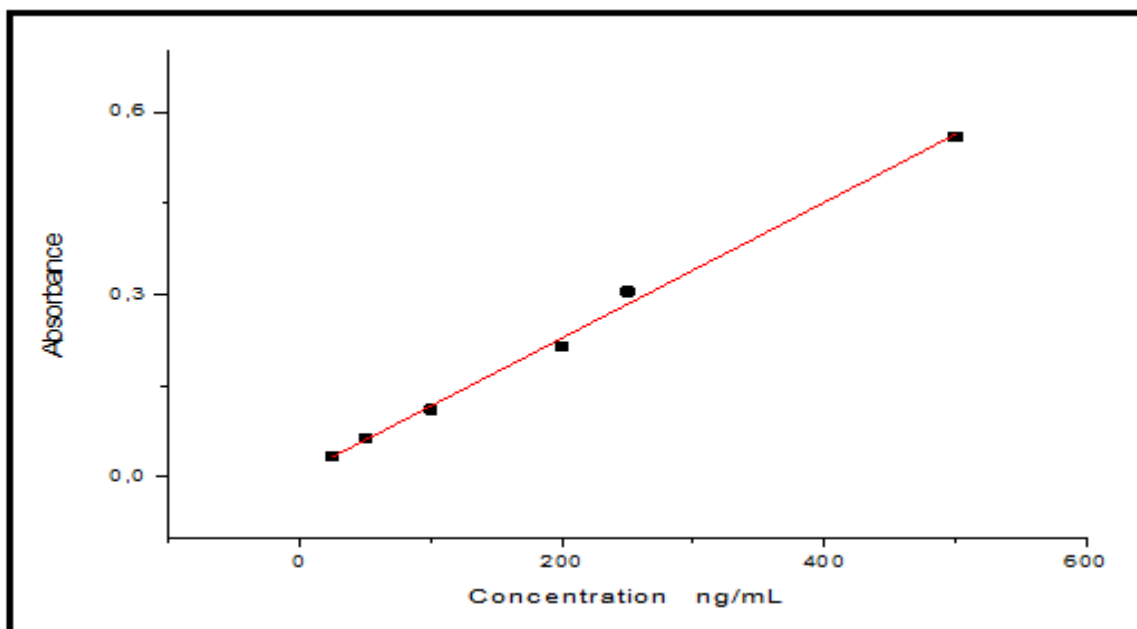

Figure 3.33 Linear calibration plot for Te (IV) in Ta-Coated-SQT-AT-FAAS with conditions listed in Table 3.13

As indicated in Table 3.15, LOD and LOQ were calculated as 3.4 ng/mL and 12 ng/mL respectively. Characteristic concentration was estimated as 2.73 ng/mL and the characteristic mass is 81.9 ng; 246 fold improvements in sensitivity has been gained compared to FAAS.

Table 3.15 Analytical Performance of Te (IV) for Ta-Coated-SQT-AT-FAAS

	Ta-Coated SQT-AT-FAAS
Linear Ranges,	25-250.0
Limit of Detection (LOD), ng/mL	3.4
Limit of Quantitation (LOQ), ng/mL	12
Characteristic Concentration (C_0), ng/mL	2.73
Characteristic mass (m_0), ng	81.9
Enhancement (E) <i>(with respect to FAAS)</i>	246

3.5. Evaluation of System Performance

The aim of the study is promoting a new method for determination of Te (VI) species at lower concentrations. The Ta-Coated-SQT-AT-FAAS has the highest sensitivity among other applied techniques. The reason for this is the higher trap efficiency of the Ta-coated system. This can be seen by checking enhancement factors between these methods. There are different “enhancement, E, factors” listed in Table 3.13. E_t and E_v values have been calculated to evaluate the methods in terms of volume and time. As it is indicated in Table 3.13, a noteworthy raise in sensitivity was observed relative to the methods of conventional FAAS and Ta Coated-SQT-AT-FAAS, which were a 252 times for Te (VI) and 246 times for Te (IV) of enhancement. The enhancement occurred

between the methods, SQT-AT-FAAS and Ta Coated-SQT-AT-FAAS can be seen in Figure 3.18.

Table 3.16 Comparison of Methods in Terms of E, E_t and E_v Values

Technique, Period, Volume	LOD, ng/mL	LOQ, ng/mL	C₀, ng/mL	m₀, ng	E (wrt FAAS)	E_t, min⁻¹	E_v, mL⁻¹
FAAS For Te (VI)	0.55 x 10 ²	1.85 x 10 ³	0.623 x 10 ³	-	1	-	-
FAAS For Te (IV)	0.49 x 10 ³	1.63 x 10 ³	0.671 x 10 ³	-	1	-	-
SQT-FAAS For Te (VI)	0.20 x 10 ³	0.67 x 10 ³	0.194 x 10 ³	-	3.2	-	-
SQT-FAAS For Te (IV)	0.18 x 10 ³	0.60 x 10 ³	0.208 x 10 ³	-	3.2	-	-
SQT-AT-FAAS For Te (VI) <i>5.0 min, 30.0 mL</i>	5.0	17	4.36	131	143	28.6	4.8
SQT-AT-FAAS For Te (IV) <i>5.0 min, 30.0 mL</i>	4.6	15	4.74	142	142	28.3	4.7
Ta-Coated-SQT-AT- FAAS For Te (VI) <i>5.0 min, 30.0 mL</i>	3.3	11	2.47	74.1	252	50.4	8.4
Ta-Coated-SQT-AT- FAAS For Te (IV) <i>5.0 min, 30.0 mL</i>	3.5	12	2.73	81.9	246	49.1	8.2

$$E = C_{0 \text{ (FAAS)}}/C_{0 \text{ (Selected Method)}}, E_t = E/t_{\text{total}}, E_v = E/v_{\text{total}}$$

Table 3.17 Comparison of Developed Methods with Other Techniques

	LOD Values (ng/mL)	Reference
GFAAS	2.6	[33]
HGAAS	2.2	[34]
ICP-MS	0.027	[35]
ICP-OES	1.32	[36]
FAAS For Te (VI)	550	This study
FAAS For Te (IV)	490	This study
SQT-FAAS For Te (VI)	200	This study
SQT-FAAS For Te (IV)	180	This study
SQT-AT-FAAS For Te (VI) <i>5.0 min, 30 mL</i>	5.0	This study
SQT-AT-FAAS For Te (IV) <i>5.0 min, 30 mL</i>	4.6	This study
Ta-coated-SQT-AT-FAAS For Te (VI) <i>5.0 min, 30 mL</i>	3.3	This study
Ta-coated-SQT-AT-FAAS For Te (IV) <i>5.0 min, 30 mL</i>	3.5	This study

3.6. Interference Effects of Various Elements in Ta-Coated SQT-AT-FAAS

Interferences are divided into spectral and non-spectral ones that are an important step for evaluation of the method. Other species than those of free tellurium atoms can take in radiation and cause spectral interferences. The most preferred interferences were the ones owing to the matrix of the solution.

For this purpose, 3 different samples have been arranged with concentrations of Te (IV) and Te (VI) has been constant as 100.0 ng/mL. Interference amounts have been 1.0, 10, and 100 folds of the analyte amounts using the mass ratios.

In order for observing the effect of various transition metals, a set of solutions containing Te (VI) and Te (IV) separately and interfering element in 1, 10, and 100 folds excess were prepared. Fe, Cu and Al ions were used as the possible interferants in transition elements. No significant interference was observed for Fe at any ratio. However, there are interferences in case of Cu and Al shown in Figure 3.34 and Figure 3.35; interference of Al is higher as compared to Fe and Cu.

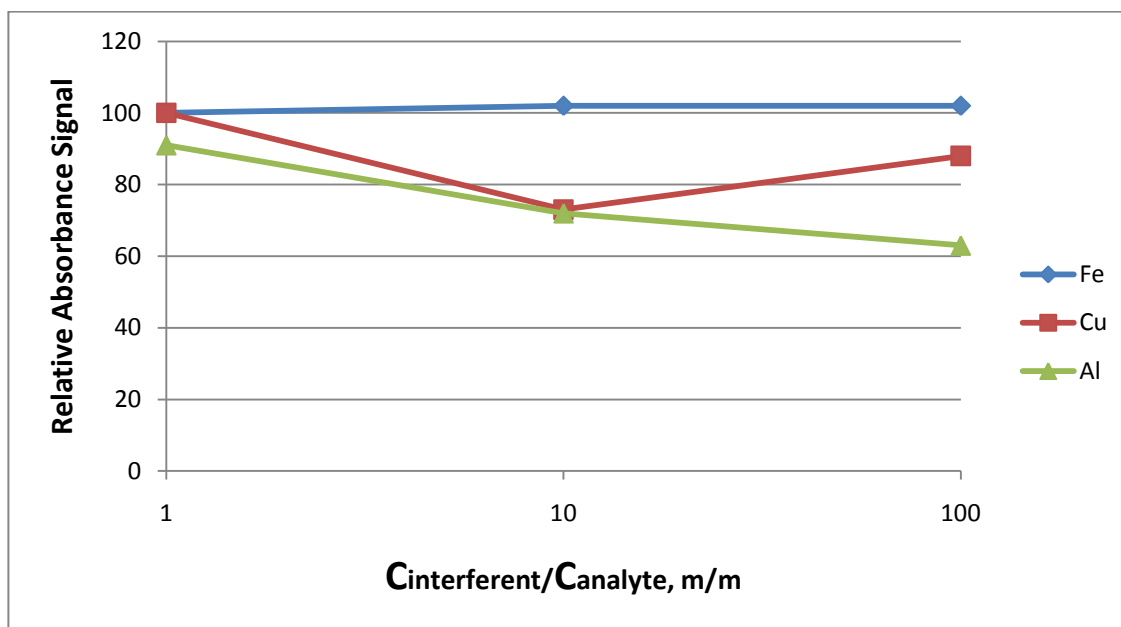

Figure 3.34 Interferant effects of Fe, Cu and Al for 100.0 ng/mL Te (VI) in Ta-Coated-SQT-AT-FAAS

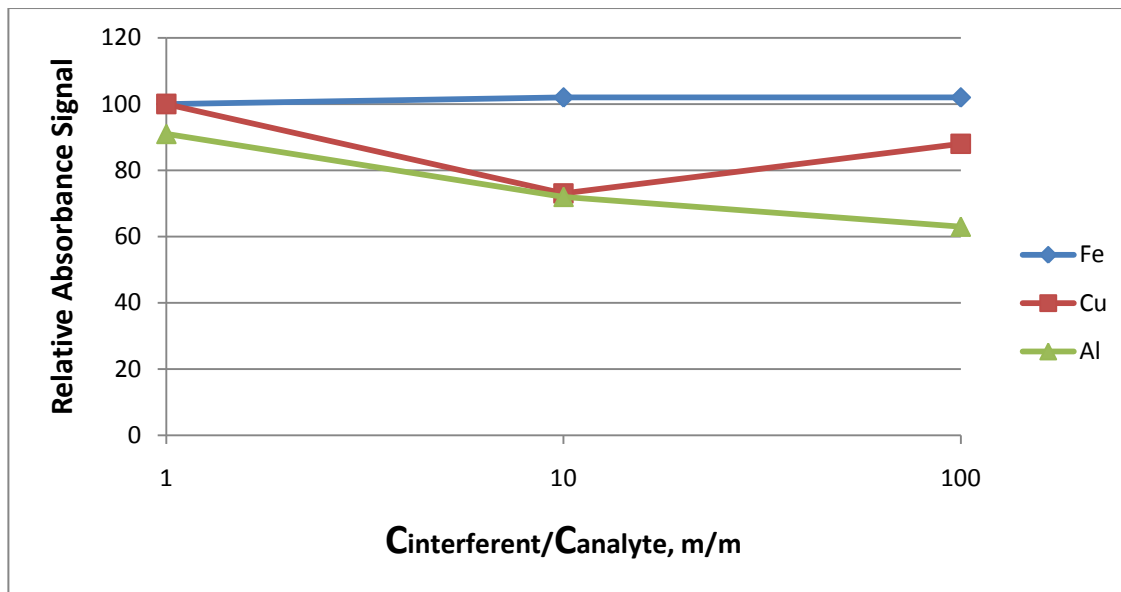

Figure 3.35 Interferant effects of Fe, Cu and Al of 100.0 ng/mL Te (IV) in Ta-Coated-SQT-AT-FAAS

To see the effect of hydride forming elements Te (VI) and Te (IV) solutions were prepared in 1, 10, and 100 fold mass ratios of analyte/interferent for As(III), Sb(III), and Se (IV) species; AsO_4^{3-} , SbO_4^{3-} , AsO_3^{2-} , respectively. It was observed that Se decreased both Te (VI) and Te (IV) signals by around 10% at 10 fold excess and 20% at 100 fold excess. But As only decreased the signal for 100 fold excess. The most significant interference for hydride forming elements was observed for Sb. There was 55 % decrease in 10 fold excess and more than 80 % decrease in 100 fold excess of Sb. The reason for this sharp decrease could be due to usage of antimony tartarate. It was observed that the suppressive interference of Sb is partially due to tartrate ion present in the standard used, potassium antimony tartarate, $\text{C}_4\text{H}_4\text{O}_7\text{SbK}$.

Solutions containing the same molarity of tartaric acid equivalent to that in $C_4H_4O_7SbK$ were prepared and treated as the interfering agent. While the 10 fold Sb decreased the signal of Te from 100 to 47, the tartaric acid caused a reduction from 100 to 66. In the case of 100 fold Sb, Sb solution caused a reduction from 100 to 12, while the tartarate alone caused a reduction from 100 to 48. Organic nature of Sb standard solution may be causing a change in the nature of air-acetylene flame.

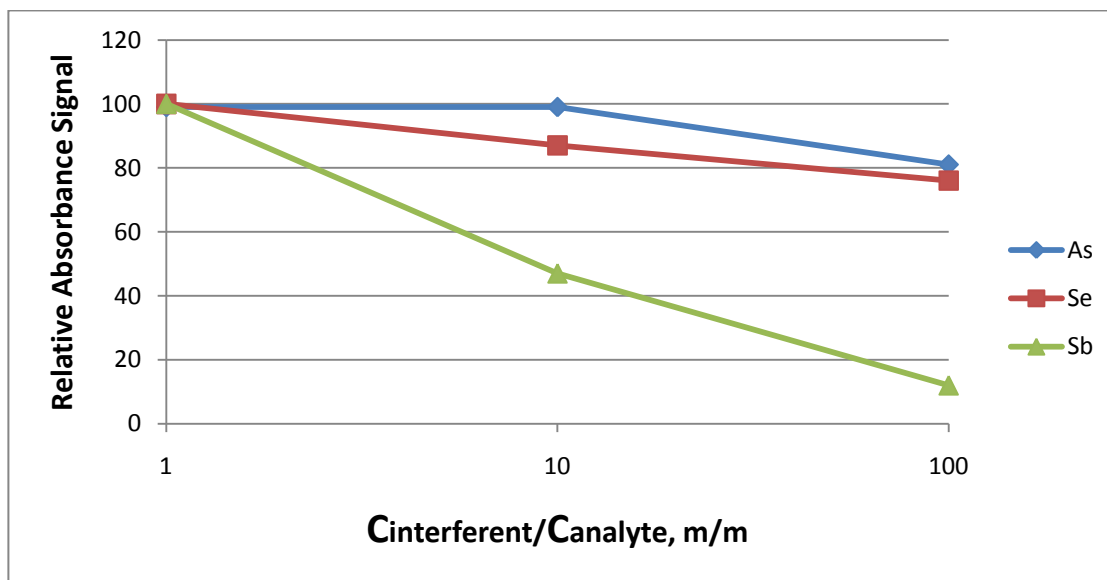

Figure 3.36 Interferants of As, Sb, and Se for 100.0 ng/mL Te (VI) in Ta-Coated-SQT-AT-FAAS

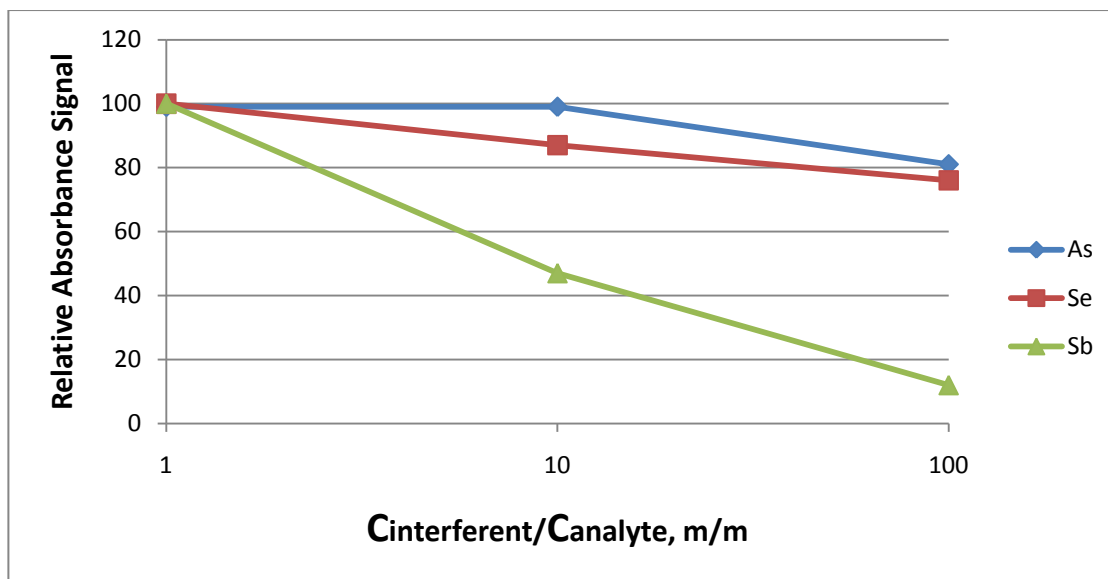

Figure 3.37 Interferants of As, Sb, and Se for 100.0 ng/mL Te (IV) in Ta-Coated-SQT-AT-FAAS

Effects on earth metals was studied with Na^+ , Ca^{2+} and Mg^{2+} that were selected as the representative elements for the study. There was 10 % increase in Te signals for 10 fold excess of Na and about 25 % increase in 100 fold excess of Na. However, for Ca and Mg we observed about 15 % decrease in 10 fold excess and more decrease in 100 fold excess of these two elements. (Figure 3.38).

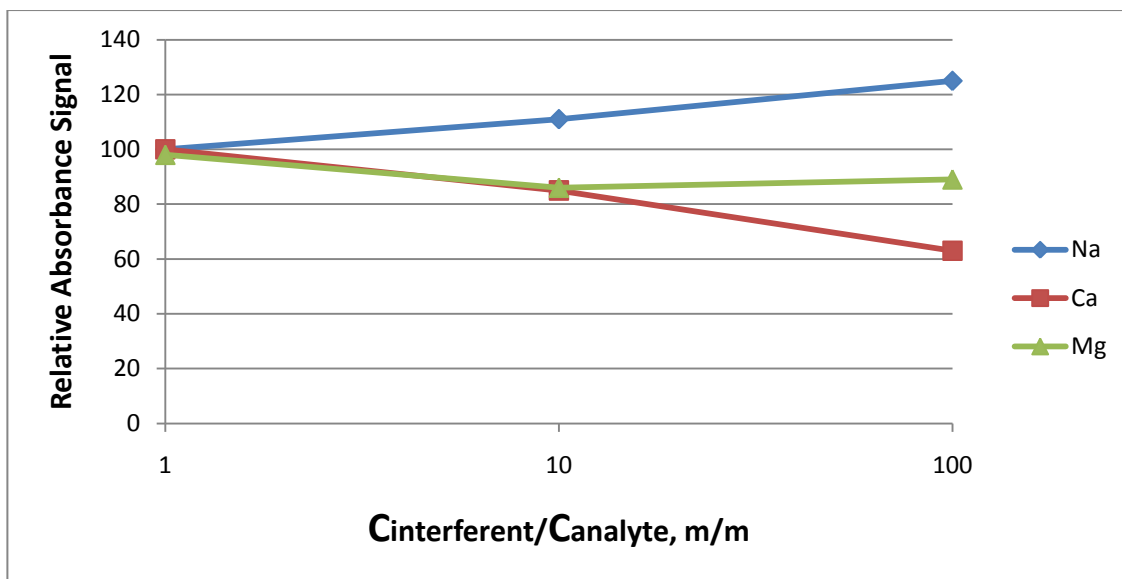

Figure 3.38 Interferant of Ca, Na and Mg for 100.0 ng/mL Te (VI) in Ta-Coated-SQT-AT-FAAS

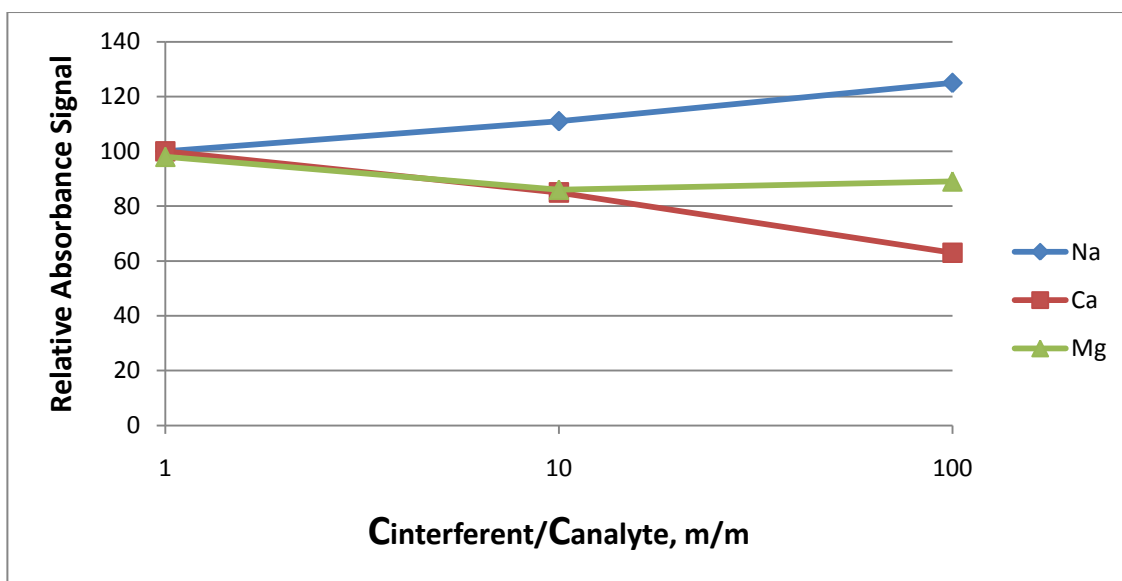

Figure 3.39 Interferants of Ca, Na and Mg for 100.0 ng/mL Te (IV) in Ta-Coated-SQT-AT-FAAS

Table 3.18. Summary for Interference Studies of Te (VI) and Te (IV) for Ta-Coated-SQT-AT-FAAS

Elements	Folds of Interferent	Ta-Coated-SQT-AT-FAAS Te (VI)	Ta-Coated-SQT-AT-FAAS Te (IV)
		Signal Relative to 100	Signal Relative to 100
Na	1	100	100
	10	111	110
	100	125	124
Ca	1	100	100
	10	85	85
	100	63	65
Mg	1	98	97
	10	86	86
	100	89	88
Fe	1	100	100
	10	102	99
	100	102	101
Cu	1	100	100
	10	73	74
	100	88	89
Al	1	91	94
	10	72	73
	100	63	63
As	1	99	99
	10	99	99
	100	81	82
Se	1	100	98

	10	87	86
	100	76	76
Sb	1	100	100
	10	47	49
	100	12	15

CHAPTER 4

CONCLUSIONS

A sensitive analytical method in order to determine tellurium was aimed in this study and using various methods in FAAS, especially the use of Ta coating with atom trapping SQT has produced useful results regarding this target.

The study focused on the usage of SQT in FAAS in two different sorts. First, in SQT-FAAS, it has been applied for increasing the resident of tellurium species in the light route as well as for obtaining steady environment to achieve a rise in sensitivity. The LOD and C_0 have been calculated as 0.55×10^3 and 0.623×10^3 for Te (VI) and 0.49×10^3 and 0.671×10^3 ng/mL for Te (IV), respectively and this was 3.2 times enhancement both for Te (VI) and Te (IV) compared to FAAS. Second, for enhancing the sensitivity, SQT has been utilized as trapping equipment. In this trapping process, other improving methods like trap in optimum collection period and organic solvent aspiration. Various coatings have been investigated on the inside wall of the quartz; Tantalum has found as the most suitable coating that gives the highest absorbance values. After optimizing all necessary parameters, Ta-coated SQT has significant results, and LOD and C_0 were found 3.3 ng/mL and 2.5 ng/mL for Te (VI) and 3.5 ng/mL and 2.7 ng/mL for Te (IV). In addition, there is a sensitivity improving of 252 times for Te (VI) and 246 times for Te (IV) compared to FAAS.

Interference effects of some alkali, transition and hydride forming elements were investigated for Ta-coated SQT-AT-FAAS. It has been observed the interference effects of transition elements are rather low; on the other hand the effect of hydride forming elements are comparatively higher, especially in the case of interferent that is 100 fold or more of Te.

When compared to many other preconcentration techniques employed, the advantages of *in-situ* trapping as used in this study are, smaller sample volume requirement, shorter analysis period, less steps and lower sources of error.

In conclusion, in determination of Te (VI) and Te (IV), atom trapping techniques have the main advantage of high sensitivity at the levels of ng/mL. On the other hand, the technique requires only a simple flame AA spectrometer; low cost and simple analyses are possible.

Unfortunately, no suitable SRM or CRM is available for Te in the concentration range used in this study. Therefore accuracy checks could not be completed.

REFERENCES

- [1] Andreae, M. O. (1984). "Determination of inorganic tellurium species in natural waters", *Anal. Chem.*, 56, 2064-2066.
- [2] Chizikov D.M., Shchastlivyi V.P., Tellurium and Tellurides, Collets Ltd. London and Wellingborough, 1970.
- [3] Tellurium: geological information. (2009). Retrieved 06 2009, from WebElements: <http://www.webelements.com/tellurium/geology.html>
- [4] Taylor A., "Biochemistry of tellurium", *Biol. Trace Elem. Res.*, 1996, p. 231-239.
- [5] D. A. Skoog, F. J. Holler, T. A. Nieman, "Principles of Instrumental Analysis" Thomson Learning Inc, USA, 4th edition, 1998.
- [6] Xu, P; Sun, Y.L., "Determination of Ga, Ge, As, Se, Cd, Sn, Sb, Te, Hg, Pb and Bi in environmental samples by Inductively Coupled Plasma Mass Spectrometry Combined with Carius Tube Digestion, *Chinese J. Anal. Chem.* 38 (2010) 581-584.
- [7] Xiong, CM; Hu, B., "Headspace trapping of the hydrides on a Pd(II)-coated graphite adsorptive bar as a microextraction method for ETV-ICP-MS determination of Se, Te and Bi in seawater and human hair samples." *Talanta*, 81 (1-2) 578-585.
- [8] B. Welz, M. Sperling, "Atomic Absorption Spectrometry", Wiley-VCH, Germany, 1999.
- [9] O. Y. Ataman, "Vapor generation and atom traps: atomic and absorption spectrometry at the ng/L level", *Spectrochim. Acta Part B* 63 (2008) 825-834.
- [10] Ghasemi, E; Najafi, NM; Raofie, F; et al. "Simultaneous speciation and preconcentration of ultra traces of inorganic tellurium and selenium in environmental samples by hollow fiber liquid phase microextraction prior to electrothermal atomic absorption spectroscopy determination" *J. Hazard. Mater.* 181 (1-3) (2010) 491-496.
- [11] Najafi, NM; Tavakoli, H; Alizadeh, R; et al. "Speciation and determination of ultra trace amounts of inorganic tellurium in environmental water samples by dispersive

liquid-liquid microextraction and electrothermal atomic absorption spectrometry.“ *Anal. Chim. Acta*, 670 (1-2): 18-23, 2010.

[12] V.I. Slaveykova et al. “Permanent iridium modifier deposited on tungsten and zirconium-treated platforms in electrothermal atomic absorption spectrometry: vaporization of bismuth, silver and tellurium” *Spectrochimica Acta Part B: Atom. Spectrosc.* 54 (1999) 455-467, 1998.

[13] Zhang, N; Fu, N; Fang, ZT; et al. “Simultaneous multi-channel hydride generation atomic fluorescence spectrometry determination of arsenic, bismuth, tellurium and selenium in tea leaves” *Food Chem.*, 124 (3): 1185-1188, 2011.

[14] J. R. Dean, “Atomic Absorption and Plasma Spectroscopy”, John Wiley&Sons, England, 1997.

[15] H. Matusiewicz, “Atom trapping in situ preconcentration techniques for flame atomic absorption spectrometry”, *Spectrochim. Acta Part B* 52 (1997) 1711-1736.

[16] H. T. Delves, “A micro-sampling method for the rapid determination of arsenic in blood by atomic –absorption spectrophotometry”, *Analyst* 95 (1970) 431-438.

[17] Holak, W. “Gas-sampling technique for arsenic determination by atomic absorption spectrophotometry”, *Anal. Chem.* 41 (1969) 1712-1713.

[18] H. Matusiewicz, R. E. Sturgeon, “Atomic spectrometric detection of hydride forming elements following *in situ* trapping within a graphite furnace”, *Spectrochim. Acta Part B* 51 (1996) 377-397.

[19] N. Ertaş, Z. Arslan, J. F. Tyson, “Determination of lead by hydride generation atom trapping flame atomic absorption spectrometry”, *J. Anal. At. Spectrom.* 23 (2008) 223-228.

[20] X. Yan, Z. Ni, “Determination of arsenic by hydride generation atomic absorption spectrometry with *in situ* concentration in a zirconium coated graphite tube”, *J. Anal. At. Spectrom.* 6 (1991) 483-486.

[21] D. K. Korkmaz, N. Ertaş, O. Y. Ataman, “A novel silica trap for lead determination by hydride generation atomic absorption spectrometry”, *Spectrochim. Acta Part B* 57 (2002) 571-580.

- [22] M. Xi, R. Liu, P. Wu, K. Xu, X. Hou, Y. Lv, "Atomic absorption spectrometric determination of trace tellurium after hydride trapping on platinum-coated tungsten coil", *Microchem. J.* 95 (2010) 320–325.
- [23] O. Cankur, N. Ertaş, O. Y. Ataman, "Determination of bismuth using on-line preconcentration by trapping on resistively heated W coil and hydride generation atomic absorption spectrometry", *J. Anal. At. Spectrom.* 17 (2002) 603-609.
- [24] F. Barbosa Jr., S. S. de Souza, F. J. Krug, "in situ trapping of selenium hydride in rhodium-coated tungsten coil electrothermal atomic absorption spectrometry" *J. Anal. At. Spectrom.* 17 (2002) 382–388.
- [25] S. Titretir, E. Kendüzler, Y. Arslan, İ. Kula, S. Bakırdere, O. Y. Ataman, "Determination of antimony by using tungsten trap atomic absorption spectrometry" *Spectrochim. Acta Part B* 63 (2008) 875-879.
- [26] Y. V. Zeljukova, N.S. Poluektov, "Atomic absorption analysis by means of exhaust gases of the flame", *Zh. Anal. Khim.* 18 (1963) 435-439.
- [27] H Matusiewicz, M. Kopras, "Methods for improving the sensitivity in atom trapping flame atomic absorption spectrometry: analytical scheme for the direct determination of trace elements in beer" *J. Anal. At. Spectrom.* 12 (1997) 1287-1291.
- [28] N. Ertaş, D. K. Korkmaz, S. Kumser, O. Y. Ataman, "Novel traps and atomization techniques for flame AAS", *J. Anal. At. Spectrom.* 17 (2002) 1415-1420.
- [29] H Matusiewicz, M. Kopras, "Methods for improving the sensitivity in atom trapping flame atomic absorption spectrometry: analytical scheme for the direct determination of trace elements in beer" *J. Anal. At. Spectrom.* 12 (1997) 1287-1291.
- [30] A.D. Turner, D.J. Roberts, "Metal determinations with a novel slotted-tube water cooled atom trap", *J. Anal. At. Spectrom.* 11 (1996) 231–234.
- [31] R. J. Watling, D. J. De Villers, " A slotted quartz tube for increasing sensitivity in flame atomic absorption analysis", Special Report, FIS 108, Division of Applied Spectroscopy, National Physical Research Laboratory, Council for Scientific and Industrial Research, Pretoria, South Africa, 1977.

- [32] O. Y. Ataman, "Economical alternatives for high sensitivity in atomic spectrometry laboratory", *Pak. J. Anal. Chem.* 8 (2007) 64-68.
- [33] A. A. Brown, B. Milner, A. Taylor, "Use of a slotted quartz tube to enhance the sensitivity of conventional flame atomic absorption spectrometry", *Analyst* **110** (1985) 501-505.
- [34] S. Kumser, "Atom trapping atomic absorption spectrometry using organic solvent atomization", M.S. thesis, Middle East Technical University, Ankara, Turkey, 1995.
- [35] B. Arı, "Development of Sensitive Analytical Methods for Thallium Determination by Atomic Absorption Spectrometry", M.S. thesis, Middle East Technical University, Ankara, Turkey, 2009.
- [36] İ. Demirtaş, "Lead Determination by Flame Atomic Absorption Spectrometry Using a Slotted Quartz Atom Trap and Metal Coatings", M.S. thesis, Middle East Technical University, Ankara, Turkey, 2009.
- [37] P. Özcan Gurbetoğlu, "Determination of Cadmium Using Slotted Quartz Tube Atom Trap Atomic Absorption Spectrometry and Metal Coatings", M.S. thesis, Middle East Technical University, Ankara, Turkey, 2010.
- [38] Willis, J.B., Sturmman, B.T., Observations on the effect of oxidation state on the sensitivity of flame AAS determinations of tellurium, *J. Anal. At. Spectrom.* 14 (1999) 895-896.
- [39] Hüseyin Bekir Yıldız, "Oxidation State Related Evaluation of Tellurium Determination by Flame AAS and Use of Slotted Silica Trap", M.S. thesis, Middle East Technical University, Ankara, June 2002.