

**ANAEROBIC TREATABILITY AND BIOGAS PRODUCTION POTENTIAL
OF PISTACHIO PROCESSING WASTEWATER WITH UPFLOW
ANAEROBIC SLUDGE BLANKET (UASB) REACTOR**

A THESIS SUBMITTED TO
THE GRADUATE SCHOOL OF NATURAL AND APPLIED SCIENCES
OF
MIDDLE EAST TECHNICAL UNIVERSITY

BY

ERAY GÜR

IN PARTIAL FULFILLMENT OF THE REQUIREMENTS
FOR
THE DEGREE OF MASTER OF SCIENCE
IN
ENVIRONMENTAL ENGINEERING

AUGUST 2016

Approval of the thesis:

**ANAEROBIC TREATABILITY AND BIOGAS PRODUCTION POTENTIAL
OF PISTACHIO PROCESSING WASTEWATER WITH UPFLOW
ANAEROBIC SLUDGE BLANKET (UASB) REACTOR**

Submitted by **ERAY GÜR** in partial fulfillment of the requirements for the degree of
**Master of Science in Environmental Engineering Department, Middle East
Technical University** by,

Prof. Dr. Gülbin Dural Ünver
Dean, Graduate School of **Natural and Applied Sciences** _____

Prof. Dr. Kahraman Ünlü
Head of Department, **Environmental Engineering** _____

Prof. Dr. Göksel N. Demirer
Supervisor, **Environmental Engineering Dept., METU** _____

Examining Committee Members:

Prof. Dr. Faika Dilek Sanin
Environmental Engineering Dept., METU _____

Prof. Dr. Göksel N. Demirer
Environmental Engineering Dept., METU _____

Assist. Prof. Dr. Evren Doruk Engin
Basic Biotechnology, Dept., Ankara University _____

Assoc. Prof. Dr. Tuba Hande Ergüder
Environmental Engineering Dept., METU _____

Assoc. Prof. Dr. Emre Alp
Environmental Engineering Dept., METU _____

Date: August 08, 2016

I hereby declare that all information in this document has been obtained and presented in accordance with academic rules and ethical conduct. I also declare that, as required by these rules and conduct, I have fully cited and referenced all materials and results that are not original to this work.

Name, Last Name: Eray Gür
Signature:

ABSTRACT

ANAEROBIC TREATABILITY AND BIOGAS PRODUCTION POTENTIAL OF PISTACHIO PROCESSING WASTEWATER WITH UPFLOW ANAEROBIC SLUDGE BLANKET (UASB) REACTOR

Gür, Eray
M.Sc., Environmental Engineering Department
Supervisor: Prof. Dr. Göksel N. Demirer

August 2016, 93 pages

Agro-industrial wastes cannot be treated in conventional wastewater treatment plants due to high organic contents. However, they have a high potential as renewable energy resources, and can be converted into valuable end products via application of appropriate treatment technologies. Anaerobic digestion (AD) is a process which converts organic materials into methane and carbon dioxide in the absence of oxygen. Therefore, well-established anaerobic biotechnologies, such as up-flow anaerobic sludge blanket (UASB) reactors, have been widely adopted worldwide as a tool for not only treatment but also valorization of agro-industrial wastes.

In Turkey, 130000 tons of pistachio and 520000 tons of pistachio processing wastewater are produced annually. However, academic studies on anaerobic treatability of pistachio are limited.

The aim of this thesis is determination of the efficiency of AD process for the treatment of pistachio processing wastewaters, a local agro-industrial waste, and production of biogas as surplus renewable energy source during the treatment process. To this purpose: (1) anaerobic treatment of the pistachio processing wastewater originated from peeling process of outer fresh husk of pistachio in an UASB reactor; and (2) determination of the biogas production during anaerobic treatment process were conducted. Average COD removal efficiencies of four UASB reactors were varying from 73.8 % to 86.74 %. Maximum COD removal efficiency observed in reactor UASB3 as 95.4 %. Average methane yields observed in reactors ranged in between 154 – 305.49 ml CH₄/g COD_{reduced}.

The results revealed that pistachio wastewater can be treated with UASB and biogas can be produced.

Keywords: Pistachio, *Pistachia vera L.*, Anaerobic Treatment, Up-flow Anaerobic Sludge Blanket

ÖZ

ANTEP FISTIĞI ATIK SUYUNUN YUKARI AKIŞLI ÇAMUR YATAKLI ANAEROBİK (YAÇYA) REAKTÖR İLE ANAEROBİK OLARAK ARITILABİLİRLİĞİ VE BİYOGAZ ÜRETİM POTANSİYELİ

Gür, Eray
Yüksek Lisans, Çevre Mühendisliği Bölümü
Tez Yöneticisi: Prof. Dr. Göksel N. Demirer

AĞUSTOS 2016, 93 sayfa

Yüksek organik içeriği olan tarımsal sanayi atıkları, konvansiyonel atık su arıtma tesislerinde arıtmaya uygun değildir. Buna rağmen, bu atıklar yenilenebilir enerji kaynağı olarak kullanılma potansiyelleri yüksektir ve uygun arıtım teknolojileri kullanılmasıyla değerli ürünlere dönüşebilirler. Anaerobik çürütme, organik bileşiklerin oksijen yokluğunda metan ve karbondioksit kadar indirgenmiş bir süreçtir. Bu sebeple, Yukarı Akışlı Çamur Yataklı Anaerobik (YAÇYA) reaktörü gibi iyi anlaşılmış anaerobik biyo-teknolojiler, dünya çapında yaygın olarak kullanılmakta ve sadece arıtım için değil aynı zamanda tarımsal sanayi atıklarının değerlendirilmesinde önemli rol oynamaktadır.

Türkiye’de yılda ortalama 130000 ton Antep Fıstığı üretilmekte ve işleme sırasında 520000 ton atık su ortaya çıkmaktadır. Ancak, bu konuda yapılmış akademik çalışmalar sınırlıdır.

Bu çalışmanın amacı, yerel bir atık olan antepfıstığı işleme atık suyunun anaerobik metotlarla arıtılma verimlerini belirlemek ve bu süreçte ortaya çıkacak biyogazın yenilenebilir enerji üretim potansiyelini belirlemektir. Bu amaçla tez sürecinde yapılan çalışmalar: (1) Antep fıstığı üretim sürecinde, dış yaş kabuğun soyulmasından kaynaklanan atık suyun YAÇYA reaktörü ile arıtılması; ve (2) bu süreçte oluşacak biyogaz üretim potansiyelini belirlemektir. Kullanılan YAÇYA reaktörlerin ortalama Kimyasal Oksijen İhtiyacı (KOİ) arıtım verimleri % 73,8 ile % 86,74 arasında değişmektedir. Elde edilen maksimum KOİ giderim verimi YAÇYA 3’te % 95,4 olarak gözlenmiştir. Reaktörlerde elde edilen metan üretim verimi 154 – 305,49 ml / g KOİ_{giderilen}

aralığındadır. Sonuçlar, antep fıstığı atık suyunun YAÇYA reaktöründe anaerobik olarak arıtılabilir olduğunu ve süreçte biyogazın üretilebilir olduğunu göstermektedir.

Anahtar Kelimeler: Antepfıstığı, *Pistachia vera L.*, Anaerobik Arıtım, Yukarı Akışlı Anaerobik Çamur.

To my grandma (RIP)...

ACKNOWLEDGEMENTS

First of all, I would like to record my deepest gratitude to my supervisor Prof. Dr. Göksel N. Demirer for his valuable advices, guidance and encouragement extended to me.

I wish to express my sincere to my committee members, Prof. Dr. F. Dilek Sanin, Assist. Prof. Dr. Evren Doruk Engin, Assoc. Prof. Tuba H. Ergüder and Assoc. Prof. Emre Alp. I'm very grateful for their feedbacks and valuable recommendations.

I would also like to thank Prof. Dr. Deniz Üner for gaining my life a new standpoint and for being a motivation for returning to the university.

I also thank to my coworkers and lab partners; Ebru Koçak, Çağatay Erşan, İlke Çelik, Mehmet Hamgül, İrem Kocatürk, Cansu Gece Öğüt, Burak Çakırlar from Department of Environmental Engineering for their contribution to my laboratory studies.

I also specially thank to my friends and coworkers Ayşe Özgül Çalıcıoğlu, Emre Hepgüneş, Eren Hepgüneş, Engin Koç, Oya Nihan Uncu Bilau, Nilüfer Demirci Ülgüdür, Elif Küçük for their contribution to my whole study and being motivation for studying.

I want exclusively to thank my son, Oğuz Kağan Gür, with his birth and for being a deep motivation not only for accomplishing this study but also for living.

It is impossible to express how I am thankful to my wife Şebnem Gür. Thank you for your trust and patience. The idiom “Nice to meet you” have never been felt this meaningful since I met with you. Thank you for believing in me, I love you.

Last, but not least, I would like to express my deepest gratitude to my mother Rahime Gür, grandmother Kıymet Uğurman, grandfather Mete Uğurman, father-in-law Dr. Bülent Aşkun and mother-in-law Prof. Dr. Tülin Aşkun for their support and endurance throughout my studies. I am glad to have you.

TABLE OF CONTENTS

ABSTRACT.....	v
ÖZ.....	vii
DEDICATION	ix
ACKNOWLEDGEMENTS	x
TABLE OF CONTENTS	xi
LIST OF TABLES.....	xiii
LIST OF FIGURES	xiv
ABBREVIATIONS.....	xv
CHAPTERS.....	1
1. INTRODUCTION	1
2. LITERATURE REVIEW	5
2.1 Pistachio.....	5
2.1.1 Pistachio Production in the World	6
2.1.2 Pistachio Production in Turkey.....	8
2.1.3 Pistachio Processing in Turkey.....	10
2.1.4 Environmental Impacts of Pistachio Waste	13
2.1.5. Uses of Pistachio Processing Wastes	14
2.2 Anaerobic Digestion.....	15
2.2.1 Stages of Anaerobic Digestion	15
2.2.2 Factors Affecting Anaerobic Digestion	18
2.2.3 Anaerobic Reactors.....	22
2.3. Upflow Anaerobic Sludge Blanket (UASB).....	28
2.3.1. Development of UASB	28
2.3.2. Technical Details of UASB.....	29

2.3.3. Factors Influencing UASB Reactor Performance	33
2.3.4. Treatment of Different Wastewaters with UASB.....	34
2.3.5. Anaerobic Digestion of Pistachio Processing Wastes	37
3. MATERIAL AND METHODS.....	39
3.1 Characterization of Pistachio Waste	39
3.1.1. Chemical Oxygen Demand (COD).....	40
3.1.2. Total Kjeldahl Nitrogen.....	40
3.1.3. Total Phosphorus.....	40
3.1.4. Total Solids.....	40
3.1.5. Volatile Solids	40
3.1.6. Total Suspended Solids	41
3.2 Experimental Design and Setup.....	41
3.2.1. First Setup	41
3.2.2. Second Setup.....	44
3.3 Experimental Analyses	47
4. RESULTS AND DISCUSSION.....	49
4.2. First Setup.....	51
4.2.1. UASB 1	53
4.2.2. UASB 2	59
4.3. Second Setup.....	61
4.3.1. UASB 3	62
4.3.2. UASB 4	68
4.4. Overall Comparison of All Reactors	72
5. CONCLUSION.....	77
FUTURE STUDIES	79
REFERENCES.....	81
APPENDICES.....	93

LIST OF TABLES

TABLES

Table 1. Polymeric matters and their monomers (Schwarzenbach et al., 2005) ...	16
Table 2. Feedstock used in Anaerobic Treatment Applications	22
Table 3. Wastes Treated with UASB	35
Table 4. Characterization of Granular Seed Taken From Anadolu Efes Beer Factory	42
Table 5. Basal Medium (Demirer and Speece, 1998)	43
Table 6. Characterization of Granular Seed Taken From Amasya Özmaya Yeast Factory	46
Table 7. Operational Parameters	47
Table 8. Pistachio Process Wastewater Characteristics (Demirer, 2016)	50
Table 9. Fresh Pistachio Processing WW Characteristics	50
Table 10. Results of UASB1 & UASB2	53
Table 11. Results of UASB3 & UASB4	62

LIST OF FIGURES

FIGURES

Figure 1. Distribution of Pistachio Production in the World (FAOSTAT, 2016)..	6
Figure 2. Total Pistachio Production in the World (FAOSTAT, 2016)	7
Figure 3. Continental Distribution of Pistachio Production (FAOSTAT, 2016) ...	7
Figure 4. Top Five Pistachio Producers of the World (FAOSTAT, 2016)	8
Figure 5. Total Pistachio Production in Turkey (FAOSTAT, 2016).....	9
Figure 6. Flow Scheme of Pistachio Processing (Ocak, 2012)	11
Figure 7. Schematic diagram of carbon flow conversion in anaerobic digestion (Korsak et al., 2008).....	16
Figure 8. Completely Mixed Suspended Growth Anaerobic Digester (Gerardi, 2003)	23
Figure 9. Anaerobic Contact Process (Khanal, 2008)	24
Figure 10. Anaerobic Sequencing Batch Reactor (Dague, 1993)	25
Figure 11. Anaerobic Up-flow Packing Bed Reactor (de Lemos Chernicharo, 2007)	26
Figure 12. AFBR (Sancinetti et al., 2012).....	27
Figure 13. UASB (Chong et al., 2012).....	28
Figure 14. Drawings of UASB 1&2 Reactors and GLS Separators.....	42
Figure 15. Drawings of UASB 3&4 Reactors and GLS Separators.....	45
Figure 16. Water Displacement Device	48
Figure 17. UASB 1	55
Figure 18. UASB 2	58
Figure 19. UASB 3	64
Figure 20. UASB 4.....	69

ABBREVIATIONS

AD	:	Anaerobic Digestion
AEBR	:	Anaerobic Expanded Bed Reactor
AFBR	:	Anaerobic Fluidized Bed Reactor
ASBR	:	Anaerobic Sequencing Batch Reactor
BM	:	Basal Medium
BMP	:	Biochemical Methane Potential
BOD	:	Biochemical Oxygen Demand
COD	:	Chemical Oxygen Demand
DO	:	Dissolved Oxygen
F/M	:	Food-to-Microorganism Ratio
GSL	:	Gas Solid Liquid
HRT	:	Hydraulic Retention Time
LCFA	:	Long Chain Fatty Acids
MSW	:	Municipal Solid Waste
OFMSW	:	Organic Fraction of Municipal Solid Waste
OLR	:	Organic Loading Rate
PGH	:	Pistachio Green Hull
PHP	:	Pistachio Hull Powder
RTD	:	Residence Time Distribution
SLR	:	Sludge Loading Rate
sCOD	:	Soluble Chemical Oxygen Demand
TAN	:	Total Ammonifiable Nitrogen
tCOD	:	Total Chemical Oxygen Demand
TKN	:	Total Kjeldahl Nitrogen
TN	:	Total Nitrogen
TP	:	Total Phosphorus
TS	:	Total Solids
TSS	:	Total Suspended Solids
UASB	:	Up-flow Anaerobic Sludge Blanket
VFA	:	Volatile Fatty Acids
VS	:	Volatile Solids
VSS	:	Volatile Suspended Solids

WAS : Waste Activated Sludge
WW : Waste Water

CHAPTER 1

INTRODUCTION

As a small tree, the pistachio (*Pistacia vera L*) produces seeds that are edible and widely consumed. As a source of mastic, one of the oldest known high grade resins, *Pistachia lenticus*, another pistachio species, has been cultivated since antiquity in Greece and the Greek island of Chios. It is also known as the “mastic tree”. Pistachio is a deciduous tree which grows slowly to a height and spread of 8 – 10 meters. Under inimical conditions, with sparse precipitation and on stony terrain it can survive. Although it cannot tolerate excess humidity and damp, the tree is durable to windy and cold weather. In spite of the vast temperature difference, 45°C in summer and – 10°C during the winter months, it flourishes in some regions of Iran.

With the high demand of the consumers, the pistachio is placed among the most valuable nuts in economic terms, which makes pistachio production a rising trend in the World (Schramm, 2014).

Of the total production of pistachio in the World (Polat et al., 2007; Zheng, 2011), Turkey comes third after Iran and United States with a production of approximately 10.6% (Polat et al., 2007).

Even though pistachio production takes place in 56 cities in Turkey, the leading producers are concentrated in the south-east region of Turkey (Babadogan, 2007). Even the name “Antep nut” comes from the region, Gaziantep, where pistachio is produced the most. Between the years 2007-2009 (TUIK 2012), 94 % of the pistachio produced in Turkey came from south-eastern Anatolia, and 45.44 % of it was produced in Gaziantep region.

In Turkey, around 130000 tons of pistachio is produced in average. The wastewater generation from pistachio processing is around 4 m³ / ton of pistachio paired (Ocak, 2012). That means, 520000 m³ of pistachio processing wastewater is generated in average in a year. The wastewater of the pairing process filtered from 2 – 3 mm sieves.

The retantate of the sieving process is named as pistachio solid waste. 1/5 of the total weight of pistachio is the outer red - green soft husk. That means also 26000 tons of pistachio solid waste is being generated in Turkey in a year.

The energy demand escalated as the population grew uncontrolled, urbanization increased and industrialization accelerated. Currently fossil fuels are the prior source of energy and they will continue to be consumed in a constant and unsustainable way (Park et al., 2010). Using fossil fuels cause harmful after effects such as greenhouse gas emissions, climate change, global warming and serious environmental changes like air pollution (Xie et al., 2008). Aiming to solve these problems and develop a sustainable system, the demand for renewable energy resource is getting higher.

The need for alternative energy and fuels has motivated researchers to focus on renewable and sustainable means of energy production including energy production from wastes such as anaerobic digestion.

Organic wastes are important sources of renewable energy that cannot be underestimated. If not treated, the disposition of these wastes cause air and soil pollution, surface and ground water degradation and greenhouse gas emissions. Organic wastes can be decomposed to biohydrogen or methane via different biochemical systems. Such systems contribute to the environment by reducing greenhouse gas emissions through waste processing and play an important role in the production of renewable/ sustainable energy (Giordano et al., 2010).

One of the most commonly used anaerobic reactors used to process industrial wastewaters with high organic content is Upflow Anaerobic Sludge Blanket (UASB) reactor. In a UASB reactor, a blanket of granular sludge carry out the anaerobic digestion process.

Anaerobic microorganisms forming the sludge blanket (degrade) the organics in wastewater as it flows upwards through it. With this reactor type, the use of granular sludge make good settling and solids/liquids separation possible (Lettinga et al., 1994). UASB reactors are also preferable since they are highly tolerable to toxic shock loads and high Organic Loading Rates (OLRs). This reactor configuration is versatile and has been used for a variety of substrates; cheese whey, olive mill wastewater, olive pomace leachate, potato waste leachate, thin stillage, slaughterhouse wastewater and dairy manure, for treatment and renewable energy production purposes (Speece, 1996).

When it comes to the treatment of organic wastes, anaerobic digestion is both a common solution well known around the world today (Ergüder et al., 2000; Clarke and Alibardi, 2010) and an appealing technique to generate renewable energy (Torres and Lloréns, 2008). Although so many organic wastes were examined as anaerobic substrates and pistachio wastewater is a considerable strong organic waste, anaerobic treatability and biogas production potential of pistachio wastewater were studied only in batch systems (Çelik and Demirer, 2015; Demirer, 2016) but was not investigated in a continuous anaerobic reactor before. Therefore, this is the first study that examines the anaerobic treatability and biogas production potential of pistachio processing wastewater in a continuous anaerobic reactor.

The aim of this study is to determine the anaerobic treatment performance and the biogas production potential of pistachio processing wastewater with UASB reactors. For this purpose, in this study, four lab scale UASB reactors were employed in two setups. The reason for employing UASB reactors in this study is the advantages of UASB reactors in treating industrial wastewaters (Kaviyarasan, 2014). These advantages can be summarized as highly efficient COD removal performance of UASB reactors and being able to operated at both mesophilic and thermophilic conditions. Due to the fact that UASB is a well-known technology for high strength industrial wastewaters; the previous modeling approaches and kinetics derived so far for UASB reactors can also be applied in order to improve the COD removal performance of the system and also biogas production potential.

The wastewater, taken from Tadım Pistachio Processing factories' pairing process, were characterized and sieved. The reactors were fed once in two days and COD, produced biogas volume and gas composition measurements were also done once in two days.

In second setup UASB reactors upgraded, new pumps were used, different granules were employed, Hydraulic Retention Time (HRT) of the system were changed from 4 to 5.4 days and Basal Medium (BM) usage was limited (In UASB 3 only alkalinity addition was applied).

CHAPTER 2

LITERATURE REVIEW

2.1 Pistachio

The seeds of the small tree called the pistachio (*Pistacia vera L*) are commonly consumed as food. The family *Anacardiaceae*, which the *pistachio* is a member, houses also cashew, mango, sumac and poison oak. Many of the about a dozen *pistachio* species exude turpentine or mastic and some produce small nuts. The larger and edible *pistachio* which is acceptable as a commercial product is only produced by *pistachia vera*. The name *pistachio* was derived from the Persian name of these nuts “*pisteh*”. As a source of mastic, as a high grade resins known to man in earliest times, another *pistachia* species, the *Pistachia lenticus*, has been cultivated in Greece and the Greek island of Chios since ancient times (Rosengarten Jr, 2004). The evidences found in Djarkutan, Uzbekistan indicate that pistachio is consumed as food since the Bronze age (Potts, 2012).

As a deciduous tree, the *Pistachia vera L*. can grow up to 8 m and spread 10 m slowly. It is durable to dry and adverse conditions. It can live even without rainfall for the most of the year on stony terrain. While it can endure low temperatures and wind, it is not tolerable to excessive dampness and humidity. Some regions of Iran constitute productive lands for pistachio, where the temperatures differ from 45° C in summer to – 10° C during the winter months.

Pistachio is one of oldest food known to men. There had been archaeological excavations in a very early Neolithic settlement which thrived about nine thousand years ago, in Hashemite Kingdom of Jordan, north of Petra, in Beidha. A series of well-preserved plant impressions were found in one of the excavations from one of the antique residences. It was evident that the residence was destroyed by a ferocious fire since clay, mortar and

plaster from roof and mud-brick walls were baked and solidified. Inside the residence, a heap of carbonized pistachio nuts, which are estimated to have been in a large basket and weigh around 18 kg originally, were found on the floor in excellent condition. Carbonized pistachio nuts found at Beidha date back to 6750 B.C. according to the radio-carbon date calculated by the Copenhagen Radiocarbon Laboratory, making them one of the oldest original recorded edible nuts (Rosengarten Jr, 2004).

2.1.1 Pistachio Production in the World

Figure 1 shows the distribution of the pistachio production in the World. Although the origin of the pistachio is Middle East and Anatolia, it spreads to all Mediterranean countries and then to the World.

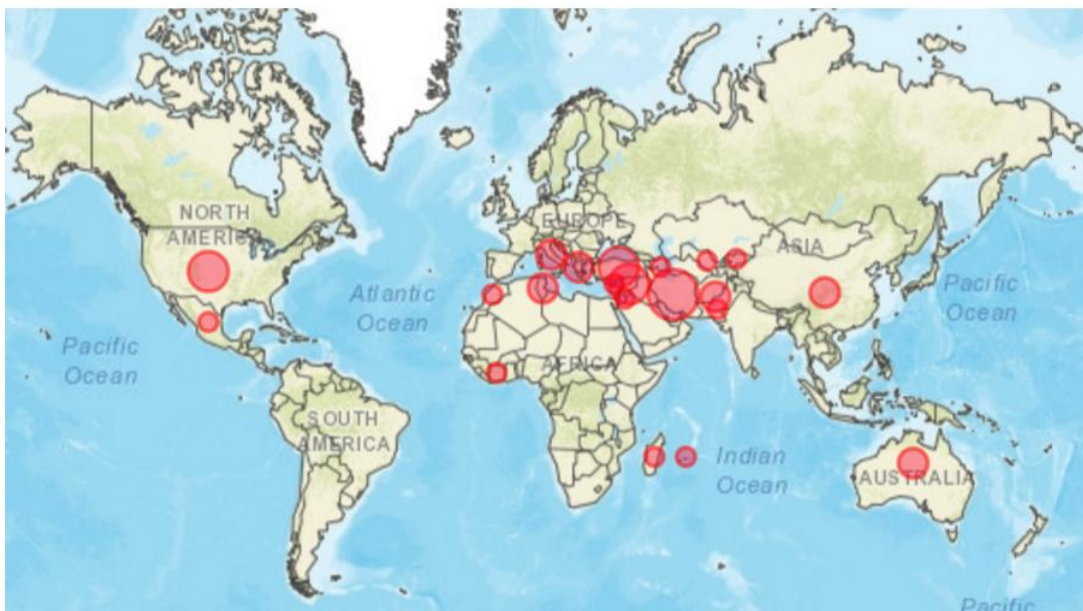

Figure 1. Distribution of Pistachio Production in the World (FAOSTAT, 2016)

Total pistachio production of the World is shown in Figure 2. Today pistachio's popularity among the consumers renders it to be one of the most important nuts in terms of economic value. Therefore, the pistachio production has a rising trend in the world (**Figure 2**).

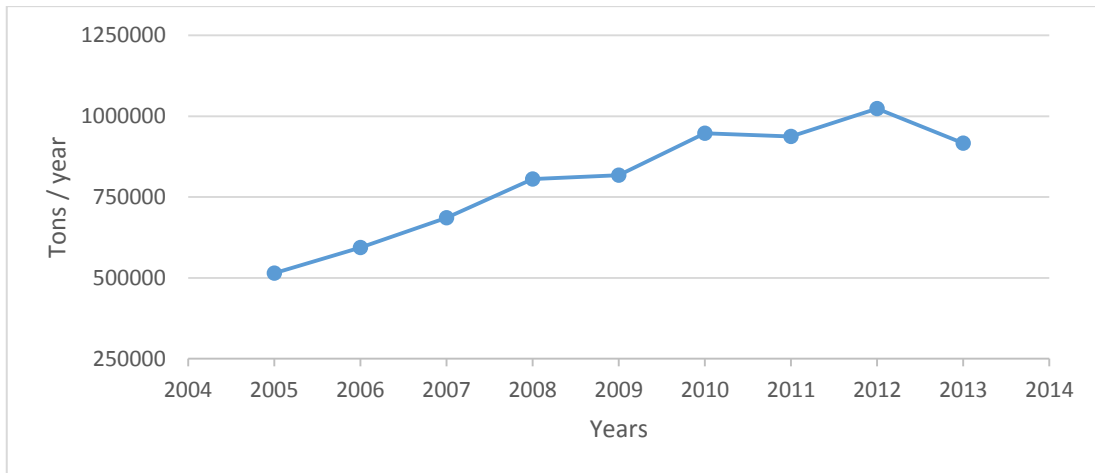

Figure 2. Total Pistachio Production in the World (FAOSTAT, 2016)

Today, the continental distribution of the pistachio production for years 2005 – 2013 is depicted in Figure 3. Asia is producing 75.9 % of the pistachio in the World. This percentage is resulted from the fact that the countries Iran, Turkey, Syria, and China are located in Asia. These are the four of the top 5 pistachio producers (**Figure 4**). In the continent America, almost all of the production is made by USA. USA is the second biggest producer in the world with a production of 177463.7 tons of pistachio per year between 2005 and 2013.

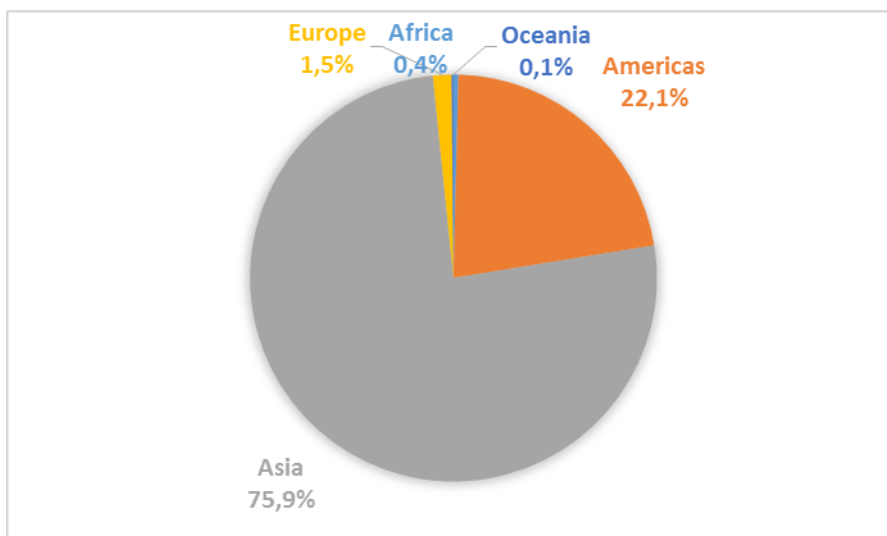

Figure 3. Continental Distribution of Pistachio Production (FAOSTAT, 2016)

The top five pistachio producers of the World is given in Figure 4. Islamic Republic of Iran is the world's biggest pistachio producer with 395321.3 tons/year in average. Iran produce 478600 tons of pistachio in 2013 and with this production, Iran supplies almost 52 % of total pistachio production in World alone.

Turkey produces approximately 10.6% of the total pistachio (*Pistacia vera L.*) production in the World (Polat et al., 2007) . Average production value of 102658.7 tons/year between 2005 and 2013 makes Turkey the third largest producer in the World, after Iran and United States (Polat et al., 2007; Zheng, 2011). Turkey produced 88600 tons of pistachio in 2013 and saved its place of third biggest pistachio producer in the World.

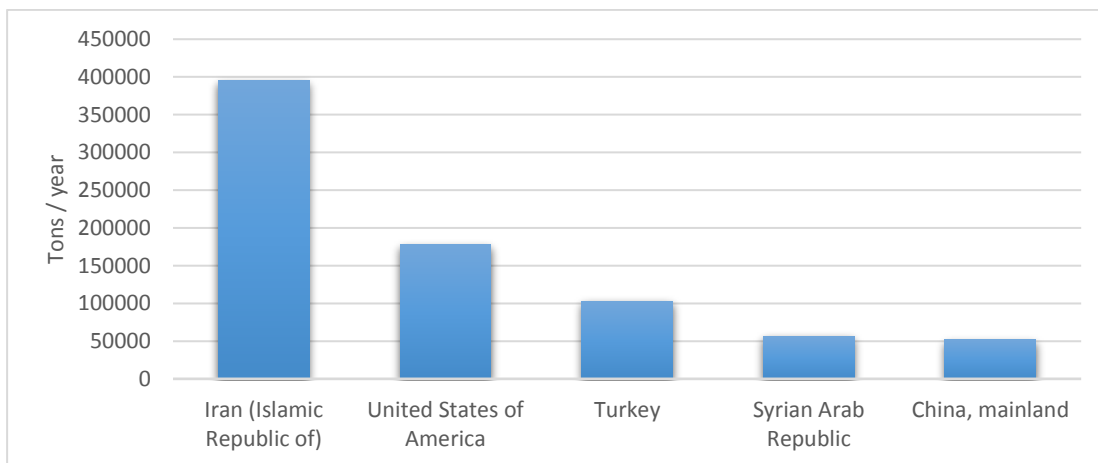

Figure 4. Top Five Pistachio Producers of the World (FAOSTAT, 2016)

2.1.2 Pistachio Production in Turkey

Although pistachio is produced in 56 cities in Turkey, it is mainly concentrated in the South-Eastern Anatolia (especially Gaziantep region) possessing 84 % of total pistachio industry of the country (TUIK 2012). It's the climatic and geographic qualities this region namely dry and hot summers and short and moderately warm winter conditions, that meet the requirements of efficient pistachio production (Babadogan, 2007). In fact, in Turkey, pistachio is named after the region it is produced the most, Gaziantep, as “Antep nut”. 94 % of pistachio production of Turkey is accomplished in South-Eastern Anatolia with Gaziantep region controlling % 45.44 of the whole production in Turkey between the

years 2007-2009 (TUIK 2012). Moreover, these facts render the city and its surroundings to be the processing and trade center of pistachio in the country.

Figure 5 shows the total pistachio production in Turkey in years between 2005 and 2013. The up and down pattern seen in the production trend is originated from the characteristic properties of the pistachio trees. As many other trees (many fruits such as olive, etc.), pistachio trees give more products in one of two years. This is named as ‘On year & Off Year’ in pistachio natural production cycle. The reason of the dramatic drop in 2013 was the weather conditions especially frost in March and April.

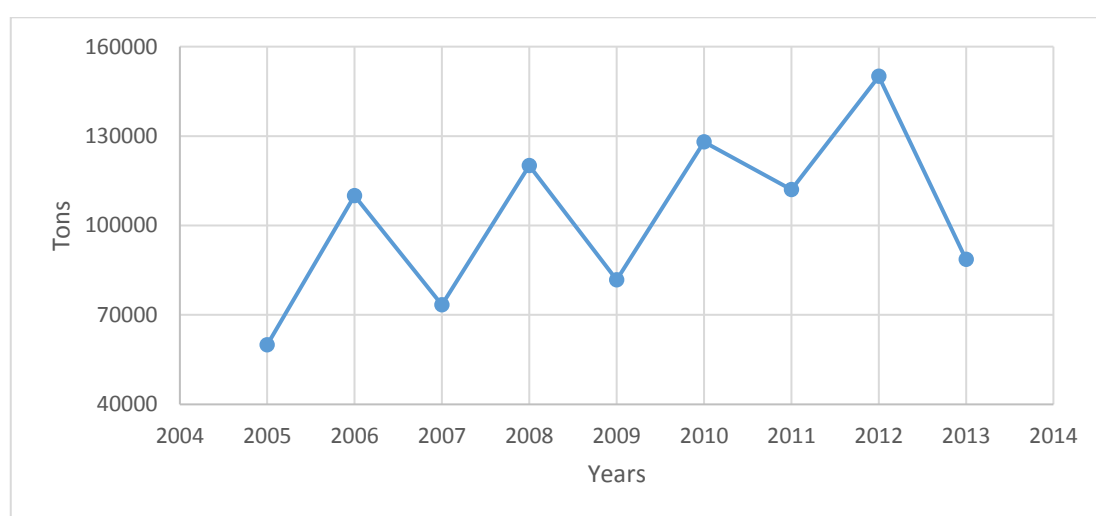

Figure 5. Total Pistachio Production in Turkey (FAOSTAT, 2016)

Most of the Turkey's crop is consumed domestically and consumption varies from year to year, according to availability of pistachio on the market. Traditionally, the Turkish people consume 35 percent of total production as a snack food and the rest are used in the production of confectionery, chocolate products, especially in desserts and bakery products. Packaging of tree nuts, including pistachios, has doubled over the last few years throughout the country, especially in the coastal regions (Aegean, Mediterranean and Marmara). Packaging mitigates food safety and quality concerns related to high humidity in these regions. Currently, 35 percent of total tree nuts are being packaged, while it was 15 percent few years ago. It is forecasted that the packaging of tree nuts, including pistachios, will increase consumption. Current per capita consumption is 0.6 kg/year in

Turkey. However, higher prices in the last two years have slowed the increase in consumption (Schramm, 2014).

Turkey is self-sufficient in pistachios and a minor amount of total production goes to exports. Although there is no legal barrier to pistachio imports, there are always less import than the market requires, especially during “off year” production periods. Because marketing year 2013 as an “off year” and prices were high, imports doubled in marketing year 2013 to 13,000 Tons. Exports in marketing year 2013 were considerably less than the previous year. Italy is still the primary export market for Turkish pistachios. Other significant markets include Israel, Saudi Arabia, Hong Kong and North African countries such as Egypt and Libya (Schramm, 2014).

2.1.3 Pistachio Processing in Turkey

Processing of pistachio is still performed with the conventional method. The first phase of the pistachio processing is paring. The fruit is collected from trees and the outer humid husk (pistachio hull) is pared with water. After this stage, pistachio are classified as open and closed, hard shell is cracked if it is closed and then roasted (**Figure 6**).

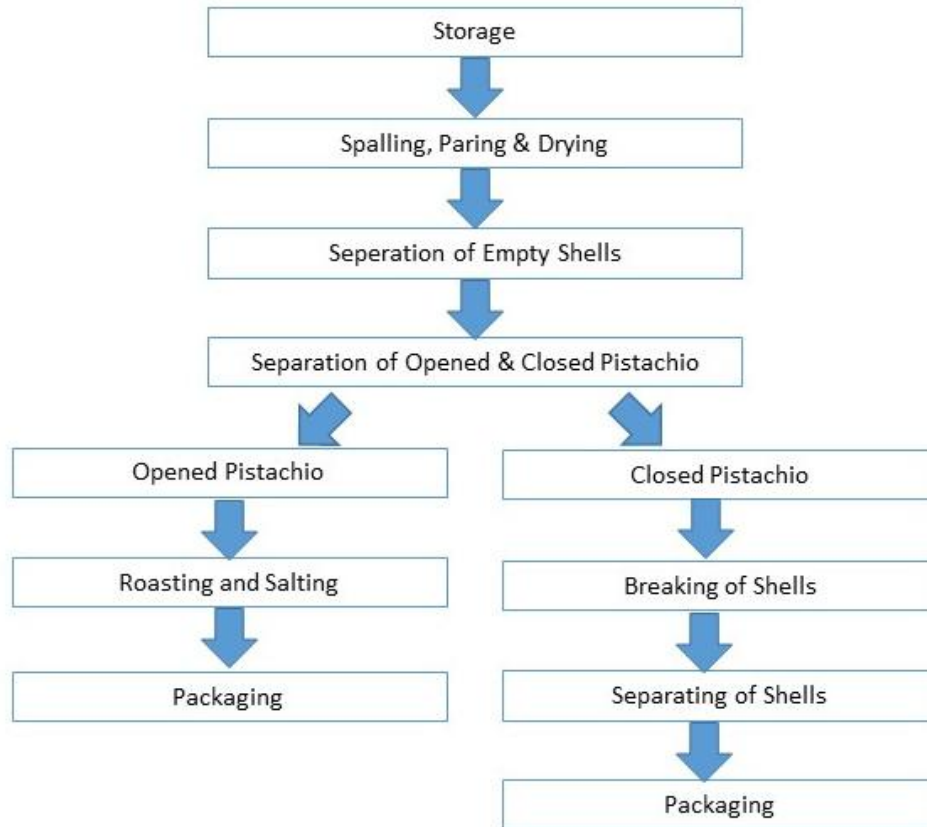

Figure 6. Flow Scheme of Pistachio Processing (Ocak, 2012)

2.1.3.1 Storage

Reaping period of pistachio is between Mid-August to early days of September. Pistachio is reaped, dried and stored. After reaping, pistachio is spread out and dried in sun for a few days. After drying, it is stored. (**Figure 6**)

2.1.3.2 Spalling, Paring and Drying

Although the reaping period is between August and September, pistachio production is a continuous process. Pistachio is spalled with water or steam for a few hours and then given to the paring machine. After paring, pistachio is washed and dried with hot air to a moisture content of 6-7 %. Almost all the wastewater of pistachio production is generated in this stage (**Figure 6**).

2.1.3.3 Separation of Empty Shells

Sometimes pistachio fruit may not grow. The red husk and shell is grown but the fruit is not. So after paring of red husk, separation of empty shells is needed. The main reasons of this are lack of male trees, apiculturing and other kind of fruits in near orchards, or climatological effects (**Figure 6**).

2.1.3.4 Separation of Opened and Closed Shells

Some of the shells are opened during processing and some of them are not. In most races of pistachio, 50 – 70 % are opened. Both mechanical and manual techniques are used to open the closed ones. In Turkey opening process is made by hand. A worker can open around 15 - 20 kg of pistachio in 1 day. A cracking machine which has been invented locally in Gaziantep can open 210 – 400 kg of pistachio in 8 hours (Ocak, 2012).

2.1.3.5 Roasting and Salting

Pistachio trade is mainly done in two ways. First one is as dried fruit. Pistachio grows as bunches. The outer ones grow faster than inner fruits and they fall from trees firstly. These are considered the most delicious pistachios of the season and are traded as dried fruits. The first harvest is traded as dried fruit directly without passing through any process. The others are mostly used in chocolates, halvas or different kind of desserts. The processes mentioned above are used for the second type of pistachios. Insignificant amount of water is also used in the salting process. According to information taken from “TADIM Kuruyemiş” Gaziantep pistachio factory, salt is used in 1/4 ratio of pistachio produced in terms of weight and the amount of wastewater generated in this process is not significant (Ocak, 2012).

2.1.4 Environmental Impacts of Pistachio Waste

In Turkey, around 130000 tons of pistachio is produced in average. 1/5 of the total weight is pistachio hull. As wastewater generation 1 m³ for spalling, 4 m³ for paring and 0.3 m³ of water for washing is used for processing 1 ton of pistachio. The spalling water can used many times and washing water can be reused in paring process directly (Ocak, 2012). In average, 520000 m³ of pistachio processing wastewater and also 26000 tons of pistachio solid waste is generated in Turkey in a year (Ocak, 2012; FAOSTAT, 2016).

For now, according to the information taken from TADIM Pistachio Factory, factories filter their wastewater from 2 - 3 mm sieves and give it to the sewer system (Ocak, 2012). The solid waste from the sieves is sand to landfill.

The pistachio waste has high solids concentration with high organic and phenolic content. When the by-products of pistachio are considered, the most abundant ingredient is the pistachio epicarp (53.5% of dry matter) followed by peduncles, leaves, mesocarp and kernel (27.7%, 9.5%, 5.3% and 4.0% of dry matter, respectively) of the pistachio plant. All of these by-products are obtained during the deshelling stage of the production. The green hull of the plant is shown to be a rich source of nutrients such as protein, fat, mineral salts, vitamins, one of the richest sources of antioxidant, phenolic compounds and essential oil such as a-pinene and alpha-terpinolene (Goli et al., 2005; Chahed et al., 2008). However, it is generally treated as agricultural waste, often mixed with soil or used to feed cattle and ovine by local livestock farmers. Additionally, it is known to be used as herbal medicine and human foods (mainly as pistachio hull jam) although to a lesser extent. Some important characteristics of the pistachio hull such as chemical composition, phenolics content, etc. vary and greatly depend upon the pistachio cultivar (Bohluli et al., 2010), harvesting time, drying and de-hulling processes (Behgar et al., 2011). This fact poses considerable problems of waste management which require careful planning and implementation of waste management solutions.

2.1.5. Uses of Pistachio Processing Wastes

In literature, there are some studies that pistachio processing wastes and residuals were examined and evaluated for potential uses.

In Iran, pistachio green hull was employed as absorbent in order to remove cyanide from a syntactic wastewater (Moussavi and Khosravi, 2010) and also cationic dyes from aqueous solutions (Moussavi and Khosravi, 2011). Moussavi and friends claim that pistachio hull powder (PHP) was capable of reducing a high concentration of cyanide ions (up to 200 mg/L) in a relatively short contact time with a low amount of adsorbent (Moussavi and Khosravi, 2010) and also they conclude that hulls produced as an agriculture waste material are a viable and very promising alternative adsorbent for color removal from industrial wastewater (Moussavi and Khosravi, 2011).

Also in another study in Iran, Kazemi and coworkers, tried to use Pistachio Green Hull (PGH) as a substrate for furfural production and showed that PGH is a lingo-cellulosic material and have good potential for furfural production (Kazemi and Zand-Monfared, 2010).

PGH's antioxidant activity was also examined in different studies. Rajaei and coworkers reported that PGH can be used as a cheap and easily accessible source of natural bioactive compounds and PGH aqueous extracts presents a strong antioxidant activity, inhibition of the growth of the different pathogenic bacteria (Gram+) and anti-mutagenicity that can causes health problems (Rajaei et al., 2010). Also Goli and coworkers claim that the PHE possess antioxidant properties and could be used as alternative natural antioxidants (Goli et al., 2005).

In Turkey, pistachio soft shell was analyzed for biofuel production. In the study, Demiral et. al. conducted in Eskişehir Osmangazi University in 2008, pyrolysis of pistachio soft shell was carried out in a fixed-bed reactor and the bio-oil produced from pistachio soft shell was identified and presented as a bio-fuel candidate, that may be used as a source of low-grade fuel directly, or it may be upgraded to higher quality liquid fuels by the

application of various processes (such as cracking, hydrogenation, etc.) (Demiral et al., 2008).

Although there are some studies considering pistachio processing wastes and residuals as a by-product, they are not implemented widely. Thus, pistachio processing wastes and residuals are a significant threat to the environment. Most of the pistachio processing solid waste is ended in landfills. The pistachio processing wastewater is discharged directly to the natural receiving environments or into the sewer system bringing a heavy load to the conventional wastewater treatment plants of the local municipalities.

2.2 Anaerobic Digestion

When it comes to the treatment of organic wastes, anaerobic digestion is both a common solution (Ergüder et al., 2000; Clarke and Alibardi, 2010) and an appealing technique as a form of renewable energy around the World today (Torres and Lloréns, 2008). Anaerobic digestion (AD) can be defined as a process that involves decomposition of organic matter, which can be referred as substrate, in molecular oxygen-free environment. As a result of this process, methane, carbon dioxide and inorganic nutrients are produced and the organic matter is converted into biogas (McCarty, 1964). Biogas contains 20-30 % CO₂, 60-79 % CH₄, 1-2% of hydrogen sulfide (H₂S) and other gases (Parkin and Owen, 1986).

2.2.1 Stages of Anaerobic Digestion

AD process is comprised of various steps, each of which involves specific anaerobic bacterial flora. These consecutive steps are (i) hydrolysis, (ii) acidogenesis, (iii) acetogenesis and (iv) methanogenesis, which are further explained in this section. Schematic diagram of carbon flow conversation in anaerobic digestion is given in Figure 7.

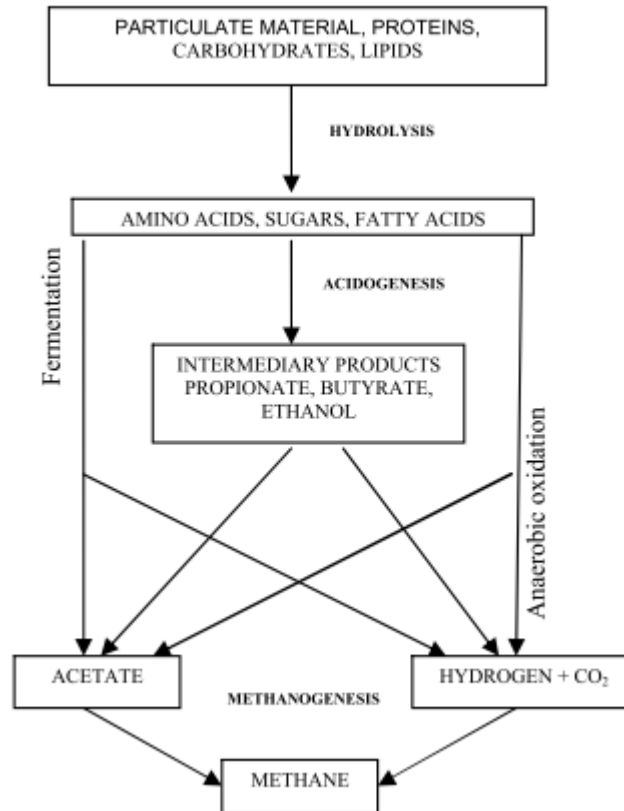

Figure 7. Schematic diagram of carbon flow conversion in anaerobic digestion (Korsak et al., 2008)

2.2.1.1 Hydrolysis (Liquefaction)

Hydrolysis is the first stage of AD process, which involves conversion of insoluble organic matter into soluble forms such as sugars, amino acids and long chain fatty acids (LCFA), i.e. decomposition of complex polymeric organics into monomers.

Table 1. Polymeric matters and their monomers (Schwarzenbach et al., 2005)

Polymeric Matter	Monomers
Lipids	Fatty Acids
Polysaccharides	Monosaccharide
Protein	Amino Acids
Nucleic Acids	Purines & Pyrimidines

Liquefaction of organic matter is an important stage, as can be rate limiting in systems with high organic contents. Pretreatment alternatives such as chemical addition can be applied to facilitate this stage (Verma, 2002).

2.2.1.2 Acidogenesis

In the second stage, acid formers, convert the products of the first phase to simple organic acids, carbon dioxide and hydrogen. The principal acids produced are acetic acid (CH_3COOH), propionic acid ($\text{CH}_3\text{CH}_2\text{COOH}$), butyric acid ($\text{CH}_3\text{CH}_2\text{CH}_2\text{COOH}$), and ethanol ($\text{C}_2\text{H}_5\text{OH}$) (Verma, 2002).

2.2.1.3 Acetogenesis

Fermentative acetogenic bacteria convert volatile fatty acids synthesized in the previous phase into hydrogen, acetate and carbon dioxide. Elevated hydrogen concentrations cause inhibition of methane formation and increase in organic acid concentrations, therefore play an essential role in methane formation (Parkin and Owen, 1986).

Acetogens are slow-growing bacteria and not resistant to abrupt organic load or physical changes (Parawira et al., 2004).

2.2.1.4 Methanogenesis

Methanogens produce biogas via simultaneous utilization of the end product of previous stage. Methanogens are strictly anaerobic organisms which are sensitive to environmental conditions (McCarty, 1964; Speece, 2008). Methane is produced by bacteria called methane formers (also known as methanogens) in two ways. It has been done either by cleavage of acetic acid molecules to generate carbon dioxide and methane, or by reduction of carbon dioxide with hydrogen (Equations 1, 2, 3). Reduction of carbon dioxide results in higher methane production, but when the hydrogen concentration in digesters is limited, the acetate reaction becomes the primary source of methane production (Omstead et al., 1980). Methanogen organisms include: *Methanobacterium*, *methanobacillus*,

methanococcus and *methanosarcina*. These organisms can also be classified into two groups as acetate consumers and H₂/CO₂ consumers. The species of *Methanosarcina* and *Methanothrix* (also, *methanosaeta*) are significant in AD both as acetate and H₂/CO₂ consumers.

The methanogenesis reactions can be expressed as follows (Verma, 2002)

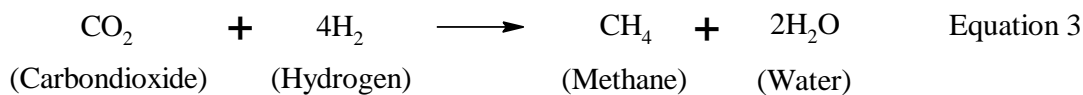
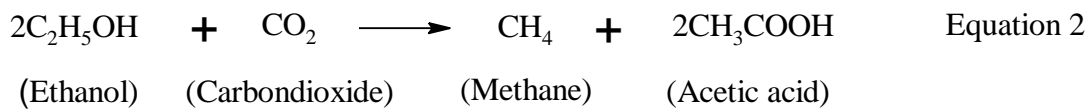
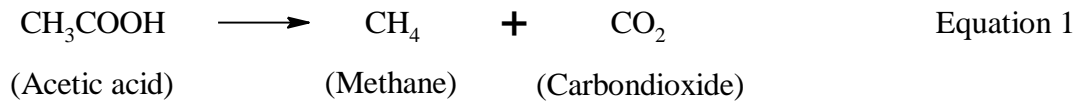

2.2.2 Factors Affecting Anaerobic Digestion

Efficiency of anaerobic digestion (AD) process has a direct relation with balanced microbial activity. In this section, AD process parameters, that should be restrained in order to provide optimum growth conditions for microbial flora, will be discussed.

2.2.2.1 Nutrients

Not only aerobic microorganisms but also anaerobic ones utilize organic and inorganic nutrients for growth and maintenance. Primarily, adequate amounts of nitrogen (N) which is mainly responsible for amino acid and protein synthesis and phosphorus (P), to be used for nucleic acid synthesis and energy should be provided in a balanced AD process (Speece, 2008). Optimum range of element ratios in an AD process were found to be between 20:1 to 30:1 for C:N (Yen and Brune, 2007) and 5:1 to 7:1 for N:P (Parkin and Owen, 1986).

In AD process, another important parameter for measuring nutrient medium utility is COD:N:P ratio. For systems with low organic load, a ratio of 350:7:1 (COD:N:P) is often recommended, however for systems with high organic load, nutrient requirement increases and the ratio becomes 1000:7:1 for COD:N:P. If waste has immense amount of biodegradable material, together with high C:N or COD:N ratios can result in accelerated acidification in AD process.

Besides, if C:N or COD:N ratios are low in an AD digester, ammonia can accumulate, toxicity can occur and process can be inhibited (Speece, 2008). In anaerobic systems with high ammonia concentration, which depends on total concentration of free ammonia and ammonium ion, pH, temperature and pressure, free ammonia (NH_3) causes toxification. Free ammonia concentration increases with increasing pH and temperature, however it decreases with increasing pressure due to formation of CO_2 . Systems without acclimatization, even a concentration of 80 to 200 mg/L free ammonia can inhibit the process. Inhibition is not only related with free ammonia but also with total ammonia concentration. Total ammonia concentrations in the range of 1.5 - 7 g/L are found to be toxic. But, if the process is adapted, it can endure concentrations up to 3-4g/L (Nielsen and Angelidaki, 2008).

Apart from nitrogen (N) and phosphorus (P), elements like iron (Fe), nickel (Ni), cobalt (Co), sulfur (S) and calcium (Ca), together with trace elements are required in small quantities.

An anaerobic system usually requires lower amount of nutrient than an aerobic system. Nonetheless, external nutrient addition can be necessary for an anaerobic system in rare cases. (Speece, 2008)

2.2.2.2 pH

Different species of microorganisms which are mostly acid-intolerant are involved in an AD process. Microorganisms responsible of biogas production mainly belong to three groups, which are: Hydrolysis bacteria, acid forming bacteria and methane forming bacteria. Acid forming bacteria, as the name indicates, tolerate acidic pH however the optimum pH for this type is between 5.0 and 6.0. Specifically, growth of methanogens is directly related with the pH of environment. Optimum pH values are found to lie between 6.6 and 7.6 for an AD process (McCarty, 1964). Moreover, methane forming bacteria has the optimum pH range of 6.7 - 7.4. If the reactor operates out of approximate neutral range (pH 6.0 - 8.0), the activity of methanogenic bacteria decreases, resulting in lower reactor efficiency. The pH drop caused by acid forming bacteria can be controlled by the bicarbonate which is formed as a result of methanogenic activity or added externally (Liu and Tay, 2004).

Immense amounts of organic acid degradation lowers pH values (less than 6.0) and inhibits activity of methanogenic microorganisms. This can be overcome by buffering the system.

Bicarbonate system is mainly the source of alkaline conditions in AD process which provides a buffer and prevents pH decline. In contrary, if alkalinity is high in the process, it can also enhance ammonia toxicity (Parkin and Owen, 1986). An alkalinity range of 2000-4000 mg/L is enough to maintain pH around 7.0 (Soller et al., 2003).

2.2.2.3 Temperature

Psychrophilic (0-20 °C), mesophilic (30-38 °C) or thermophilic (50-60°C) temperature ranges can be applied in AD process (McCarty, 1964) and conventional anaerobic digesters are mainly run in mesophilic range (Parkin and Owen, 1986).

2.2.2.4 Toxicity

The concentration and acclimatization of a substance define its toxic potential in a system. In general, variety of substances can be endured and mild concentration levels, but as concentration increases, their potential to inhibit also increase. Substances which can cause toxicity in AD process include: Sodium, potassium, calcium, magnesium, copper, chromium, nickel, ammonia, formaldehyde, chloroform, sulfide, ethyl benzene, ethylene dichloride, kerosene, alkali and alkaline earth-metals, heavy metals and detergents. However, microorganisms can increase their tolerance against toxic substances via acclimatization (Parkin and Owen, 1986).

2.2.2.5 Organic Loading Rate

The organic loading rate (OLR) is defined as the flux of organic matter fed to the system. The unit of OLR is $\text{kg/m}^3/\text{d}$ (Zhou and Mancl, 2007). The degree of microbial nutrient deprivation depends on OLR. At low OLR, microorganisms starve in contrary to high OLR conditions at which rapid growth is observed. The latter condition can also lead to intoxication due to excessive organic matter (Liu and Tay, 2004).

For a fast start-up, OLR can be regulated to yield 80% of COD reduction in an UASB system (Fang and Chui, 1993). On the other hand, if OLR is regulated at a too high value, the biogas can be produced at increasing rate, resulting in increased agitation, which finally may be able to cause sludge washout (Liu and Tay, 2004).

2.2.2.6 Food to Microorganism Ratio

Ratio of chemical oxygen demand (COD) to volatile suspended solids (VSS), in other words, food to microorganisms' ratio (F/M) is defined as probable nutrient availability for microorganisms (Droste, 1997). F/M is significant in terms of biodegradation of waste (Grady, 1985). It was stated by Prashanth et al. (2006) that high F/M ratio can cause toxicity however too low F/M ratio can hinder enzyme induction and adversely affect biodegradation (Prashanth et al., 2006).

Table 2 summarizes some of the feedstocks that are commonly digested in anaerobic biological treatment systems (Yilmazel, 2009).

Table 2. Feedstock used in Anaerobic Treatment Applications (Yilmazel, 2009)

Type of feedstock	Reference(s)
Waste activated sludge	(Bolzonella et al., 2005; Demirer and Othman, 2008; Romano and Zhang, 2008)
Organic fraction of municipal solid waste	(Hartmann and Ahring, 2005; Dogan et al., 2009)
Domestic wastewater	(Monroy et al., 2000; Ergüder and Demirer, 2008)
Fruit and vegetable wastes	(Bouallagui et al., 2005)
Animal manure	(Güngör-Demirci and Demirer, 2004; Demirer and Chen, 2005; Karim et al., 2005)
Sugar industry wastes	(Hutnan et al., 2001; Farhadian et al., 2007)
Pulp and paper industry wastes	(Grover et al., 1999; Tezel et al., 2001)
Food waste	(Kim et al., 2006)

2.2.3 Anaerobic Reactors

The main AD processes used for wastewater treatment are classified into two groups: Suspended growth processes and attached growth (biofilm) processes. The principle behind these processes relies on microbial activity, and this activity is affected by certain reactions, reaction kinetics, nutrient utilization, and environmental factors (Soller et al., 2003).

2.2.3.1 Suspended Growth Treatment Processes

Microorganisms are suspended in anaerobic digester as a result of mixing, in suspended growth systems. There are four types of anaerobic suspended growth systems, these are:

(1) Completely Mixed Suspended Growth Anaerobic Digester

This type digesters are the basic type of anaerobic digesters. First type of process does not let recycling and concentration of biomass. Thus, sludge retention time (SRT) and hydraulic retention time (HRT) are equivalent. Suspended growth anaerobic digesters are commonly used at municipal wastewater treatment plants for the degradation of primary and secondary sludge. These digesters produce several layers as a result of sludge degradation. These layers are from top to bottom: biogas, scum, supernatant, active biomass or sludge, and stabilized solids (Gerardi, 2003). This type of process can be used in handling dilute toxic waste, soluble and colloidal waste and crude waste. But, completely mixed suspended growth anaerobic digester process requires extensive volume to fulfill the necessary sludge retention time (SRT) (Gerardi, 2003).

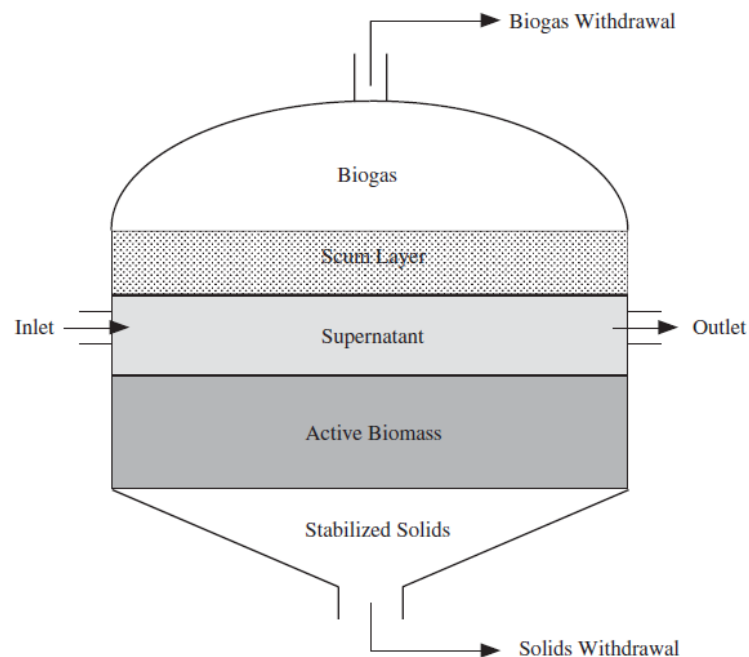

Figure 8. Completely Mixed Suspended Growth Anaerobic Digester (Gerardi, 2003)

(2) Anaerobic Contact Process

In anaerobic contact process, processed water and sludge are separated and latter one is recycled to the reactor, so a reactor of smaller volume can be used and HRT is shorter than SRT.

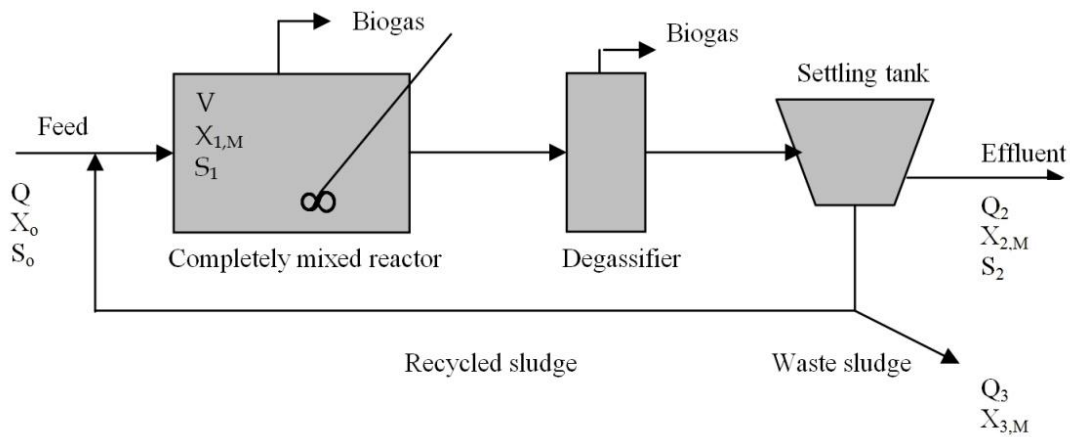

Figure 9. Anaerobic Contact Process (Khanal, 2008)

(3) Anaerobic Sequencing Batch Reactor

In anaerobic sequencing batch reactor (ASBR), the reaction and separation occur simultaneously in the same reactor. In an ASBR process there are four stages: Feeding the system, reaction, settling and removal of effluent (Soller et al., 2003). Efficiency of effluent withdrawal is directly related with atomized sludge and fine settling in ASBR.

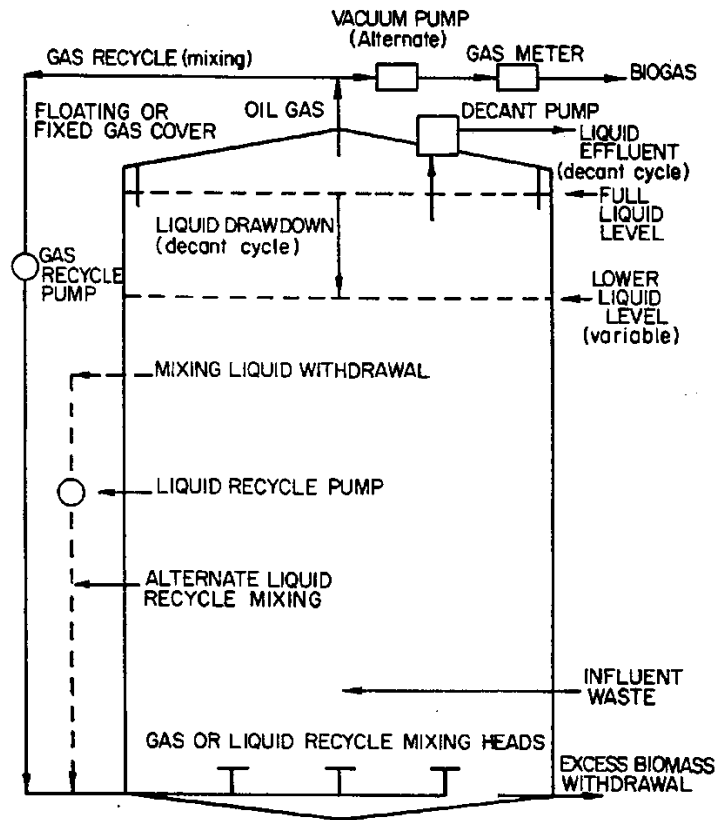

Figure 10. Anaerobic Sequencing Batch Reactor (Dague, 1993)

2.2.3.2. Attached Growth Anaerobic Treatment Reactors

There are four types of up-flow attached growth anaerobic reactors:

- 1) The Anaerobic Up-flow Packed Bed Reactor: Packing material is stabilized and the wastewater flows through the packed bed covered by the biofilm. Rock or synthetic plastic can be used as packing material.

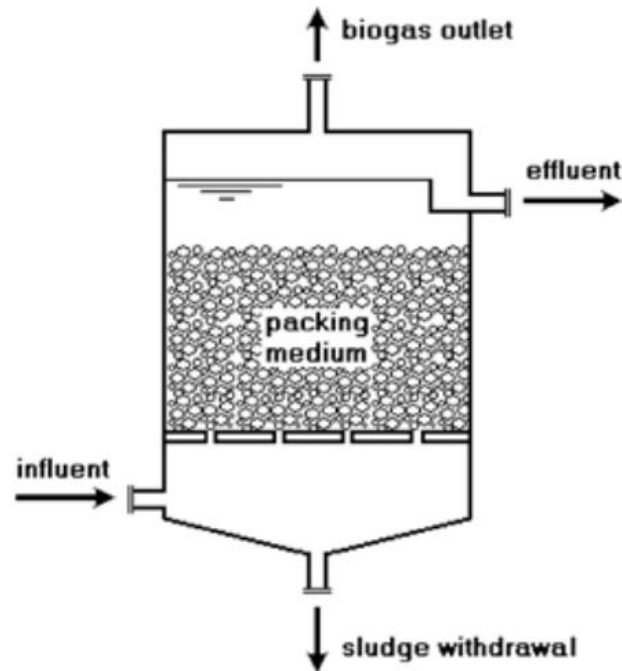

Figure 11. Anaerobic Up-flow Packing Bed Reactor (de Lemos Chernicharo, 2007)

2) The Anaerobic Expanded Bed Reactor (AEBR): It uses fine-grain sand as packing material in biofilm growth. System includes recycle stream to obtain required up flow velocities. The bed can expand up to 20 percent of its initial volume.

3) The Anaerobic Fluidized-Bed Reactor (AFBR): Fluidization and mixing take place at the same time. The FBR works at an up flow velocity of 20 m/h, approximately. The bed can expand 100 percent in this type of reactor (Soller et al., 2003; Korsak et al., 2008).

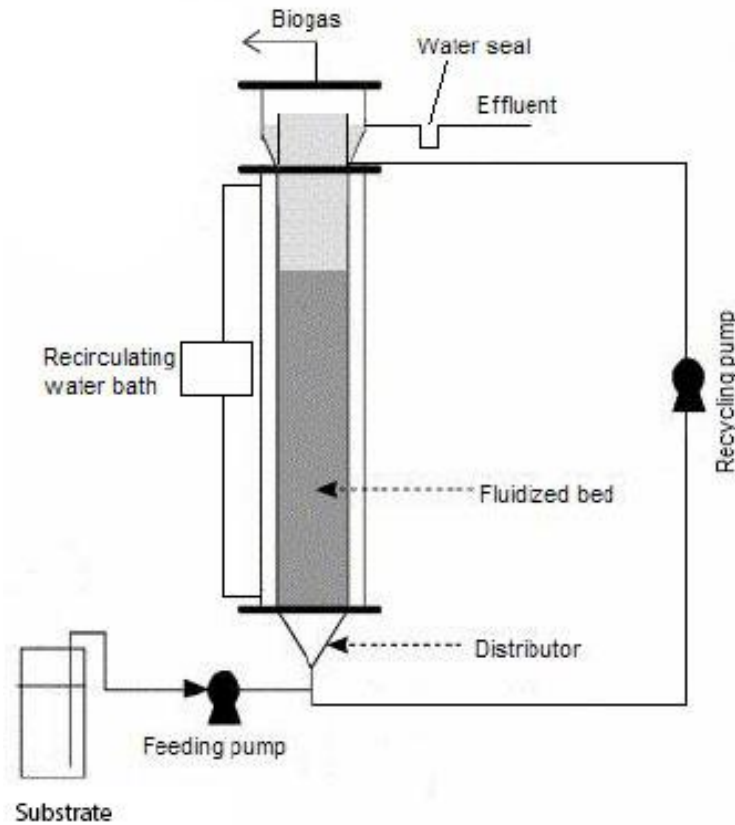

Figure 12. AFBR (Sancinetti et al., 2012)

4) The up-flow anaerobic sludge blanket (UASB).

Up-flow anaerobic sludge blanket reactor (UASB) is one of the most commonly used anaerobic reactor. UASB was developed in Netherlands by Lettinga and his colleagues in the second half of 1970's. Forming a dense atomized sludge is the key of UASB operation. UASB is consist of granular sludge (**Figure 13**). Any other packing material is not needed in UASB reactors. Sludge concentration can be in the range of 5-40 g/L at the top of the reactor and two to ten times higher at the bottom (50-100 g/L). Greater COD load can be applied than other AD processes due to the formation of sludge layer (Lettinga et al., 1980).

Detailed information about UASB is given in part 2.3. UASB.

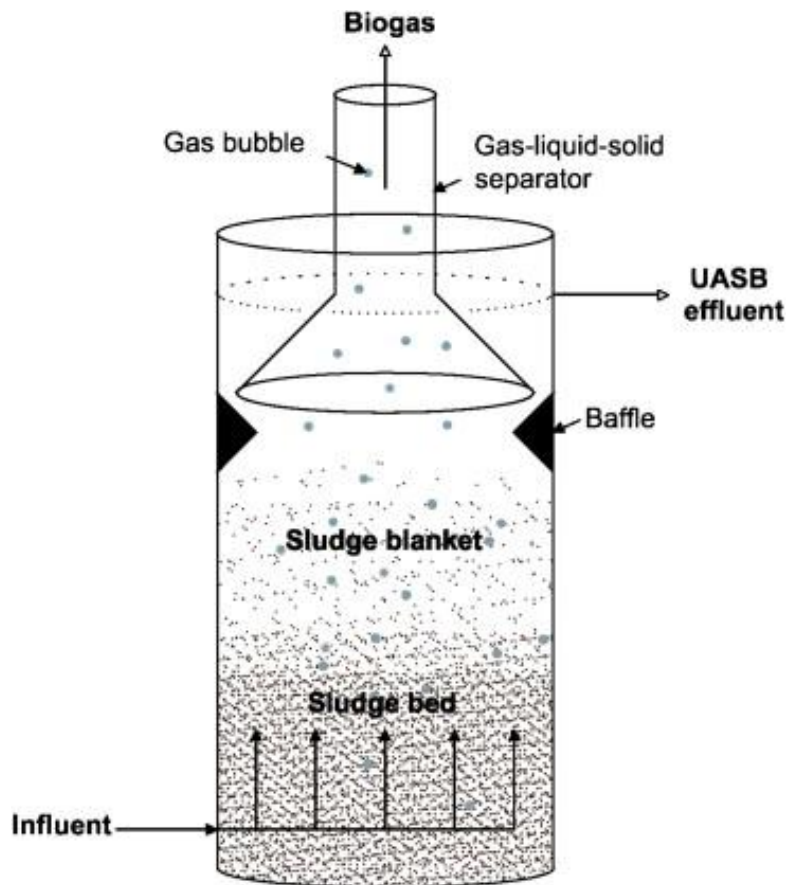

Figure 13. UASB (Chong et al., 2012)

2.3. Upflow Anaerobic Sludge Blanket (UASB)

2.3.1. Development of UASB

The UASB process was developed by Lettinga and co-workers in the late 1970's (Lettinga et al., 1980). UASB reactors were developed to treat wastewater of different sources, and they occupy an important place in anaerobic technology by providing a high efficiency. The UASB concept is clear and uncomplicated. An UASB reactor has a single inlet through which the wastewater is fed to the system, and it flows upward passing through an anaerobic bed containing semi-immobilized microorganisms. Important parts of an UASB system are the solid-gas separator, circulation of the feed and dropping out of efflux. The key of UASB system is the design of the sludge bed, where the digestion of wastewater organic material takes place as biogas is being formed.

The biogas formed in digestion zone creates a hydraulic turbulence when flowing upward in the reactor. By doing so, it provides necessary agitation in the reactor without any need of additional mixing. The 3-phase separator disassociates liquid phase (water) from solids and gas, which is placed at the top of an UASB reactor and enhances detainment of granules (Lettinga, 1995).

Suspended solids which are introduced to the system accumulate in the reactor and generate the sludge bed where bacteria grow. When conditions are favored in up-flow anaerobic medium, bacteria commonly amass themselves and form granules and flocs (Lettinga, 1995).

2.3.2. Technical Details of UASB

The size of the granulated sludge particles ranges from 1.0 to 3.0 mm in diameter (Chou and Huang, 2005; Veronez et al., 2005; Vlyssides et al., 2008; Yetilmezsoy and Sakar, 2008). Since these aggregates have much higher settling velocities (20-80 m/h) than the up-flow velocities (0.1-1 m/h), large biomass quantities can accumulate at the bottom. In this way, a high sludge loading rate (SLR) can be applied (up to 5 g COD / g VSS / day) with a relatively short hydraulic retention time (HRT), less than 4 hours (Kalyuzhnyi et al., 2006).

In an UASB reactor, depending upon the concentration levels of accumulated compounds in the reactor; three distinct zones can be observed which are: A viscous sludge bed zone at the bottom containing accumulated biomass, a layer covering the sludge bed and containing suspended solids and the third zone of treated water without any solids in the inner part (Kalyuzhnyi et al., 2006). The solids concentration can range from 50 to 100 g/L at the bottom and 5 to 40 g/L in a more diffuse zone at the top the UASB sludge blanket (Soller et al., 2003).

A removal efficiency of 90 to 95 percent for COD has been achieved at COD loadings ranging from 12 to 20 g COD / l / d on a variety of wastes at temperatures from 30 to

35°C (Lettinga, 1995). This loading rates agrees with a survey of 682 full/scale installations that reported that the average loading rate was 10 g of COD / l/ d (Frankin, 2001).

Even the principle of an UASB reactor is simple; the reactions taking place within the reactor are very complicated. In the sludge bed, the efflux and granulated material form a solid-liquid system which is in the form of dispersion at up-flow velocities between 0.1-1.0 m/h (Zeng et al., 2005). Nonetheless, the biogas formed creates a perturbation and solid-liquid systems turns out to be solid-liquid and gas, which can change the hydrodynamic behavior of the system. The up-flowing biogas can negatively affect the complete performance of the system. Although it provides a fine mixing within the reactor, it also causes some biomass to be lost due to turbulence and launching. It is found that; biogas provides higher agitation than the up-flow velocities in the system (Gonzalez-Gil et al., 2001).

Changes in hydraulic rate directly affect the efficiency of the treatment operations due to two reasons one of which is associated with hydraulic retention time (HRT). At high wastewater feeding rates, the water goes through the bed fast enough to hinder the organic matter utilization. However, high speed can enhance agitation and improve the mass transfer rate, resulting in an increase in reactor's performance.

As mentioned above, UASB system improves granulated material formation which contains high amount of microorganisms in a gram of biomass. None of these microorganisms alone is able to decompose the organic matter in the wastewater. The overall decomposition of the substrates is due to the combined effect of many species (Liu and Tay, 2002).

It is crucial to keep the optimum conditions for anaerobic granules to grow and well function, if it is aimed to reach a desired level of degradation. The organic loading rate (OLR) must be high enough to prevent microbial starvation and low enough to control the growth (Bitton, 1999).

Biofilm theory is the most commonly used method to study organic matter decomposition in the granules. This theory states that substrate transport rate in the film layer controls the conversion rate in degradation. When the film layer reaches a certain thickness, it limits mass transfer and some capacity remains unused in the reactor and influent and/or effluent streams determine the reaction rate (Gonzalez-Gil et al., 2001).

Substrate is carried via flow in the liquid phase. A boundary layer has been formed near biofilm surface and at the boundary the flow behavior shifts to laminar. Mass transfer occurs via diffusion between the turbulent region in the liquid phase and laminar region at the surface. Substrate is transported by molecular diffusion in the biofilm layer. If the rate of substrate diffusion in the film and from the surface to the bulk liquid are equal, substrate does not accumulate on film surface (Christiansen et al., 1995).

There are many studies on the effect of mass transfer on substrate utilization in anaerobic medium. It is also found that external mass transfer does not limit an anaerobic process under normal conditions (up-flow velocity greater than 1m/h) (Gonzalez-Gil et al., 2001). However, the decrease in mass transfer resistance in the bulk liquid and lower mass transfer coefficients combined with higher up-flow velocity can improve agitation in the reactor. The effect of the flow velocity may then be attributed to the reduction of preferential channeling of the influent wastewater and not to any direct effect on transport phenomena in the anaerobic biofilm. Moreover, it has to be underlined that biogas production is much more effective than up-flow velocity on the agitation (Gonzalez-Gil et al., 2001).

The main transport mechanism in the biofilm is molecular diffusion, in other words internal mass transfer. Brito and Melo (1999) stated that, internal mass transfer coefficient remains constant in laminar flow region, without being affected by hydrodynamic state of the liquid phase (Brito and Melo, 1999). Moreover, Ting and Huang (2006) claimed that internal mass transfer resistance must be considered because it is related to total nitrate removal rate in an UASB system (Ting and Huang, 2006). Kitsos (1992) also found that at steady-state, diffusivity in an anaerobic film is lower than that in water (Kitsos et al., 1992).

Gonzales-Gil (2001) stated that, concentration of biomass and size of granulated matter strongly affects the relative substrate uptake rate (Gonzalez-Gil et al., 2001). Huang (2003) studied the relation between granule size and reaction kinetics in an UASB system (Huang et al., 2003). They found that, when UASB reactor operates at high up-flow velocity, the distance between bulks liquid and solid-liquid interface decreases which results in increased discharge of COD and bigger granules.

Yan (1997) define an UASB reactor as a “high-rate methane bioreactor with a sludge bed, or blanket of settled microorganisms through which the wastewater flows upwards” (Yan and Tay, 1997). The primary asset of a UASB system is that, the highly dense anaerobic sludge does not require any support for holding (Lettinga et al., 1980; Elias et al., 1999; Zoutberg and Eker, 1999). Nonetheless, presence and sustainability of precipitable biomass, either in the form of granules (0.5 to 2.5 mm in diameter) or flocs, are required due to lack of vector compounds (Callander and Barford, 1983; Lettinga, 1995). There is no need for pumps to recycle the efflux in a UASB system (Lettinga and Pol, 1991; Rajeshwari et al., 2000). Since UASB reactors have high-density structure and the sludge within the reactor is very dissoluble, they work well at high up-flow velocities without sludge washout (Lettinga and Pol, 1991; Zoutberg and Eker, 1999).

However, there are also some challenges and disadvantages of a UASB system, especially if the influx rate is low and the influent are not well distributed. If the system is fed too fast or if biogas is produced intensely, the bed may be perturbed. Then, the UASB reactor cannot treat the granules and reactor’s performance drops. Other disadvantage is that, to start-up the process rapidly, sludge should be particulate. However, UASB system requires less cost than fluidized bed or anaerobic filter systems. Moreover, it is normal to face sludge washout at the start-up of the process, therefore experience is needed while operating.

Higher OLR’s are possible in UASB reactors than flocculent sludge bed reactors (Lettinga et al., 1982). In a flocculent sludge bed reactor, if there is not enough degradable organic matter in the wastewater, activity of methanogenic bacteria rapidly

decreases due to the entrapped dissolved solids. Besides, the drop in methanogenic activity is irreversible and expected granulation cannot be achieved.

A seed sludge must involve the necessary microbial flora to function well in an UASB reactor (Tay and Zhang, 2000). Sludge granules grow if there is enough acetate, propionate, and butyrate in the medium. In mesophilic range, sludge granules can be classified into three types. Classification is based on the utilization of acetate substrate by the methanogens bacteria (Lettinga et al., 1984):

1. Rod-type granules: Consist of rod-shaped bacteria in fragments of four to five cells, (i.e. *Methanothrix*).
2. Filament-type granules: Consist of long multicellular rod-shaped bacteria.
3. Sarcina-type granules: Developed in the presence of high acetic acid concentration.

2.3.3. Factors Influencing UASB Reactor Performance

UASB reactor performance depends on several factors such as pH, temperature, nutrients, toxicity, OLR, F/M ratio, HRT and up-flow velocity.

Effects of nutrients, pH and temperature in UASB are same to all other anaerobic treatment reactors and explained in Section 2.2.2. Effects of OLR in UASB reactors are also given in Section 2.3.2. (Technical Details).

2.3.3.1. Hydraulic Retention Time (HRT) and Up-Flow Velocity

The hydraulic retention time (HRT) is defined as the “time that the influent water remains inside the reactor” (Bitton, 2005). The up-flow velocity is “the liquid velocity crossing a transverse-cross section of the UASB reactor” whose units are $\text{m}^3 / \text{m}^2 / \text{h}$. An increase in the up-flow velocity may cause a decrease in the fixed film surrounding a granule. It is aimed to decrease the mass transfer resistance in the bulk liquid surrounding the granule. Thus, mass transfer between bulk liquid and granule will increase by also increasing the

substrate utilization and growth of the bacteria. The range of up-flow velocity is 0.1-1.4 m/h (Kalyuzhnyi et al., 2006; Korsak et al., 2008). In an UASB reactor, both the blanket and the sludge bed have dissolved particles, and wastewater to be refined flows upward through them together with the formed biogas. So, even the influx wastewater is fed at a slow rate, flow behavior cannot be uniform because of the mixing caused by biogas and the existence of granules. All of these, regulates the “residence time distribution” (RTD). There are many studies on predicting the hydraulic conditions within an UASB system, in which residence time distribution (RTD) tests were applied (Levenspiel, 1999; Borroto et al., 2003; Singh et al., 2006; Atmakidis and Kenig, 2009). In the study of Atmakidis and Kenig (2009), resident time distribution in a fixed bed reactor was investigated via tracer and post-processing method. Tracer method suggests injecting an inert tracer into the reactor, whereas the post-processing method is based on velocities and measures the residence time distribution directly from them. Atmakidis and Kenig (2009) concluded that, both methods yielded close results and there is no significant difference between them. However, the post-processing method has an advantage over the trace method, which is the minor requirement for computational time.

2.3.4. Treatment of Different Wastewaters with UASB

World facing severe problems of collection, treatment and disposal of effluents due to rapid industrialization and urbanization. UASB is one of the anaerobic treatment reactors that converts the waste water organic pollutants into small amount of sludge and large amount of biogas as a source of energy (Hampannavar and Shivayogimath, 2010). UASB is applicable for treating variety of industrial wastewaters like, sugar industry waste water, dairy waste water, textile waste water, slaughterhouse waste water, oil industry waste water, potato processing waste water, distillery waste water and domestic wastewater (**Table 3**).

Table 3. Wastes Treated with UASB

Type of WW	Influent COD (g/l)	OLR (g COD / l/d)	HRT (d)	COD Removal Eff (%)	Methane Production or Yield (l CH ₄ /d)	References
POME	42.50	10.63	4.00	96.00	6.90	(Borja and Banks, 1994)
POME	30.60	30.00	1.02	90.00	7.00	(Borja et al., 1996)
POME	50.00	15.50	3.33	80.50	7.00	(Chaisri et al., 2007)
POME		5.8 gvs/l/d	5.00	>90	436 (ml CH ₄ /g vs)	(Fang, Sompong, et al., 2011)
POME deoiled		2.6 gvs/l/d	5.00		600 (ml CH ₄ /g vs)	(Fang, Sompong, et al., 2011)
Recalcitrant Distillery	10.00	19.00	0.53	67.00	3.50	(Harada et al., 1996)
Malt whiskey	20.92	17.20	1.22	92.00	238.00 (ml CH ₄ / g COD)	(Uzal et al., 2003)
Grape wine Distillery	30.00	18.00	1.67	90.00		(Wolmarans and De Villiers, 2004)
Grain Distillation	5.10	18.40	0.28	90.00		(Laubscher et al., 2001)
Winery	6.40	5.10	1.25	86.00		(Keyser et al., 2003)
Potato		2.5/5.1	4 / 10		240 (ml CH ₄ /g vs)	(Fang, Boe, et al., 2011)
Potato	5.30 / 18.10	14	0.6 / 6	75.00		(Kalyuzhnyi et al., 1998)
Potato	20.3	1.5 / 6.1	13.2 / 2.8	93.00	230 (ml CH ₄ / g COD)	(Parawira et al., 2006)
Olive mill	5	0.33 / 1.67	3	35 / 70		(Katsoni et al., 2014)
Olive mill	40	8	5	80 / 85	300 (ml CH ₄ /g COD)	(Sabbah et al., 2004)
Dairy	37.00	6.20	6.00	98.00		(Gavala et al., 1999)

Table 3 Cont.						
Dairy	79.00	7.50	0.66	74.00	16.00	(Nadais et al., 2006)
Dairy	13.50	22.00	2.00	97.00	54.00	(Nadais et al., 2005)
Dairy	12.48	12.48	1.00	90.00		(García et al., 2008)
Digested cowdung slurry	1.80	13.50	0.13	90.00		(Ramasamy et al., 2004)
Cheese whey	55.10	11.10	4.95	95.00	424 (ml CH ₄ /g COD)	(Ergüder et al., 2001)
Cheese whey		0,5 / 28.5	2.5 / 10.5	>95		(Kalyuzhnyi et al., 1996)
Cheese whey	37.00	6.20	6.00	98.00		(Gavala et al., 1999)
Cheese whey - Dairy Manure	35.30	20.90	2.20	95.75	13,2 (l CH ₄ /l/d)	(Rico et al., 2015)
Dairy Manure	16.5-20.43	8.90	2.00	84.90	368 (ml/ g COD)	(García et al., 2008)
Mixed Sardine & Tuna Canning	2.72	8.00	0.33	80 / 90		(Palenzuela-Rollon et al., 2002)
Slaughterhouse Waste	1.20	3.50	0.33	70.00	6500.00	(Sayed et al., 1984)
Poultry Slaughter	5.50	28.70	0.19	95.00		(Chávez P et al., 2005)
Slaughterhouse Waste	4.20	4.60	0.92	89.00		(Caixeta et al., 2002)
Slaughterhouse	2.87	30.00	0.10	90.00	280.00	(Torkian et al., 2003)
Piggery Waste	8.12	1.62	5.00	75.00	2.37	(Sanchez et al., 2005)
Domestic WW	0.39	1.21	0.32	85.00		(Behling et al., 1997)
Municipal WW	3.20	1.05	0.42	86.00	1.10	(Singh and Viraraghavan, 1998)

2.3.5. Anaerobic Digestion of Pistachio Processing Wastes

Anaerobic treatability and biogas production potential of pistachio wastewater were studied only in batch systems by our research group (Çelik and Demirer, 2015; Demirer, 2016). These studies indicated that anaerobic digestion can be an attractive option not only for the management of pistachio processing wastes, but also producing renewable energy in the form of biogas (Demirer, 2016).

It's reported by Demirer that pistachio processing solid waste and mixtures in various ratios was anaerobically digestible in varying levels of performance such that one liter of pistachio processing wastewater which has a COD concentration of 30 g/l produced 0.7 liters of methane, one liter of pistachio processing wastewater which has 20 g addition of pistachio de-hulling solid waste produced 1.25 liters of methane and one gram of pistachio de-hulling solid waste produced 62.6 ml of methane (Demirer, 2016).

Also pretreatment studies for pistachio de-hulling solid waste were conducted. Çelik and Demirer indicated that in chemical pre-treatment of pistachio de-hulling processing solid waste NaOH and HCl were used and 13 – 26.4 % and 4.4 – 6.2 % of solubilisation of COD achieved, respectively in chemical pre-treatment. Thermal pre-treatment studies were conducted by using an autoclave at 121 °C and 15 Psi for two different time periods, namely 5 and 15 min were used, which provided COD solubilisation values of 1 ± 0.86 % and 4.50 ± 1.27 % respectively for 5 and 15 minutes and an oven at 121 °C for two different time periods, namely 5 and 15 min were used and for oven pre-treatment and 0.50 ± 0.37 % and 2.30 ± 1.11 % of COD solubilisation achieved respectively for 5 and 15 minutes thermal treatment. (Çelik and Demirer, 2015). After pre-treatment studies Biochemical Methane Potential (BMP) tests were also conducted and it was reported that both COD removal values and observed methane yields were improved relative to raw samples from 13.1 – 35.7 % to 36.2 – 54.9 % and from 42.2 – 73.4 ml CH₄ / g COD to 78.5 – 213.4 ml CH₄ / g COD respectively (Çelik and Demirer, 2015).

CHAPTER 3

MATERIAL AND METHODS

This chapter covers the material and methods, and experimental procedures of the study. As mentioned in Section 2.1.2 (Pistachio Industry in Turkey), in this study the wastewater, which is generated in the pairing stage of pistachio and filtered from 2 -3 mm sieves was examined. In this study, main tasks conducted were characterization of pistachio wastewater, setting up and operating the UASB reactors, effluent characterization and biogas measurement. As it is explained in Section 3.2, four UASB reactors were used in the experiments.

The feeding process was done at two-day intervals. Pistachio processing wastewater, stored in the refrigerator, used for experiments. After COD analysis of pistachio wastewater, it is diluted for the organic loading rate (OLR) adjustment and BM or alkalinity was added. Pistachio processing wastewater was fed to the UASB reactors after the preparation stage complete.

3.1 Characterization of Pistachio Processing Wastewater

First step of the study was characterization of the pistachio processing wastewater. The wastewater was produced in pistachio paring process and taken from TADIM Gaziantep Pistachio Processing Factory. Before being used the wastewater was filtered from 2 mm pore size course filter. The retantate and filtrate of filtering process was named as solid waste and wastewater, respectively. The characterization studies were conducted by the measurement of Chemical Oxygen Demand (COD), Total Kheldal Nitrogen (TKN), Total Phosphorus (TP), Total Solids (TS), Volatile Solids (VS), Total Suspended Solids (TSS), Volatile Suspended Solids (VSS) parameters for wastewater and Soluble Chemical Oxygen Demand (sCOD), Total Chemical Oxygen Demand (tCOD), TS, VS for solid waste. The methods employed were described in the following sections.

3.1.1. Chemical Oxygen Demand (COD)

Two main methods are used in COD determination tests. For solid waste standard methods 5220 B : Open Reflux Method (APHA, 2005) was used. For wastewater COD analysis EPA approved reactor digestion method (for COD range of 0-1500mg/l) (Hach Water Analysis Handbook, 2012). For wastewater COD analysis Aqualytic AL 38 heater and PC Multidirect Spectrophotometer (program 130-131) were used.

3.1.2. Total Kjeldahl Nitrogen

TKN analysis are done by standard methods 4500-Norg B. Macro Kjeldahl Nitrogen method (APHA, 2005).

3.1.3. Total Phosphorus

TP analysis are done by standard methods '4500-P F. Automated Ascorbic Acid Reduction Method'(APHA, 2005).

3.1.4. Total Solids

TS determination are done with standard methods '2540 B Total Solids Dried at 103–105°C method. (APHA, 2005)

3.1.5. Volatile Solids

Volatile Solids analyses are done by standard methods '2540 E Fixed and Volatile Solids Ignited at 550°C' method.

3.1.6. Total Suspended Solids

For determining TSS value, standard methods ‘ 2540 D. Total Suspended Solids Dried at 103–105°C’ (APHA, 2005) method is used.

3.2 Experimental design and setup

Lab-scale UASB (Up-flow Anaerobic Sludge Blanket) reactors were used in the experiments. Study includes two experimental setups. Two different granules, two different HRTs and two different reactor models were used to control the applicability of UASB reactors for the anaerobic treatability of pistachio processing wastewater and biogas producing potential. In second setup, the HRT was adjusted as 5.4 days, the closest to the first setups HRT which was 4 days, in the constraints of the pump. In both setups two UASB reactors were employed. The reactors in the first and second setups were named as UASB 1 and UASB 2 and UASB 3 and UASB 4, respectively.

3.2.1. First Setup

In first setup, two UASB reactors (**Figure 14**), with 700 ml effective volumes, were employed. The granular anaerobic sludge taken from Anadolu Efes Beer Factory wastewater treatment plant were used as seed in both reactors. Characterization of the granules taken from Anadolu Efes Beer Factory is given in Table 4. Cole Parmer Masterflex C/L peristaltic pumps were used to feed the reactors.

Table 4. Characterization of Granular Seed Taken From Anadolu Efes Beer Factory

Parameters	Granules from Anadolu Efes Beer Factory
tCOD (mg/l)	25469 ± 218
TS (mg/l)	26354 ± 311
VS (mg/l)	21032 ± 108
VS/TS (%)	79.8
TKN (mg/l)	985 ± 35
TP (mg/l)	562 ± 48

The dimensions of the first two reactors were given in **Figure 14**.

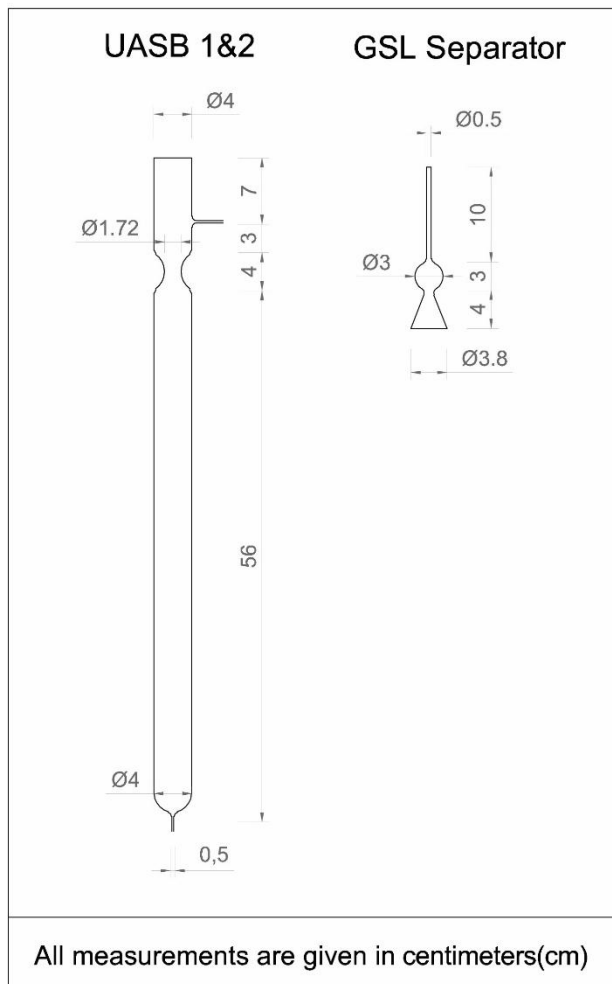

Figure 14. Drawings of UASB 1&2 Reactors and GLS Separators

HRT of the UASB reactors were 4 days in the first setup of experiments. Two replicate reactors were prepared and started to be fed with pistachio processing wastewater which was diluted with distilled water in the ratio of 1/8. The corresponding OLR was 1 g/l/d. The granules were acclimated to the feed with gradually increasing the OLR.

Basal Medium (BM) containing most of the micro and macro nutrients needed for an optimum anaerobic microbial growth was used only in one of the reactors to observe its effect on the performance of the reactor thus to determine the necessity of supplementing basal medium. The content of the basal medium is given in **Table 5**:

Table 5. Basal Medium (Demirer and Speece, 1998)

Chemical Formula	Chemical Name	Concentration (mg/l)
NH ₄ Cl	Ammonium Chloride	1200
MgSO ₄ •7H ₂ O	Magnesium Sulfate Heptahydrate	400
KCl	Potassium Chloride	400
Na ₂ S•9H ₂ O	Sodium Sulfide Nonahydrate	300
CaCl ₂ •2H ₂ O	Calcium Chloride Dihydrate	50
FeCl ₂ •4H ₂ O	Ferrous (II) Chloride Tetrahydrate	40
CoCl ₂ •6H ₂ O	Cobalt (II) Chloride Hexahydrate	10
KI	Potassium Iodide	10
MnCl ₂ •4H ₂ O	Manganese(II) Chloride Tetrahydrate	0.5
CuCl ₂ •2H ₂ O	Copper(II) chloride dihydrate	0.5
ZnCl ₂	Zinc chloride	0.5
AlCl ₃ •6H ₂ O	Aluminum chloride hexahydrate	0.5
NaMoO ₄ •2H ₂ O	Sodium molybdate dihydrate	0.5
H ₃ BO ₃	Boric acid	0.5
NiCl ₂ •6H ₂ O	Nickel(II) Chloride Hexahydrate	0.5
NaWO ₄ •2H ₂ O	Sodium tungstate dihydrate	0.5
C ₃ H ₇ NO ₂ S	Cysteine	10
NaHCO ₃	Sodium bicarbonate	6000

Basal medium was not used in the start-up of the reactors due to the fact that earlier experimental work in our laboratory to determine the Biochemical Methane Potential pistachio wastes revealed that treatment efficiency and methane yield were not improved by adding Basal medium input at lower COD concentrations. Basal medium addition was started after the influent COD concentration of the wastewater reached to 10000 mg/l.

3.2.2. Second Setup

In second experimental setup, two UASB reactors were used. In the first setup, the effluent weir was rarely blocked because of the washout granules. When the effluent weir is blocked, the effluent filled into the gas collecting bags. Therefore UASBs were redesigned and used in the second series of the experiments. Effective volume of the reactors were expanded from 700 ml to 2 l, one more baffled section was added therefore, baffled section had been extended. Effluent weir was also enlarged (**Figure 15**).

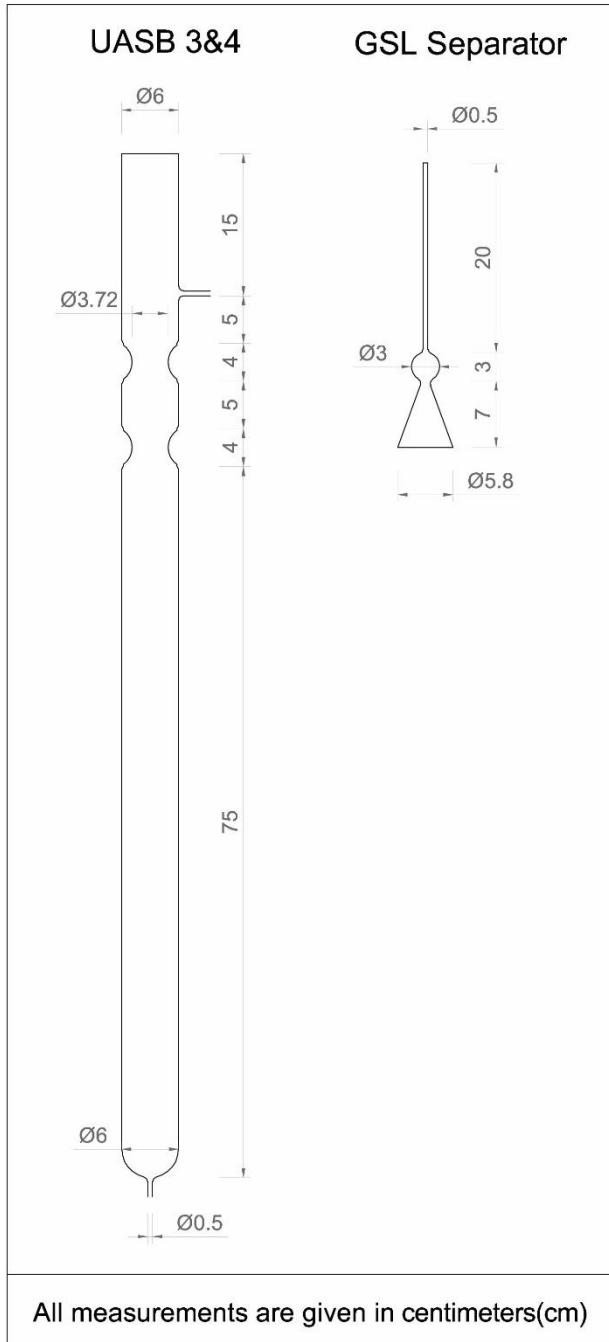

Figure 15. Drawings of UASB 3&4 Reactors and GLS Separators

In first setup of experiments Cole Parmer Masterflex C/L pumps were used. Since the flow adjustment is manual in the Masterflex C/L pumps, it was hard to adjust the flow in small scale. In second series pumps were changed with Watson Marlow 120 U pumps. In small flows, Watson Marlow 120 U pumps was easier to manage and more accurate than the Cole Parmer Masterflex C/L pumps.

In this experimental setup, the granules taken from Amasya Özmaya Yeast Factory Wastewater Treatment Plant were used as the seed (**Table 6**).

Table 6. Characterization of Granular Seed Taken From Amasya Özmaya Yeast Factory

Parameters	Granules from Amasya Özmaya Yeast Factory
tCOD (mg/l)	27106 ± 152
TS (mg/l)	34310 ± 232
VS (mg/l)	29850 ± 132
VS/TS (%)	87
TKN (mg/l)	896 ± 21
TP (mg/l)	482 ± 36

The same basal medium (**Table 5**) was used from the start up in second set of reactors but only in one of the reactors. The UASB 3 reactor was ran without BM except alkalinity addition. The reason for operating the UASB 3 reactor was examining the effects of the BM in anaerobic treatability of pistachio waste. As experienced from the first set of UASB reactors, alkalinity addition was needed to stabilize pH, therefore only alkalinity addition was applied. For alkalinity addition sodium bicarbonate was used. The UASB 4 was operated with BM. All the other parameters (influent COD, HRT, OLR, pH, Temperature) were the same for UASB 3 and UASB 4.

After the first set, it was decided to increase the HRT for increasing the treatment efficiency and biogas yield. In second set, the UASB reactors were operated with the HRT of 5.4 days. The reactors were fed with diluted pistachio wastewater as in the first set. The dilution ratio was arranged to set the OLR to 1 g/l/d. The OLR increased regularly with the acclimation of the granules (Section 4.2 & 4.3; **Figure 17**, **Figure 18**, **Figure 19**, **Figure 20**). COD removal efficiency was considered as an indicator of steady state phase. When the deviation in the COD treatment efficiency became less than 10 % for 3 - 5 measurements it was accepted as steady state. When reactors reached the steady state, OLR was increased.

In second series pH of the reactors ranged between 7.8 & 8.2.

The wastewater was taken again from TADIM Gaziantep Pistachio Processing Factory. But for the second experimental setup, the wastewater was received in two different batches. Sufficient the wastewater was kept in – 20 °C deep freeze refrigerator until used.

The operation parameters such as effective volume of reactors, times of operation, HRT of the reactors and BM usage for reactors in both setups are given in **Table 7**.

Table 7. Operational Parameters

Reactor Name	Operational Parameters			
	Effective Volume (ml)	Operated Days	HRT (days)	BM Addition
UASB 1	700	180	4	BM Addition (days 60 – 177)
UASB 2	700	150	4	BM Addition (days 0 – 149)
UASB 3	2000	145	5.4	Only Alkalinity Addition (days 0 - 143)
UASB 4	2000	145	5.4	BM Addition (days 0 – 143)

3.3 Experimental Analyses

Reactors were fed continuously. In every two days, the substrate was prepared for feeding. In this preparation, the wastewater’s COD measurement was done and diluted with distilled water. The dilution rate was arranged according to the experimental configuration. In both of the experimental setups, COD analyses of influent and effluent were done once in two days. All the analyses were done with duplicates and the average values were used to draw the graphs.

Gas measurements were done once every two days. Initially, the biogas produced was directly collected in the water displacement device. But after experiencing some technical inadequacies, the produced biogas was collected in 10 L tedlar bags. The volume of the gas produced was measured in water displacement device (**Figure 16**). Biogas

composition was periodically determined with a gas chromatograph (Thermo Electron Co.) equipped with a thermal conductivity detector (TCD). Produced biogas was separated as H₂, CO₂, O₂, CH₄ and N₂ by using serially connected columns (CP-Moliseve 5A and CP- Porabond Q) at a fixed oven temperature of 45 °C. Helium was used as carrier gas at 100 kPa constant pressure. The inlet and detector temperatures were set to 50 °C and 80 °C, respectively.



Figure 16. Water Displacement Device

CHAPTER 4

RESULTS AND DISCUSSION

In this chapter, the characterization of the pistachio processing wastewater used and the experimental results obtained from the UASB reactors operated are presented.

4.1. Characterization of Pistachio Processing Wastewater

The results of the characterization of pistachio processing wastewater is given in Table 8. Based on the COD values, this wastewater could be considered as a high strength wastewater. Thus, it is not feasible to treat this wastewater with conventional activated sludge process.

C/N/P ratio is 1000/1.06/4.26. It is observed that TKN of the pistachio wastewater is below the desired values but this can be overcome by BM addition. Phosphorus concentration is in agreement with desired C/N/P ratio for optimum anaerobic treatment. The influent total solids concentration should be less than 10000-15000 mg/l for a UASB reactor. Thus, it has to be filtered before feeding the UASB to prevent clogging.

Table 8. Pistachio Process Wastewater Characteristics (Demirer, 2016)

Parameter	Pistachio Process Wastewater
Total Chemical Oxygen Demand (tCOD)	41400 mg/l
Soluble Chemical Oxygen Demand (sCOD)	27000 mg/l
Total Kjehldal Nitrogen (TKN)	28.47 mg/l
Total Phosphorus (TP)	115.0 mg/l
Total Solids (TS)	27953 mg/l
Volatile Solids (VS)	16653 mg/l
Total Suspended Solids (TSS)	15575 mg/l
Volatile Suspended Solids (VSS)	14800 mg/l

In the harvesting season fresh pistachio processing wastewater was taken from Gaziantep Tadım Pistachio Processing Factory. After the fresh pistachio processing wastewater were taken, it was used in the reactors. In the section 4.2 and 4.3, the reasons and the time of the fresh pistachio processing wastewater usage was explained. The fresh pistachio processing wastewater characteristics were given in the Table 9.

Table 9. Fresh Pistachio Processing WW Characteristics

Parameter	Fresh Pistachio Processing WW
Total Chemical Oxygen Demand (tCOD)	49800 mg/l
Soluble Chemical Oxygen Demand (sCOD)	35362 mg/l
Total Kjehldal Nitrogen (TKN)	27.95 mg/l
Total Solids (TS)	26521 mg/l
Volatile Solids (VS)	17016 mg/l

4.2. First Setup

In first setup, two 700 ml UASB reactors were used. UASB 1 and UASB 2 were replicates. They both had the same operation conditions and therefore had the same problems. At first, both reactors had a pH drop caused by lack of alkalinity which is explained in part 4.2.1.

As can be followed from the **Figure 17 & Figure 18**, beyond the period of low pH values (days 50 - 70 for UASB 1 & 10 – 40 for UASB 2), the COD removal efficiency of the UASB 1 and UASB 2 increased to 73.8 and 90%., respectively (**Figure 17, b & Figure 18, b**).

In both UASB 1 and UASB 2 reactors (**Figure 17, b & Figure 18, b**), there were some decrease in COD removal efficiency between the days 70 – 100 for the first reactor and between the days 30 – 60 for second reactor. During these periods, the COD removal efficiencies were 63.45 ± 7.42 and 71.18 ± 5.92 for UASB 1 and UASB 2, respectively. Feeding was immediately stopped and a series of tests were done to find the origin of the problem. UASB 1 and UASB 2 reactors were not operated for 5 days. The gaps in the Figure 17 and Figure 18 were reasoned from this situation. The parameters alkalinity, TAN, TKN and Nitrate analyses were made to find the problem. The origin of the nitrate was found as the distilled water used for dilution of the wastewater for OLR adjusting purposes. Technical problems in the water distillation unit caused the increase of nitrate in the distilled water to 40 ± 2.3 mg/l. As the performance of the reactors increase after the nitrate inhibition stopped, it was decided that the nitrate inhibition was the factor causing the drop in COD removal and biogas production performance. After the problem found and solved, the COD removal efficiencies of both reactors were increased (**Figure 17, b & Figure 18, b**).

In both reactors, biogas production was observed. At first, the system was directly connected to water displacement device but some problems were encountered. Because of the pressure difference between water displacement device and water source of the system, water level was not stable in the UASB. Thus, the measurement system was

changed and 10 L tedlar bags were used to collect the produced biogas. Then, the biogas collected in tedlar bags was transferred to the water displacement device to determine the volume of the produced biogas.

The highest methane yield observed was 262 ml CH₄/ g COD_{reduced} in UASB 1 reactor and 363 ml CH₄ / g COD_{reduced} in UASB 2 reactor. For the UASB 1, the maximum methane yield was observed between the days 108 – 119 with the OLR increase from 1.2 – 1.5 g/L/d to 2.9 – 3.3 g/L/d (**Figure 17, f**). But after days 135 - 140, COD removal efficiency of the UASB 1 reactor dropped. Thus, the OLR was decreased to 1.5 g/L/d to prevent overloading and acidification of the reactor. After the COD removal performance increased to % 80 (**Figure 18, b**), the OLR was increased to 3.5 – 4.5 g/l/d but the maximum methane yield of 262 ml CH₄/ g COD reduced could not be reached again. After the first reactors performance recovered, the COD removal efficiency was stabilized around 80 % (**Figure 18, b**). The maximum COD removal efficiencies observed in the UASB 1 and the UASB 2 reactor were % 88.9 and % 91.3, respectively.

The summary of the operational parameters and performance of the first setup is provided in Table 10.

Table 10. Results of UASB1 & UASB2

		Stage 1	Stage 2	Stage 3	Stage 4
UASB 1	Days	0 - 108	108 - 127	127 - 145	145 - 177
	Influent COD (mg/l)	5503.22 ± 1087.62	11613.57 ± 1097.91	7543.03 ± 71.04	19971.05 ± 3583.11
	Ave. OLR (g/l/d)	1.375 ± 0.275	2.88 ± 0.33	1.89 ± 0.02	4.99 ± 0.94
	Ave. COD Removal Efficiency (%)	70.8 ± 9.9	78.51 ± 4.25	75.27 ± 2.12	83.65 ± 4.55
	Ave. Methane Yield (ml/g)	131.00 ± 7.86	178.48 ± 5.35	187.70 ± 1.21	140.20 ± 1.26
UASB 2	Days	0 - 76	76 - 96	96 - 114	114 - 149
	Influent COD (mg/l)	4476.45 ± 926.31	11528.57 ± 1239.99	7543.03 ± 71.04	19754.09 ± 3494.14
	OLR (g/l/d)	1.07 ± 0.479	3.21 ± 0.80	1.81 ± 0.08	6.05 ± 1.27
	Ave. COD removal Efficiency %	70.82 ± 6.93	82.35 ± 3.32	77.80 ± 1.54	86.18 ± 5.61
	Ave. Methane Yield (ml/g)	110.92 ± 5.24	205.42 ± 9.09	146.60 ± 4.98	165.37 ± 3.21

4.2.1. UASB 1

During first 30 days (average Inf COD = 6084.14 ± 1292.12 , average OLR = 1.47 ± 0.28), COD removal efficiency increased from 50% to 82% in UASB 1. However, the COD removal efficiency started to decrease afterwards and a dramatic pH drop to 5.5 was observed after day 60. BM addition was started on the day 60 to solve this problem. The pH was increased to 7.5 in the UASB 1 reactor by adding BM but the COD removal efficiency remained to be around 55%. Between days 60 and 85, the reactor was

recovered and the COD removal efficiency increased to 76% between days 85 and 90 as seen in **Figure 17, b**.

The methane percentage of the produced biogas ranged from 31.86 % – 79.47 % with the average value of 53.09 ± 14.96 %. In the UASB 1 reactor average methane yield was around 154 ml CH₄/ g COD_{reduced}. The maximum methane yield observed was 262 ml CH₄/ g COD_{reduced}. (**Figure 17, e**)

As seen from Table 10, UASB reactors were operated under 4 different OLR's. The discussion of the results are presented based on four stages (namely Stage 1, Stage 2, Stage 3 and Stage 4 at days 0 – 108, 108 – 127, 127 – 145, and 145 – 177 respectively) which correspond to these OLR levels.

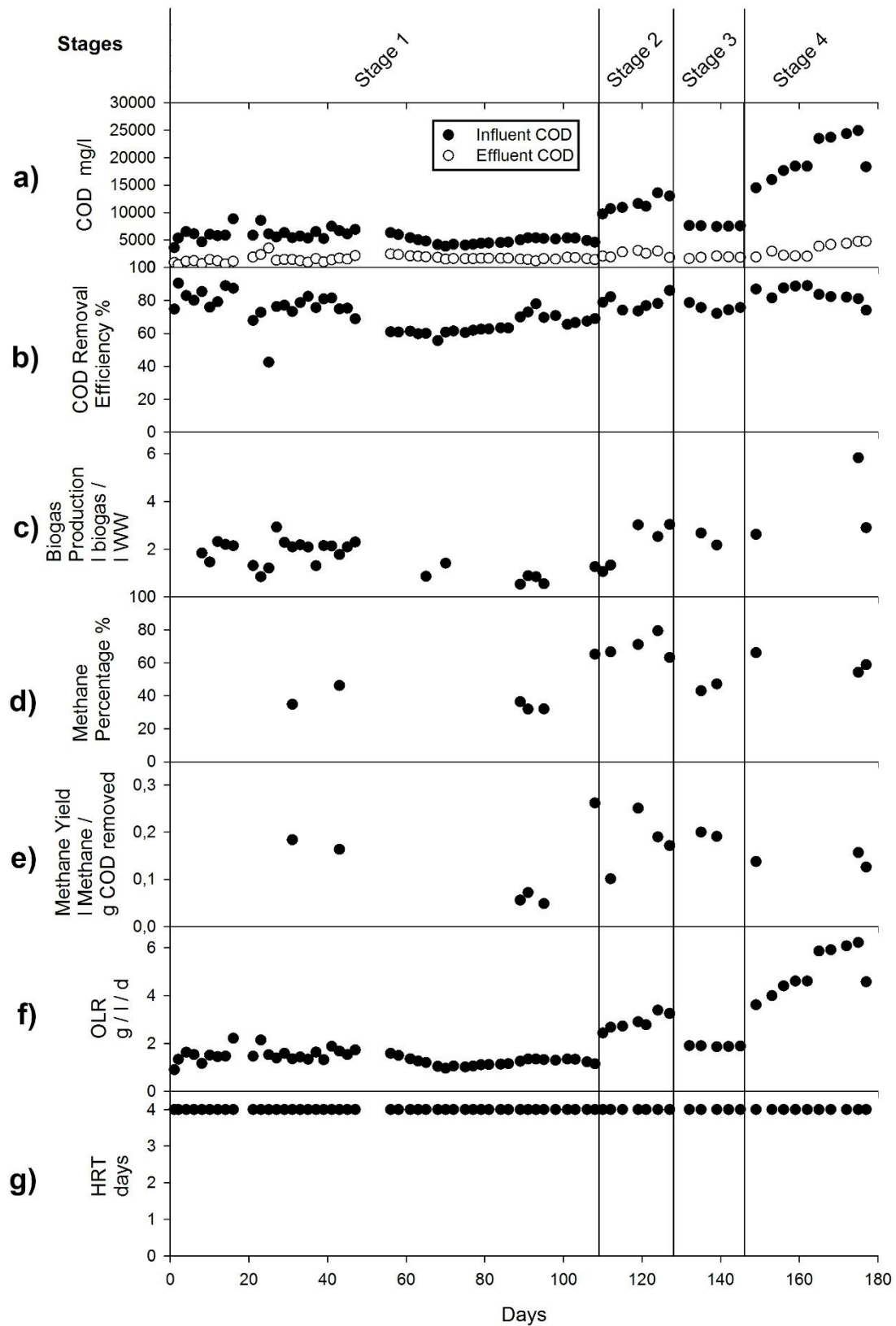

Figure 17. UASB 1 a) Influent & Effluent COD, b) COD Removal Efficiency, c) Biogas Production , d) Methane Percentage , e) Methane Yield , f) OLR and g) HRT

4.2.1.1. Stage 1

The first stage of the UASB 1 reactor was 108 days. Initially, the OLR was adjusted to 1 – 1.5 g/l/d. The average OLR value was 1.375 ± 0.275 g/l/d.

Initially, the wastewater was diluted with distilled water with a ratio of 1/8. It was planned to operate the reactor in the same conditions until it reached to steady state conditions and then the OLR would be increased gradually. The expected period was around 30 - 40 days for stage 1. But there was a very high fluctuation in the COD removal efficiency and the biogas yield. Therefore, Stage 1 was extended way beyond 30-40 days. After 20 days of operation, the COD removal efficiency started to decrease and after 30 days, a pH dramatic drop was observed. As a response, BM addition was started. After the pH problem was handled, UASB 1 was recovered in two weeks. But another inhibition was observed after day 47 (**Figure 17 , b**). Biogas production stopped and the COD removal efficiency dropped from 78% to 60 %. After a series of tests the problem was determined. Nitrate concentration of the dilution water was measured to be 40 ± 2.3 mg/l which was due to problem in the water distillation equipment. To solve this problem, the dilution water was replaced with ultra-pure water. This change resulted in the recovery of the performance of the reactor in around 30 days and the UASB 1 reached back to steady state conditions.

In Stage 1, the average COD removal efficiency was 70.8 ± 9.9 %. The average COD removal efficiency before the nitrate inhibition was 77.4 ± 9.6 %. It was reduced to 63.45 ± 7.42 due to nitrate problem. Banihani (2009) reported that 8.3 – 121 mg/l $\text{NO}_3\text{-N}$ may cause nitrate inhibition and negative effects on anaerobic processes (Banihani et al., 2009). $\text{NO}_3\text{-N}$ of the dilution water was measured as 40 mg/l and the recovery of the reactor after changing the dilution water source is in agreement with the literature about nitrate inhibition.

4.2.1.2. Stage2

The second stage of the operation of UASB 1 reactor was lasted between the days 108 and 127. The OLR was adjusted to 2.43 – 3.25 g/l/d by increasing the influent COD. Since the HRT of the system was constant, OLR was directly proportional to influent COD. The OLR was increased gradually from 2.43 to 3.25 g/l/d (**Figure 17, b**). The average OLR was 2.88 ± 0.33 g/l/d. COD removal efficiency in Stage 2 was higher than Stage 1. The increase in the OLR affected the performance of the system and the average COD removal efficiency was observed as 78.51 ± 4.25 %.

4.2.1.3. Stage 3

The third stage of the operation of UASB 1 reactor lasted between the days 127 and 145. The average OLR was 1.89 ± 0.02 g/l/d. The significant decrease in OLR was due to the stalling of the remaining pistachio wastewater used. As mentioned in literature review part (Section 2.1.3.1), pistachio harvested in September and stored. The pairing process is done throughout the year. The fresh pistachio processing wastewater was collected and used in and beyond Stage 3 (**Table 9**). Due to the use a different batch of wastewater, the OLR was decreased to 1.9 g/l/d for acclimation of the reactor. The reactor stabilized around two weeks and then the OLR was increased again.

4.2.1.4. Stage 4

In the fourth Stage which was between days 145 to 177, the OLR was kept between 3.62 and 6.22 g/l/d. Average OLR in Stage 4 was 4.99 ± 0.94 g/l/d. Since the granules were acclimated to the feed in the earlier stages, OLR was increased sharply (**Figure 17, f**). The maximum influent COD is given to the reactor at the day 168 and was around 23690 mg/L. Average COD removal efficiency in Stage 4 was 83.65 ± 4.55 % and the maximum COD removal efficiency was observed as 88.96 % at the day 162.

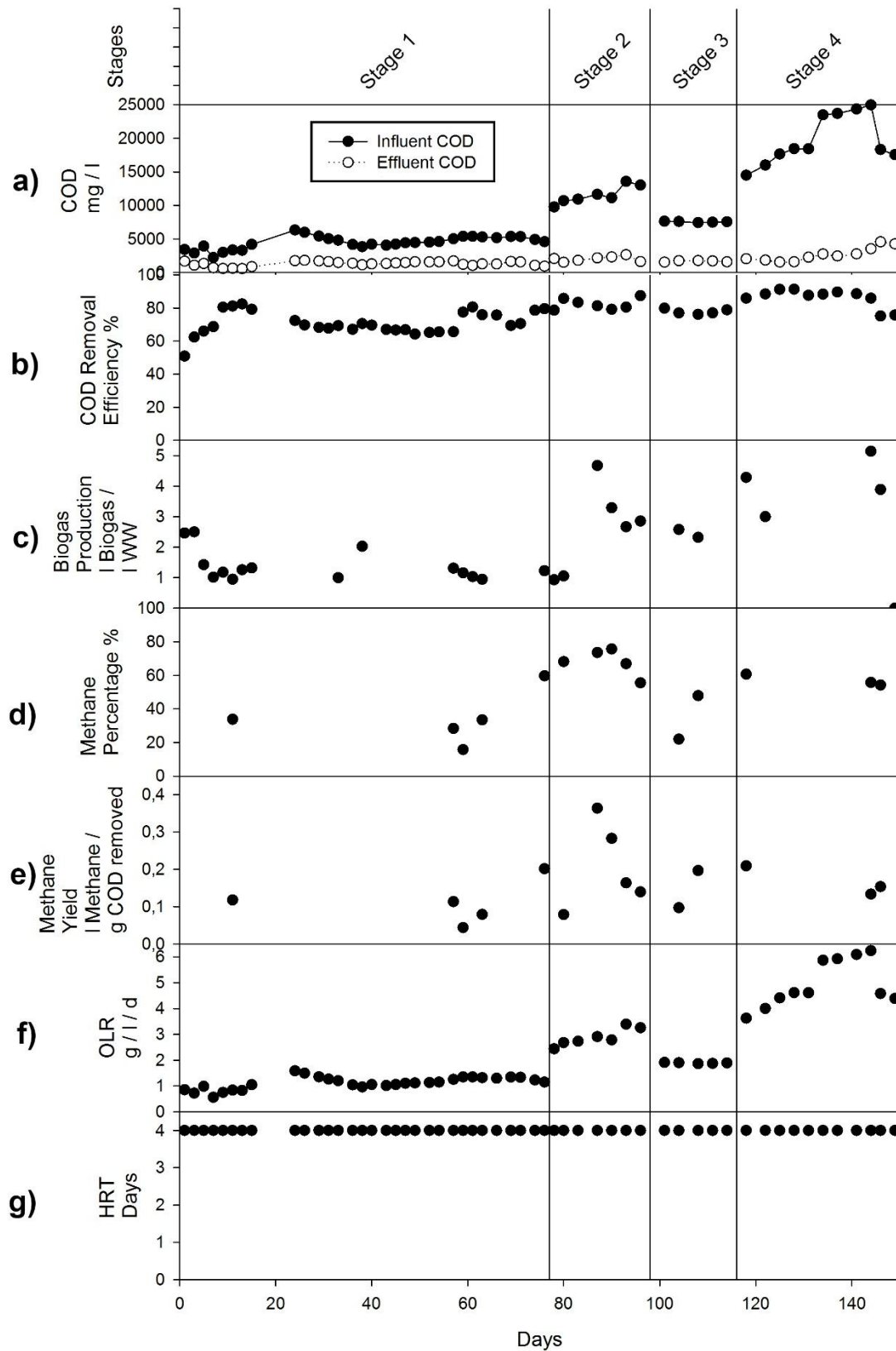

Figure 18. UASB 2 a) Influent & Effluent COD, b) COD Removal Efficiency, c) Biogas Production , d) Methane Percentage , e) Methane Yield , f) OLR and g) HRT

4.2.2. UASB 2

The UASB 2 collapsed due to pH drop caused by the lack of alkalinity. After this incident, the UASB 2 cleaned and started up again but with BM from the first day. The results presented for UASB 2 are given in Figure 18, included the period beyond the second start-up. Differences in operation period between the UASB 1 and UASB 2 reactors were due to this situation.

The initial influent COD concentration was around 3500 mg/l and increased gradually to around 25000 mg/ as seen in Figure 18, a.

The effluent COD concentration was always below 5000 mg/L (**Figure 18, a**). The COD concentration level for discharging to the sewer system is defined as 1000 mg/L with the agreements between the Municipality and the pistachio industries in Gaziantep. Therefore, a polishing treatment step is further needed for discharge of the wastewater after the UASB reactor.

The methane percentage of the produced biogas ranged from 15.71 % – 75.7 % with the average value of $50.09 \pm 18.44\%$. In UASB 2 reactor average methane yield was around 200 ml CH₄/ g COD reduced, and the maximum methane yield was 363 ml CH₄/ g COD_{reduced} (**Figure 18, e**)

4.2.2.1. Stage 1

The first stage of the UASB 2 reactor was operated between days 0 to 76. The OLR was adjusted to 1 – 1.5 g/l/d. Average OLR value was 1.07 ± 0.479 g/l/d. The expected operation time in Stage 1 was not as long as 76 days in UASB 2 reactor. Similar to UASB 1, some mechanical problems were encountered.

The performance of the reactor in terms of COD removal and biogas production went down around day 26 as seen in Figure 18, b & c. Similar to UASB 1, the reason was determined to be the nitrate inhibition. After the source of the dilution water was replaced,

the reactor was recovered faster than the UASB 1 reactor as seen in Figure 17 & Figure 18. UASB 2 reactor was operated with BM supplementation from the beginning which was the only difference from the UASB 1. The reactor with the BM recovered after nitrate inhibition rapidly when compared to UASB 1. After recovery period it took around 30 days to reactor reach to the steady state (**Figure 18**).

In this stage of operation, the average COD removal efficiency was 70.82 ± 6.93 %. COD removal efficiency was more stable compared to the UASB 1 reactor which can be attributed to nutrient (BM) supplementation.

There is no study to compare the performance obtained in this study. However, the performance of the c.

4.2.2.2. Stage 2

The second stage of the operation of UASB 2 reactor was lasted between the days 76 and 96. The OLR was set to 2 – 4 g/l/d by increasing the influent COD. Since the HRT of the system was constant, OLR was directly proportional to influent COD. The average OLR value was 3.21 ± 0.80 g/l/d. COD removal efficiency in Stage 2 was higher than the first stage. The increase in the OLR affected the treatment efficiency positively. The average COD removal efficiency was 82.35 ± 3.32 %. Treatment efficiency of the UASB 2 was higher than the UASB 1 for similar OLR values.

4.2.2.3. Stage 3

The second stage of the operation of UASB 2 reactor was lasted between the days 96 and 114. The average OLR was 1.81 ± 0.08 g/l/d. The significant decrease in OLR was resulted from the composition of the wastewater as already explained for UASB 1 in Section 4.2.1.3. (Stage 3 of UASB 1). As the UASB 1 reactor, the wastewater was replaced and OLR adjusted to a lower level for acclimation. After the Stage 3, the fresh pistachio processing wastewater was used. The reactor stabilized around two weeks and

then the OLR was increased again to 4.78 g/l/d (**Figure 18, f**). Average COD removal efficiency was determined as 77.80 ± 1.54 % in Stage 3.

4.2.2.4. Stage 4

In the fourth stage which lasted between the days 114 to 149, the OLR increased from 4.78 to 7.55 g/l/d. Average OLR in the stage was 6.05 ± 1.27 g/l/d. Since the granules acclimated well the OLR increasing done sharply. The maximum influent COD is given to the reactor at the day 168 and was around 24960 mg/L. Average COD removal efficiency in this stage was 86.18 ± 5.61 % and the maximum COD removal efficiency was observed as 91.37 % on day 128.

4.3. Second Setup

As seen from Table 11, UASB reactors were operated under 4 different OLR levels as it was in first setup. The discussion of the results are presented based four stages (namely Stage 1, Stage 2, Stage 3 and Stage 4 at days 0 – 29, 29 – 66, 66 – 108, and 108 – 143) which correspond to these OLR levels. The UASB 3 and 4 were operated in the absence and presence of BM in the feed, respectively. The obtained experimental results for the second setup reactors (UASB 3 & UASB 4) are provided in this section.

Table 11. Results of UASB3 & UASB4

		Stage1	Stage 2	Stage 3	Stage 4
UASB 3	Days	0 - 29	29 - 66	66 - 108	108 - 143
	Influent COD (mg/l)	7409.00 ±1091.22	15010.28 ±2251.66	21553.81 ±3742.06	24650.00 ±2339.20
	Ave. OLR (g/l/d)	1.37 ± 0.2	2.78 ± 0.42	3.899 ± 0.698	4.56 ± 0.87
	Ave. COD Removal Efficiency (%)	85.24 ± 6.48	87.49 ± 4.98	85.47 ± 5.5	89.77 ± 2.47
	Ave. Methane Yield (ml/g)	272.98 ± 58.89	326.64 ± 71.46	300.05 ± 63.40	332.56 ± 104.55
UASB 4	Days	0 - 29	29 - 66	66 - 108	108 - 143
	Influent COD (mg/l)	7719.67 ±1594.42	15953.89 ±2789.17	21170.24 ±5149.97	26010.00 ±5517.21
	OLR (g/l/d)	1.43 ± 0.29	2.90 ± 0.41	4.86 ± 1.18	5.98 ± 1.27
	Ave. COD removal Efficiency %	77.38 ± 6.048	82.23 ± 6.43	71.51 ± 9.36	70.72 ± 6.61
	Ave. Methane Yield (ml/g)	268.62 ± 75.41	287.398 ± 74.09	300.05 ± 63.40	280.32 ± 103.81

4.3.1. UASB 3

The initial influent COD concentration was 5000 mg/L in UASB 3 and increased gradually to 30000 mg/L (**Figure 19**). The effluent COD values are ranged from 395 – 4000 mg/L (**Figure 19**). When the influent COD concentration was increased, a slight decrease in the COD removal efficiency was observed (**Figure 19**), but it was recovered in a few days.

OLR was started from low levels and gradually increased to test the treatability and observe the adaptation trend in the reactor. OLR of the reactor is ranged from 0.8 – 5.8 g/L/d. The HRT of the system was adjusted to 5.4 days.

The COD removal efficiency of the UASB 3 reactor ranged between 74.53 % – 95.84 % and the average COD removal efficiency was 86.74 ± 5.69 %.

The methane percentage of the produced biogas ranged from 47.16 % – 72.01 % with the average value of 64.84 ± 5.03 %.

The average methane yield was 305.49 ± 87.23 ml CH₄/g COD reduced.

The maximum COD removal efficiencies, above 95 %, were observed in different OLR values as 3.91 g/L/d., 4.01 g/L/d and 4.87 g/L/d.

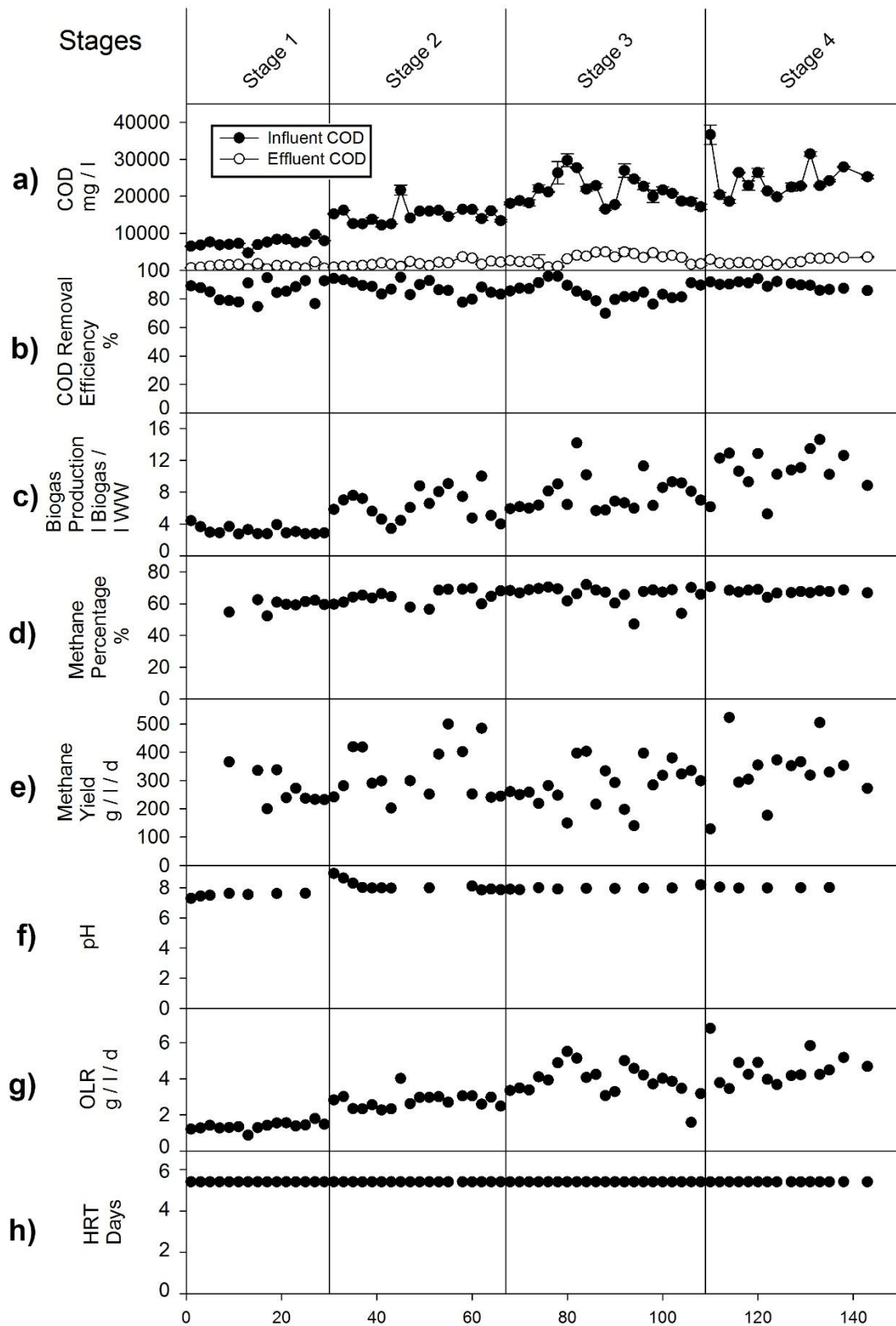

Figure 19. UASB 3 a) Influent & Effluent COD, b) COD Removal Efficiency, c) Biogas Production, d) Methane Percentage, e) Methane Yield, f) pH, g) OLR and h) HRT

4.3.1.1. Stage 1

The Stage 1 of UASB 3 lasted until day 29. The OLR was adjusted to 1 - 1.5 g/l/d. Average OLR value was 1.37 ± 0.2 g/l/d. The HRT of the reactor was kept constant at 5.4 days. The effluent pH value was 7.53 in average.

The wastewater of pistachio processing factory was diluted in the ratio of $\frac{1}{4}$ with ultra-pure water initially and then the COD concentration was gradually increased. The average influent and effluent COD were 7409 ± 1091 and 1106.33 ± 543.7 mg/L, respectively.

In this stage of operation, the average COD removal efficiency was 85.24 ± 6.48 % (**Figure 19, b**). COD removal efficiency was more stable than the first series of reactors (UASB 1 and 2 (**Figure 17** & **Figure 18**)).

Biogas production was calculated as 3.17 L biogas / L wastewater in average. Average methane percentage was 59.098 ± 3.45 % in this stage. Methane yield was determined as 272.98 ± 58.89 ml CH₄/ g COD_{reduced} (~ 442.26 ml CH₄/ g VS) in average in Stage 1.

Katsoni et al. (2014) used an UASB reactor for the treatment of diluted olive pomace leachate and reported maximum COD treatment efficiency as %70. The OLR and HRT used in this study were 0.33-1.67 g/l/d and 3 d, respectively which were similar to the values used in this study. Moreover, Fang et al. (2011) used raw palm oil mill effluent as carbon source within UASB reactor configuration which was operated 5 days of HRT. In this study methane yield was reported as 436 ml CH₄/ g VS. The COD removal efficiency and average methane yield (442.26 ml CH₄/ g VS) determined for the UASB 3 were comparable to these studies that also conducted for high strength agro-industrial wastewaters.

4.3.1.2. Stage 2

The second stage of the operation of UASB 3 reactor was lasted between the days 29 and 66. The OLR was adjusted to 2 - 3 g/l/d. Average OLR value was 2.78 ± 0.42 g/l/d. The HRT of the reactor was kept constant at 5.4 days. The average effluent pH was around 8. After pH value increased because of the alkalinity addition dosage, calculated theoretically, overcame the needed dosage, the gas production efficiency was increased. Especially the methane percentage of the gas increased from 59.098 % to 64.21 %. The corresponding methane yield was 326.64 ± 71.46 ml CH₄/ g COD reduced.

Dilution ratio of the wastewater was set as $\frac{1}{2}$ in Stage 2 of UASB 3 operation. The average influent and effluent COD were 15010.28 ± 2251.66 and 1872.22 ± 773.95 mg/L, respectively. This corresponded to average COD removal efficiency of 87.49 ± 4.98 %.

Sabbah et al. (2003) also employed UASB reactors to treat raw and pretreated olive mill wastewater with HRT of 5 days and reported that olive mill wastewater could be treated with COD removal efficiency and biogas yield of 80 - 90 % and 300 l/kg COD_{reduced}, respectively. It was clear that pistachio wastewater treatment efficiencies were higher than these values at comparable operational conditions.

4.3.1.3. Stage 3

The third stage of the operation of UASB 3 reactor was lasted between the days 66 and 108. The OLR was adjusted between 3 – 4.5 g/l/d with an average of 3.899 ± 0.698 g/l/d. The effluent pH of UASB 3 was in the range of 7.88 – 8.2 with an average of 7.98. The HRT of the reactor was 5.4 days.

In Stage 3, UASB 3 was fed with the pistachio wastewater diluted with pure water in the ratio of 3/4. The influent COD was 21553.81 ± 3742.06 mg/l in average. Average effluent COD was 3236.07 ± 1294.44 mg/l. The average COD removal efficiency was 85.47 ± 5.5 %.

Average methane percentage of the produced biogas was 66.84 ± 4.11 %. Biogas production in the Stage 3 was 7.54 ± 2.18 l biogas/ l wastewater. Methane yield in the Stage 3 was 300.05 ± 63.40 ml CH₄/ g COD_{reduced} (486 ml CH₄/ g VS).

Gavala (1999) obtained COD removal efficiency of 79 – 91% lab scale UASB which was used to examine the treatment efficiency of dairy wastewater. The operation parameters were OLR of 2.5 - 4.5 g/l/d and HRT of 10 – 20 days (Gavala et al., 1999). Moreover, Garcia et al. (2008) operated a UASB reactor with OLR of 5 g/l/d and influent COD concentration of 16512 – 20434 mg/l to treat the liquid fraction of dairy manure. They reported a COD removal efficiency of 87.1 % and methane yield of 362 ml CH₄/ g COD (García et al., 2008). Anaerobic COD removal efficiency of pistachio processing wastewater by UASB (85.5 %) was comparable with both of the studies above but methane yield was slightly lower (300.05 ± 63.40 ml CH₄ / g COD_{reduced}) than those reported by Garcia et al. (2008) study.

4.3.1.4. Stage 4

The operation of UASB 3 between days 108 and 143 was named as Stage 4. The OLR was adjusted to the range between 4 – 6 g/l/d. Average OLR was 4.56 ± 0.87 g/l/d. The pH was kept constant in the range of 7.98 – 8.05 and the average was 8.01 (**Figure 19, f**). The HRT of the reactor was 5.4 days as in other UASB reactors.

In Stage 4, UASB 3 was fed directly with pistachio processing wastewater. The BM was added in concentrated form. The influent COD was 24650 ± 2339.20 mg/l in average. Average effluent COD was 2511.33 ± 717.68 mg/l. COD removal efficiency of the third stage was 89.77 ± 2.47 % in average (**Figure 19, b**)

Average methane percentage of the produced biogas was 67.64 ± 1.52 %. Biogas production in this stage was 10.74 ± 2.59 l biogas/ l wastewater. Methane yield in the third stage was 332.56 ± 104.55 ml CH₄/ g COD reduced (**Figure 19, d & e**).

Gavala et al. (1999) reported that in a UASB with OLR and HRT of 6.2 g/l/d and 6 days, respectively, the observed treatment efficiency was between 85 -90 % of dairy wastewater . In another study, Kalyuzhnyi et al. (1996) reported that the COD treatment efficiency was close to 95% in a UASB reactor which was employed to treat cheese whey wastewater with an OLR of 6.5 g/l/d. The COD removal efficiency obtained in the Stage 4 of the operation of UASB 3 reactor was comparable with both of these studies which were focused on well-known wastes in literature.

4.3.2. UASB 4

The UASB 4 was operated in the presence of BM. COD influent of UASB 4 was started from around 4500 mg/l and increased gradually to 30000 mg/l. The corresponding effluent COD values ranged from 502 – 8890 mg/l. In higher COD values, the adaptation period of the fourth reactor was shorter than the third one; however, the overall efficiency of the third reactor was higher.

OLR of the reactor ranged from 0.81 – 7.78 g/l/d. Initially the OLR was adjusted to around 1 g/l/d and gradually increased to 8 g/l/d. Similarly, the HRT of the system was fixed to 5.4 days in fourth reactor, therefore the OLR increase was directly connected to COD increase.

The COD removal efficiency of UASB 4 ranged between 50.36 % – 94.90 % and the average COD removal efficiency was 75.33 ± 8.92 . This value was lower than that of the UASB 3.

The methane percentage of the biogas produced in the UASB 4 ranged from 52.23 % - 72.01 % and the average was 64.89 ± 4.92 . The methane yield was calculated as 290.50 ± 28.49 ml CH₄/g COD reduced.

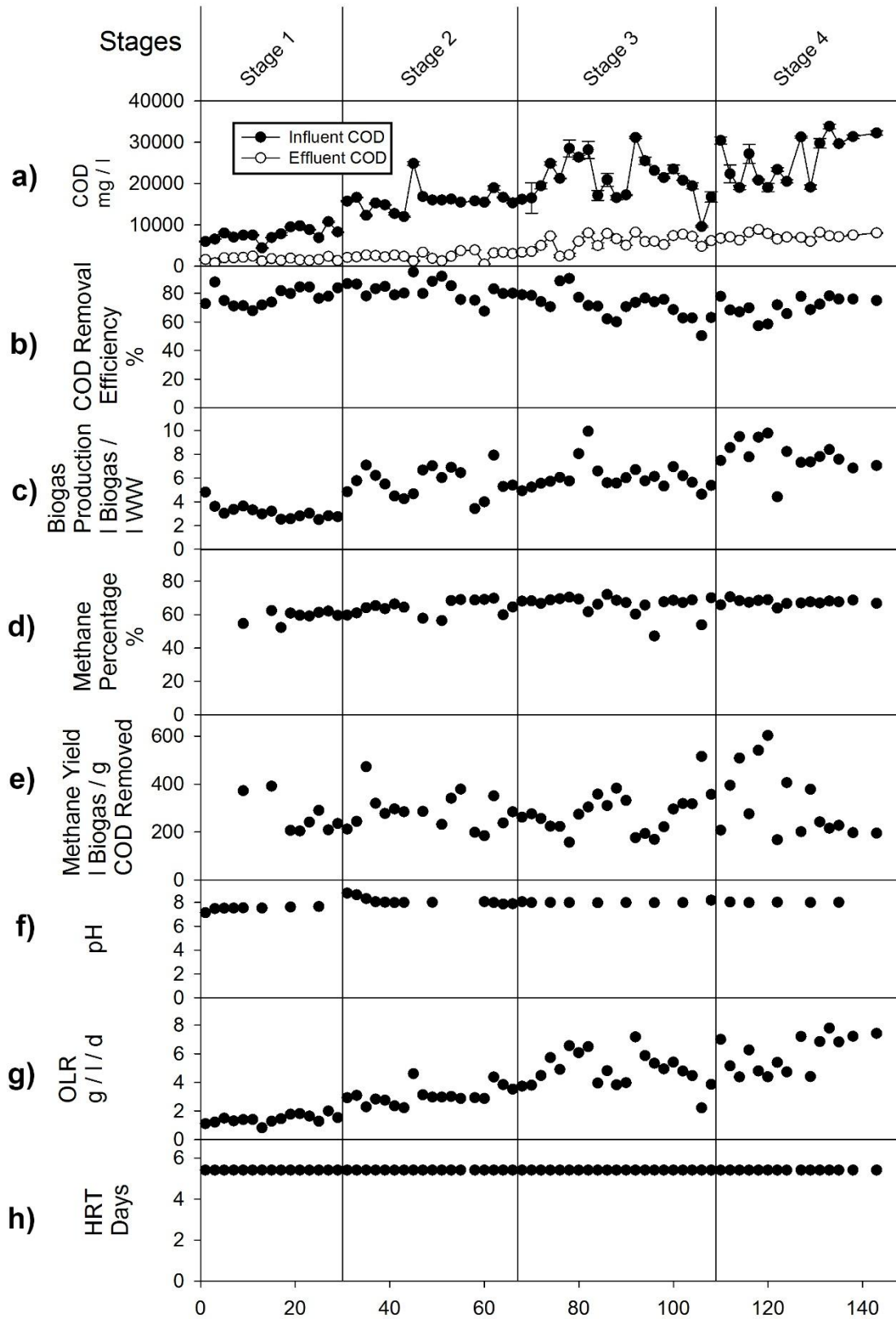

Figure 20. UASB 4 a) Influent & Effluent COD, b) COD Removal Efficiency, c) Biogas Production, d) Methane Percentage, e) Methane Yield, f) pH, g) OLR and h) HRT

4.3.2.1. Stage 1

The first stage of the UASB 4 operation was continued until day 29. The OLR was adjusted to 1 – 1.5 g/l/d. Average OLR value was 1.43 ± 0.29 g/l/d. The HRT of the reactor was kept constant at 5.4 days. The pH value was 7.49 in average. (**Figure 20, f & h**)

The wastewater of pistachio processing factory diluted in the ratio of $\frac{1}{4}$ with ultra-pure water. Average influent COD was 7719.67 ± 1594.42 mg/l. Effluent COD was 1708 ± 447.88 mg/l in average (**Figure 20, a**).

In this stage the average COD removal efficiency was 77.38 ± 6.048 % (**Figure 20, b**). COD removal efficiency was more stable than the first series of reactors but the treatment efficiency was lower than the UASB 3.

Biogas production was calculated as 3.13 ± 0.59 l biogas / l wastewater in average. Average methane percentage was 59.098 ± 3.45 in this stage. Methane yield determined as 268.62 ± 75.41 ml CH_4 / g $\text{COD}_{\text{reduced}}$ in average in the first stage. (**Figure 20, c, d & e**)

4.3.2.2. Stage 2

The second stage of the operation of UASB 4 reactor was lasted between the days 29 and 66. The OLR was adjusted to 2 - 3 g/l/d. Average OLR value was 2.90 ± 0.41 g/l/d. The HRT of the reactor was hold in 5.4 days. The pH value was 8.13 in average.

Dilution ratio of the wastewater was $\frac{1}{2}$ in the second stage. Average influent COD was 15953.89 ± 2789.17 mg/l. Similar to UASB 3 there was a slight fluctuation in the influent COD. Effluent COD was 2495.69 ± 898.24 mg/l in average.

In this operational stage, the average COD removal efficiency was 82.23 ± 6.43 %. COD removal efficiency was also upgraded with the increasing pH and OLR (**Figure 20**). The

reason of pH increasing was the alkalinity addition to the wastewater. The alkalinity dosage was calculated theoretically but after the pH increase, the alkalinity addition dosage recalculated and regulated. After the recalculation pH were keep constant.

Methane percentage of the gas increased from 59.098 % to 64.21 %. In connection with, biogas production also developed from 3.13 l CH₄/l WW to 5.66 l CH₄/l WW and the methane yield was upgraded to 287.398 ± 74.09 ml CH₄/ g COD_{reduced} (~464.94 ml CH₄/ g VS) (**Figure 20, e**)

In literature, Fang et al. (2011) observed that the methane yield was 240 ml/ g vs added in a UASB reactor which was operated at an OLR range of 2.5 – 3.2 g COD/l/d and HRT of 8 days treating potato juice. Methane yield was clearly superior in pistachio wastewater treatment experiments than potato juice treatment. Parawira et al. (2004) also used an UASB reactor for potato waste leachate which had operation conditions as OLR between (1.5 – 7 g/l/d.) and HRT between (2.9 – 13.2 days). COD removal efficiency was 95.3 and methane yield was 110 ml CH₄/ g COD reduced when OLR was 3 g/l/d. Although the COD removal efficiency of pistachio wastewater slightly lower than this study, the methane production potential was clearly higher.

4.3.2.3. Stage 3

The operation between the days 66 and 108 were named as Stage 3. The OLR was adjusted to the range between 3 – 5 g/l/d. Average OLR was 4.86 ± 1.18 g/l/d.

The influent COD was 21170.24 ± 5149.97 mg/l in average. Average effluent COD was 5769 ± 1761.16 mg/L. COD removal efficiency of the third stage was 71.51 ± 9.36 % in average.

pH was stable in the range of 7.88 – 8.2 and the average was 7.98. The HRT of the reactor was again 5.4 days.

Average methane percentage of the produced biogas was 66.84 ± 4.11 %. Biogas production in the stage was 7.54 ± 2.18 l biogas/ l wastewater. Methane yield in the third stage was 300.05 ± 63.40 ml CH₄/ g COD_{reduced}. (**Figure 20, c, d & e**)

4.3.2.4. Stage 4

The operation between the days 108 and 143 were named as stage 4. The OLR was adjusted to the range between 4.3 – 7.78 g/l/d. Average OLR was 5.98 ± 1.27 g/l/d. in the fourth stage. pH was hold stable in the range of 7.98 – 8.05 and the average was 8. The HRT of the reactor was again 5.4 days.

In this stage of operation, UASB 4 was fed with directly pistachio wastewater. The BM was added in concentrated form. The influent COD was 26010 ± 5517 mg/l in average. Average effluent COD was 7325 ± 801 mg/l. The average COD removal efficiency was 70.72 ± 6.61 % in average.

Average methane percentage of the produced biogas was 67.52 ± 1.54 %. Biogas production in the stage was 5.65 ± 2.03 l biogas/ l wastewater. Methane yield in the stage 4 was 280.32 ± 103.81 ml CH₄/ g COD reduced. (**Figure 20**)

4.4. Overall Comparison of All Reactors

This study revealed that pistachio processing wastewater is anaerobically treatable. In all UASB reactors significant percentages of COD removal was achieved. In first setup, many problems were faced and solved. After the problems were solved the COD removal efficiency increased but biogas production performance could not reach the performance of second setup reactors.

The summary of the results of all reactors are given in Table 12.

Table 12. Results Summary of All Reactors

	UASB 1	UASB 2	UASB 3	UASB 4
Average COD Removal Efficiency %	74.4	76.8	86.7	75.3
Maximum COD Removal Efficiency %	88.9	91.3	95.9	94.9
Average Methane Yield (ml CH ₄ / g COD _{reduced})	262	200	306	290
Average Methane Percentage %	53.1	50.1	64.8	64.9

Average COD removal efficiency of UASB 1 was 74.4% and the maximum COD removal efficiency was 88.9. Average methane percent of the biogas produced by UASB 1 was 53.1% and the average methane yield calculated was 262 ml CH₄ / g COD_{reduced}.

The second reactor (UASB 2) had a slightly higher COD removal efficiency than UASB 1. In average, COD removal efficiency of UASB 2 was 76.8%. Although the problems were faced in first setup, the maximum COD removal efficiency of UASB 2 surpassed the 90% level and reached 91.3%. Average methane percentage in the produced biogas was 50.1% in the second reactor. Average methane yield of UASB 2 was 200 ml CH₄ / g COD_{reduced}.

The maximum COD removal efficiency of 95.84% was observed in the UASB 3 reactor at an OLR of 4.87 g/l/d and HRT of 5.4 days (Figure 19). In average 86.7% COD removal was achieved in UASB 3. Average methane percentage of the produced biogas by UASB 3 was 64.8% and the average methane yield was calculated as 306 ml CH₄ / g COD_{reduced}. UASB 3 was the most efficient reactor in terms of COD removal, biogas production and methane yield.

UASB 4 had an average and maximum COD removal efficiency of 75.3% and 94.9%, respectively. The average methane percentage in the biogas was 64.9% and the methane yield was 290 CH₄ / g COD_{reduced}.

It was shown that the anaerobic treatment efficiency could be reached to 90 % in terms of COD removal. Anaerobic treatability of pistachio wastewater with considerably high COD removal efficiency was shown in both of the experimental setups. Even the type of the seed, operation pH and operation HRT were different from each other, in terms of COD removal efficiency, biogas production and methane yield in both setups indicated that pistachio wastewater was anaerobically treatable and had a considerable biogas production potential.

Katsoni and coworkers (2014) used an UASB reactor for the treatment of diluted olive pomace leachate and reported maximum COD treatment efficiency as %70. The OLR and HRT used in this study were 0.33-1.67 g/l/d and 3 d, respectively.

Fang and coworkers (2011) used raw palm oil mill effluent as carbon source within UASB reactor configuration which was operated with a HRT of 5 days. In this study methane yield was reported as 436 ml CH₄/ g VS.

Sabbah and coworkers (2003) also employed UASB reactors to treat raw and pretreated olive mill wastewater with HRT of 5 days and reported that olive mill wastewater could be treated with COD removal efficiency and biogas yield of 80 - 90 % and 300 l/kg COD_{reduced}, respectively.

Gavala (1999) obtained COD removal efficiency of 79 – 91% lab scale UASB which was used to examine the treatment efficiency of dairy wastewater. The operation parameters were OLR of 2.5 - 4.5 g/l/d and HRT of 10 – 20 days (Gavala et al., 1999).

Gavala and coworkers (1999) reported that in a UASB with OLR and HRT of 6.2 g/l/d and 6 days, respectively, the observed COD removal efficiency was between 85 - 90 % of dairy wastewater.

Garcia et al. (2008) operated a UASB reactor with OLR of 5 g/l/d and influent COD concentration of 16512 – 20434 mg/l to treat the liquid fraction of dairy manure. They reported a COD removal efficiency of 87.1 % and methane yield of 362 ml CH₄/ g COD (García et al., 2008).

Kalyuzhnyi and coworkers (1996) reported that the COD treatment efficiency was close to 95% in a UASB reactor which was employed to treat cheese whey wastewater with an OLR of 6.5 g/l/d.

Fang and coworkers (2011) observed that the methane yield was 240 ml/ g vs added in a UASB reactor which was operated at an OLR range of 2.5 – 3.2 g COD/l/d and HRT of 8 days treating potato juice.

Parawira and coworkers (2004) also used an UASB reactor for potato waste leachate which had operation conditions as OLR between (1.5 – 7 g/l/d.) and HRT between (2.9 – 13.2 days). COD removal efficiency was 95.3 and methane yield was 110 ml CH₄/ g COD_{reduced} when OLR was 3 g/l/d.

As this was the first study that was conducted for determining the anaerobic treatability performance and biogas production potential of pistachio processing wastewater with continuous reactors in literature, discussions and comparisons (COD removal and methane yield) were done with different studies, mentioned above in this section, which employed UASB reactors. In these studies UASB reactors were operated with similar conditions (OLR, HRT and Inf COD) with this study and used for treating various wastewaters.

All the reactors' performances are comparable with literature. Especially the most efficient reactor, UASB 3's COD removal performance and biogas production potential are comparable with different kind of strength industrial wastewaters such as olive pomace leachate, palm oil mill effluent, olive mill wastewaters, dairy wastewaters, liquid fraction of dairy manure, cheese whey wastewaters, potato juice and potato processing wastewaters although this was the first and pioneering study.

As a summary, performance of UASB reactors in treating pistachio processing wastewaters have a significant achievement when compared with literature.

CHAPTER 5

CONCLUSION

In this study, anaerobic treatability in UASB reactors and biogas production potential of pistachio processing wastewater were examined. Based on the results of this study, the following conclusions could be made.

- Both anaerobic granular seed cultures taken from Anadolu Efes Beer factory and Amasya Özmaya Yeast Factory could be acclimated and used for the treatment of pistachio processing wastewater efficiently.
- After the acclimation period, the COD treatment percentages were greater than 88 % in all reactors.
- Wastewater of pistachio processing factories could be treated with high rate UASB (Upflow Anaerobic Sludge Blanket) reactors.
- BM addition may be necessary for startup period of reactors but after the startup, only alkalinity addition is adequate for reactors. The reactors that BM was added from the beginning, were observed as more resistant to unexpected negative conditions. The recovery period of UASB 2 from nitrate inhibition was more rapid than the UASB 1's recovery period. After the granules were adapted, it was observed that the UASB 3 was the most efficient reactor, which had only alkalinity addition.

- If the annual pistachio processing wastewater of 520000 m³ is treated with anaerobic methods, 13000 tons COD can be removed and 3.9 million m³ of methane can be produced in Turkey. The energy equivalent of the produced biogas is around 28200 mwh per year.

FUTURE STUDIES

- Reactors should be operated in different HRT values and optimisation of COD removal efficiency and HRT should be done. The lower HRT means, the lower investment cost for treatment plants, therefore, the lower HRT values should be investigated first.
- The reactors were operated in 35 °C in this study. COD treatment efficiency and gas production potential were determined for mesophilic conditions. Similar investigations should be done in thermophilic conditions in order to upgrade the COD removal efficiency and biogas production potential.
- Study should be repeated in pilot scale reactors operated on site. Minor problems caused from small equipments in lab scale can be excluded in pilot scale experiments and also problems due to the stalling of the waste can be eliminated by locating the system on site.
- Solid waste of pistachio should be investigated as a renewable energy source. When pistachio solid waste compared with wastewater of pistachio, solid waste has a greater potential as a renewable energy source due its high organic content.
- The residue sludge should be examined as an anaerobic organic fertilizer.
- Co-digestion opportunities of pistachio waste with other wastes produced locally (chicken manure etc.) should be investigated.
- With metagenomic methods, specialized seed culture or granule development should be investigated for pistachio processing wastewater and pistachio solid waste.

REFERENCES

- APHA, A. (2005). WEF, 2005. *Standard methods for the examination of water and wastewater*, 21.
- Atmakidis, T., & Kenig, E. Y. (2009). CFD-based analysis of the wall effect on the pressure drop in packed beds with moderate tube/particle diameter ratios in the laminar flow regime. *Chemical Engineering Journal*, 155(1), 404-410.
- Babadogan, G. (2007). Turkey Prime Minister, Foreign Trade Consulting. *Export Development Studies Center, Ankara*.
- Banihani, Q., Sierra-Alvarez, R., & Field, J. A. (2009). Nitrate and nitrite inhibition of methanogenesis during denitrification in granular biofilms and digested domestic sludges. *Biodegradation*, 20(6), 801-812.
- Behgar, Ghasemi, Naserian, Borzoie, & Fatollahi. (2011). Gamma radiation effects on phenolics, antioxidants activity and in vitro digestion of pistachio (*Pistachia vera*) hull. *Radiation Physics and Chemistry*, 80(9), 963-967. doi:<http://dx.doi.org/10.1016/j.radphyschem.2011.04.016>
- Behling, E., Diaz, A., Colina, G., Herrera, M., Gutierrez, E., Chacin, E., . . . Forster, C. (1997). Domestic wastewater treatment using a UASB reactor. *Bioresource technology*, 61(3), 239-245.
- Bitton, G. (1999). Sludge microbiology. *Wastewater Microbiology, Third Edition*, 321-344.
- Bitton, G. (2005). *Wastewater microbiology*: John Wiley & Sons.
- Bohluli, A., Nasserian, A., Valizadeh, R., & Eftekhari, S. F. (2010). The Chemical Composition, In Vitro Gas Production And Digestibility Of Pistachio By-Products.
- Bolzonella, D., Pavan, P., Battistoni, P., & Cecchi, F. (2005). Mesophilic anaerobic digestion of waste activated sludge: influence of the solid retention time in the wastewater treatment process. *Process Biochemistry*, 40(3), 1453-1460.
- Borja, R., & Banks, C. (1994). Anaerobic digestion of palm oil mill effluent using an up-flow anaerobic sludge blanket reactor. *Biomass and Bioenergy*, 6(5), 381-389.
- Borja, R., Banks, C. J., & Sánchez, E. (1996). Anaerobic treatment of palm oil mill effluent in a two-stage up-flow anaerobic sludge blanket (UASB) system. *Journal of Biotechnology*, 45(2), 125-135.

- Borroto, J., Dominguez, J., Griffith, J., Fick, M., & Leclerc, J. (2003). Technetium-99m as a tracer for the liquid RTD measurement in opaque anaerobic digester: application in a sugar wastewater treatment plant. *Chemical Engineering and Processing: Process Intensification*, 42(11), 857-865.
- Bouallagui, H., Touhami, Y., Cheikh, R. B., & Hamdi, M. (2005). Bioreactor performance in anaerobic digestion of fruit and vegetable wastes. *Process Biochemistry*, 40(3), 989-995.
- Brito, A., & Melo, L. (1999). Mass transfer coefficients within anaerobic biofilms: effects of external liquid velocity. *Water Research*, 33(17), 3673-3678.
- Caixeta, C. E., Cammarota, M. C., & Xavier, A. M. (2002). Slaughterhouse wastewater treatment: evaluation of a new three-phase separation system in a UASB reactor. *Bioresource technology*, 81(1), 61-69.
- Callander, I., & Barford, J. (1983). Precipitation, chelation, and the availability of metals as nutrients in anaerobic digestion. I. Methodology. *Biotechnology and Bioengineering*, 25(8), 1947-1957.
- Chahed, T., Dhifi, W., Hosni, K., Msaada, K., Kchouk, M. E., & Marzouk, B. (2008). Composition of Tunisian Pistachio Hull Essential Oil during Fruit Formation and Ripening. *Journal of Essential Oil Research*, 20(2), 122-125. doi:10.1080/10412905.2008.9699971
- Chaisri, R., Boonsawang, P., Prasertsan, P., & Chaiprapat, S. (2007). Effect of organic loading rate on methane and volatile fatty acids productions from anaerobic treatment of palm oil mill effluent in UASB and UFAF reactors. *Songklanakarin J. Sci. Technol*, 2, 311-323.
- Chávez P, C., Castillo L, R., Dendooven, L., & Escamilla-Silva, E. M. (2005). Poultry slaughter wastewater treatment with an up-flow anaerobic sludge blanket (UASB) reactor. *Bioresource technology*, 96(15), 1730-1736. doi:<http://dx.doi.org/10.1016/j.biortech.2004.08.017>
- Chong, S., Sen, T. K., Kayaalp, A., & Ang, H. M. (2012). The performance enhancements of upflow anaerobic sludge blanket (UASB) reactors for domestic sludge treatment—A State-of-the-art review. *Water Research*, 46(11), 3434-3470.
- Chou, H.-H., & Huang, J.-S. (2005). Comparative granule characteristics and biokinetics of sucrose-fed and phenol-fed UASB reactors. *Chemosphere*, 59(1), 107-116.
- Christiansen, N., Hendriksen, H. V., Jarvinen, K. T., & Ahring, B. K. (1995). Degradation of chlorinated aromatic compounds in UASB reactors. *Water Science and Technology*, 31(1), 249-259.

- Clarke, W. P., & Alibardi, L. (2010). Anaerobic digestion for the treatment of solid organic waste: what's hot and what's not. *Waste Management*, 30(10), 1761-1762. doi:<http://dx.doi.org/10.1016/j.wasman.2010.06.019>
- Çelik, İ., & Demirer, G. (2015). Biogas production from pistachio (*Pistacia vera* L.) processing waste. *Biocatalysis and Agricultural Biotechnology*, 4(4), 767-772.
- Dague, R. R. (1993). Anaerobic sequencing batch reactor: Google Patents.
- de Lemos Chernicharo, C. A. (2007). Anaerobic reactors. *Water Intelligence Online*, 6, 9781780402116.
- Demiral, I., Atilgan, N. G., & Şensöz, S. (2008). Production of biofuel from soft shell of pistachio (*Pistacia vera* L.). *Chemical Engineering Communications*, 196(1-2), 104-115.
- Demirer, G. (2016). Biogas Production from Pistachio (*Pistacia Vera* L.) De-Hulling Waste. *International Journal of Green Energy*(just-accepted).
- Demirer, G., & Chen, S. (2005). Two-phase anaerobic digestion of unscreened dairy manure. *Process Biochemistry*, 40(11), 3542-3549.
- Demirer, G., & Speece, R. (1998). Anaerobic biotransformation of four 3-carbon compounds (acrolein, acrylic acid, allyl alcohol and n-propanol) in UASB reactors. *Water Research*, 32(3), 747-759.
- Demirer, G. N., & Othman, M. (2008). Two-phase thermophilic acidification and mesophilic methanogenesis anaerobic digestion of waste-activated sludge. *Environmental Engineering Science*, 25(9), 1291-1300.
- Dogan, E., Dunaev, T., Erguder, T., & Demirer, G. (2009). Performance of leaching bed reactor converting the organic fraction of municipal solid waste to organic acids and alcohols. *Chemosphere*, 74(6), 797-803.
- Droste, R. L. (1997). *Theory and practice of water and wastewater treatment*: John Wiley & Sons Incorporated.
- Elias, D. A., Krumholz, L. R., Tanner, R. S., & Suflita, J. M. (1999). Estimation of methanogen biomass by quantitation of coenzyme M. *Applied and environmental microbiology*, 65(12), 5541-5545.
- Ergüder, T., Tezel, U., Güven, E., & Demirer, G. (2001). Anaerobic biotransformation and methane generation potential of cheese whey in batch and UASB reactors. *Waste Management*, 21(7), 643-650.
- Ergüder, T. H., & Demirer, G. N. (2008). Low-strength wastewater treatment with combined granular anaerobic and suspended aerobic cultures in upflow sludge blanket reactors. *Journal of Environmental Engineering*, 134(4), 295-303.

- Ergüder, T. H., Güven, E., & Demirer, G. N. (2000). Anaerobic treatment of olive mill wastes in batch reactors. *Process Biochemistry*, 36(3), 243-248. doi:[http://dx.doi.org/10.1016/S0032-9592\(00\)00205-3](http://dx.doi.org/10.1016/S0032-9592(00)00205-3)
- Fang, C., Boe, K., & Angelidaki, I. (2011). Biogas production from potato-juice, a by-product from potato-starch processing, in upflow anaerobic sludge blanket (UASB) and expanded granular sludge bed (EGSB) reactors. *Bioresource technology*, 102(10), 5734-5741.
- Fang, C., Sompong, O., Boe, K., & Angelidaki, I. (2011). Comparison of UASB and EGSB reactors performance, for treatment of raw and deoiled palm oil mill effluent (POME). *Journal of hazardous materials*, 189(1), 229-234.
- Fang, H. H., & Chui, H. (1993). Maximum COD loading capacity in UASB reactors at 37 C. *Journal of Environmental Engineering*, 119(1), 103-119.
- FAOSTAT. (2016). Food And Agriculture Organization Of The United Nations Statistics Division. Retrieved from <http://faostat3.fao.org/browse/Q/QC/E>
- Farhadian, M., Borghei, M., & Umrana, V. V. (2007). Treatment of beet sugar wastewater by UAFB bioprocess. *Bioresource technology*, 98(16), 3080-3083.
- Frankin, R. (2001). Full-scale experiences with anaerobic treatment of industrial wastewater. *Water Science and Technology*, 44(8), 1-6.
- García, H., Rico, C., García, P., & Rico, J. (2008). Flocculants effect in biomass retention in a UASB reactor treating dairy manure. *Bioresource technology*, 99(14), 6028-6036.
- Gavala, H., Kopsinis, H., Skiadas, I., Stamatelatou, K., & Lyberatos, G. (1999). Treatment of dairy wastewater using an upflow anaerobic sludge blanket reactor. *Journal of Agricultural Engineering Research*, 73(1), 59-63.
- Gerardi, M. H. (2003). *The microbiology of anaerobic digesters*: John Wiley & Sons.
- Goli, A. H., Barzegar, M., & Sahari, M. A. (2005). Antioxidant activity and total phenolic compounds of pistachio (*Pistachia vera*) hull extracts. *Food Chemistry*, 92(3), 521-525. doi:<http://dx.doi.org/10.1016/j.foodchem.2004.08.020>
- Gonzalez-Gil, G., Seghezzo, L., Lettinga, G., & Kleerebezem, R. (2001). Kinetics and mass-transfer phenomena in anaerobic granular sludge. *Biotechnology and Bioengineering*, 73(2), 125-134.
- Grady, C. (1985). Biodegradation: its measurement and microbiological basis. *Biotechnology and Bioengineering*, 27(5), 660-674.

- Grover, R., Marwaha, S., & Kennedy, J. (1999). Studies on the use of an anaerobic baffled reactor for the continuous anaerobic digestion of pulp and paper mill black liquors. *Process Biochemistry*, 34(6), 653-657.
- Güngör-Demirci, G., & Demirer, G. N. (2004). Effect of initial COD concentration, nutrient addition, temperature and microbial acclimation on anaerobic treatability of broiler and cattle manure. *Bioresource technology*, 93(2), 109-117.
- Hampannavar, U., & Shivayogimath, C. (2010). Anaerobic treatment of sugar industry wastewater by upflow anaerobic sludge blanket reactor at ambient temperature. *International journal of environmental sciences*, 1(4), 631.
- Harada, H., Uemura, S., Chen, A.-C., & Jayadevan, J. (1996). Anaerobic treatment of a recalcitrant distillery wastewater by a thermophilic UASB reactor. *Bioresource technology*, 55(3), 215-221.
- Hartmann, H., & Ahring, B. K. (2005). Anaerobic digestion of the organic fraction of municipal solid waste: influence of co-digestion with manure. *Water Research*, 39(8), 1543-1552.
- Huang, J. S., Jih, C. G., Lin, S. D., & Ting, W. H. (2003). Process kinetics of UASB reactors treating non-inhibitory substrate. *Journal of Chemical Technology and Biotechnology*, 78(7), 762-772.
- Hutnan, M., Drtil, M., Derco, J., Mrafkova, L., Hornak, M., & Mico, S. (2001). Two-step pilot-scale anaerobic treatment of sugar beet pulp. *Polish Journal of Environmental Studies*, 10(4), 237-244.
- Kalyuzhnyi, S., de los Santos, L. E., & Martinez, J. R. (1998). Anaerobic treatment of raw and preclarified potato-maize wastewaters in a USAB reactor. *Bioresource technology*, 66(3), 195-199.
- Kalyuzhnyi, S., Gladchenko, M., Mulder, A., & Versprille, B. (2006). DEAMOX—new biological nitrogen removal process based on anaerobic ammonia oxidation coupled to sulphide-driven conversion of nitrate into nitrite. *Water Research*, 40(19), 3637-3645.
- Kalyuzhnyi, S., Sklyar, V., Davlyatshina, M., Parshina, S., Simankova, M., Kostrikina, N., & Nozhevnikova, A. (1996). Organic removal and microbiological features of UASB-reactor under various organic loading rates. *Bioresource technology*, 55(1), 47-54.
- Karim, K., Klasson, K. T., Hoffmann, R., Drescher, S. R., DePaoli, D. W., & Al-Dahhan, M. (2005). Anaerobic digestion of animal waste: Effect of mixing. *Bioresource technology*, 96(14), 1607-1612.

- Katsoni, A., Mantzavinos, D., & Diamadopoulos, E. (2014). Sequential treatment of diluted olive pomace leachate by digestion in a pilot scale UASB reactor and BDD electrochemical oxidation. *Water Research*, 57, 76-86.
- Kaviyarasan, K. (2014). Application of UASB Reactor in Industrial Wastewater Treatment—A Review. *International Journal of Scientific & Engineering Research*, 5(1), 584.
- Kazemi, M., & Zand-Monfared, M. R. (2010). Furfural production from pistachio green hulls as agricultural residues. *Journal of Applied Chemical Researches Winter*, 3(12).
- Keyser, M., Witthuhn, R., Ronquest, L.-C., & Britz, T. (2003). Treatment of winery effluent with upflow anaerobic sludge blanket (UASB)—granular sludges enriched with *Enterobacter sakazakii*. *Biotechnology Letters*, 25(22), 1893-1898.
- Khanal, S. K. (2008). Anaerobic biotechnology for bioenergy production. *Principles and Application Willey and Blackwell*, 161-186.
- Kim, J. K., Oh, B. R., Chun, Y. N., & Kim, S. W. (2006). Effects of temperature and hydraulic retention time on anaerobic digestion of food waste. *Journal of Bioscience and Bioengineering*, 102(4), 328-332.
- Kitsos, H., Roberts, R., Jones, W., & Tornabene, T. (1992). An experimental study of mass diffusion and reaction rate in an anaerobic biofilm. *Biotechnology and Bioengineering*, 39(11), 1141-1146.
- Korsak, L., Cabezas, A., & Moreno, L. (2008). *A model of kinetics and mass transfer in an UASB reactor*. Paper presented at the The Fourth International Conference on Environmental Science and Technology, July 28-31, 2008, Houston, Texas, USA.
- Laubscher, A., Wentzel, M., Le Roux, J., & Ekama, G. (2001). Treatment of grain distillation wastewaters in an upflow anaerobic sludge bed (UASB) system. *Water SA*, 27(4), 433-444.
- Lettinga. (1995). Anaerobic digestion and wastewater treatment systems. *Antonie van leeuwenhoek*, 67(1), 3-28.
- Lettinga, G., & Pol, L. H. (1991). UASB-process design for various types of wastewaters. *Water Science and Technology*, 24(8), 87-107.
- Lettinga, G., Pol, L. H., Koster, I., Wiegant, W., De Zeeuw, W., Rinzema, A., . . . Hobma, S. (1984). High-rate anaerobic waste-water treatment using the UASB reactor under a wide range of temperature conditions. *Biotechnology and genetic engineering reviews*, 2(1), 253-284.

Lettinga, G., Roersma, R., Grin, P., Zeeuw, W. d., Pol, L. H., Velsen, L. v., . . . Zeeman, G. (1982). *Anaerobic treatment of sewage and low strength waste waters*. Paper presented at the Anaerobic digestion 1981: proceedings of the Second International Symposium on Anaerobic Digestion held in Travemünde, Federal Republic of Germany, on 6-11 September, 1981/editors, DE Hughes...[et al.].

Lettinga, G., Van Velsen, A., Hobma, S. W., De Zeeuw, W., & Klapwijk, A. (1980). Use of the upflow sludge blanket (USB) reactor concept for biological wastewater treatment, especially for anaerobic treatment. *Biotechnology and Bioengineering*, 22(4), 699-734.

Levenspiel, O. (1999). Chemical reaction engineering. *Industrial & engineering chemistry research*, 38(11), 4140-4143.

Liu, Y., & Tay, J.-H. (2002). The essential role of hydrodynamic shear force in the formation of biofilm and granular sludge. *Water Research*, 36(7), 1653-1665.

Liu, Y., & Tay, J.-H. (2004). State of the art of biogranulation technology for wastewater treatment. *Biotechnology Advances*, 22(7), 533-563. doi:<http://dx.doi.org/10.1016/j.biotechadv.2004.05.001>

McCarty, P. L. (1964). Anaerobic waste treatment fundamentals. *Public works*, 95(9), 107-112.

Monroy, O., Famá, G., Meraz, M., Montoya, L., & Macarie, H. (2000). Anaerobic digestion for wastewater treatment in Mexico: state of the technology. *Water Research*, 34(6), 1803-1816.

Moussavi, G., & Khosravi, R. (2010). Removal of cyanide from wastewater by adsorption onto pistachio hull wastes: Parametric experiments, kinetics and equilibrium analysis. *Journal of hazardous materials*, 183(1), 724-730.

Moussavi, G., & Khosravi, R. (2011). The removal of cationic dyes from aqueous solutions by adsorption onto pistachio hull waste. *Chemical Engineering Research and Design*, 89(10), 2182-2189.

Nadais, H., Capela, I., Arroja, L., & Duarte, A. (2005). Optimum cycle time for intermittent UASB reactors treating dairy wastewater. *Water Research*, 39(8), 1511-1518.

Nadais, H., Capela, I., Arroja, L., & Duarte, A. (2006). Treatment of dairy wastewater in UASB reactors inoculated with flocculent biomass. *Water SA*, 31(4), 603-608.

Nielsen, H. B., & Angelidaki, I. (2008). Strategies for optimizing recovery of the biogas process following ammonia inhibition. *Bioresource technology*, 99(17), 7995-8001.

Ocak, H. (2012) *TADIM Pistachio Producing Factory, The Director of Technical Services , Aydınlar Mahallesi 03005 No lu Cadde No:20 Şehitkamil 27850 Gaziantep , Phone : 0 262 672 75 70.*

Omstead, D. R., Jefferies, T. W., Naughton, R., & Gregor, H. P. (1980). *Membrane-controlled digestion: anaerobic production of methane and organic acids.*

Palenzuela-Rollon, A., Zeeman, G., Lubberding, H., Lettinga, G., & Alaerts, G. (2002). Treatment of fish processing wastewater in a one-or two-step upflow anaerobic sludge blanket (UASB) reactor. *Water Science and Technology*, 45(10), 207-212.

Parawira, W., Murto, M., Zvauya, R., & Mattiasson, B. (2004). Anaerobic batch digestion of solid potato waste alone and in combination with sugar beet leaves. *Renewable Energy*, 29(11), 1811-1823. doi:<http://dx.doi.org/10.1016/j.renene.2004.02.005>

Parawira, W., Murto, M., Zvauya, R., & Mattiasson, B. (2006). Comparative performance of a UASB reactor and an anaerobic packed-bed reactor when treating potato waste leachate. *Renewable Energy*, 31(6), 893-903.

Parkin, G. F., & Owen, W. F. (1986). Fundamentals of anaerobic digestion of wastewater sludges. *Journal of Environmental Engineering*, 112(5), 867-920.

Polat, R., Gezer, I., Guner, M., Dursun, E., Erdogan, D., & Bilim, H. C. (2007). Mechanical harvesting of pistachio nuts. *Journal of Food Engineering*, 79(4), 1131-1135. doi:<http://dx.doi.org/10.1016/j.jfoodeng.2006.03.023>

Potts, D. T. (2012). *A companion to the archaeology of the ancient Near East:* John Wiley & Sons.

Prashanth, S., Kumar, P., & Mehrotra, I. (2006). Anaerobic degradability: effect of particulate COD. *Journal of Environmental Engineering*, 132(4), 488-496.

Rajaei, A., Barzegar, M., Mobarez, A. M., Sahari, M. A., & Esfahani, Z. H. (2010). Antioxidant, anti-microbial and antimutagenicity activities of pistachio (*Pistachia vera*) green hull extract. *Food and chemical toxicology*, 48(1), 107-112.

Rajeshwari, K., Balakrishnan, M., Kansal, A., Lata, K., & Kishore, V. (2000). State-of-the-art of anaerobic digestion technology for industrial wastewater treatment. *Renewable and Sustainable Energy Reviews*, 4(2), 135-156.

Ramasamy, E., Gajalakshmi, S., Sanjeevi, R., Jithesh, M., & Abbasi, S. (2004). Feasibility studies on the treatment of dairy wastewaters with upflow anaerobic sludge blanket reactors. *Bioresource technology*, 93(2), 209-212.

- Rico, C., Muñoz, N., Fernández, J., & Rico, J. L. (2015). High-load anaerobic co-digestion of cheese whey and liquid fraction of dairy manure in a one-stage UASB process: limits in co-substrates ratio and organic loading rate. *Chemical Engineering Journal*, 262, 794-802.
- Romano, R. T., & Zhang, R. (2008). Co-digestion of onion juice and wastewater sludge using an anaerobic mixed biofilm reactor. *Bioresource technology*, 99(3), 631-637.
- Rosengarten Jr, F. (2004). *The book of edible nuts*: Courier Corporation.
- Sabbah, I., Marsook, T., & Basheer, S. (2004). The effect of pretreatment on anaerobic activity of olive mill wastewater using batch and continuous systems. *Process Biochemistry*, 39(12), 1947-1951.
- Sanchez, E., Borja, R., Travieso, L., Martín, A., & Colmenarejo, M. (2005). Effect of organic loading rate on the stability, operational parameters and performance of a secondary upflow anaerobic sludge bed reactor treating piggy waste. *Bioresource technology*, 96(3), 335-344.
- Sancinetti, G. P., Sader, L. T., Varesche, M. B. A., Amorim, E. L. C., Omena, S. P. F., & Silva, E. L. (2012). Phenol degradation in an anaerobic fluidized bed reactor packed with low density support materials. *Brazilian Journal of Chemical Engineering*, 29, 87-98.
- Sayed, S., de Zeeuw, W., & Lettinga, G. (1984). Anaerobic treatment of slaughterhouse waste using a flocculant sludge UASB reactor. *Agricultural wastes*, 11(3), 197-226.
- Schramm, W. A., Inc. (2014). World Pistachio Trade Report. *First Edition*.
- Schwarzenbach, R. P., Gschwend, P. M., & Imboden, D. M. (2005). *Environmental organic chemistry*: John Wiley & Sons.
- Singh, K. S., & Viraraghavan, T. (1998). Start-up and operation of UASB reactors at 20 C for municipal wastewater treatment. *Journal of fermentation and Bioengineering*, 85(6), 609-614.
- Singh, K. S., Viraraghavan, T., & Bhattacharyya, D. (2006). Sludge blanket height and flow pattern in UASB reactors: Temperature effects. *Journal of Environmental Engineering*, 132(8), 895-900.
- Soller, J. A., Olivieri, A. W., Crook, J., Cooper, R. C., Tchobanoglous, G., Parkin, R. T., . . . Eisenberg, J. N. (2003). Risk-based approach to evaluate the public health benefit of additional wastewater treatment. *Environmental science & technology*, 37(9), 1882-1891.

- Speece, R. E. (2008). *Anaerobic biotechnology and odor/corrosion control for municipalities and industries*: Archae Press.
- Tay, J.-H., & Zhang, X. (2000). A fast predicting neural fuzzy model for high-rate anaerobic wastewater treatment systems. *Water Research*, 34(11), 2849-2860.
- Tezel, U., Guven, E., Erguder, T. H., & Demirer, G. N. (2001). Sequential (anaerobic/aerobic) biological treatment of Dalaman SEKA Pulp and Paper Industry effluent. *Waste Management*, 21(8), 717-724.
- Ting, W.-H., & Huang, J.-S. (2006). Enhancement of denitrification in upflow sludge bed reactors with sludge wasting. *Journal of Environmental Engineering*, 132(4), 468-475.
- Torkian, A., Eqbali, A., & Hashemian, S. (2003). The effect of organic loading rate on the performance of UASB reactor treating slaughterhouse effluent. *Resources, Conservation and Recycling*, 40(1), 1-11.
- Torres, M. L., & Lloréns, M. d. C. E. (2008). Effect of alkaline pretreatment on anaerobic digestion of solid wastes. *Waste Management*, 28(11), 2229-2234.
- Uzal, N., Gökçay, C. F., & Demirer, G. N. (2003). Sequential (anaerobic/aerobic) biological treatment of malt whisky wastewater. *Process Biochemistry*, 39(3), 279-286.
- Verma, S. (2002). *Anaerobic digestion of biodegradable organics in municipal solid wastes*. Columbia University.
- Veronez, R., Orra, A., Ribeiro, R., Zaiat, M., Ratusznei, S., & Rodrigues, J. (2005). A simplified analysis of granule behavior in ASBR and UASB reactors treating low-strength synthetic wastewater. *Brazilian Journal of Chemical Engineering*, 22(3), 361-369.
- Vlyssides, A., Barampouti, E. M., & Mai, S. (2008). Determination of granule size distribution in a UASB reactor. *Journal of environmental management*, 86(4), 660-664.
- Wolmarans, B., & De Villiers, G. H. (2004). Start-up of a UASB effluent treatment plant on distillery wastewater. *Water SA*, 28(1), 63-68.
- Yan, Y.-G., & Tay, J.-H. (1997). Characterisation of the granulation process during UASB start-up. *Water Research*, 31(7), 1573-1580.
- Yen, H.-W., & Brune, D. E. (2007). Anaerobic co-digestion of algal sludge and waste paper to produce methane. *Bioresource technology*, 98(1), 130-134.

Yetilmezsoy, K., & Sakar, S. (2008). Improvement of COD and color removal from UASB treated poultry manure wastewater using Fenton's oxidation. *Journal of hazardous materials*, 151(2), 547-558.

Yilmazel, Y. D. (2009). *submitted by YASEMIN DiLSAD YILMAZEL in partial fulfillment of the. MIDDLE EAST TECHNICAL UNIVERSITY.*

Zeng, Y., Mu, S., Lou, S., Tartakovsky, B., Guiot, S., & Wu, P. (2005). Hydraulic modeling and axial dispersion analysis of UASB reactor. *Biochemical Engineering Journal*, 25(2), 113-123.

Zheng, Z. (2011). World production and trade of pistachios: the role of the US and factors affecting the export demand of US pistachios.

Zhou, L., & Mancl, K. (2007). Calculating Loadings Rates for Design of Small Flow Onsite Wastewater Treatment Systems Hydraulic vs. Organic Loading. *The Ohio State University*, 2.

Zoutberg, G. R., & Eker, Z. (1999). Anaerobic treatment of potato processing wastewater. *Water Science and Technology*, 40(1), 297-304.

APPENDIX A

CALIBRATION CURVES FOR BIOGAS COMPOSITION ANALYSIS

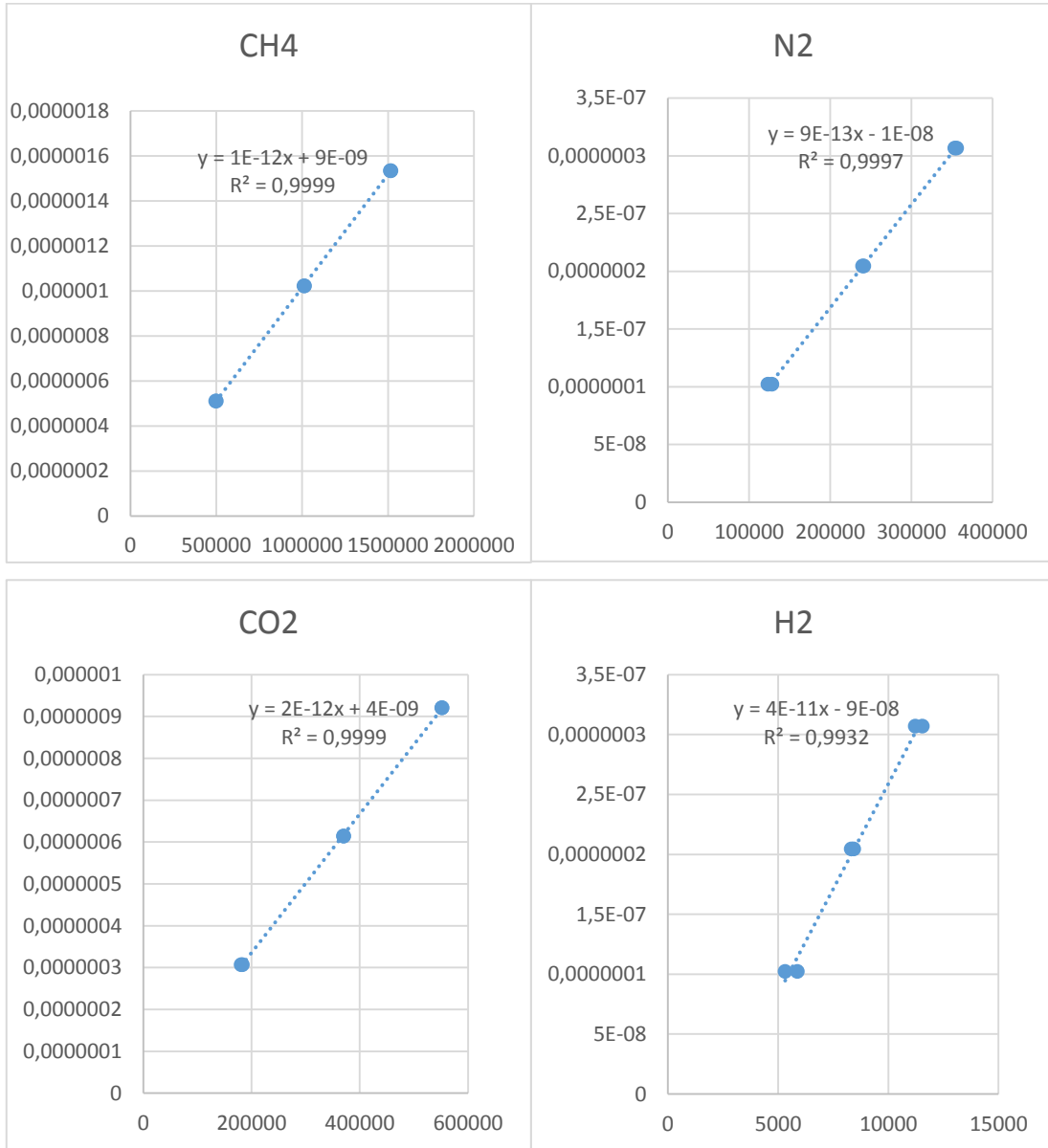

Figure A-1. Calibration Curves of CH₄, N₂, CO₂ & H₂ for Biogas Composition Analysis