

CORTICAL PROCESSES UNDERLYING METACONTRAST MASKING
ACROSS DIFFERENT CONTRAST POLARITIES

A THESIS SUBMITTED TO
THE GRADUATE SCHOOL OF INFORMATICS OF
THE MIDDLE EAST TECHNICAL UNIVERSITY

BY

ALAZ AYDIN

IN PARTIAL FULFILLMENT OF THE REQUIREMENTS FOR THE DEGREE
OF MASTER OF SCIENCE

IN

THE DEPARTMENT OF COGNITIVE SCIENCE

AUGUST 2018

**CORTICAL PROCESSES UNDERLYING METACONTRAST MASKING
ACROSS DIFFERENT CONTRAST POLARITIES**

Submitted by **Alaz Aydın** in partial fulfillment of the requirements for the degree of **Master of Science in Cognitive Science Department, Middle East Technical University** by,

Prof. Dr. Deniz Zeyrek Bozşahin
Dean, **Graduate School of Informatics**

Prof. Dr. Cem Bozşahin
Head of Department, **Cognitive Science**

Assist. Prof. Dr. Murat Perit Çakır
Supervisor, **Cognitive Science Dept., METU**

Assist. Prof. Dr. Hacı Hulusi Kafalıgönül
Co-Supervisor, **National Magnetic Resonance
Research Center (UMRAM), Bilkent University**

Examining Committee Members:

Prof. Dr. Cem Bozşahin
Cognitive Science Dept., METU

Assist. Prof. Dr. Murat Perit Çakır
Cognitive Science Dept., METU

Assist. Prof. Dr. Hacı Hulusi Kafalıgönül
National Magnetic Resonance Research
Center (UMRAM), Bilkent University

Assoc. Prof. Dr. Cengiz Acartürk
Cognitive Science Dept., METU

Assoc. Prof. Dr. Tolga Esat Özkurt
Health Informatics Dept., METU

Date: August 31, 2018

I hereby declare that all information in this document has been obtained and presented in accordance with academic rules and ethical conduct. I also declare that, as required by these rules and conduct, I have fully cited and referenced all material and results that are not original to this work.

Name, Last name: Alaz Aydın

Signature: _____

ABSTRACT

CORTICAL PROCESSES UNDERLYING METACONTRAST MASKING ACROSS DIFFERENT CONTRAST POLARITIES

Aydın, Alaz

MSc., Department of Cognitive Science

Supervisor: Assist. Prof. Dr. Murat Perit Çakır

Co-Supervisor: Assist. Prof. Dr. Hacı Hulusi Kafalığönül

August 2018, 72 pages

In this study a metacontrast masking experiment is conducted together with electroencephalography (EEG) recordings in order to investigate the neural mechanisms underlying visual masking phenomena. We employed a contour detection task under same and opposite target-mask contrast polarity conditions, together with varying stimulus onset asynchronies (SOA). Behavioral experiments resulted in unimodal type-A and type-B backward masking functions for opposite and same contrast polarity conditions, respectively. Relying on this difference as an indication of non-identical neural mechanisms, we collected EEG data under specific SOAs for an analysis of activation patterns under different contrast polarity masks. The behavioral results provided further evidence for sustained-transient dual-channel models of masking, specifically suggesting inhibition of on-sustained activity by off-transient activity, in accordance with previous research (Breitmeyer, 1978). Moreover, EEG analysis revealed significant differences in evoked potentials due to a change in mask contrast polarity at a short SOA of 10 ms, and compared polarity effects at two other critical SOA values of 50 ms and 200 ms.

Keywords: Visual Masking, Metacontrast Masking, Contrast Polarity, EEG

ÖZ

FARKLI KONTRAST POLARİTELERİNDEKİ METAKONTRAST MASKELEMENİN ALTINDA YATAN KORTİKAL SÜREÇLER

Aydın, Alaz

Yüksek Lisans, Bilişsel Bilimler Bölümü

Tez Yöneticisi: Doktor Öğretim Üyesi Murat Perit Çakır

Eş Tez Yöneticisi: Doktor Öğretim Üyesi Hacı Hulusi Kafalığönül

Ağustos 2018, 72 sayfa

Bu çalışmada görsel maskelemenin altında yatan nöral mekanizmaları anlamak için elektroansefalografi (EEG) kaydı ile birlikte metakontrast maskeleme deneyi yapılmıştır. Deneyde özelliğe dayalı tespit görevi farklı hedef-maske kontrast polarite durumları ve değişen uyaran başlangıç asenkronileri altında verilmiştir. Davranışsal deneylerde ters ve aynı polarite durumları için sırasıyla tek modlu tip-A ve tip-B geriye dönük maskeleme fonksiyonları elde edilmiştir. Bu fark göz önünde bulundurularak, EEG verisi farklı nöral süreçlerin analizi için belirli uyaran başlangıç asenkronilerinde toplanmıştır. Davranışsal veriler maskelemenin sürekli-geçici çift kanal modelleri için literatürle uyumlu (Breitmeyer, 1978) bulgular sunmuş, açık-sürekli kanal üzerinde kapalı-geçici aktivitenin azaltma etkisini örneklemiştir. Ek olarak, EEG analizleri 10 ms asenkronideki kontrast polaritesine bağlı tepkisel potansiyeller arasındaki önemli farkları göstermiş, ve polarite etkisini diğer iki kritik asenkroni değerinde (50 ms ve 200 ms) karşılaştırmıştır.

Anahtar Sözcükler: Görsel Maskeleme, Metakontrast Maskeleme, Kontrast Polaritesi, EEG

To My Family

ACKNOWLEDGMENTS

First of all, I would like to thank to my co-supervisor Assist. Prof. Dr. Hacı Hulusi Kafalıgönül for introducing me to the field of visual masking, and providing a collaborative research environment at Cortical Dynamics and Perception Lab, Bilkent University.

I would also like to thank to my supervisor Assist. Prof. Dr. Murat Perit Çakır for the informative courses he offered during my M.S. study and his contributions in this thesis.

Besides my supervisors, I would like to thank all the faculty members for providing education from a large variety of perspectives in Cognitive Science.

Finally, I would like to thank my colleagues Ayşenur Karaduman, Esra Nur Çatak, Gaye Başaran, Utku Kaya, Sibel Akyüz and Mert Özkan for their generous support.

TABLE OF CONTENTS

ABSTRACT.....	iv
ÖZ.....	v
DEDICATION.....	vi
ACKNOWLEDGMENTS	vii
TABLE OF CONTENTS.....	viii
LIST OF FIGURES	x
CHAPTERS	
1 INTRODUCTION.....	1
1.1 Overview of the Visual System	1
1.2 Visual Masking	4
1.3 Theories and Models of Visual Masking.....	7
1.4 EEG and Masking	8
1.5 Specific Aims	10
1.6 Specific Research Questions.....	11
1) How different target-mask contrast polarities affect metacontrast masking in a contour detection task?	11
2) What are the neural correlates of metacontrast masking specific to: (a) the difference in stimulus contrast polarity, and (b) target-mask temporal asynchrony?	12
1.7 Organization of the Thesis	13
2 EFFECTS OF CONTRAST POLARITY IN METACONTRAST MASKING .	15
2.1 Introduction.....	15
2.2 Experiment: Effect of Contrast Polarity on Metacontrast Masking in Contour Discrimination Judgements	15
2.2.1 Methods	15
2.2.2 Behavioral Data Analysis	20

2.2.3	Results and Discussion.....	21
3	ELECTROPHYSIOLOGICAL CORRELATES OF CHANGES IN METACONTRAST MASKING SPECIFIC TO STIMULUS CONTRAST POLARITY	27
3.1	Introduction.....	27
3.2	Methods	28
3.3	Data Analysis and Results.....	30
4	GENERAL DISCUSSION.....	39
4.1	Discussion on Behavioral Prestudy Experiment.....	39
4.2	Discussion on the Main EEG Experiment.....	42
4.3	Implications for Cognitive Science.....	43
	REFERENCES.....	47
	APPENDICES	
	APPENDIX A.....	53
A.1	Contrast Polarity Comparisons	53
A.2	SOA Comparisons Within Each Contrast Polarity Condition	60
A.3	Mask-Only Conditions.....	64
A.4	Time Window Topographies.....	66
	APPENDIX B	69
B.1	Preprocessing Steps for a Single Subject	69

LIST OF FIGURES

Figure 1.1. Projections of P and M pathways from retina to visual cortex	2
Figure 1.2. Diagram of the functional segregation of the primate visual.....	3
Figure 1.3. Depictions of temporal relations between target and mask stimuli	4
Figure 1.4. Example target and mask pair	5
Figure 1.5. Example metacontrast masking functions	6
Figure 1.6. Lumped representation of RECOD model.....	8
Figure 1.7. Depiction of the specificity of the study	11
Figure 2.1. Stimuli configurations and spatial arrangement.....	17
Figure 2.2. Depiction of consecutive frames in a same-polarity condition.....	18
Figure 2.3. Depiction of consecutive frames in an opposite-polarity condition	19
Figure 2.4. Masking functions obtained.....	22
Figure 2.5. Response biases.....	23
Figure 2.6. Criterion content variation	24
Figure 2.7. Sensitivity curves	24
Figure 2.8. Mean response time curves	25
Figure 2.9. Mean performance curves of two clusters	26
Figure 3.1. Masking functions for EEG experiment	30
Figure 3.2. Response times for EEG experiment.....	31

Figure 3.3. T-test results for contrast polarity comparisons.....	34
Figure 3.4. ANOVA results with contrast polarity and SOA as factors.....	35
Figure 3.5. Activation topographies within selected time windows	36
Figure 3.6. Difference waves for occipital site electrodes.....	37
Figure 3.7. Difference waves for specific electrode sites	38
Figure 4.1. Depiction of inter-channel inhibition.....	41
Figure 4.2. ERPs for TM presentation for SOA = 10 ms.....	42
Figure A.1. T-test results on TM ERPs for contrast polarity conditions at an SOA of 10 ms	54
Figure A.2. T-test results on difference waves for contrast polarity conditions at 10 ms SOA	55
Figure A.3. T-test results on TM ERPs for contrast polarity conditions at an SOA of 50 ms	56
Figure A.4. T-test results on difference waves for contrast polarity conditions at 50 ms SOA	57
Figure A.5. T-test results on TM ERPs for contrast polarity conditions at an SOA of 200 ms	58
Figure A.6. T-test results on difference waves for contrast polarity conditions at 200 ms SOA	59
Figure A.7. T-test results on difference waves for SOA = 10 ms and 50 ms conditions at both polarities	61
Figure A.8. T-test results on difference waves for SOA = 10 ms and 200 ms conditions at both polarities	62

Figure A.9. T-test results on difference waves for SOA = 50 ms and 200 ms conditions at both polarities 63

Figure A.10. T-test results for mask-only trials..... 64

Figure A.11. Activation topographies and ERPs for different mask polarities on mask-only trials 65

Figure A.12. Topographies of averaged time windows, and their differences at SOA = 10 ms 66

Figure A.13. Topographies of averaged time windows, and their differences at SOA = 10 ms 67

Figure A.14. Topographies of averaged time windows, and their differences at SOA = 10 ms 68

Figure B.1. Power spectrum density 69

Figure B.2. Scalp topography for power distribution 70

Figure B.3. Noisy channel contaminating scalp topography 70

Figure B.4. A trial epoch with blink at the baseline region 71

Figure B.5. Raster plot of electrode Fp1 72

Figure B.6. ERPs for different conditions..... 72

CHAPTER 1

1 INTRODUCTION

1.1 Overview of the Visual System

A considerable amount of research has been done on the anatomy and physiology of the visual system. This section will review the organization of visual system in the light of its building blocks, which are instrumental in theorizing about visual masking phenomena.

From retinal level to higher level areas of the visual cortex, it is possible to trace partially distinct mechanisms with respect to their temporal and spatial characteristics. Physiological differences in the early visual system imposes functional segregation in processing features of an object (Livingstone & Hubel, 1988). Parallel channels, extracting different attributes from the visual scene, originate in the retina (Schiller, 2010). These channels are mainly due to two contrasting organization: presence of ON-OFF, and midget-parasol ganglion cells. Midget and parasol ganglion cells have both ON and OFF subclasses. Midget cell receptive fields are small; they respond in a slow-tonic, sustained manner. Parasol cells' receptive fields are large; they respond in a fast-phasic, transient manner. Midget and parasol cells project to lateral geniculate nucleus (LGN), and create a layered structure. The afferent pathways created by midget and parasol cell projections are called parvocellular (P) and magnocellular (M) pathways, respectively. Receptive field mapping is preserved, however information from the left eye projects to the right coronal section of the LGN, and there is contra-/ipsi-lateral alternation between layers. There are six layers at a foveal cross-section of LGN: four parvocellular and two magnocellular. As eccentricity increases from fovea to periphery, the P/M ratio decreases from 8 to 1, approximately at 18° of visual angle (Schiller, 2010). Such organization is in accordance with evolutionary perspectives of vision, enabling the organism to

detect changes at the periphery rapidly without detail and provide the finer details at the center, relatively slowly.

M and P pathways project from LGN to layers 4C α and 4C β of V1. Anatomical segregation of P and M pathways at cortical areas has also been shown by cytochrome oxidase (CO) staining, where P layers project to V1 (blob and interblob) and to V2 (inter-stripe and thin-stripe) areas, and M layers project to V2 (thick-stripe) (Lamme & Roelfsema, 2000). Higher cortical areas segregate into ventral and dorsal pathways, which are dominated by the inputs from parvo- and magno- pathways respectively. Figure 1.1 shows the relations among these regions.

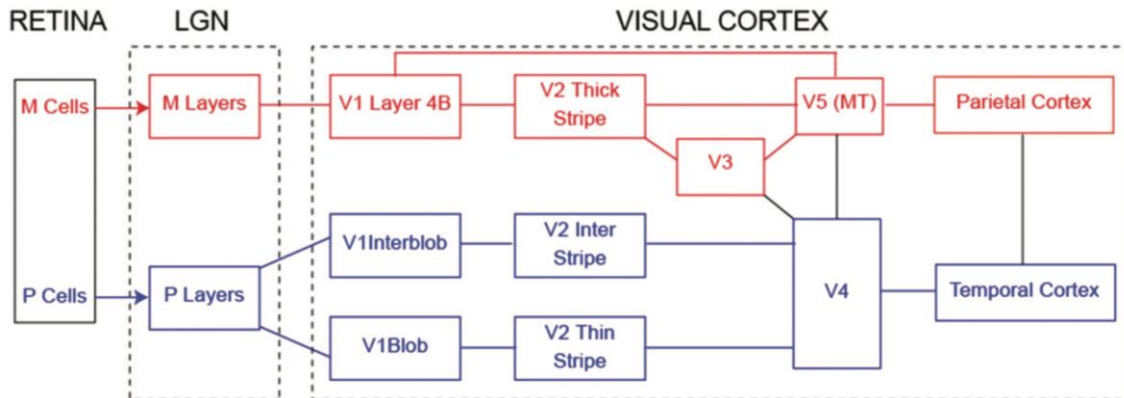

Figure 1.1. Projections of P and M pathways from retina to visual cortex: ventral pathway is P-cell mediated projecting to temporal cortex; dorsal pathway is M-cell mediated projecting to parietal cortex (Adapted from Kafaligonul, 2014).

Due to these temporal and spatial dissociations, researchers were able to determine functional pathways. In a well-known lesion study on the monkey brain, a dorsal pathway lesion impaired landmark discrimination, whereas a ventral pathway lesion impaired object discrimination; revealing distinct pathways for locating and identifying objects (Ungerleider & Mishkin, 1982). Similar behavioral dissociation studies employed blocking agents in the retina and selective lesioning at LGN to reveal the functions of ON/OFF channels and parvocellular/magnocellular pathways, respectively (Schiller, 2010). In addition, pathways specific to color, form, motion and binocularity are identified (Livingstone & Hubel, 1988). Figure 1.2 represents retino-cortical organization in terms of this functional segregation.

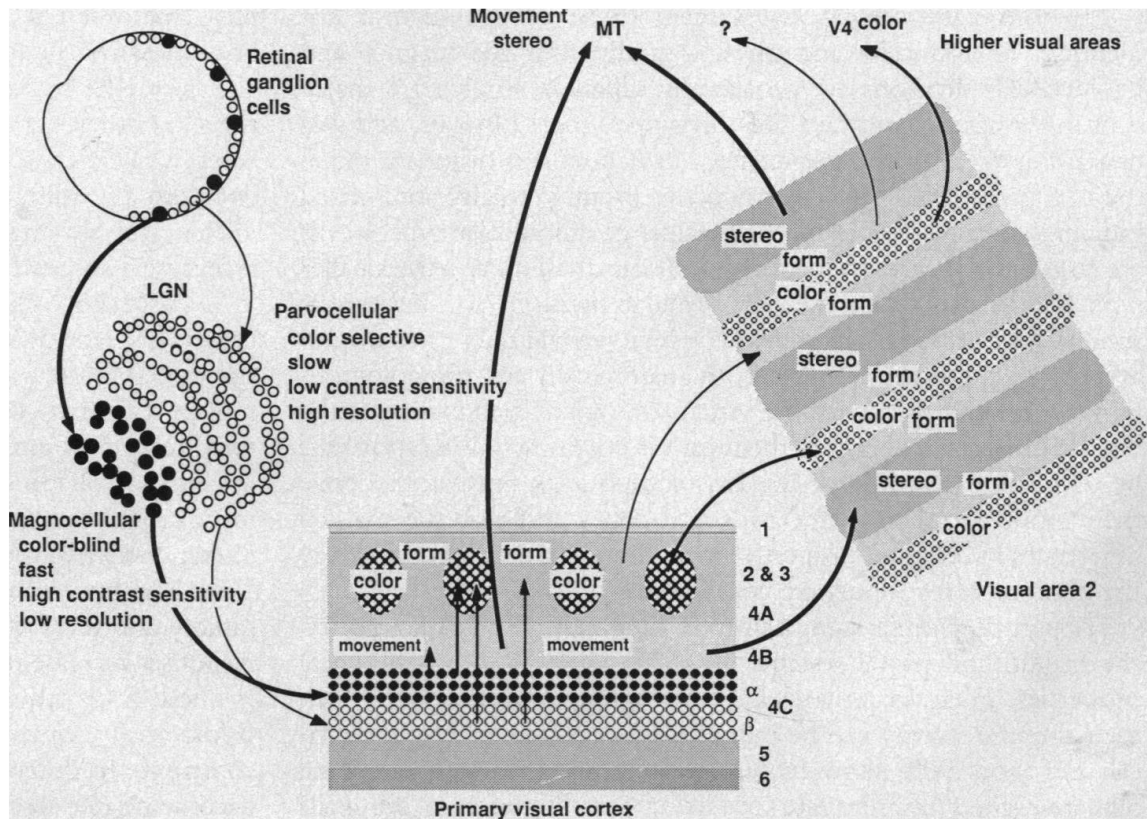

Figure 1.2. Diagram of the functional segregation of the primate visual system (Adapted from Livingstone & Hubel, 1988).

An evident distinction is between spatial and temporal frequency resolutions of the two systems originating from midget and parasol cells. Parvocellular pathway is better at discriminating detailed features such as color, texture, and form, occurring at high spatial frequency. On the other hand, magnocellular pathway is better at discriminating events such as flicker and fast, low-contrast motion occurring at a higher temporal frequency (Schiller, 2013). Later in the following sections, importance of these two systems in theorizing about masking phenomena will be discussed in detail.

1.2 Visual Masking

In visual masking, stimuli are presented in a specific temporal and spatial order. The stimulus on which perceptual judgment is to be made is called the target; the stimulus affecting the perception of the target is called the mask (Breitmeyer & Ogmen, 2006). There is a diversity in spatial and temporal variables governing target visibility, and visual masking research aims an exhaustive layout of relations between the stimuli and the percept, in terms of these variables.

It is possible to present the target before or after the mask. If it is shown before the mask, it is called backward masking; if shown after the mask, it is called forward masking (Breitmeyer & Ogmen, 2006). In order to quantify the temporal organization of stimuli, it is possible to use the following measures: inter-stimulus interval (ISI), stimulus onset asynchrony (SOA), and stimulus termination asynchrony (STA). Such temporal relations are depicted in figure 1.3, among which SOA has been widely used in quantifying masking functions.

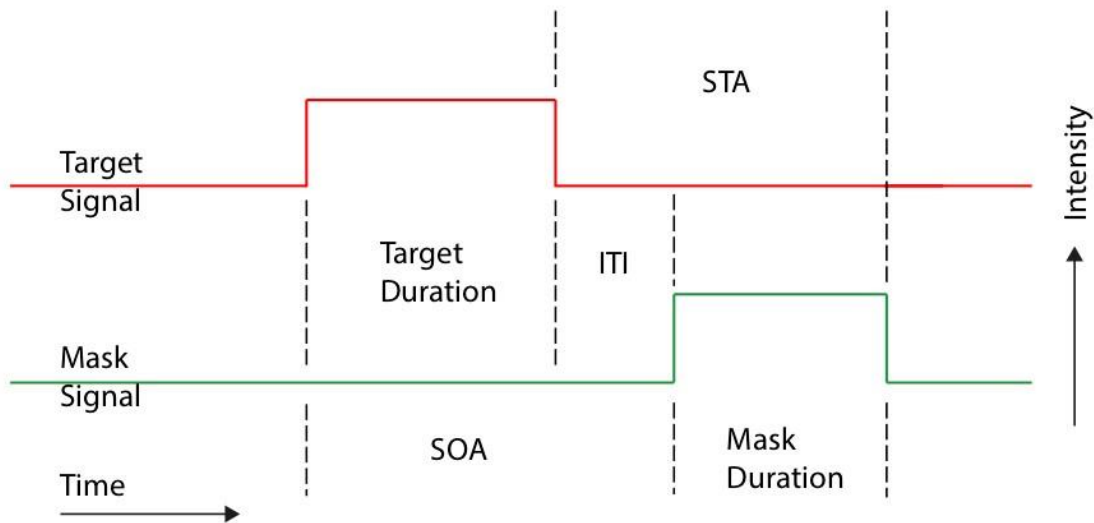

Figure 1.3. Depictions of temporal relations between target and mask stimuli.

The target can be masked by noise, and structure (Breitmeyer & Ogmen, 2006). In masking by noise, mask is designed in the form of random dots or alike, spatially overlapping with the target, such that it has very little structural relationship to target contours (Breitmeyer & Ogmen, 2006). In masking by structure, the mask shares figural characteristics with the target, and if there is

contour contiguity between the target and the mask, special cases of forward and backward masking occurs: paracontrast and metacontrast, respectively (Breitmeyer & Ogmen, 2006). In figure 1.4, a commonly used target-mask pair with contour contiguity is presented.

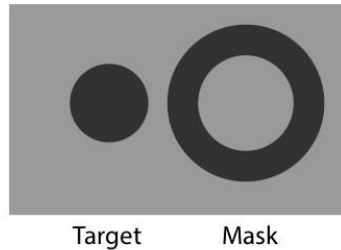

Figure 1.4. Example target and mask pair showing contour contiguity employed largely in para-/meta-contrast studies.

Central to the entire discipline of visual masking is the concept of masking function. A masking function highlights the relation between the visibility of the target and the target-mask temporal asynchrony. Visibility is quantified by the performance on the task and indicates the amount of masking present. Performance can be measured by accuracy and response time. Existing research recognizes the critical role played by the SOA in quantifying the temporal relation and classifies masking functions based on their morphology. As shown in figure 1.5, typical metacontrast masking functions are: i) unimodal type A (monotonic) and type B (non-monotonic), ii) bimodal, and iii) multimodal (Breitmeyer & Ogmen, 2006). The morphology of masking function is affected by a great number of variables (see Breitmeyer & Ogmen, 2006 for details) such as task parameters and criterion content; stimulus wavelength, duration, intensity, contrast, orientation, size, and location; target-mask spatial separation, background luminance and adaptation level, viewing conditions, and subject to investigation in this thesis: stimulus contrast polarity.

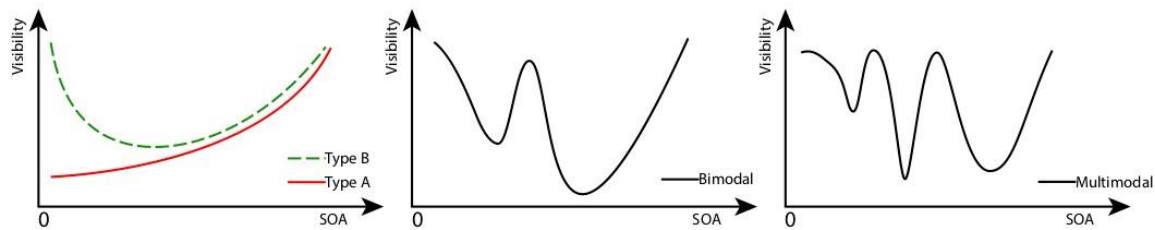

Figure 1.5. Example metacontrast masking functions.

According to Bloch's law (1885), the visual system temporally integrates its input, defining stimulus energy as a product of duration and intensity; and, according to a review by Weisstein (1972), the difference between type A and type B masking functions depends on a difference in mask-to-target(M/T) energy ratio (as cited in Breitmeyer & Ogmen, 2006). Specifically, if the mask energy is less than or equal to the target energy, then type B; otherwise type A functions are obtained. Earlier investigations of masking phenomena considered differences in masking functions, and theorized about their underlying mechanisms. Turvey (1973) argued that there are two distinct types of masking, namely the integration and interruption masking. In integration account of backward masking, the target and mask form a single composite due to the limited temporal resolution of iconic memory, thus perception of target features are impaired. This is generally attributed to a 'peripheral' (retinal) process, and masking functions are monotonic. However, if processing of the target is interrupted by the mask, maximally at a specific time after presentation of the target, as indicated by a U-shaped masking function, it is called interruption masking, and this process is considered to be a more 'central' (cortical) process. This line of reasoning was supported by the monoptic and dichoptic presentations of mask stimuli. In interruption masking processes, impairments in target perception remained present in both monoptic and dichoptic presentations; whereas integration masking processes were absent when target-mask were presented dichoptically.

Numerous studies have attempted to explain the effects of aforementioned variables on metacontrast masking functions, and further utilized them to provide evidence for different mechanisms of perception (Breitmeyer & Ogmen, 2000). Among others, criterion content is an important variable. It has been shown that only when the task is changed from simple detection of the target to a task requiring identification of features of the target related to surface or

contour, masking is operational (Ogmen et al., 2003). Investigations revealed differences further, between contour- and brightness-processing (Breitmeyer et al., 2006) by using brightness-matching and contour-identification tasks and comparing the resulting masking functions. There is also evidence for different masking functions resulting from a change in target size and contrast polarity within a brightness matching task (Breitmeyer et al., 2008).

This thesis study focuses on the effect of target-mask contrast polarity in terms of a contour detection task. Forthcoming chapters will address the rationale behind this specific methodological design.

1.3 Theories and Models of Visual Masking

There are various theories and models of masking mainly regarding the following: (i) integration of target-mask sequence into a single percept, (ii) interruption of the processes mediated by target being interrupted by the mask due to temporal asynchrony of magnocellular and parvocellular pathway activations, (iii) lateral inhibition within a channel processing target and mask signals, (iv) attention shifts, and (v) thalamocortical relays (Bachmann & Francis, 2013). In terms of feedforward and feedback mechanisms, two main lines of theories exist: one suggests masking is due to lateral inhibition taking place in feedforward processing between target and mask, whereas the other suggests interruption of feedback processing of target by the mask (Silverstein, 2015).

Distinct temporal response properties of magnocellular and parvocellular pathways have been instrumental in modelling the dynamics of masking. An early model capitalizing on these biological building blocks is the sustained-transient dual-channel model (Breitmeyer & Ganz, 1976). The model purports that masking can occur via within-channel inhibition and between-channel inhibition, and can account for type A and type B metacontrast masking functions (Breitmeyer & Ogmen, 2006). The retino-cortical dynamics(RECOD) model (Ogmen, 1993) considers the non-linear feedback loops in the cortex, and builds on the dual-channel model. Feedback loops might make a dynamic system unstable, from a control theory point of view, and RECOD model (as depicted in figure 1.6) aims for an account of conflicting tendencies generated by afferent, stimulus-dependent input signals and efferent, percept-dependent activities (Breitmeyer & Ogmen, 2006). A similar model, specific to metacontrast

masking, employs nested and hierarchical attractor memories (AM) which can mutually exclude each other via lateral and di-synaptic inhibition (Silverstein, 2015). Such that an AM for the target, which is partially stimulated, requires excitatory feedback loops in order to get fully activated (for a duration of ~50ms), and due to competition with other AMs, such as the one due to mask presentation, target AM fails to get fully activated and masking occurs.

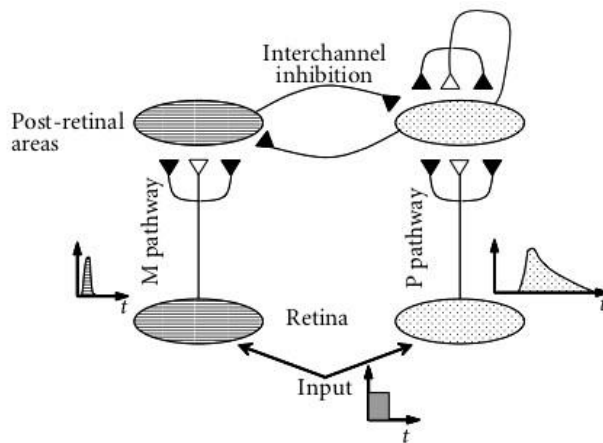

Figure 1.6. Lumped representation of the RECOD model (Adapted from Breitmeyer & Ogmen, 2006). Black and white triangles represent inhibitory and excitatory connections, respectively.

Given vast amount of theories and models of masking, RECOD model is of special interest due to its capability to get “unlumped” regarding both stimulus and task related processes in masking (for a review comparing metacontrast masking models see Breitmeyer & Ogmen, 2006). A study by Breitmeyer et al. (2006) shows how the model can be unlumped to account for early contour and late surface processing pathways, and inhibition of the target mediated sustained contour processing by mask-mediated magnocellular pathway transient activity.

1.4 EEG and Masking

Early neurophysiological studies on masking mainly considered visually evoked potential (VEP) correlates of subjective brightness. A first study found an increase in the amplitude and latency of the VEP due to target stimulus

intensity increase, but failed to correlate such attributes with perceived brightness (Schiller & Chorover, 1966). However, using foveal stimulation, Vaughan and Silverstein (1968) found attenuation of the VEPs due to masking at about 200 ms after the first stimulus. Further studies considered ERP components and found reduced amplitude of P2 with backward masking effect (Andreassi et al., 1976), while early components such as C1 and C2 remained unchanged (Jeffreys & Musselwhite, 1986). Consequently, Bridgeman (1988) suggested metacontrast correlates to be found in a range of about 160-260 ms, regarding single neuron activities, which are of striate origin.

Metacontrast masking stimuli were also used in visual awareness research. Such that researchers suggested that prestimulus alpha phase makes subsequent stimuli either visible or not (Mathewson et al., 2009). A review on ERP correlates of visual consciousness (Railo et al., 2011) presents typical ERP component differences in aware and unaware trials as an increased positivity in P1 at about 100 ms and an increased negativity in N1, also called visual awareness negativity (VAN) at about 200 ms, and an increased late positivity (LP) at later time points. However, other studies suggest that it is possible to argue that such LP might be due to a difference in confidence levels rather than a specific correlate of visual awareness (Lamy et al., 2009). In addition, Fahrenfort et al. (2007) suggested interruption of feedback mechanisms in visual cortex in 110-140 ms range, which is preceded by a completely unconscious pre-110 ms feedforward stage.

Use of masking in consciousness research, however is subject to controversy regarding differences in theories of visual consciousness. In their paper Breitmeyer and Tapia (2011) considers the roles of contour and surface processing in which they provide a difference in temporal dynamics of such processes in conscious and nonconscious levels, such that contour processing precedes surface processing at nonconscious level, but vice versa at conscious level. Further, Ögmen et al. (2006) suggests that metacontrast suppression mechanism operates at a nonconscious level of processing (as cited in Breitmeyer & Tapia, 2011). Thus, use of masking as a research tool in neural correlates of consciousness requires caution, regarding the still-subjective definitions of awareness, consciousness and alike.

1.5 Specific Aims

One of the most fundamental aspects of perception is detecting contrast. Humans and other species are able to sense the changes in their environment in different modalities through various transducers within specific ranges of resolutions along spatial and temporal dimensions. How a sensory, especially the visual, system accomplishes processing vast amount of information at different levels to form percepts of physical world is subject to extensive research. Visual system employs receptive field organization of neuronal firing (Hartline, 1938) as computational units (McCulloch & Pitts, 1943) within distributed and hierarchical processing in the visual cortex (Felleman & Van Essen, 1991), such that feedforward and feedback flow of information in this hierarchy provides the necessary computations for identifying distinct features of objects in nature such as form, texture, color and motion.

Visual masking research aims for an objective investigation of these processes in terms of the variables governing the underlying dynamics. In visual masking, visibility of one stimulus (target) is reduced by a second stimulus (mask) if presented in a particular spatiotemporal order. The perceptual judgment is made on the target about features such as brightness or contour detail. The mask is arranged specifically in time and space to alter the visibility of the target, quantified by a masking function. In this study a metacontrast mask was used for altering the perceptual judgment on the contour detail, where the visibility was quantified by both response time and accuracy measures, such that the effect of contrast polarity on masking function was investigated (see figure 1.7).

In addition to serving as a methodological tool for fields such as psychophysics and consciousness research, the phenomenon of visual masking itself is worthy of empirical and theoretical investigation (Breitmeyer & Ogmen, 2006). There are two primary aims of this study: 1. To investigate the effect of target-mask contrast polarity in metacontrast masking and provide behavioral evidence for theories of masking, 2. To provide electrophysiological data of the working brain for a better understanding of the cortical processes underlying this phenomenon.

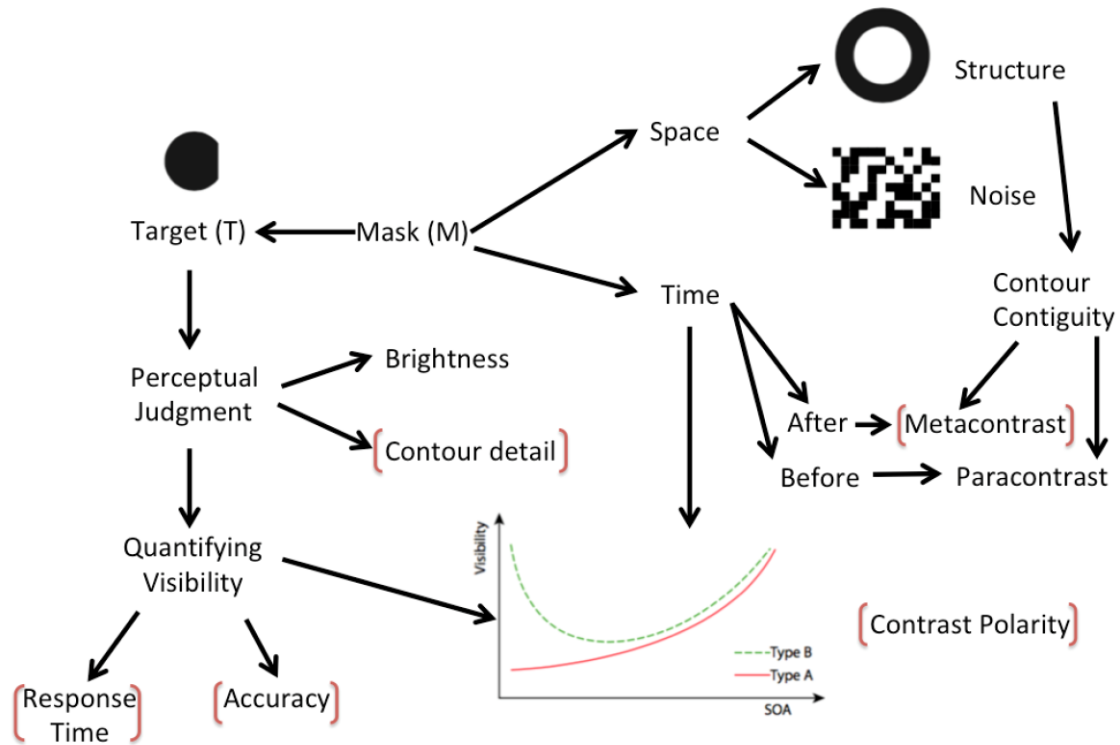

Figure 1.7. Depiction of the specificity of the study.

1.6 Specific Research Questions

The specific research questions that will be addressed in this thesis are as follows:

- 1) How different target-mask contrast polarities affect metacontrast masking in a contour detection task?

Visual masking experiments are widely employed in research considering various aspects of cognition such as perception, attention, and consciousness (Bachmann & Francis, 2013). However, the masking phenomena and underlying mechanisms are not fully understood yet. Masking is generally quantified by a measure of performance on a visual task, and variation of performance with manipulated variables within an experiment provides evidence both on the functional role of those variables and on the task-related perceptual mechanisms. There are numerous stimulus and task variables governing masking phenomena, as discussed in the preceding sections. Examples include

studies employing different task parameters and associated criterion contents to reveal contrasts between processing certain features of visual stimuli such as brightness and contour (Breitmeyer et al., 2006); and studies employing differences in stimulus attributes to provide evidence for theorizing about the mechanisms of visual perception, such as inter-channel inhibition (Breitmeyer, 1978).

Among many other stimulus variables governing masking phenomena, contrast polarity is of special interest. Specifically, given that an increase or a decrease in stimulus luminance can selectively activate ON and OFF pathways in the visual system (Schiller, 2010), manipulating stimulus contrasts in a masking experiment contributes to a better understanding on the role of such pathways in visual masking.

However, research still results in conflicting conclusions in terms of mechanisms governing masking phenomena. Particularly, a failure in detecting masking effect with opposite mask polarity leads researchers to conclude absence of inhibition between ON and OFF pathways in metacontrast masking (Becker & Anstis, 2004). On the other hand, experimental designs regarding larger ranges of temporal relations of target and mask reveals contradictory results (Breitmeyer et al., 2008; Breitmeyer, 1978). In order to provide further evidence on the mechanisms of masking regarding ON/OFF pathway organization and contour detection, in this study, a metacontrast masking experiment is employed in which target-mask contrast polarity is manipulated under a contour detection task.

2) What are the neural correlates of metacontrast masking specific to: (a) the difference in stimulus contrast polarity, and (b) target-mask temporal asynchrony?

Visual masking provides the ability to make a stimulus either visible or invisible to the viewer, by manipulating certain parameters of stimulation. Differences in neural activity among seen and unseen situations of a visual stimulus provide valuable information for theories regarding formation of a conscious percept. Sub-second processes underlying percept formation are captured by electroencephalography (EEG) recordings providing high temporal resolution. As a result, event-related brain potential (ERP) correlates of such processes are

widely studied (Koivisto & Revonsuo, 2010). This line of research is designated as neural correlates of consciousness (NCC) research.

In addition to such considerations, the focus of this thesis is on the correlates of masking processes. There is a diversity in theories of visual masking (Breitmeyer & Ogmen, 2006) mainly regarding integration, interruption, inter- and intra- channel inhibition, attention, and thalamocortical modulation (Bachmann & Francis, 2013). Such theories have both subcortical and cortical accounts, and cortical activation patterns revealed by EEG recordings provide valuable insights.

To date, several studies have investigated visual masking, and its relation to evoked potentials. An early study regarding metacontrast has shown that the evoked potential (EP) to a target-mask sequence is not equal to a synthetic EP created by summation of EP's generated in separate presentations of target and mask (Schiller & Chorover, 1966). This result suggested that there are cortical activities specific to visual masking. In line with this finding, a recent study suggests that masking interrupts feedback processing in visual cortex (Fahrenfort et al., 2007).

Specific to our study, we found different masking functions induced by a change in target-mask contrast polarity in a behavioral experiment, and in order to investigate the differences in cortical activity we focused on critical target-mask temporal asynchronies for further clarification of the dynamics of masking processes.

1.7 Organization of the Thesis

In this chapter an overview of visual masking was presented together with its biological and theoretical accounts. In the forthcoming chapters the experiments will be explained. In chapter two, the prestudy behavioral experiment is explained for a basis of obtaining masking functions with the stimuli designed. The results are discussed in terms of dual-channel theories of masking regarding ON and OFF pathways. In chapter three, the main EEG experiment methods and results are provided for an investigation of evoked potential at critical SOA values for different contrast polarity conditions. Finally, in chapter four, overall discussion is provided.

CHAPTER 2

2 EFFECTS OF CONTRAST POLARITY IN METACONTRAST MASKING

2.1 Introduction

A focus on the contrast polarity difference and its effects on masking was also investigated by previous studies. Breitmeyer (1978) used both white and black targets which were masked with both white and black masks, and obtained U-shaped type B masking functions for all combinations, for a contour discrimination task. Becker and Anstis (2004), however did not find effective masking for an opposite polarity mask for a luminance matching task, probably due to a single and large (100 ms) ISI value they used. Another experiment by Breitmeyer et al. (2008), considered both target size and target-mask contrast polarity and found U-shaped masking functions for both polarity masks, for again a luminance matching task. Here, we used only white targets, with black and white masks for a sufficiently large range of SOA values to obtain masking functions for each polarity condition.

2.2 Experiment: Effect of Contrast Polarity on Metacontrast Masking in Contour Discrimination Judgements

2.2.1 Methods

In order to get masking functions dependent on contrast polarity, we employed a (2x9) repeated-measures design, in which we varied mask contrast polarity (white, black) and stimulus onset asynchrony (SOA: 0, 10, 20, 40, 60, 80, 120, 160,

200 ms) between target and mask. Target and mask were presented at equal durations of 20 ms. We also had a baseline “no-mask” target-only condition where the target was shown without a mask following it.

As shown in figure 2.1, the target was a truncated-disk, and the mask was an annulus forming continuous contour with the target, except for the truncation. The target diameter covered 1.5° of visual angle, with a vertical truncation depth of 0.15° in radial direction, parallel to horizontal plane. The truncation was either on the left or the right side of the target. Masks’ inner and outer diameters were 1.55° and 2.55° , respectively, leading to a target-mask separation of 0.05° . The target and the mask were centered on the vertical meridian, 3° above the fixation target. The fixation target was at the center of the screen and it was in the form of a bull’s eye (Thaler et al., 2013), with 0.6° and 0.2° diameters of outer and inner circles, respectively.

Display background was a uniform grey field with a fixed luminance of 45 cd/m^2 . The target disk was displayed only at a luminance of 80 cd/m^2 yielding to a white target. However, the mask was either 10 cd/m^2 (black) or 80 cd/m^2 (white) for opposite and same polarity conditions, respectively, with equal Weber contrasts (Breitmeyer et al, 2008). The fixation target was red with a luminance equal to that of the background.

The task was 2-alternative symmetric forced choice detection task: subjects were asked to decide on the side of the truncation on the target, which was presented on the left or the right side randomly, and equally distributed for each condition. The order of conditions was randomized, and for each condition 20 trials were presented. Performance on each condition was measured as percent correct detections. Response times were also recorded.

Each trial started with presentation of the fixation target, followed by a pre-stimulus interval of 1000 ms, which was jittered by a random amount selected within $[-150,150]$ ms range. Then, target and mask sequence was shown. A response time of 1000 ms was given for subject to respond following the mask offset, after which fixation target disappeared. The inter-trial interval was 1000 ms and it was also jittered as the pre-stimulus interval (see figures 2.2 and 2.3 for depictions of different conditions). For the “no-mask” condition, only the target was presented and allowed response time was with respect to the target offset. For the other conditions, allowed response time was with respect to mask

offset. Subjects were asked to fixate on the fixation target during the trial, and to respond before the fixation target disappears. If the subject had not responded within the given response period, the trial was repeated later in the session.

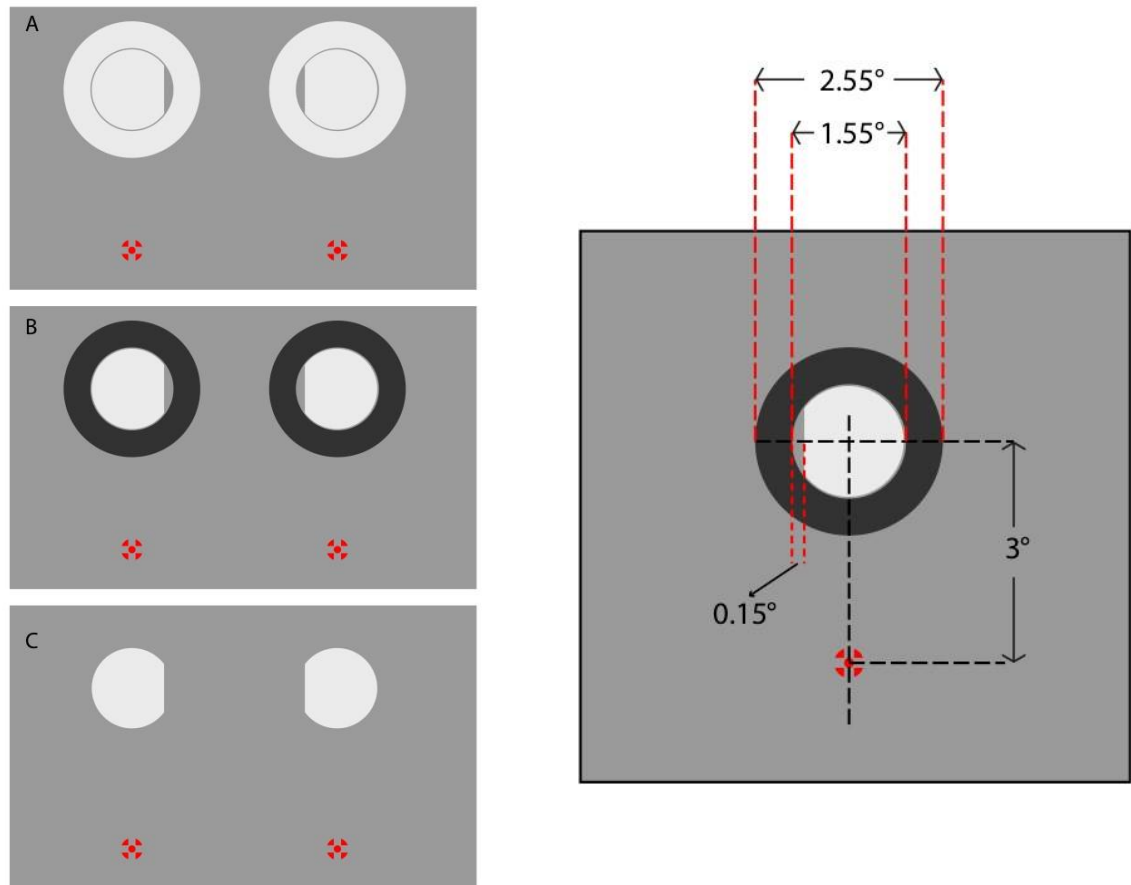

Figure 2.1. Left: stimuli configurations in (A) same-polarity, (B) opposite-polarity, (C) target-only conditions; Right: spatial arrangement, illustrated on an opposite polarity condition, with left-side truncation on target.

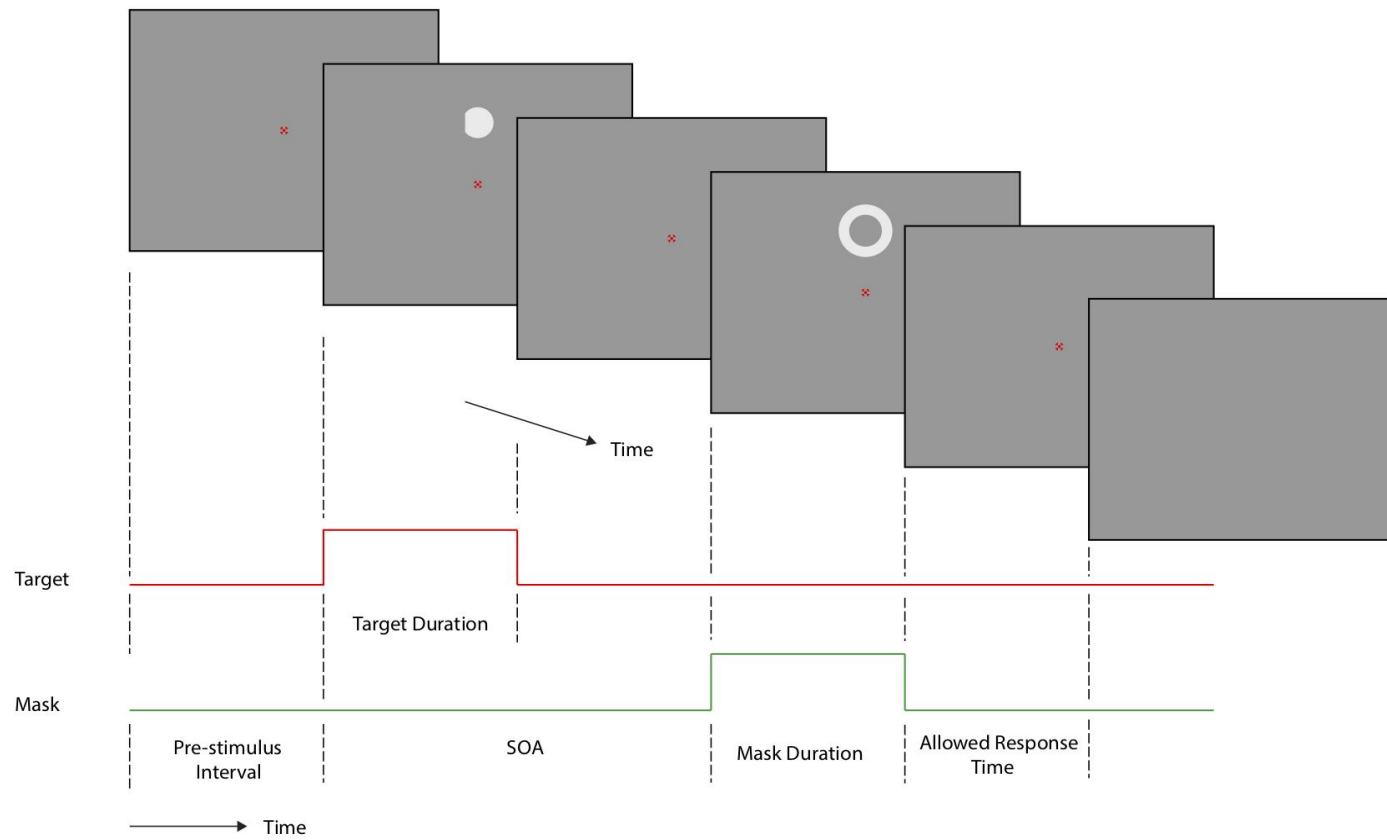

Figure 2.2. Depiction of consecutive frames and timeline in a same-polarity condition trial with $SOA > \text{target duration}$.

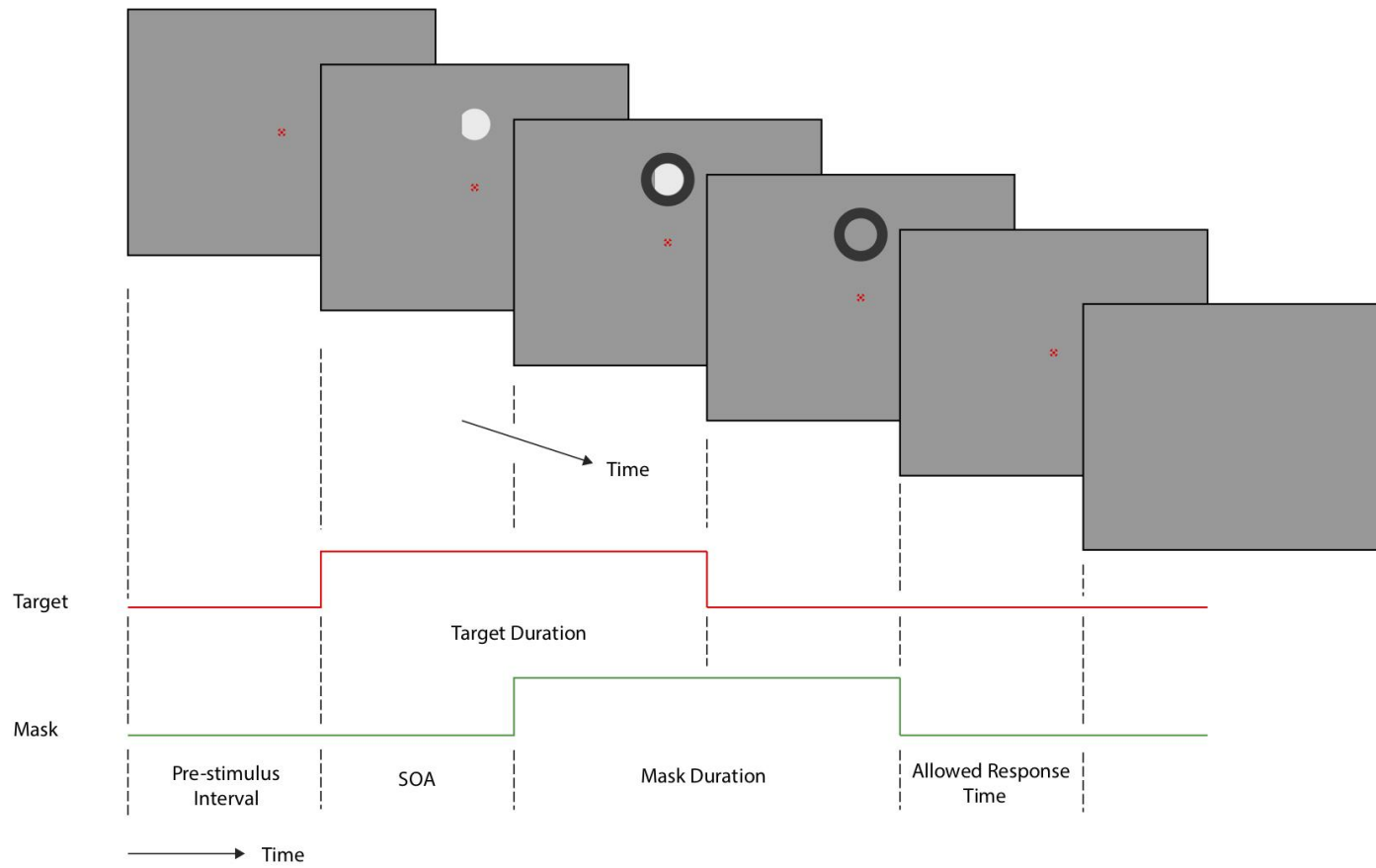

Figure 2.3. Depiction of consecutive frames and timeline in an opposite-polarity condition trial with $SOA < \text{target duration}$.

Some of the aforementioned details of experiment design were due to the main EEG experiment. In order to make the behavioral study similar to EEG experiment as much as possible, we considered some design details beforehand, and designed the behavioral experiment (i.e., prestudy) accordingly. The jitters were used in order to prevent alpha rhythm entrainment to the stimulation rate (Luck,2014), and the inter trial intervals were given for subjects to blink, without contaminating trial data.

The experimental environment was silent and dimly lit. MATLAB version 8.5 (The MathWorks, Natick, MA, USA) together with Psychtoolbox version 3.0 (Brainard, 1997; Pelli, 1997; Kleiner et al, 2007) was used for visual stimuli generation. The stimuli were presented on a 20-inch CRT monitor (1280 × 1024-pixel resolution and 100 Hz refresh rate) at a viewing distance of approximately 57 cm. The monitor was gamma corrected for luminance value to pixel intensity mapping using a SpectroCAL (Cambridge Research Systems, Rochester, Kent, UK) photometer. A digital oscilloscope (Rigol DS 10204B, GmbH, Puchheim, Germany) was used to check for timing of visual stimuli together with a photodiode. Behavioral responses were recorded via keyboard arrow keys.

Twenty-seven observers (age range: 20-32) participated in the behavioral experiment. All observers had normal or corrected-to-normal visual acuity. Participants gave informed consent, and experimental procedure was approved by the local ethics committee at Bilkent University. Each subject was first asked to fill-in the consent and pre-screening forms. Then, the stimuli were introduced by showing all possible target-mask configurations, first in a stationary manner for explanation of the task, then in their normal durations and SOA's. Some target-only conditions were also presented. The subject was informed about the time to respond, that is before fixation target disappears, and importance of fixation was emphasized. Some trials were shown to the subjects to instruct the task and provide examples of visual stimulation. Experiment started when each subject was comfortable with the task.

2.2.2 Behavioral Data Analysis

The amount of metacontrast masking for different conditions were quantified by percent correct (pc) detections of the side of truncation on the target. Further, due to the inverse relation between masking and detection, (1-pc) was used as masking measure. Regarding 1-alternative symmetric forced choice design,

chance level was 50%. In addition, due to possible individual differences, performance on no-mask condition was used as a baseline for each individual subject, and masking functions were analyzed after normalizing to this baseline. A percent correct threshold was defined at 75% for no-mask condition, such that a subject was included in the analysis only if they had performed above this threshold. Further, each subject's masking functions were screened for ceiling and floor effects. A ceiling effect was called when the performance on the task is continually high, such that there is no masking regardless of SOA, and a floor effect was called when the performance was continually low, such that target was always highly masked, regardless of SOA. Among 27 subjects participating to the experiment, 19 of them performed above performance threshold, and no ceiling or floor effects were observed in the masking functions.

2.2.3 Results and Discussion

Averaging for 19 subjects for each condition, resulting masking functions are given in figure 2.4. Considering statistical significance, a 2 (contrast polarity) \times 9 (SOA) repeated-measures ANOVA resulted in the following significant results. The main effect of SOA ($F(8,144) = 10.69, p < .001$), and the main effect of polarity was highly significant ($F(1,18) = 81.67, p < .001$). Furthermore, two-way interaction between SOA and polarity was also significant ($F(8,144) = 26.74, p < .001$).

Individual differences in metacontrast masking have been previously considered. It has been shown that there could be different types of observers, for which different types of masking functions were obtained in the same experiment. In their study, Albrecht et al. (2010) conducted metacontrast masking experiments and applied clustering methods on behavioral data. They obtained two clusters of participants in a single experiment, namely the ones for which type A, and type B masking functions were obtained. Moreover, they summarized the performance measures across the trials of each quarter of a session, and found that the differences in the mean masking functions were enhanced, and considered this result as an indication of perceptual learning during a single session in an experiment. Further analysis regarding sensitivity and response bias also revealed different types of observers (Albrecht & Mattler, 2012). Such differences raised considerations regarding nomothetic and idiographic approaches on perceptual awareness research, suggesting careful use of masking functions in theorizing about the underlying universal

mechanisms (Bachmann, 2010). With respect to aforementioned considerations on individual differences, behavioral data were further analyzed.

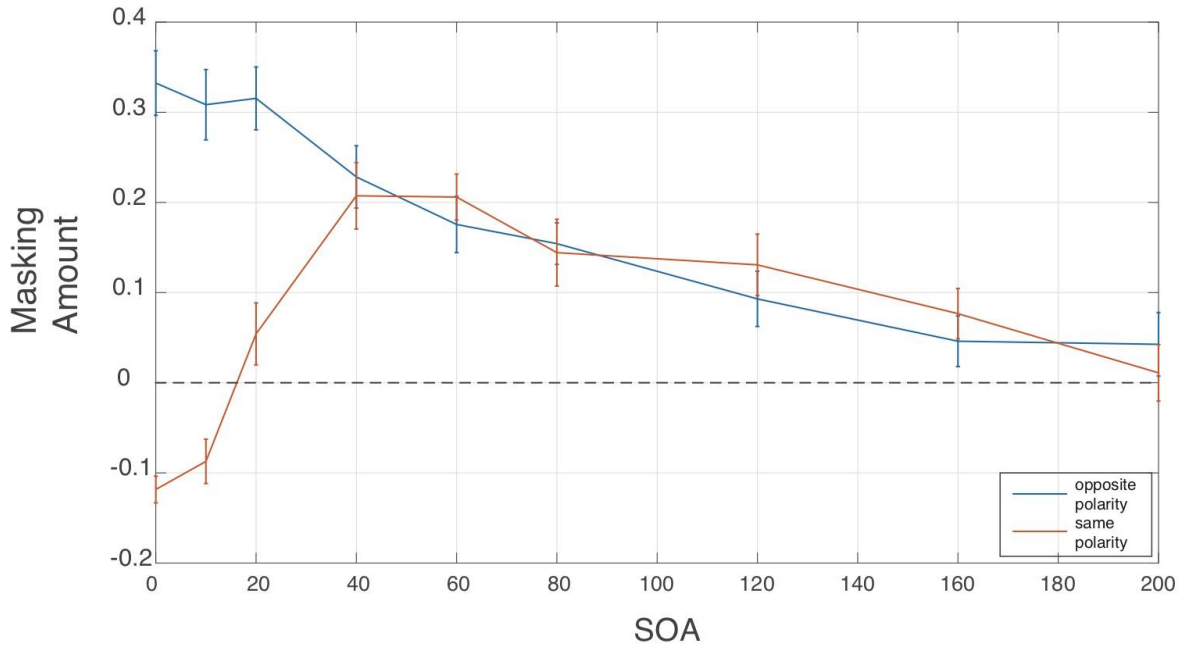

Figure 2.4. Resulting mean masking functions. Type A for opposite; type B for same polarity conditions. Error bars correspond to standard error of the mean.

The symmetric 2-alternative forced choice detection task employed in our experiment was a simple task, when compared to the tasks in the aforementioned studies. In addition, a change in the criterion content in contour detection due to a difference in mask polarity was not expected. Therefore, a zero-bias assumption was reasonable within the experiment. However, behavioral data is analyzed in terms of signal detection theory regarding d' and criterion C to further validate this assumption. Such that if there is no bias, quantified by a $C=0$, then percent correct can be considered as a valid measure of performance (Kingdom & Prins, 2010).

In the analysis regarding d' and criterion C , the proportion of “left” reports to a left-truncated targets was defined as hits, and the proportion of “left” reports to a right-truncated target was defined as false alarms, such that positive response bias would indicate participants’ tendency to respond as “left”, whereas negative response bias would indicate a tendency to respond as “right”. In calculations, extreme values of hit and false alarm rates were corrected using the log-linear approach (Hautus, 1995). Resulting d' and criterion C values validates

use of percent correct as a measure of performance. Such that d' values follow nearly identical masking curves, and criterion C 's are very low. Mean response bias values are provided in figure 2.5, and an interesting finding, as shown in figure 2.6, is a subject's bias in responding as "left", especially under opposite polarity conditions, and under same polarity condition at an SOA for which masking is maximal. Note that the no-mask condition performance of the subject is very low. Masking functions with sensitivity measures are provided in figure 2.7.

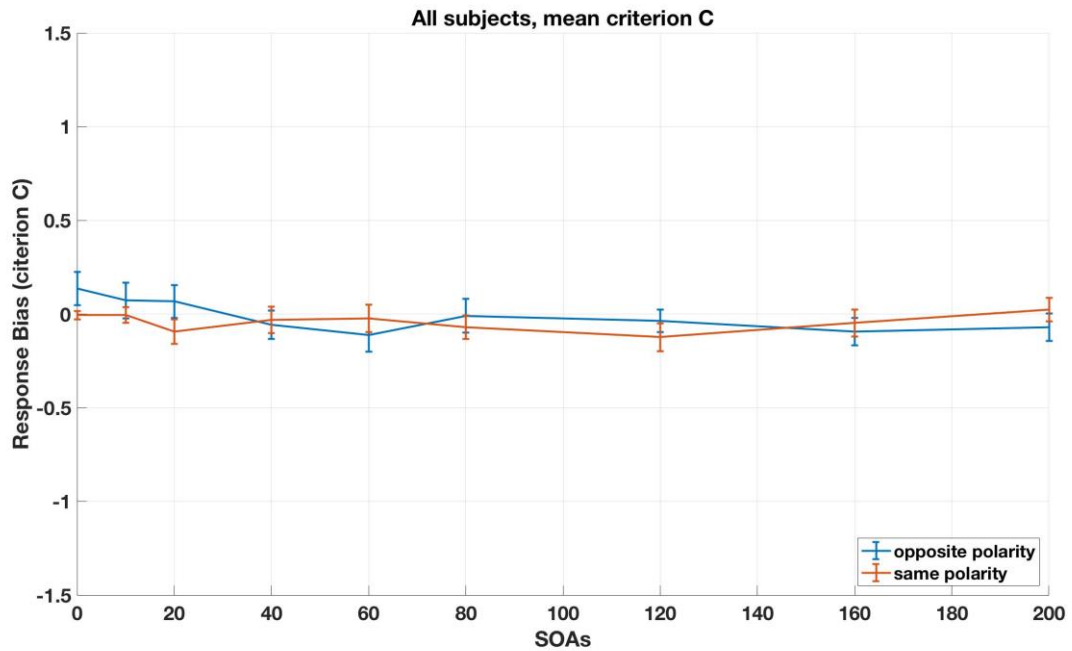

Figure 2.5. Small response bias for both polarity conditions.

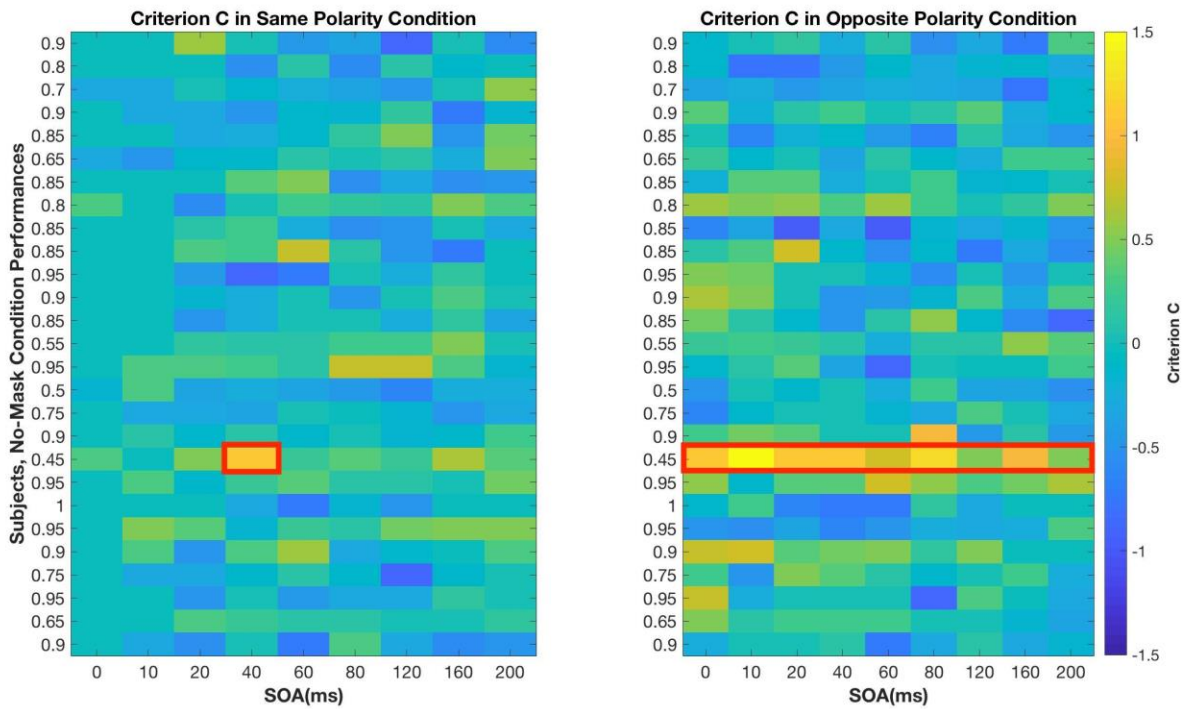

Figure 2.6. Variation of criterion C in different polarity conditions and SOA's, among all participants.

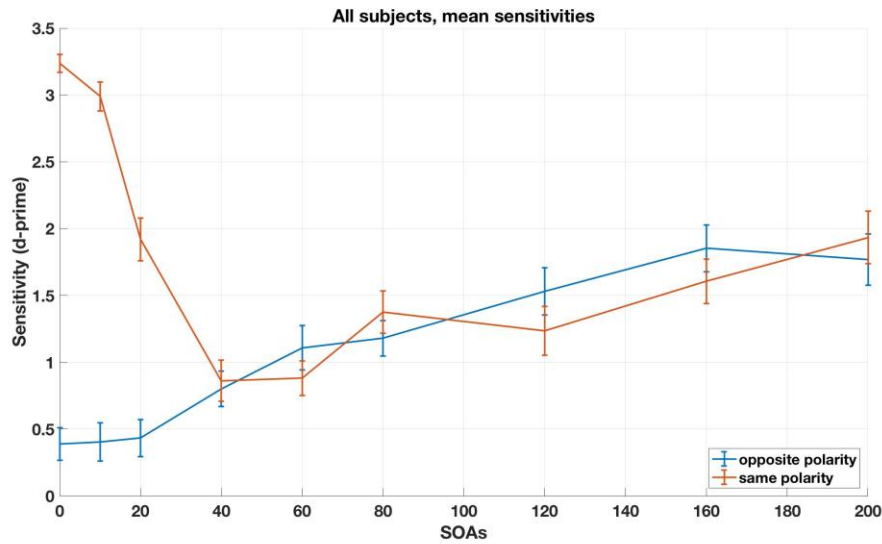

Figure 2.7. Sensitivity curves are nearly identical with masking functions using percent correct (except for inverse shape).

We were not able to analyze the effect of perceptual learning within the session, because experiment was not designed in blocks containing equal number of trials. Rather, conditions were randomized within the whole session. Further analysis considered response times. Results suggest that there is a direct relation between response time and masking amount, such that similar curves to masking functions are obtained (figure 2.8).

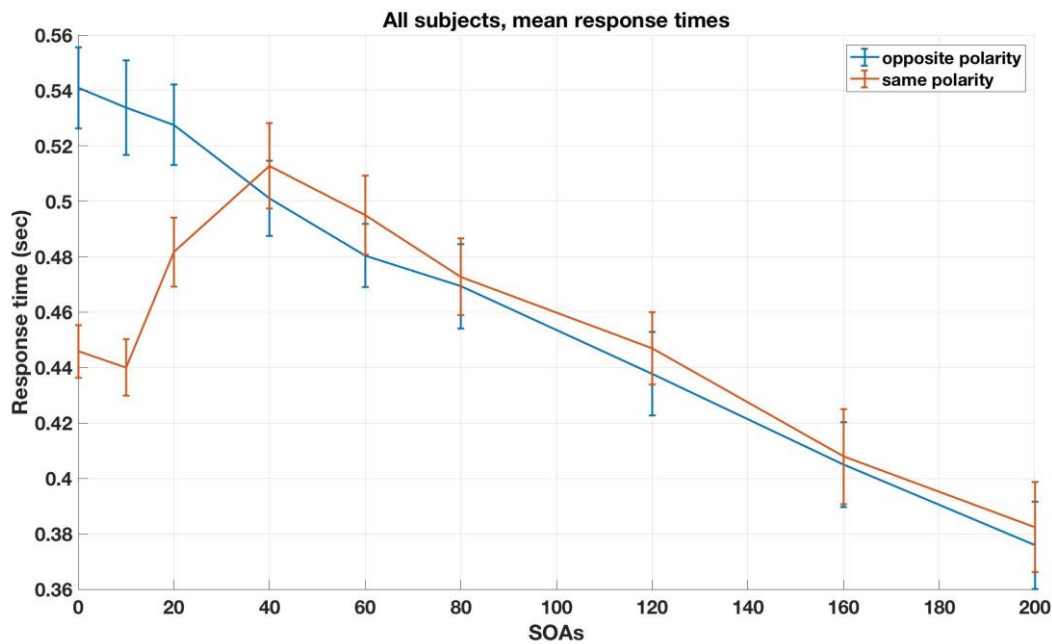

Figure 2.8. Mean response time curves, similar shapes with masking functions.

In addition to these analysis, performance curves of the subjects were analyzed within two contrast polarity conditions. Agglomerative hierarchical clustering with Ward's linkage method resulted in 2 clusters for each condition. The clusters were similar regarding their shapes, and main difference was on performance, especially for higher SOA values (figure 2.9). This result, together with previous analysis, suggests that Type A and Type B distinction in the masking functions were robust across all participants, such that our dependence on masking functions regarding theoretical generalizations are not confounded by large individual differences.

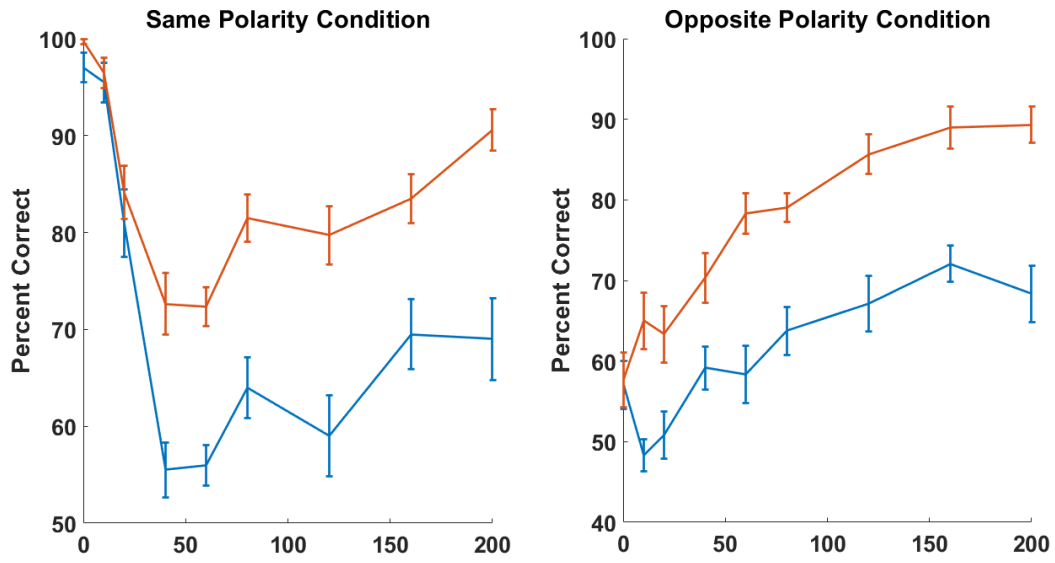

Figure 2.9. Mean performance curves of 2 clusters within each polarity condition. Type A-B difference is preserved.

CHAPTER 3

3 ELECTROPHYSIOLOGICAL CORRELATES OF CHANGES IN META-CONTRAST MASKING SPECIFIC TO STIMULUS CONTRAST POLARITY

3.1 Introduction

Visual masking has also been subject to EEG studies. An early study by Schiller and Chorover (1966) investigated the visual evoked potential (VEP) correlates of perceived brightness under metacontrast masking paradigm. However, they concluded that the evoked potentials correlated with stimulus intensity, not with perceived brightness. Following studies, however, reported ERP attenuation at a target-mask ISI of 40 ms (Andreassi, 1984). Further studies considered specific VEP peaks and latencies, and they found attenuation under metacontrast masking for some late components occurring around 200 ms (Vaughan & Silverstein, 1968) while early components such as C1 and C2 remained unchanged (Jeffreys & Musselwhite, 1986).

Apart from investigations of masking-specific evoked potentials, recent research has also focused on masking paradigm's power of making a visual stimulus selectively visible or not, and attribute differences in neural activations specific to conscious and unconscious processes in vision (Koivisto & Revonsuo, 2010). Previous studies have also explored the relationship between specific oscillatory activities and visual awareness, such that stimulus-elicited metacontrast related cortical activation was suggested to be modulated by the pre-stimulus alpha phase (Mathewson et al., 2009). Moreover, other studies suggested that visual masking can disrupt feedback mechanisms in visual cortex (Fahrenfort et al., 2007).

In the light of previous research regarding metacontrast masking, in this thesis we aimed to provide neurophysiological evidence for both contrast polarity arrangements of a target and mask pair. Such that similar response profiles may suggest equal effectiveness of either same or opposite contrast polarities.

3.2 Methods

Considering Type-A and Type-B masking functions obtained in the previous experiment, three critical SOA values were selected for further investigation of the electrophysiological correlates of masking under 2 (contrast polarity) \times 3 (SOA) conditions. SOA values were selected as 10ms, in which target contour is highly masked for opposite polarity mask, and highly visible for same polarity mask; 50ms, where maximum masking occurs for the U-shaped Type-B function under same polarity condition, and intermediate masking for Type-A function under opposite polarity condition; and 200ms where target contour is highly visible for both contrast polarity conditions. The EEG experiment was identical to the previous behavioral investigation, except for the selection of these SOA values. In addition, trial numbers were increased to 60 for each condition in the EEG experiment as opposed to 20 in behavioral one.

In isolating brain activation specific to the effect under investigation, previous studies used the ERP differences between conditions. Specifically, studies using multi-modal stimulation for detecting interactions between senses widely employed difference waves. For example, in a study regarding sound induced flash fusion (Mishra et al., 2008), neural activity associated with fusion effect is obtained by subtracting the activation due to auditory-only (A) and visual-only (V) from the activation due to bimodal audiovisual (AV) presentation. In obtaining activation due to the effect as $AV-(A+V)$, activation due to cognitive processes which are not specific to stimulation, such as expectancy manifested as contingent negative variation (CNV) components of ERPs, is subtracted twice. Thus the no-stimulus (NS) activation is added to the AV activation in order to balance for this sort of activity. Finally, they quantified the neural activity associated with sound induced flash fusion as $[AV+NS]-[A+V]$. Another balancing method for such multiple subtraction of common activity is employing tactile (T) stimuli together with auditory, visual and audiovisual and obtain effect-specific activity as $[T+TAV]-[TA+TV]$ (Gondan & Röder, 2006). Subtraction methods are also used in studies of masking. In their study,

Fahrenfort et al. (2007) used subtraction method to obtain masking-specific activity.

Regarding previous considerations in isolating activity specific to the process of interest, we included a secondary session in the EEG experiment, in which subjects were not required to respond to the stimuli. In this session either a black or a white mask, identical to the masks used in the other session, were presented without a preceding target. Further, in order to balance for multiple subtraction effects, a no-stimulus (NS) condition was also included. Trial numbers were equal to the ones on the other session, that is 60 for each condition. Temporal arrangement in terms of ITI and pre-stimulus interval and their jitters were also the same. Aim of this design was to isolate activity due to masking by subtracting the activity due to mask-only (M) and target-only (T) conditions from target+mask (TM) presentation, by shifting the mask only activation regarding the SOA values, while balancing the twice subtraction by adding the NS activity. Such that Masking Effect = $[TM+NS]-[T+M]$.

EEG experiment was conducted in the same environment with the same apparatus in the behavioral experiment. A 64-channel system (Brain Products, GmbH, Gilching, Germany) was used for EEG recordings. Elastic EEG caps (BrainCap MR, Brain Products, GmbH) were used, which included 63 sintered Ag/AgCl passive electrodes, arranged according to international 10/20 system. An electrode was placed on the back of the subjects for electrocardiogram (ECG) recordings. Two scalp electrodes were reference (FCz) and ground electrodes (AFz). Electrode impedances were kept below 10 k Ω by applying a conductive paste (ABRALYT 2000, FMS, Herrsching-Breitbrunn, Germany), via syringe and q-tips. BrainVision Recorder Software (Brain Products, GmbH) was used to record the data and store event markers, which were again calibrated by a digital oscilloscope (Rigol DS 10204B, GmbH, Puchheim, Germany). EEG signals were sampled at a 1 kHz sampling rate.

Among 19 observers from the previous experiment 14 observers (age range: 21-32) participated in the EEG experiment, which had normal vision and no history of neurological disorders.

3.3 Data Analysis and Results

As a first step, behavioral data was analyzed to check if type A and type B masking functions were preserved with selected SOA values in EEG experiment. In order to quantify masking, similar to previous experiment, percent correct (pc) responses at each condition were subtracted from one (1-pc), and normalized by baseline performance on target-only condition. Mean masking functions are plotted in figure 3.1, which shows that EEG experiment behavioral data has not changed with respect to previous experiment. Furthermore, response times were analyzed and similar type A and type B functions were observed, continuous with the previous experiment (figure 3.2). The response times are also important when analyzing EEG data.

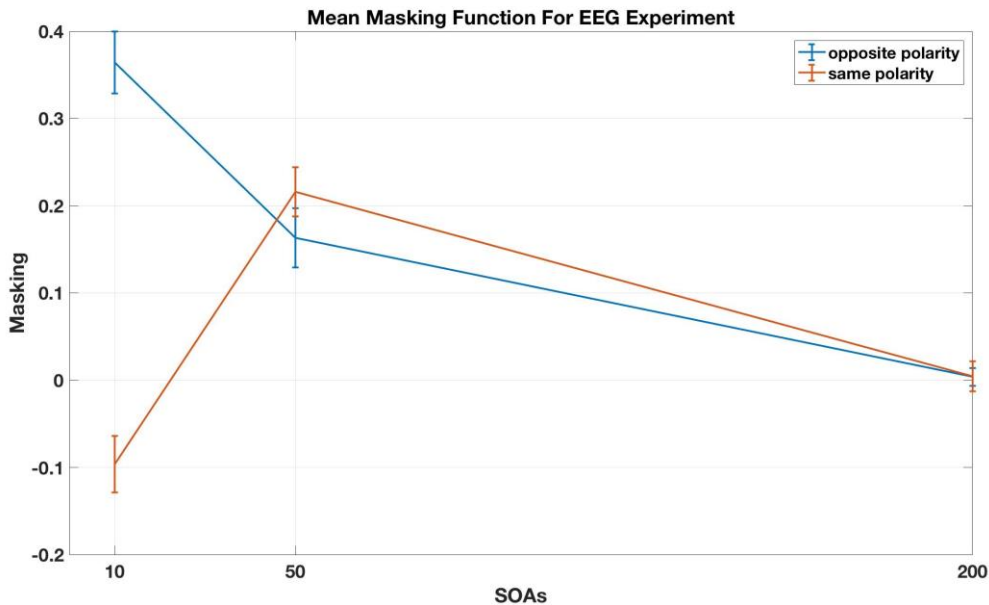

Figure 3.1. Masking functions in EEG experiment.

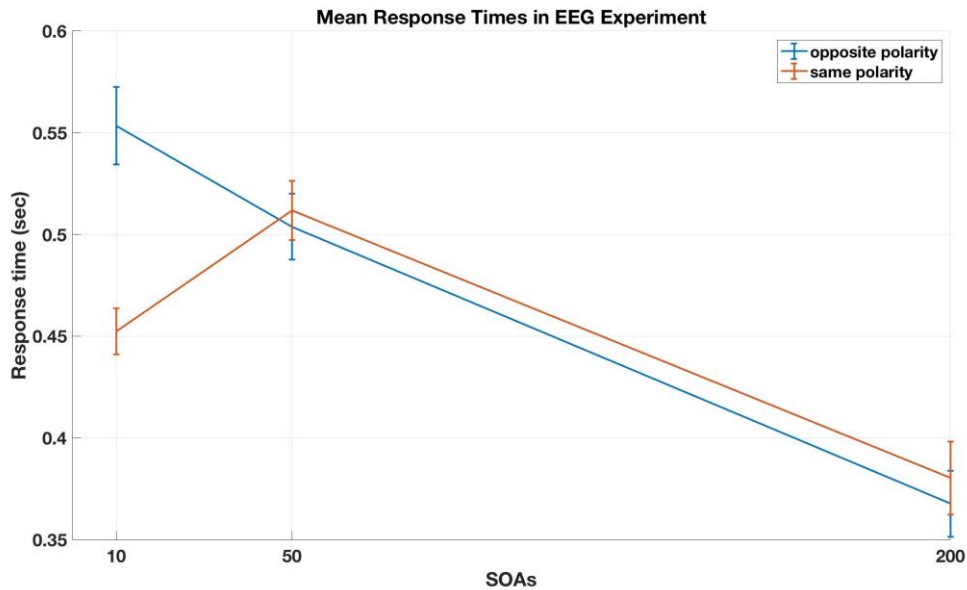

Figure 3.2. Response times in different conditions in EEG experiment.

EEG data was analyzed with Brainstorm (Tadel et al. 2011) toolbox within MATLAB (The MathWorks, Natick, MA, USA). In preprocessing, large unused segments such as session breaks were removed. Then, the data was downsampled to 500 Hz. Power spectrum density was monitored for rejection of significantly noisy channels. Scalp topographies at certain frequencies were checked for consistency, such as high power at occipital sites for alpha range (~10 Hz) and eye movements at smaller frequencies (~1.5 Hz) at frontal sites. The data were offline rereferenced to a common average reference and a notch filter at 50 Hz was applied for power-line contaminations. Then a zero phase shift band-pass filter was applied at 0.5 Hz and 70 Hz cutoff frequencies. Noisy electrodes were interpolated with its neighboring electrodes. Then eye blinks were detected using the activity at frontal electrodes and artifact correction was applied using independent component analysis (ICA) method. The data is divided into epochs regarding trials and stimulus onset events centered at zero, within a [-600,1200] ms window. Trials were screened manually for undetected artifacts. On average 95% of the trials were preserved. Trials were averaged within conditions and baseline corrected by subtracting the mean [-100,0] ms with respect to stimulus onset. A low pass filter at 40 Hz cut-off frequency was applied to further smooth the ERPs. In order to obtain the difference waves for each subject, the ERPs are computed for target-only (T), mask-only (M) (for

white and black masks separately), and no-stimulus (NS) conditions. Mask-only conditions were shifted in time, regarding the SOA value in order to subtract from ERP of TM presentation. Masking-specific activation patterns are obtained by [TM+NS]-[T+M] computations, and low-pass filtered once again for smoothing the abrupt jumps in data caused by subtraction.

Firstly, to investigate the differences in evoked activity due to a change in mask luminance, white (same polarity in TM condition) and black (opposite polarity in TM condition) mask-only conditions were compared. An early difference, within [52,84] ms interval was found (see Appendix A.3).

Secondly, as indicated by the behavioral data, contrast polarity of the mask did not make a difference in the amount of masking at 50 and 200 ms of SOAs. However, within each polarity condition, the target was masked at 50 ms SOA, and unmasked at 200 ms of SOA, by a similar amount regardless of contrast polarity. To further analyze EEG data, running paired t-tests were used to compare a pair of SOA (10 ms and 50 ms; 10 ms and 200 ms; 50 ms and 200 ms) conditions within each contrast polarity condition. Paired t-test results for SOA conditions' comparison are given in Appendix A.2.

In order to detect differences in ERPs due to different contrast polarity conditions, pointwise running paired t-tests (Kaya et al., 2017) were conducted both on difference waves ([TM+NS]-[T+M]) and mask-only conditions (figure 3.3). Moreover, for each time point and EEG channel, repeated measures two-way ANOVAs (figure 3.4) were computed with SOA (10, 50, 200 ms) and contrast polarity (same, opposite) as factors, on difference waves.

The difference in masking functions were maximal at 10 ms of SOA for different contrast polarity conditions, as indicated by behavioral analysis. Consistent with this finding, significant differences in ERPs due to a difference in mask polarity was more widespread in time, at 10 ms of SOA, as shown by the t-tests in figure 3.3, and ANOVA contrast polarity main effect in figure 3.4. Regarding these results, three time windows of interest are selected as [160-260] ms, [280-360] ms, and [380-500] ms. Averaging within these time windows, topographical activation patterns are also plotted in figure 3.5 for an overview, and detailed plots are provided in Appendix A.4. Moreover, representative electrodes are selected for ERP analysis. ERPs are compared for all SOA conditions for an occipital cluster (O1, O2, Oz) in figure 3.5. Furthermore, a parietal cluster (P1, P2, Pz) is selected for SOA = 10 ms; a left parieto-occipital (P5, P7, PO7) cluster is

selected for SOA = 50 ms; and a central cluster (Cz, C1, C2) is selected for SOA = 200 ms conditions, and plotted in figure 3.6. In selecting SOA-specific clusters, we considered the t-test results and the regions where significant difference in difference waves due to contrast polarity were found, for each SOA condition.

Comparison of Different Mask Polarity Conditions at Specific SOA Values Using Difference Waves

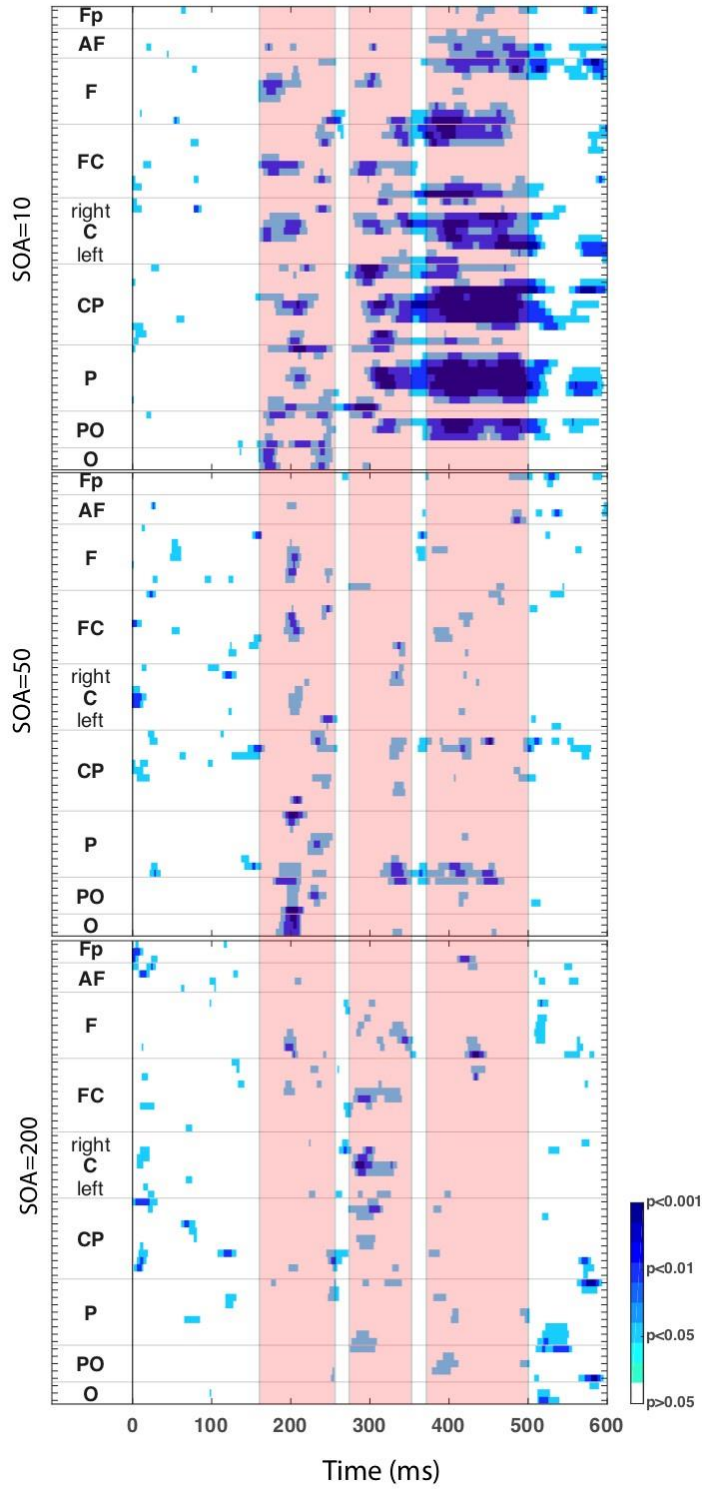

Figure 3.3. T-test results for comparisons between contrast polarities.

ANOVA Results on Difference Waves
with SOA and Contrast Polarity as Factors

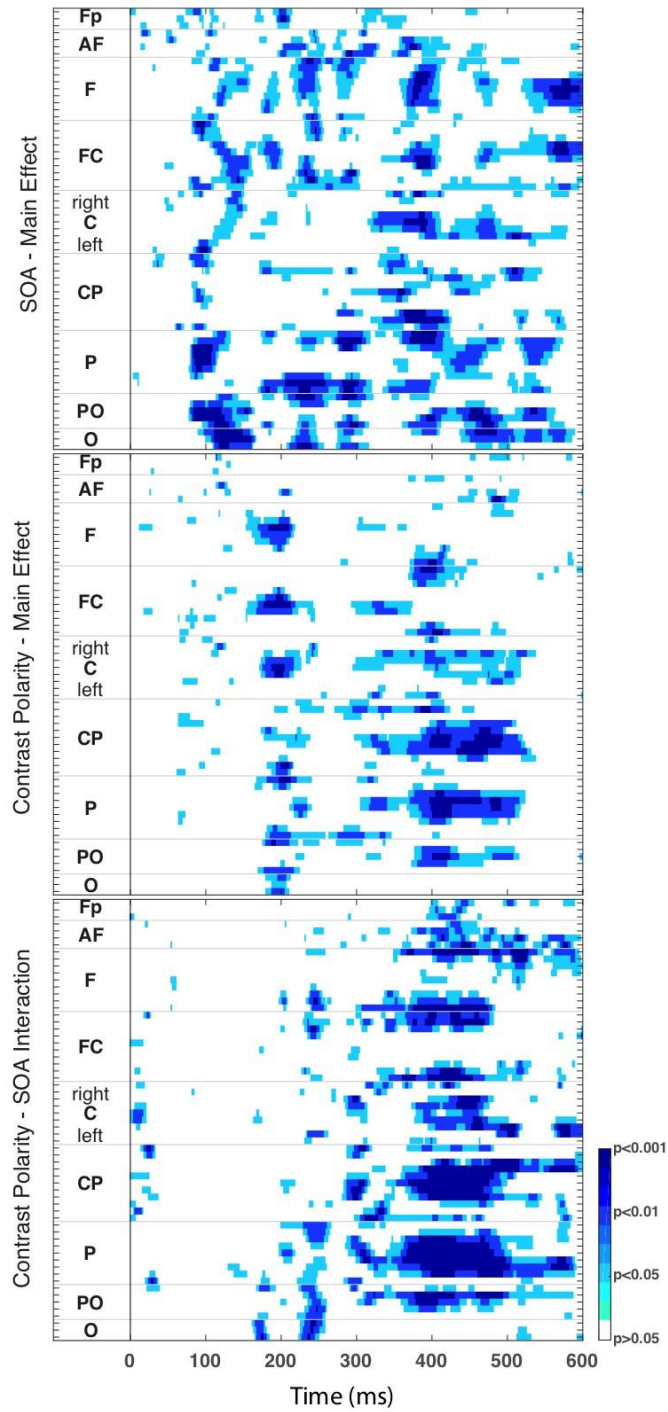

Figure 3.4. Repeated measures ANOVA results for contrast polarity and SOA as factors.

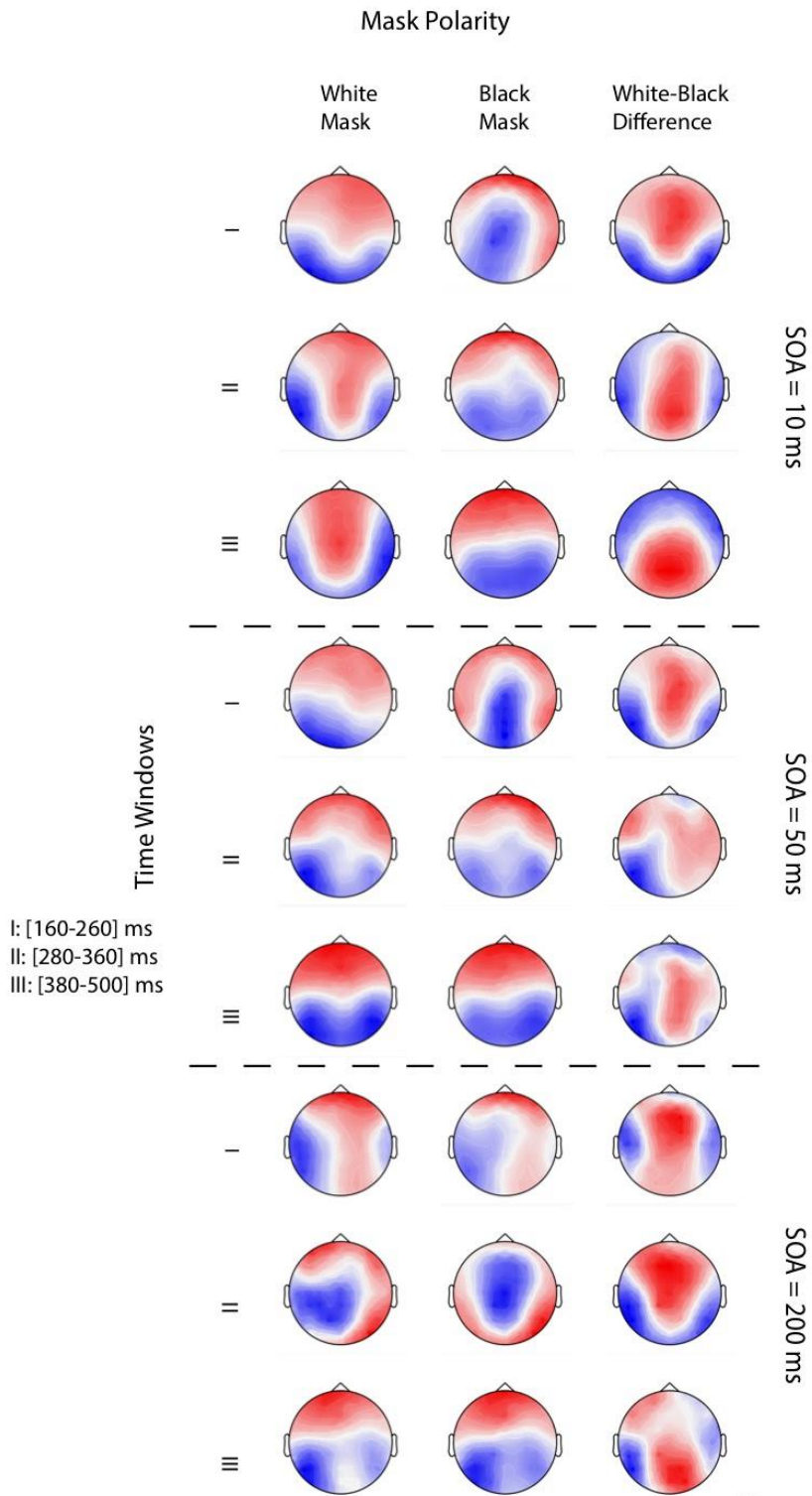

Figure 3.5. Topographies for all SOA conditions at selected time windows, and difference of mask polarity conditions.

Occipital (O1, O2, Oz) Electrode Cluster Average on Difference Waves ($[TM+NS]-[T+M]$)

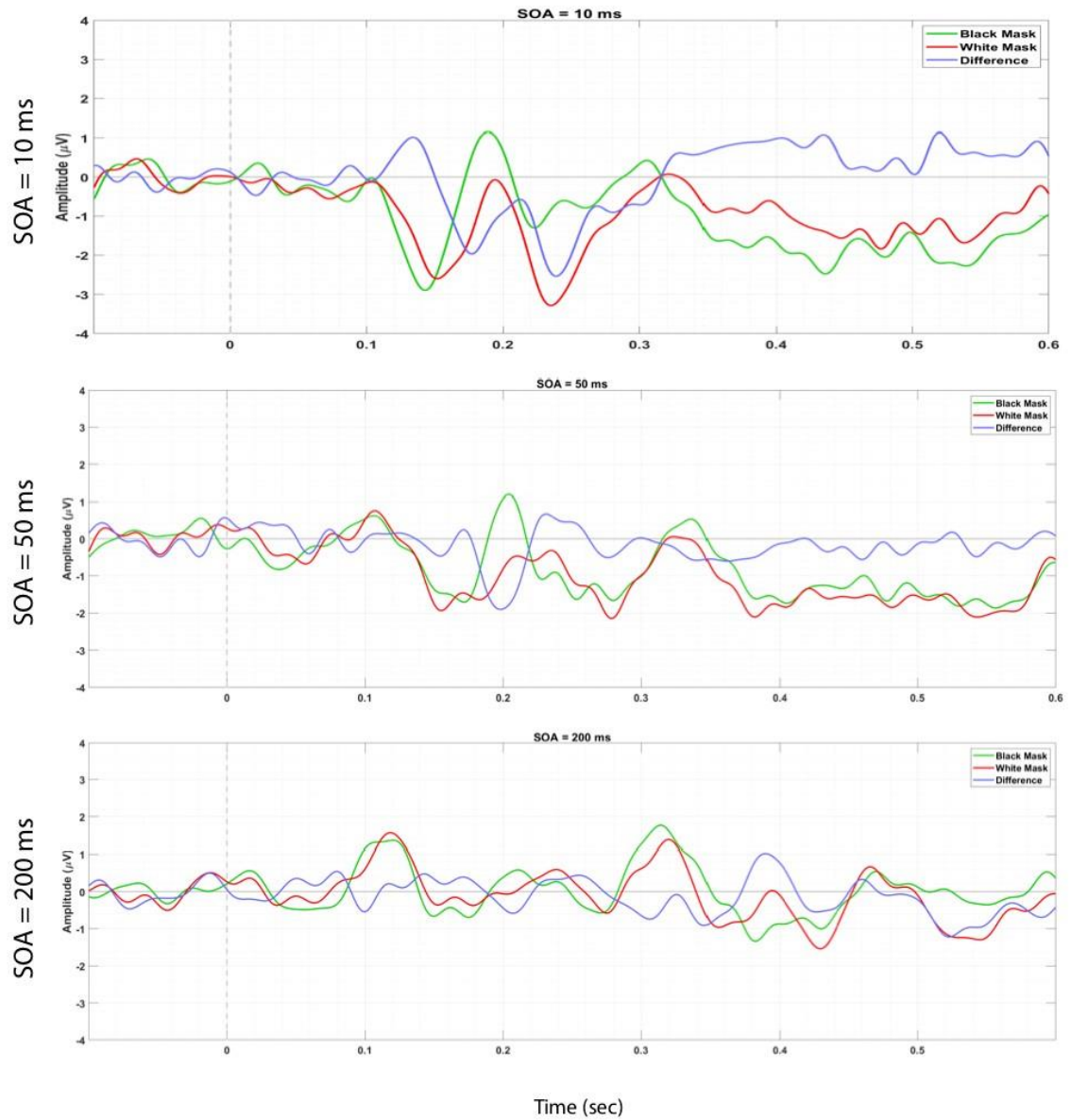

Figure 3.6. Difference waves for each polarity condition and their difference (white-black), within each SOA condition, for the occipital electrode cluster (O1, O2, Oz).

SOA-Specific Clusters' Averages on Difference Waves ([TM+NS]-[T+M])

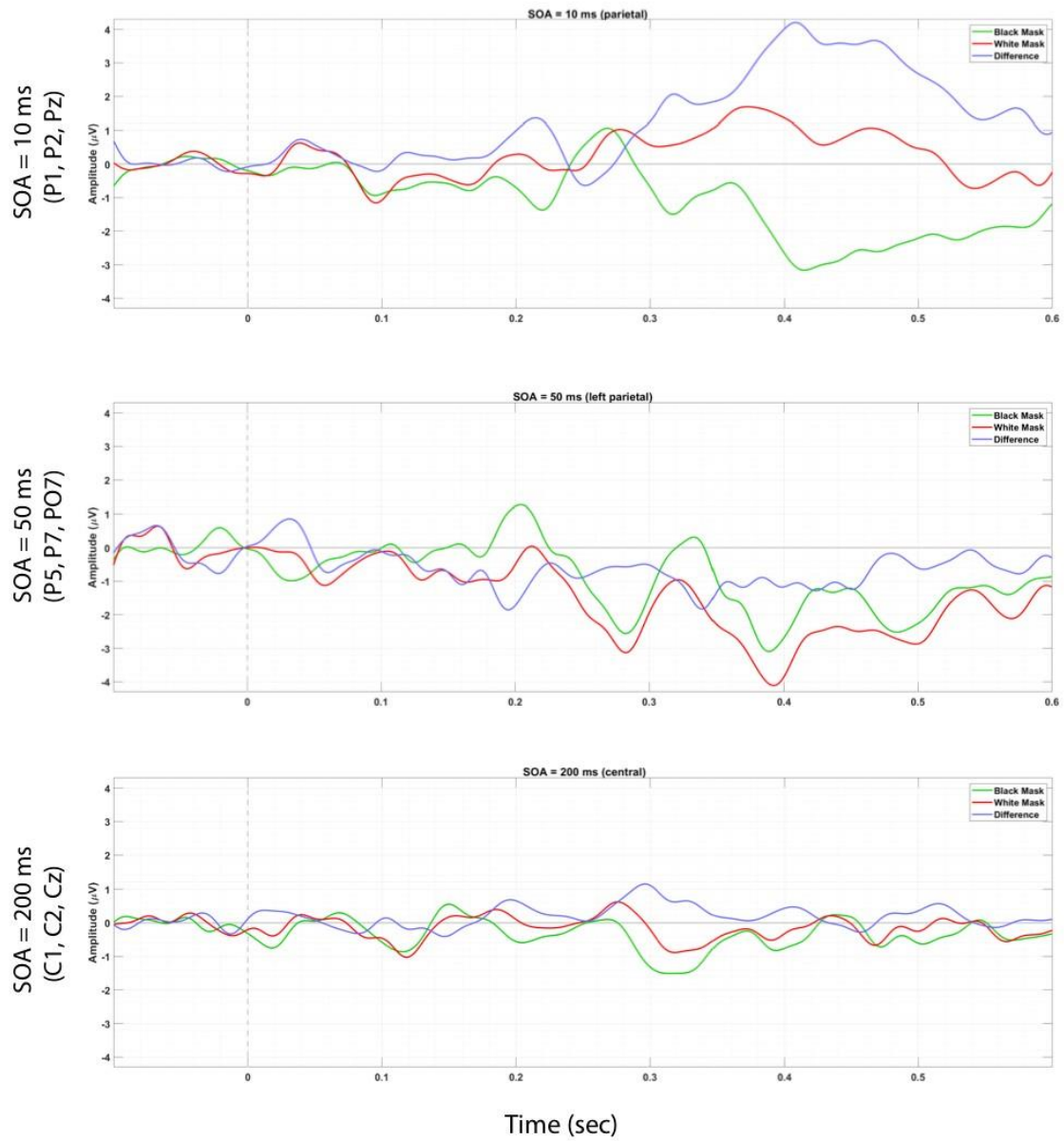

Figure 3.7. Difference waves for each polarity condition and their difference (white-black), within each SOA condition, for SOA-specific electrode clusters: parietal (P1, P2, Pz) at 10 ms; left-parieto occipital (P5, P7, PO7) at 50 ms; and central (C1, C2, Cz) at 200 ms.

CHAPTER 4

4 GENERAL DISCUSSION

4.1 Discussion on Behavioral Prestudy Experiment

In a previous study, Breitmeyer (1978) found type B masking functions for both the same and opposite contrast polarities of target-mask pairs, as an evidence for inter-channel inhibition regarding the mechanism underlying masking phenomena. In the behavioral investigation of this thesis, type A and type B masking functions were obtained for the same and opposite polarity conditions, respectively. The experimental design of Breitmeyer (1978) seems to be nearly the same with the current one, however there are substantial differences which may account for such differences in masking functions. Breitmeyer (1978) used similar truncated disks as targets and concentric rings as masks, however spatial arrangement was significantly different: foveal eccentricity was 1.4° compared to 3° in this experiment; and target-mask pairs were also smaller. Also the durations were shorter (10 ms). Furthermore, Breitmeyer (1978) employed symmetric stimuli (target-mask pairs) on the left and right visual fields: one with, the other without a truncation, and asked the subjects to indicate the side on which the truncation was present. However, in our behavioral experiment there was a single target-mask pair, which might make the task harder since there were not any reference stimuli to compare. Another study (Becker & Anstis, 2004) uses a single ISI value of 100 ms with disk-ring metacontrast arrangements and fails to find masking for opposite polarity masks, concluding that “metacontrast masking occurs within, but not between separate visual ON and OFF pathways”. However, as pointed out by Breitmeyer et al. (2008) use of a single and large asynchrony (SOA or ISI) between target-mask pairs might result in missing the optimal temporal discrepancy that would mask the target. Apart from slight differences in masking functions due to experimental designs, it has been shown by this and other studies (Breitmeyer, 1978; Breitmeyer et al.,

2008) that an opposite polarity mask, activating the OFF pathway still can inhibit the target mediated (ON pathway) activation.

Two main accounts of type A and type B masking functions obtained in our behavioral study are integration and interruption. For the same polarity mask, the performance increases at short SOAs suggesting facilitation, whereas maximum masking for opposite polarity at short SOAs suggests integration. An account of facilitation, that is performance increase in short SOA values for the same polarity condition might be due to within-channel lateral inhibition at low levels. It is suggested that lateral inhibition in the retina typically extends over only a small fraction of a degree of visual angle (Palmer, 1999) and the size of truncation is small (0.15°) in our experiment. Such that an OFF cell, whose receptive field is centered at the truncation site might receive more input from its surround and increase its firing rate when compared to less input in the opposite polarity mask condition. On the other hand, it is suggested that integration masking occurs when the target and mask are perceived as part of the same pattern due to imprecise temporal resolution of the visual system (Enns & Di Lollo, 2000), which might be the case for small SOA values. Moreover, it is also suggested by Enns & Di Lollo (2000) that integration masking increases with the luminance contrast of the mask, and contrast has almost no effect on interruption masking. Our findings are in accordance with these theories. At the same polarity, target-mask contrast is the same, and facilitation occurs at short SOAs (0 ms, 10 ms). However, for the opposite polarity mask, the contrast is higher and masking is increased. In addition, at intermediate SOAs (40 ms, 60 ms), where interruption is suggested to be the active mechanism, contrast polarity of the mask does not make any difference on the amount of masking, which is an implication for transient-OFF activity mediated by the mask inhibiting the sustained-ON activity due to the preceding target. Furthermore, at an SOA = 0 ms, it would be possible to consider common-onset masking if mask offset was delayed relative to the target. However, target and mask offsets are equal, thus rules out the possibility of common-onset masking. Furthermore, the effect of attention has been studied with 4-dot and object-substitution masking, employing multiple target presentations and requiring attention to be on the target location for absence of masking. In our study, the effect of attention was not manipulated and thus, not theoretically considered.

The behavioral findings of this study are consistent with the sustained-transient dual-channel model of masking (Breitmeyer & Ganz, 1976), and an unclumping of RECOD model (Öğmen, 1993) regarding ON transient and sustained, and OFF transient and sustained channels might be possible (as depicted in figure 4.1). The model relies, as also suggested by Breitmeyer (1978), mainly on the following: (i) the target and the mask both activate the sustained and transient channels which are due to parvocellular and magnocellular pathways, respectively, (ii) both ON and OFF pathways have sustained and transient sub-channels, (iii) sustained channels are activated with a latency of about 20 ms (Schmolesky et al., 1998), (iv) transient channels inhibit sustained ones, and (v)

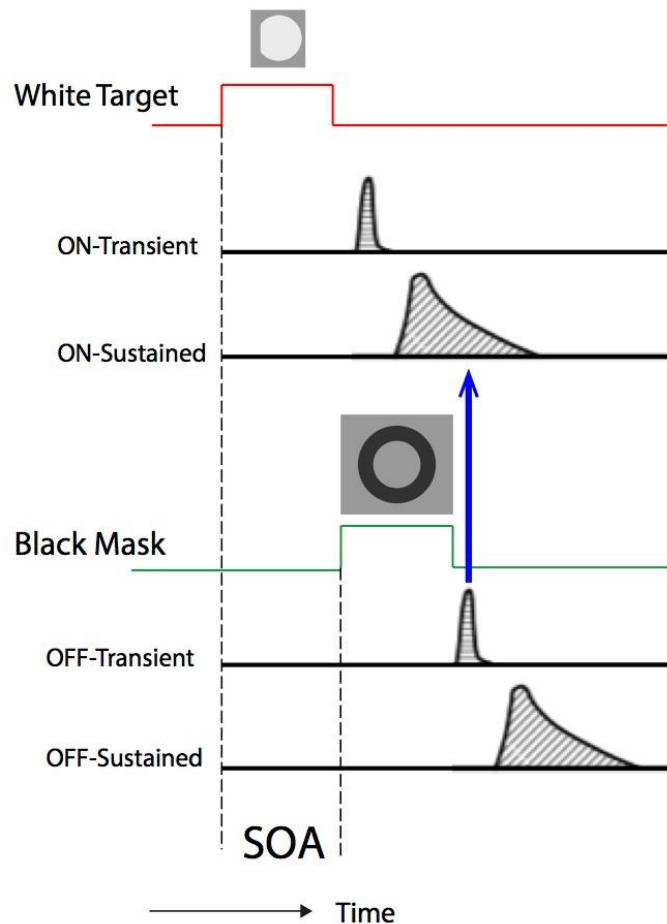

sustained channels are involved in contour detail information.

Figure 4.1. Depiction of inter-channel inhibition at a suitable SOA value. Mask-mediated OFF-transient activity inhibiting target-mediated ON-sustained activity, shown by blue arrow (modified to fit current experiment, from Breitmeyer et al., 2006).

4.2 Discussion on the Main EEG Experiment

EEG data analysis provided similar cortical activation patterns for different contrast polarity conditions, except for the short SOA of 10ms. An analysis of mask-only conditions provided increased peaks as luminance increases, which is supported by previous studies (Schiller & Chorover, 1966). Further investigation of ERPs generated due to different contrast polarity masks at 10ms SOA showed differences in ERPs generally attributed to consciously perceived and not perceived stimuli. Such that an increase in early positivity, visual awareness negativity (VAN), and late positivity (LP) components for visually aware stimuli (Railo et al., 2011). The difference waves ([TM+NS]-[T+M]) were provided for each SOA and polarity condition in Chapter 3, however differences in aforementioned components are more visible when ERPs due to TM are plotted as in the figure 4.2.

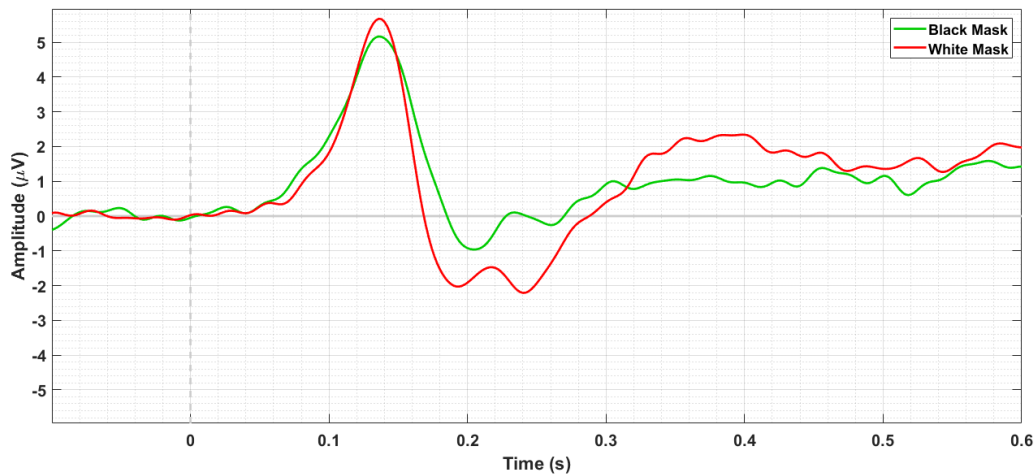

Figure 4.2. ERPs of TM presentation at 10 ms of SOA, average of occipital (O1, O2, Oz) electrodes.

The t-tests in Chapter 3 revealed differences due to mask contrast polarity at each SOA and considering time windows as A: [160-260] ms, B: [280-360] ms, and C: [380-500] ms showed the following: (i) for all time windows, the effect of mask polarity on activation patterns diminished, (ii) for time window A, the difference spread in that time range for 10 ms SOA condition is first saturated at around 200 ms for 50 ms SOA condition, then disappears for 200 ms SOA

condition, (iii) the topographically spread difference at 10 ms of SOA in time windows B and C clusters to a left parietooccipital site at 50 ms of SOA, while for 200 ms of SOA the difference remains at central sites for time window B, and diminishes for window C.

In addition, comparisons of SOAs of 50 ms and 200 ms as masking-present and masking-absent, respectively as presented in Appendix A.2, shows similar differences for both polarity conditions. Especially, the difference in [110-160] ms time window is present for both polarity conditions. It was previously suggested that such difference in posterior occipital generators between masked and unmasked conditions could account for interruption of feedback mechanisms to early visual areas such as V1 (Fahrenfort et al., 2007). Our results show that such difference is more spread in window [110-160] ms for same polarity mask, and saturated at 120 ms, but still present for the opposite polarity mask. This might suggest that the interruption of feedback mechanisms is stronger for the same contrast polarity masks, and opposite polarity masks employ similar mechanism resulting in equal amount of masking in behavioral data at 50 ms of SOA.

In conclusion, this thesis provided empirical evidence on masking phenomena regarding the effects of a change in mask contrast polarity. Firstly, behavioral pre-study provided another evidence on effectivity of opposite polarity mask, specifically for the inter-channel inhibition of ON-sustained activation by both ON- and OFF-transient activation at intermediate SOAs of 40 ms and 60 ms, and provided evidence for the within-channel lateral inhibition at short SOAs such as 0 ms and 10 ms resulting in facilitatory and masking effects for same and opposite polarity masks, respectively. Secondly, EEG experiment provided the changes in cortical activation patterns due to a change in contrast polarity, and showed that a sub-cortical difference at short SOA value of 10 ms can result in large differences in the ERPs since contrast polarity manipulation differentiates stimuli seen and unseen. In addition, a comparison of masked (SOA = 50 ms) and unmasked (SOA = 200 ms) conditions suggests similar cortical mechanisms for both polarity masks.

4.3 Implications for Cognitive Science

From an information processing point of view, formation of a percept has several hierarchical stages. Various schemes are proposed for the stages of

visual processing. A generalized framework, as provided by Palmer (1999), has four stages of visual processing which are the image-based, surface-based, object-based, and category-based processing, if ordered in a bottom-up (data-driven) fashion.

Based on similar assumptions, visual masking research capitalizes on this constructive nature of visual perception for a better understanding of the microgenetic mechanisms and stages of visual processing, especially within the first 250 ms time window in which target-mask interactions suggested to be effective (Bachmann & Francis, 2013). The visibility of the target is quantified by psychophysical measures, and plotted as a function of the temporal separation between the target and the mask onsets. The amount of temporal separation at which maximum amount of masking occurs is critical.

It is possible to base the perceptual judgment on different attributes of the object. Among these attributes, the most prominent distinction is between edge/contour and surface properties which have been extensively studied for theorizing about the early stages in percept formation. A study by Breitmeyer et al. (2006) employs contrast matching and contour discrimination tasks to reveal differences between contour- and brightness-processing mechanisms. The critical SOA values in metacontrast functions turn out to be different: 10-20 ms for contour discrimination task, and 40 ms for contrast matching task. Relying on the assumption that the mask interrupts the processing of the task-related attributes of the target in backward masking, this result suggests that the contour of a stimulus is processed before the surface of it.

In addition, temporally dissociative power of visual masking is not limited to the processing of edge and surface attributes. Previous studies employed masking in order to reveal the temporal order of the processes of interest underlying numerous cognitive phenomena. In shape perception, Wilkinson & Wilson (2006) found that the influences of spatial lateral interactions are maximal around 80-110 ms of temporal asynchrony; in scene gist processing, Loschky & Larson (2010) investigated the order of superordinate and basic-level categorical distinctions and found that superordinate distinctions are more sensitive to masking than basic-level distinctions for short SOA values (less than 72 ms), suggesting a superordinate distinction at early levels of processing preceding the basic-level distinctions; in visual search, Seya & Watanabe (2012) investigated the minimal time required to process visual information using a

gaze-contingent masking method by manipulating the temporal delay between the gaze shift and following mask, and found that subject performances on the task are decreasing for delays shorter than 50 ms, which is suggested to be the “effective acquisition time” during visual search (as cited in Bachmann & Francis, 2013).

The relation between attention and masking is mainly studied under a special case of masking called object substitution masking (OSM). In OSM, the mask is effective if the target is presented among several simultaneously presented similar objects, and ineffective if the target is presented alone (Enns & Di Lollo, 2000). Distribution or misdirection of attention (mainly controlled by the target-set size) delays conscious target identification, however items outside the focus of attention might be sufficient to influence cognitive processes (Enns & Di Lollo, 2000). OSM assumes an interaction between attention and masking, however, it has been suggested by Agaoglu et al. (2016) that although visual masking and attention both control the transfer of information from sensory to short-term memory, reports of interaction between masking and attention are prone to saturation effects such that masking is not effectively changing as a function of temporal asynchrony.

As discussed above, it is possible to employ masking in numerous cognitive phenomena, and use the results as an evidence on theories regarding different aspects of perception. However, although widely studied, masking and its governing principles are not fully understood yet. The experimental manipulation made in this thesis considered a relatively “low-level” aspect of processing. By changing the contrast polarity of the mask, ON and OFF pathways were activated selectively. Keeping the target contrast polarity constant, only the ON pathway was activated. As shown by the masking functions, both polarity conditions of the mask resulted in substantial amount of masking. This finding opposed those theories of masking that reject inhibitory mechanisms between ON and OFF pathways.

At the cortical level from which EEG signals were collected, segregation of such pathways are diminished due to cells responding both to luminance increments and decrements such as complex cells. However, differences in cortical activation patterns were found at a short SOA value, with ERP components showing correlations with visual awareness.

For a better understanding of masking phenomena, future empirical and theoretical work is required. Possible directions might be: changing the target polarity, that is conducting an experiment with a black target and black/white masks; changing the task to contrast matching to investigate the effect of contrast polarity on brightness judgements using similar target-mask pairs, such that it will be possible to compare the two tasks; re-designing the experiment for other imaging methods such as fMRI; using behavioral data for model testing and comparing the explanatory powers of the models of visual masking.

REFERENCES

- Agaoglu, S., Breitmeyer, B., & Ogmen, H. (2016). Metacontrast masking and attention do not interact. *Attention, Perception, & Psychophysics*, 78(5), 1363-1380.
- Albrecht, T., Klapötke, S., & Mattler, U. (2010). Individual differences in metacontrast masking are enhanced by perceptual learning. *Consciousness and cognition*, 19(2), 656-666.
- Albrecht, T., & Mattler, U. (2012). Individual differences in metacontrast masking regarding sensitivity and response bias. *Consciousness and cognition*, 21(3), 1222-1231.
- Andreassi, J. L., De Simone, J. J., & Mellers, B. W. (1976). Amplitude changes in the visual evoked cortical potential with backward masking. *Electroencephalography and Clinical Neurophysiology*, 41(4), 387-398.
- Andreassi, J. L. (1984). Interactions between target and masking stimuli: perceptual and event-related potential effects. *International Journal of Psychophysiology*, 1(2), 153-162.
- Bachmann, T. (2010). Individual differences in metacontrast: An impetus for clearly specified new research objectives in studying masking and perceptual awareness? *Consciousness and cognition*, 19(2), 667-671.
- Bachmann, T., & Francis, G. (2013). *Visual masking: Studying perception, attention, and consciousness*. Academic Press.
- Becker, M. W., & Anstis, S. (2004). Metacontrast masking is specific to luminance polarity. *Vision research*, 44(21), 2537-2543.

- Brainard, D. H. (1997) The Psychophysics Toolbox, *Spatial Vision* 10:433-436.
- Breitmeyer, B. G., & Ganz, L. (1976). Implications of sustained and transient channels for theories of visual pattern masking, saccadic suppression, and information processing. *Psychological review*, 83(1), 1.
- Breitmeyer, B. G. (1978). Metacontrast with black and white stimuli: Evidence for inhibition of on-and off-sustained activity by either on-or off-transient activity. *Vision Research*, 18(10), 1443-1448.
- Breitmeyer, B. G., & Ogmen, H. (2000). Recent models and findings in visual backward masking: A comparison, review, and update. *Perception & psychophysics*, 62(8), 1572-1595.
- Breitmeyer, B.G., & Ogmen, H. (2006). Visual Masking: Time slices through conscious and unconscious vision, (2nd Edition), Oxford, UK: Oxford University Press.
- Breitmeyer, B.G., Kafaligonul, H., Ogmen, H., Mardon, L., Todd S., & Ziegler, R. (2006). Meta- and paracontrast reveal differences between contour and brightness processing mechanisms, *Vision Research*, 46, 2645-2658.
- Breitmeyer, B. G., Tapia, E., Kafaligönül, H., & Ögmen, H. (2008). Metacontrast masking and stimulus contrast polarity. *Vision research*, 48(23-24), 2433-2438.
- Breitmeyer, B. G., & Tapia, E. (2011). Roles of contour and surface processing in microgenesis of object perception and visual consciousness. *Advances in cognitive psychology*.
- Bridgeman, B. (1988). Visual evoked potentials: concomitants of metacontrast in late components. *Attention, Perception, & Psychophysics*, 43(4), 401-403.
- Enns, J. T., & Di Lollo, V. (2000). What's new in visual masking? *Trends in cognitive sciences*, 4(9), 345-352.
- Fahrenfort, J. J., Scholte, H. S., & Lamme, V. A. (2007). Masking disrupts reentrant processing in human visual cortex. *Journal of cognitive neuroscience*, 19(9), 1488-1497.
- Felleman, D. J., & Van Essen, D. C. (1991). Distributed hierarchical processing in the primate cerebral cortex. *Cerebral Cortex (New York, N.Y.: 1991)*, 1(1), 1-47.

- Gondan, M., & Röder, B. (2006). A new method for detecting interactions between the senses in event-related potentials. *Brain research*, 1073, 389-397.
- Goodale, M. A., & Milner, A. D. (1992). Separate visual pathways for perception and action. *Trends in neurosciences*, 15(1), 20-25.
- Hartline, H. K. (1938). The response of single optic nerve fibers of the vertebrate eye to illumination of the retina. *American Journal of Physiology-Legacy Content*, 121(2), 400-415.
- Hautus, M. J. (1995). Corrections for extreme proportions and their biasing effects on estimated values of d' . *Behavior Research Methods, Instruments, & Computers*, 27(1), 46-51.
- Jeffreys, D. A., & Musselwhite, M. J. (1986). A visual evoked potential study of metacontrast masking. *Vision research*, 26(4), 631-642.
- Kafaligonul, H. (2014). Vision: A Systems Neuroscience Perspective. *The Journal of Neurobehavioral Sciences*, 1(2), 21-26.
- Kaya, U., Yildirim, F. Z., & Kafaligonul, H. (2017). The involvement of centralized and distributed processes in sub-second time interval adaptation: an ERP investigation of apparent motion. *European Journal of Neuroscience*, 46(8), 2325-2338.
- Kingdom, F. A., & Prins, N. (2010). *Psychophysics: A practical introduction*.
- Kleiner M, Brainard D, Pelli D, 2007, "What's new in Psychtoolbox-3?" Perception 36 ECVF Abstract Supplement.
- Koivisto, M., & Revonsuo, A. (2010). Event-related brain potential correlates of visual awareness. *Neuroscience & Biobehavioral Reviews*, 34(6), 922-934.
- Lamme, V. A., & Roelfsema, P. R. (2000). The distinct modes of vision offered by feedforward and recurrent processing. *Trends in neurosciences*, 23(11), 571-579.
- Livingstone, M., & Hubel, D. (1988). Segregation of form, color, movement, and depth: anatomy, physiology, and perception. *Science*, 240(4853), 740-749.

Lamy, D., Salti, M., & Bar-Haim, Y. (2009). Neural correlates of subjective awareness and unconscious processing: an ERP study. *Journal of cognitive neuroscience*, 21(7), 1435-1446.

Luck, S. J. (2014). *An introduction to the event-related potential technique*. MIT press.

Mathewson, K. E., Gratton, G., Fabiani, M., Beck, D. M., & Ro, T. (2009). To see or not to see: prestimulus α phase predicts visual awareness. *Journal of Neuroscience*, 29(9), 2725-2732.

McCulloch, W. S., & Pitts, W. (1943). A logical calculus of the ideas immanent in nervous activity. *The bulletin of mathematical biophysics*, 5(4), 115-133.

Merigan, W. H., & Maunsell, J. H. (1993). How parallel are the primate visual pathways? *Annual review of neuroscience*, 16(1), 369-402.

Milner, D., & Goodale, M. (2006). *The visual brain in action*. Oxford University Press.

Mishra, J., Martinez, A., & Hillyard, S. A. (2008). Cortical processes underlying sound-induced flash fusion. *Brain research*, 1242, 102-115.

Ogmen, H., Breitmeyer, B.G., & Melvin, R. (2003). The what and where in visual masking. *Vision Research*, 43, 1337-1350.

Ögmen, H. (1993). A neural theory of retino-cortical dynamics. *Neural networks*, 6(2), 245-273.

Palmer, S. E. (1999). *Vision science: Photons to phenomenology*. MIT press.

Pelli, D. G. (1997) The VideoToolbox software for visual psychophysics: Transforming numbers into movies, *Spatial Vision* 10:437-442.

Railo, H., Koivisto, M., & Revonsuo, A. (2011). Tracking the processes behind conscious perception: a review of event-related potential correlates of visual consciousness. *Consciousness and cognition*, 20(3), 972-983.

Schiller, P. H., & Chorover, S. L. (1966). Metacontrast: Its relation to evoked potentials. *Science*, 153(3742), 1398-1400.

Schiller, P. H. (2010). Parallel information processing channels created in the retina. *Proceedings of the National Academy of Sciences*, 201011782.

Schiller, P. H. (2013). 5. *The Midget and Parasol systems* [video lecture]. Retrieved from: https://youtube.com/watch?v=_XTuXIXav78

Schmolesky, M. T., Wang, Y., Hanes, D. P., Thompson, K. G., Leutgeb, S., Schall, J. D., & Leventhal, A. G. (1998). Signal timing across the macaque visual system. *Journal of neurophysiology*, 79(6), 3272-3278.

Silverstein, D. N. (2015). A computational investigation of feedforward and feedback processing in metacontrast backward masking. *Frontiers in psychology*, 6, 6.

Thaler, L., Schütz, A. C., Goodale, M. A., & Gegenfurtner, K. R. (2013). What is the best fixation target? The effect of target shape on stability of fixational eye movements. *Vision Research*, 76, 31-42.

Turvey, M. T. (1973). On peripheral and central processes in vision: Inferences from an information-processing analysis of masking with patterned stimuli. *Psychological review*, 80(1), 1.

Ungerleider, L. G., Mishkin, M. (1982). Two cortical visual systems. In D. J. Ingle, M. A. Goodale, & R. J. W. Mansfield (Eds.), *Analysis of visual behavior* (pp. 549–586). Cambridge, MA: MIT Press.

Vaughan, H. G., & Silverstein, L. (1968). Metacontrast and evoked potentials: A reappraisal. *Science*, 160(3824), 207-208.

Werner, H. (1935). Studies on contour: I. Qualitative analyses. *The American Journal of Psychology*, 47(1), 40-64.

APPENDICES

APPENDIX A

In this section complementary EEG data analysis are provided.

A.1 Contrast Polarity Comparisons

EEG channels were separated into specific regions and t-test results are plotted in terms of different significance levels, quantified by p-values obtained from pointwise running two tailed t-tests. Results are provided both for target and mask presentation (TM) and difference waves ($[TM+NS]-[T+M]$).

Contrast Polarity Comparison at SOA =10

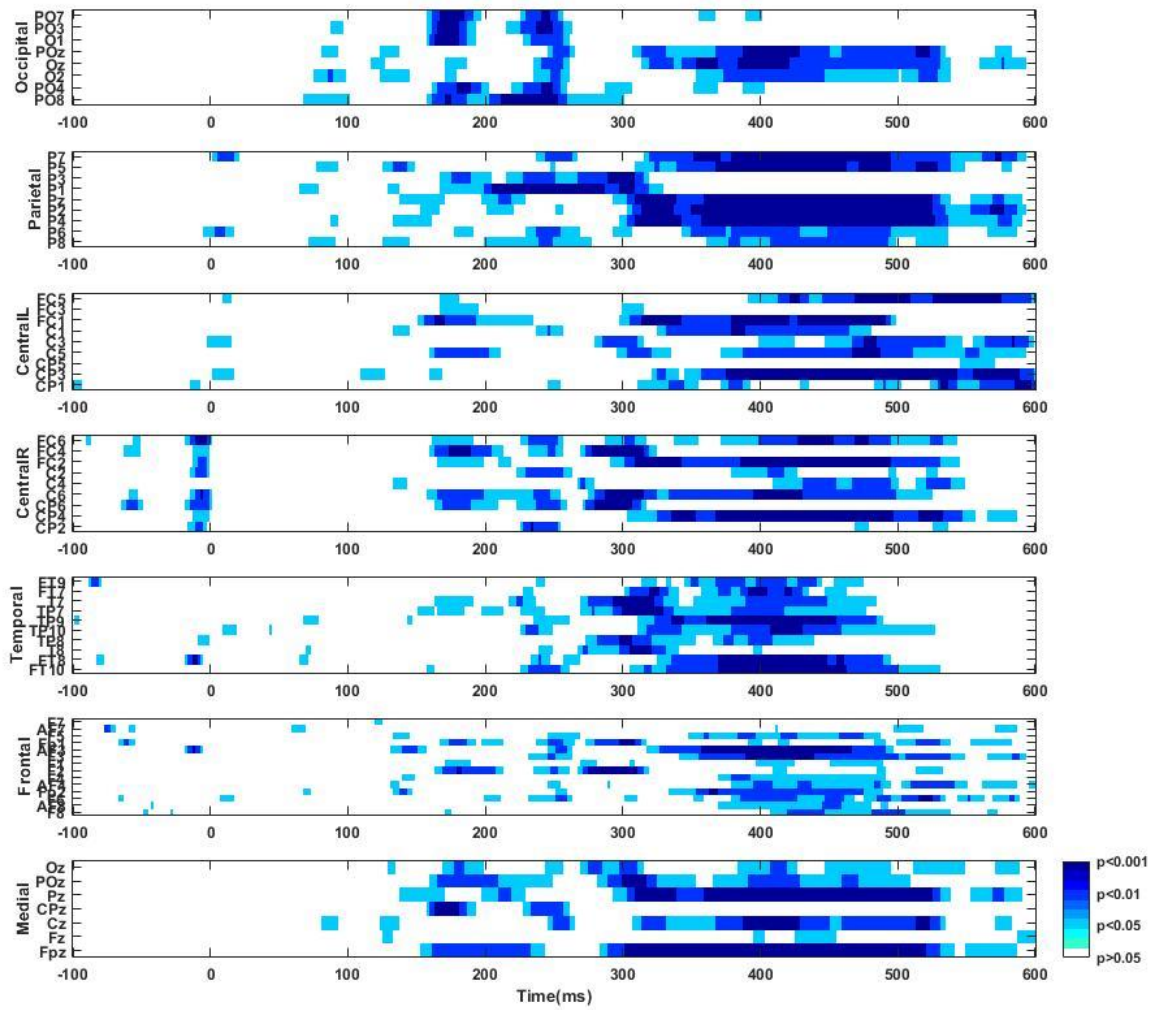

Figure A.1. T-test results for TM ERPs for different contrast polarity conditions at 10 ms of SOA.

Contrast Polarity Comparison at SOA = 10 ([TM+NS]-[T+M])

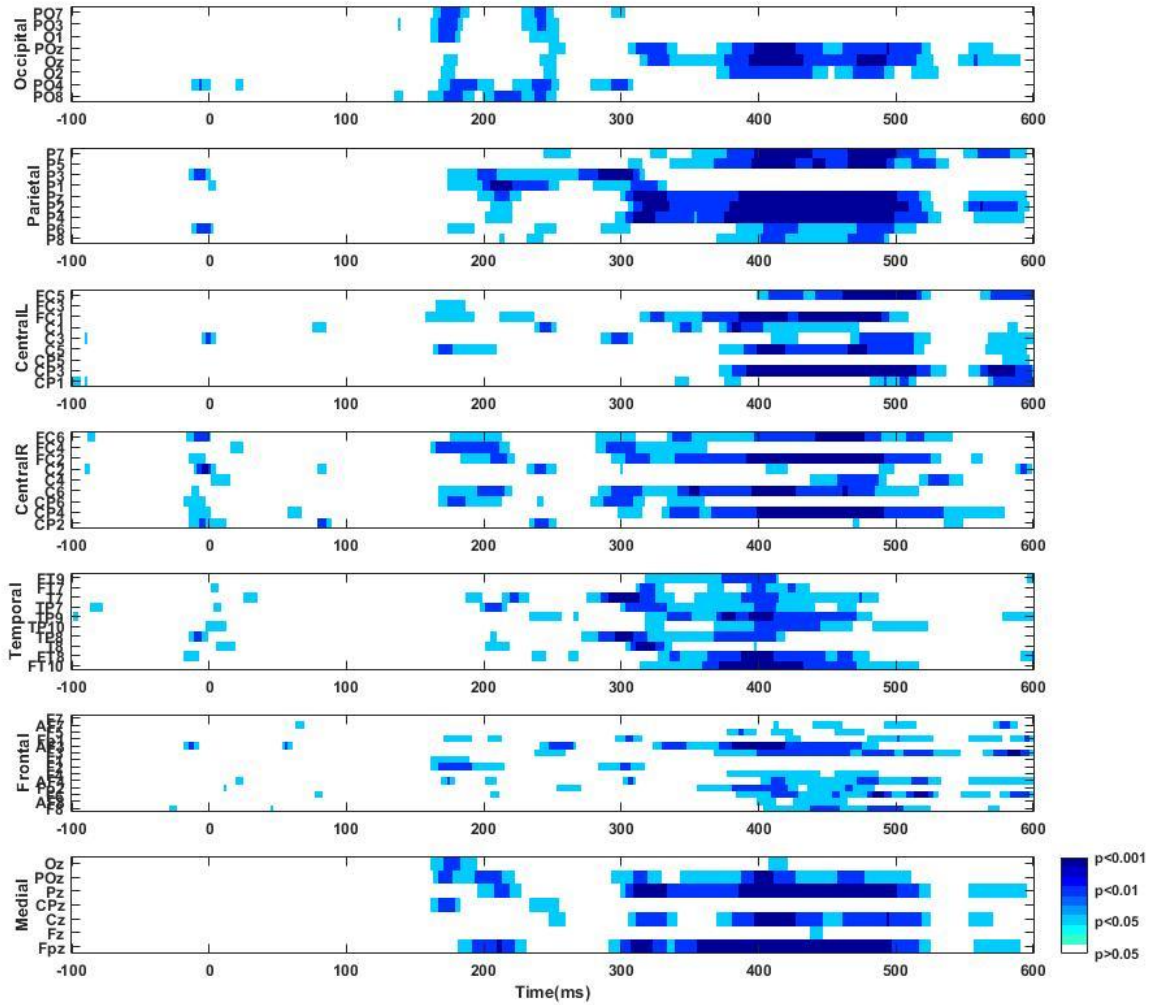

Figure A.2. T-test results for difference waves for different contrast polarity conditions at 10 ms of SOA.

Contrast Polarity Comparison at SOA =50

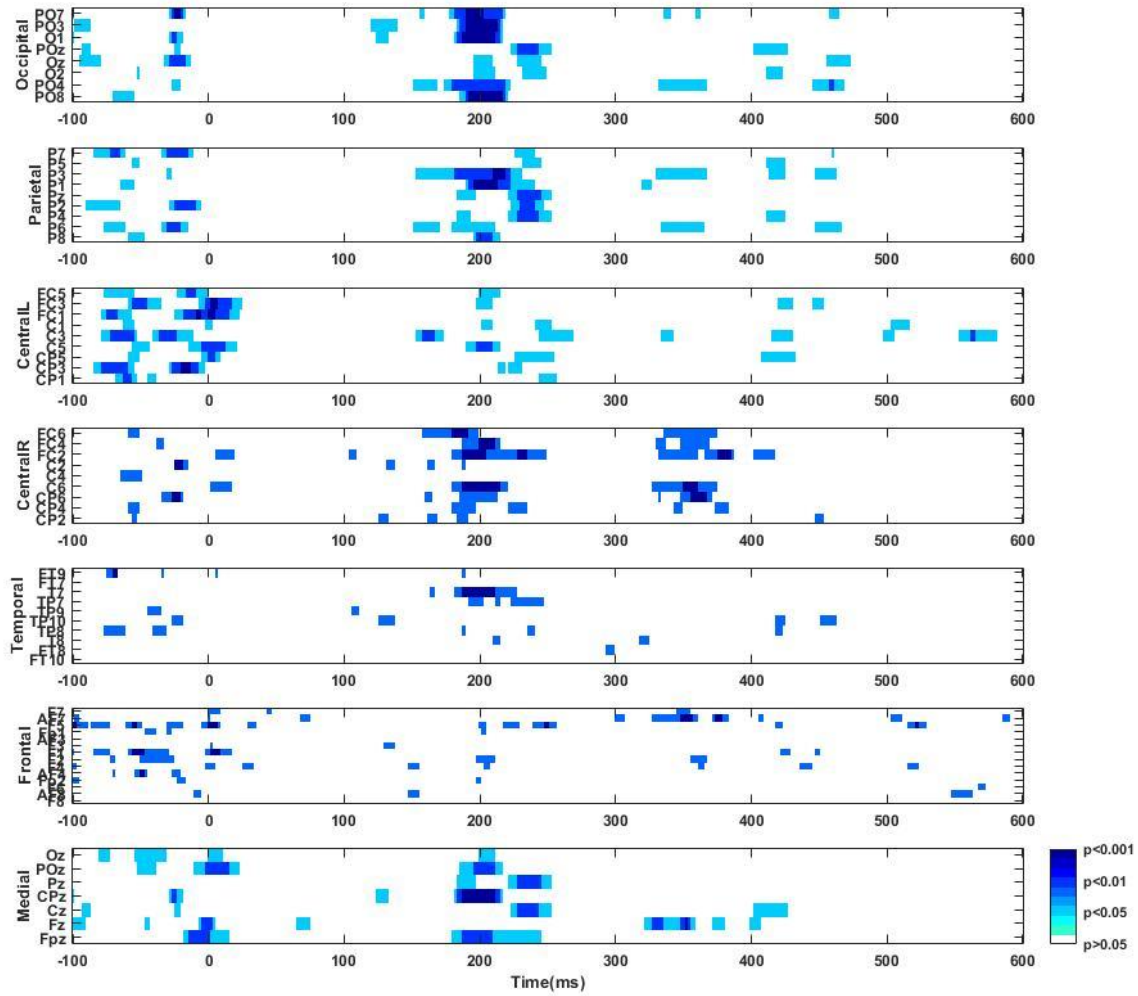

Figure A.3. T-test results for TM ERPs for different contrast polarity conditions at 50 ms of SOA.

Contrast Polarity Comparison at SOA =50 ([TM+NS]-[T+M])

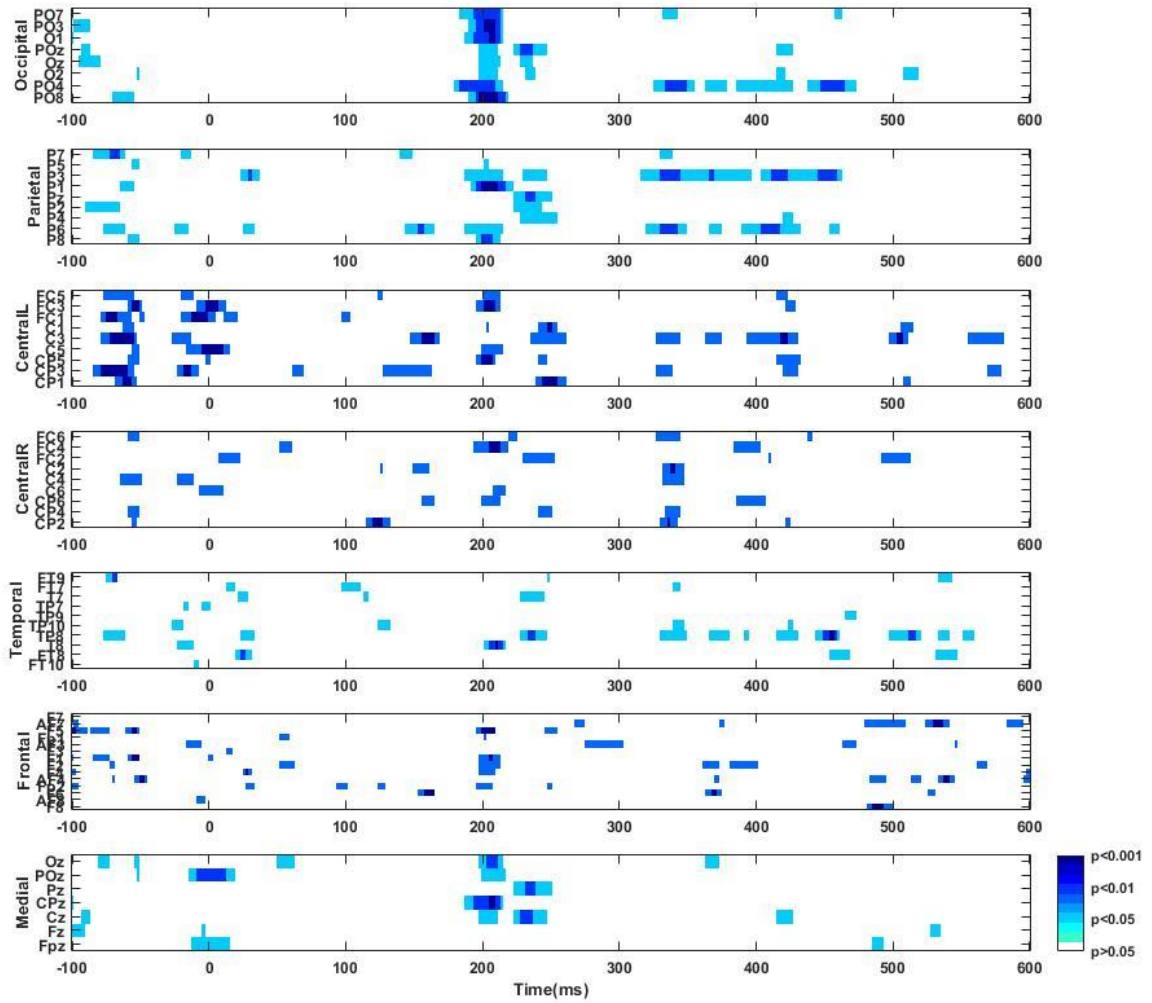

Figure A.4. T-test results for difference waves for different contrast polarity conditions at 50 ms of SOA.

Contrast Polarity Comparison at SOA =200

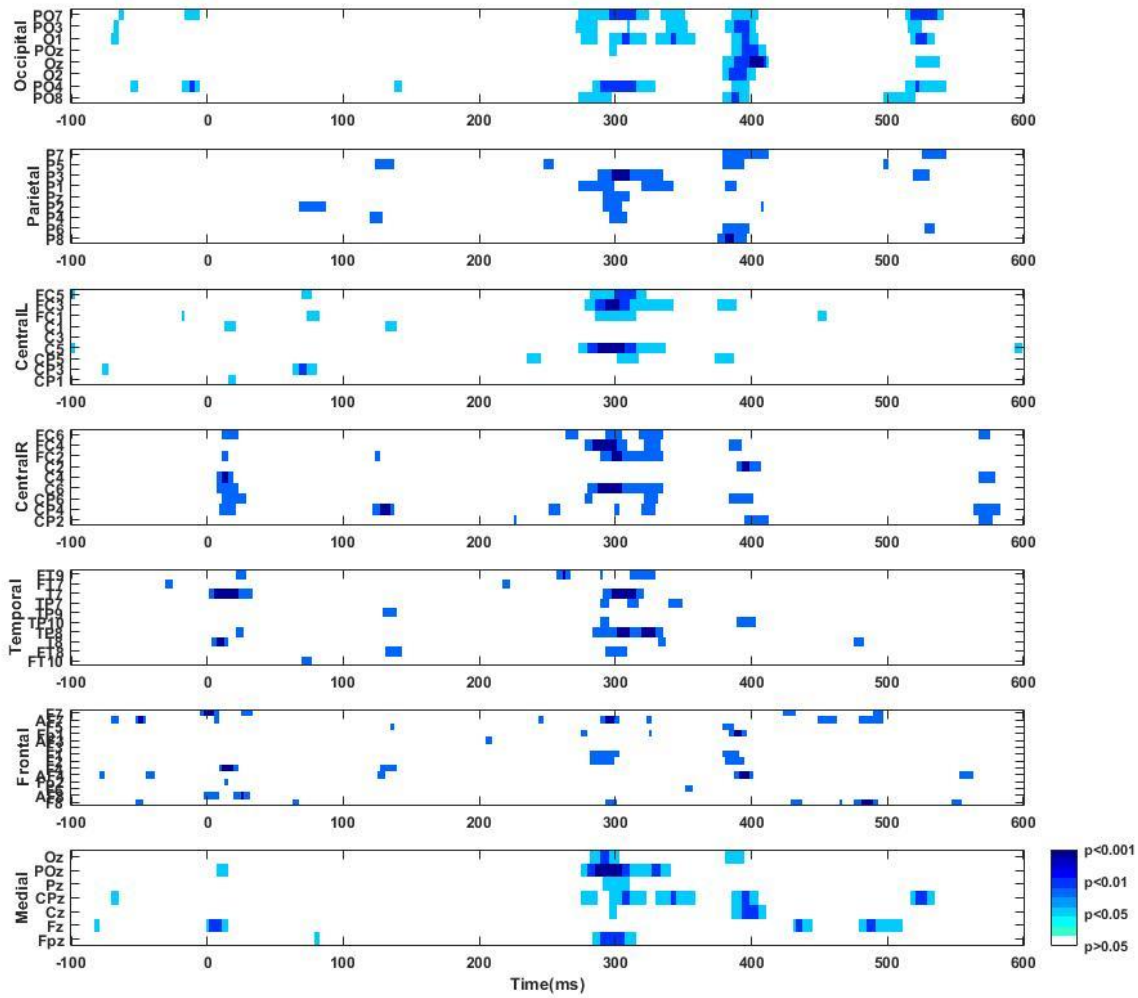

Figure A.5. T-test results for TM ERPs for different contrast polarity conditions at 200 ms of SOA.

Contrast Polarity Comparison at SOA =200 ([TM+NS]-[T+M])

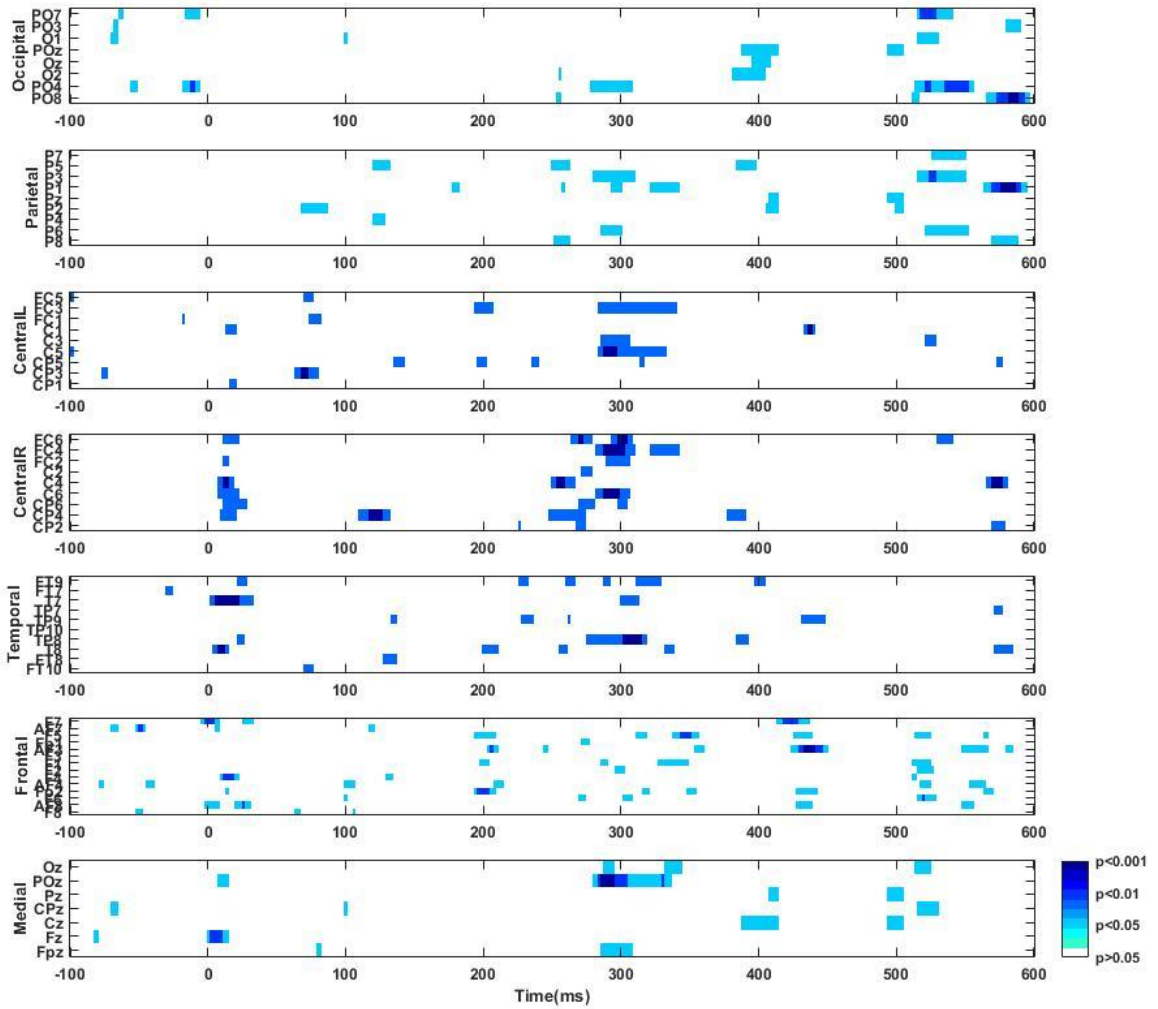

Figure A.6. T-test results for difference waves for different contrast polarity conditions at 200 ms of SOA.

A.2 SOA Comparisons Within Each Contrast Polarity Condition

EEG channels were separated into specific regions and t-test results are plotted in terms of different significance levels, quantified by p-values obtained from pointwise running two tailed t-tests. Results are provided for difference waves ([TM+NS]-[T+M]). Pairwise comparisons (10-50; 10-200; 50-200 ms) of different SOA conditions are provided within each polarity condition.

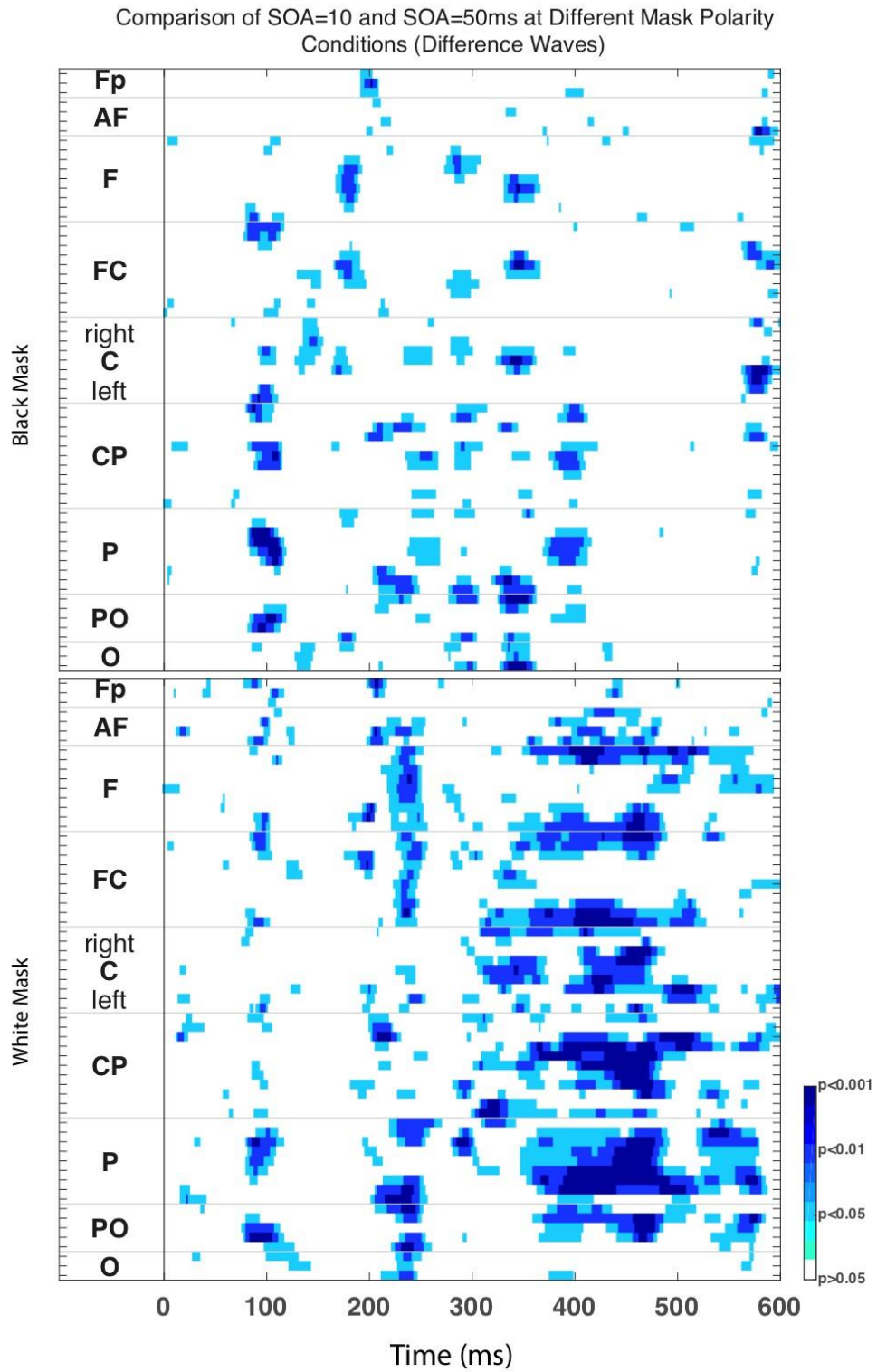

Figure A.7. T-test results for comparisons between SOA conditions of 10ms and 50ms.

Comparison of SOA=10 and SOA=200ms at Different Mask Polarity Conditions (Difference Waves)

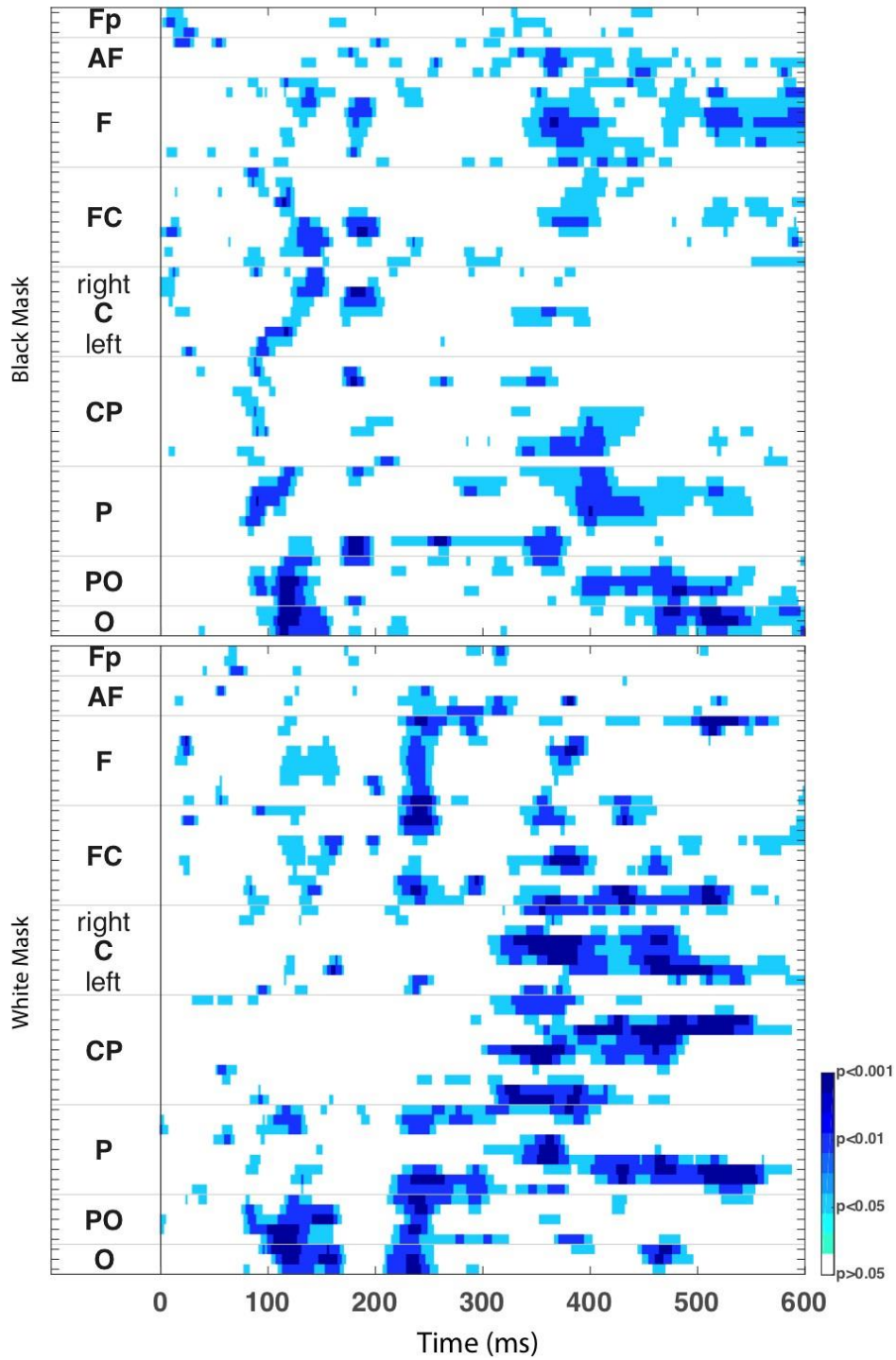

Figure A.8. T-test results for comparisons between SOA conditions of 10 ms and 200 ms.

Comparison of SOA=50 and SOA=200ms at Different Mask Polarity Conditions (Difference Waves)

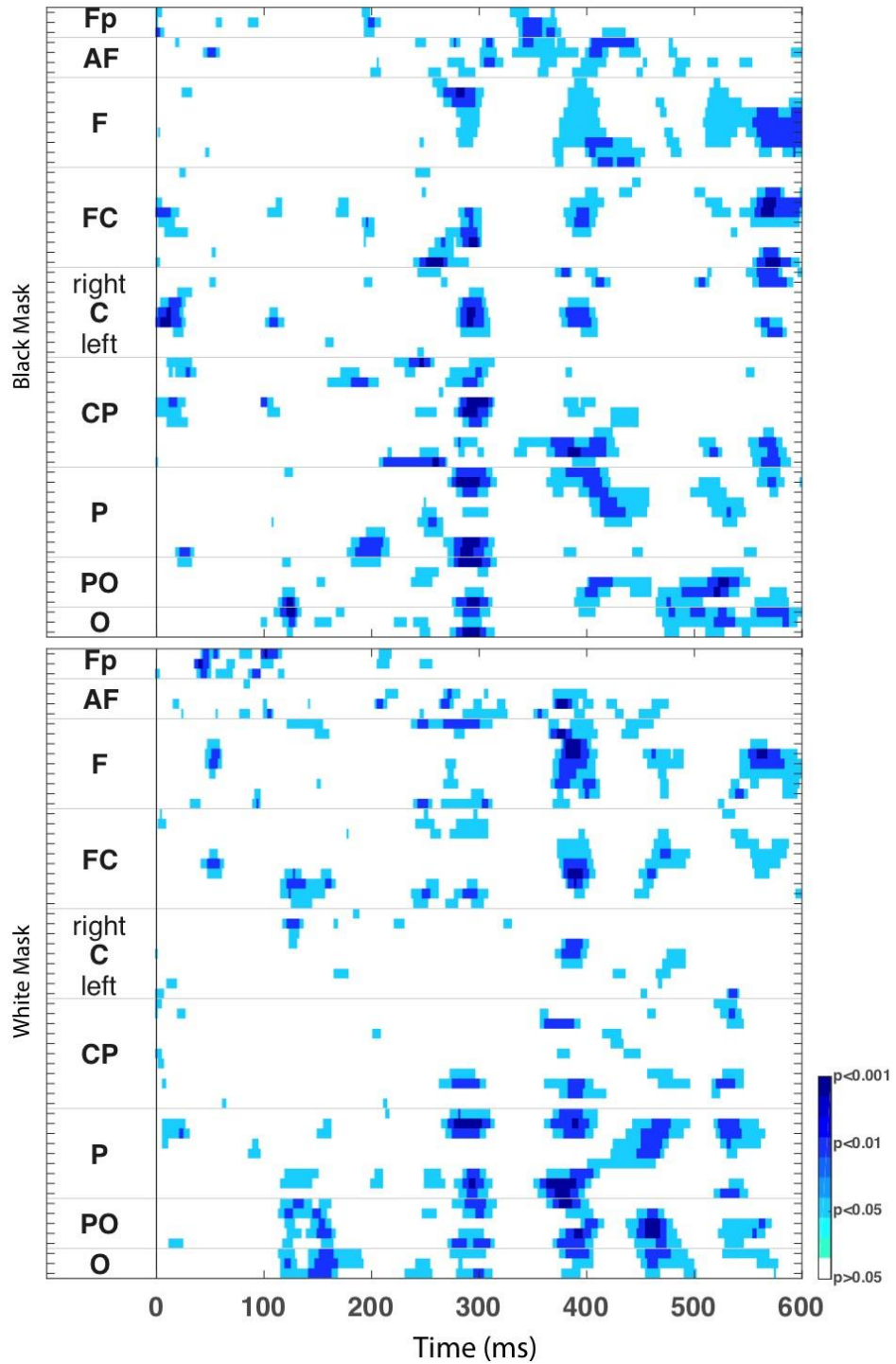

Figure A.9. T-test results for comparisons between SOA conditions of 50 ms and 200 ms.

A.3 Mask-Only Conditions

Comparison of Mask Only Trials for Black and White Masks

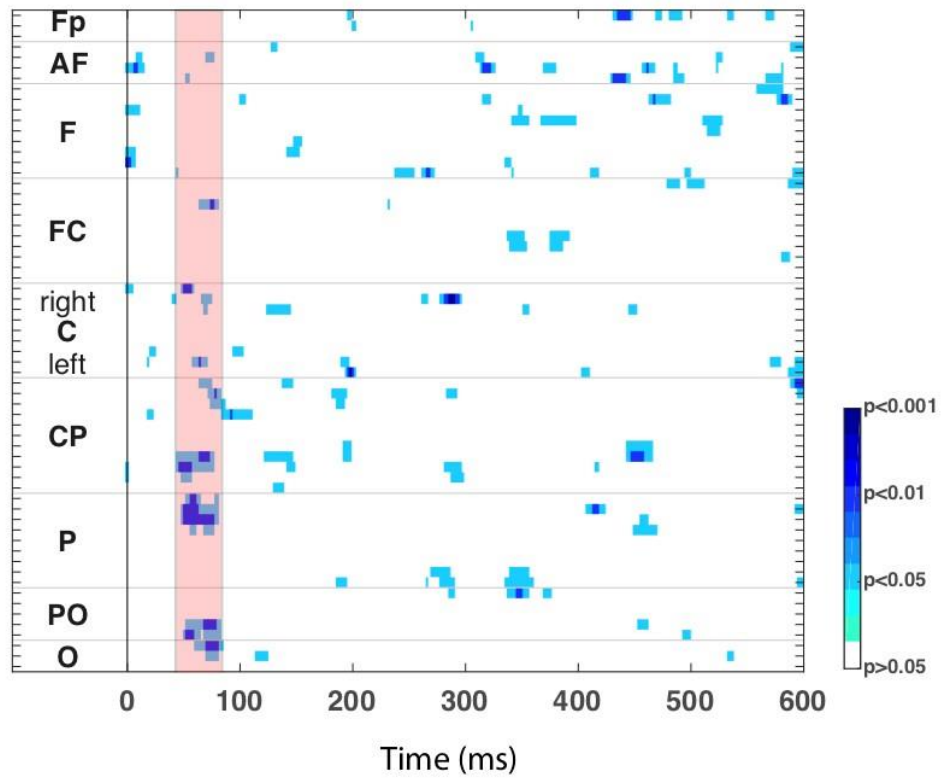

Figure A.10. Pointwise t-test results comparing white and black masks. [52,84] ms interval is selected for average scalp topographies.

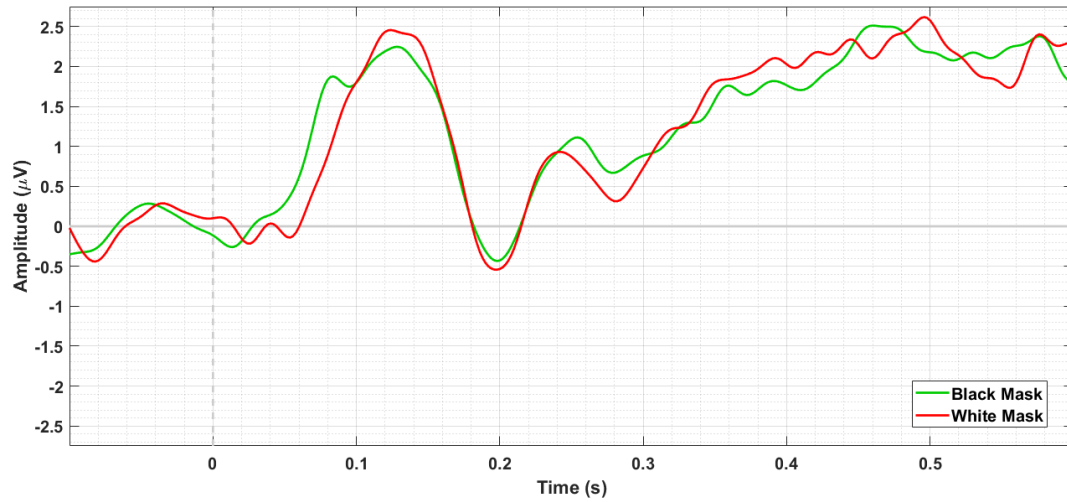
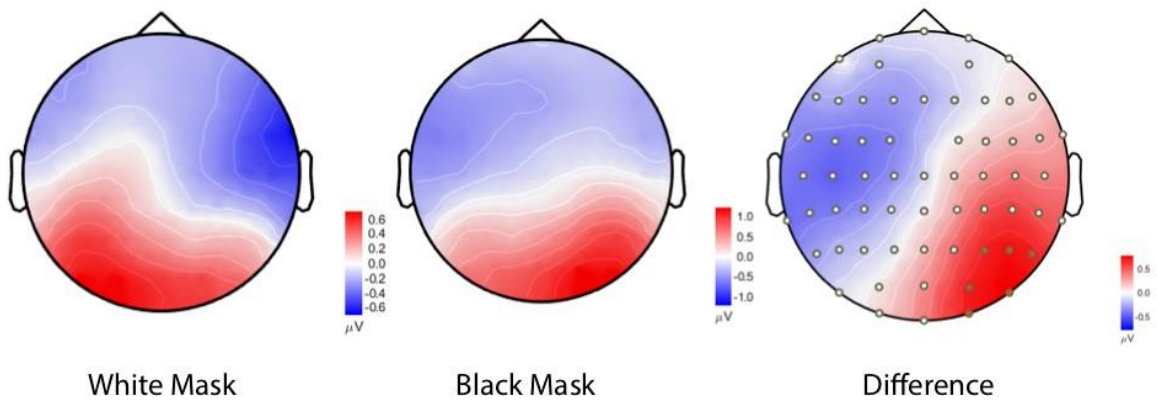

Figure A.11. Top: Scalp topographies of white and black mask-only conditions. Bottom: ERPs for different mask luminance values for mask-only conditions, average of O2, PO4, P4, P6, P8, PO8 electrodes.

A.4 Time Window Topographies

Three time windows were selected as I: [160-260] ms, II: [280-360] ms, and III: [380-500] ms and average activation topographies are plotted.

SOA = 10 ms

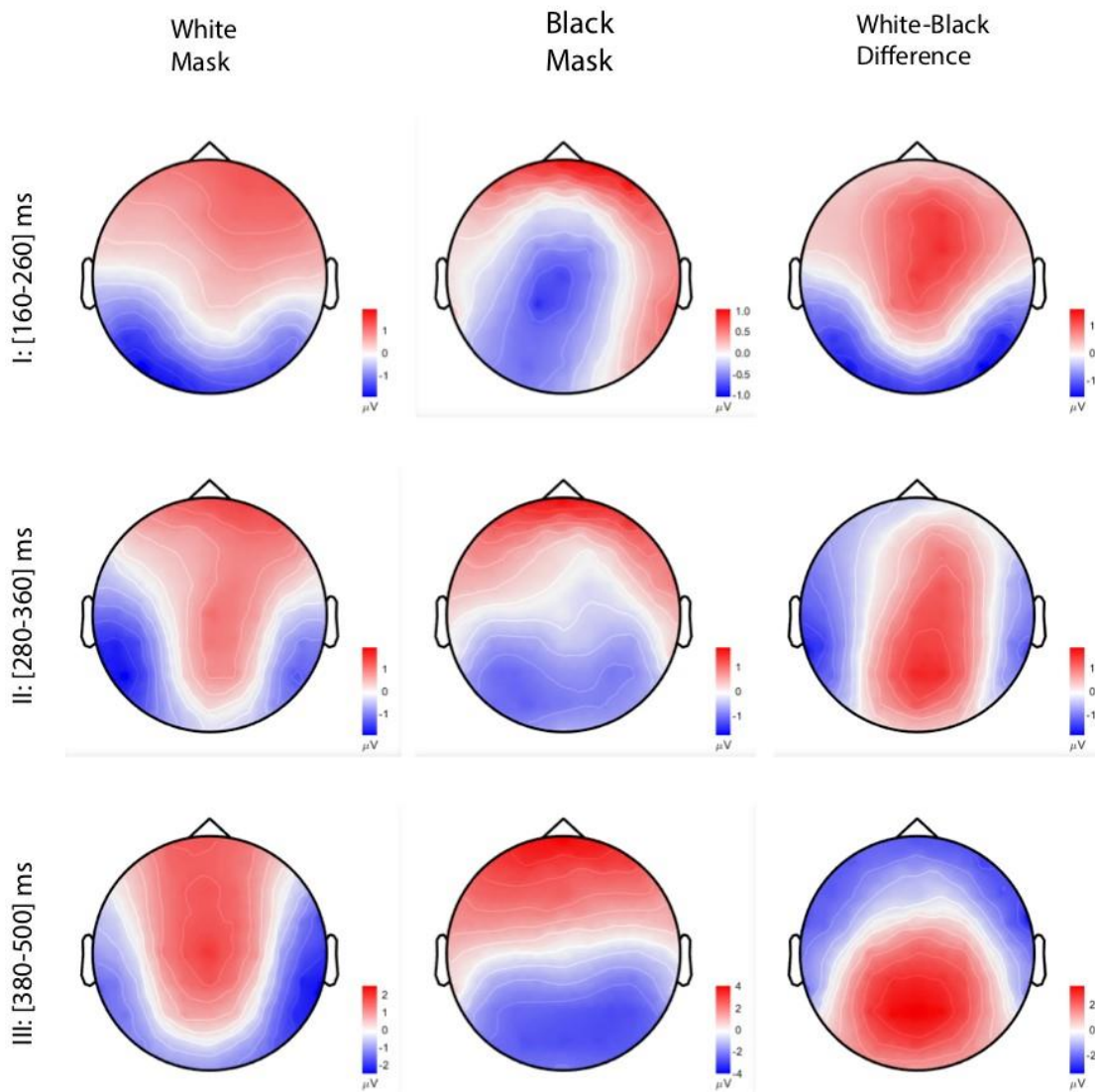

Figure A.12. Topographies at SOA = 10 ms.

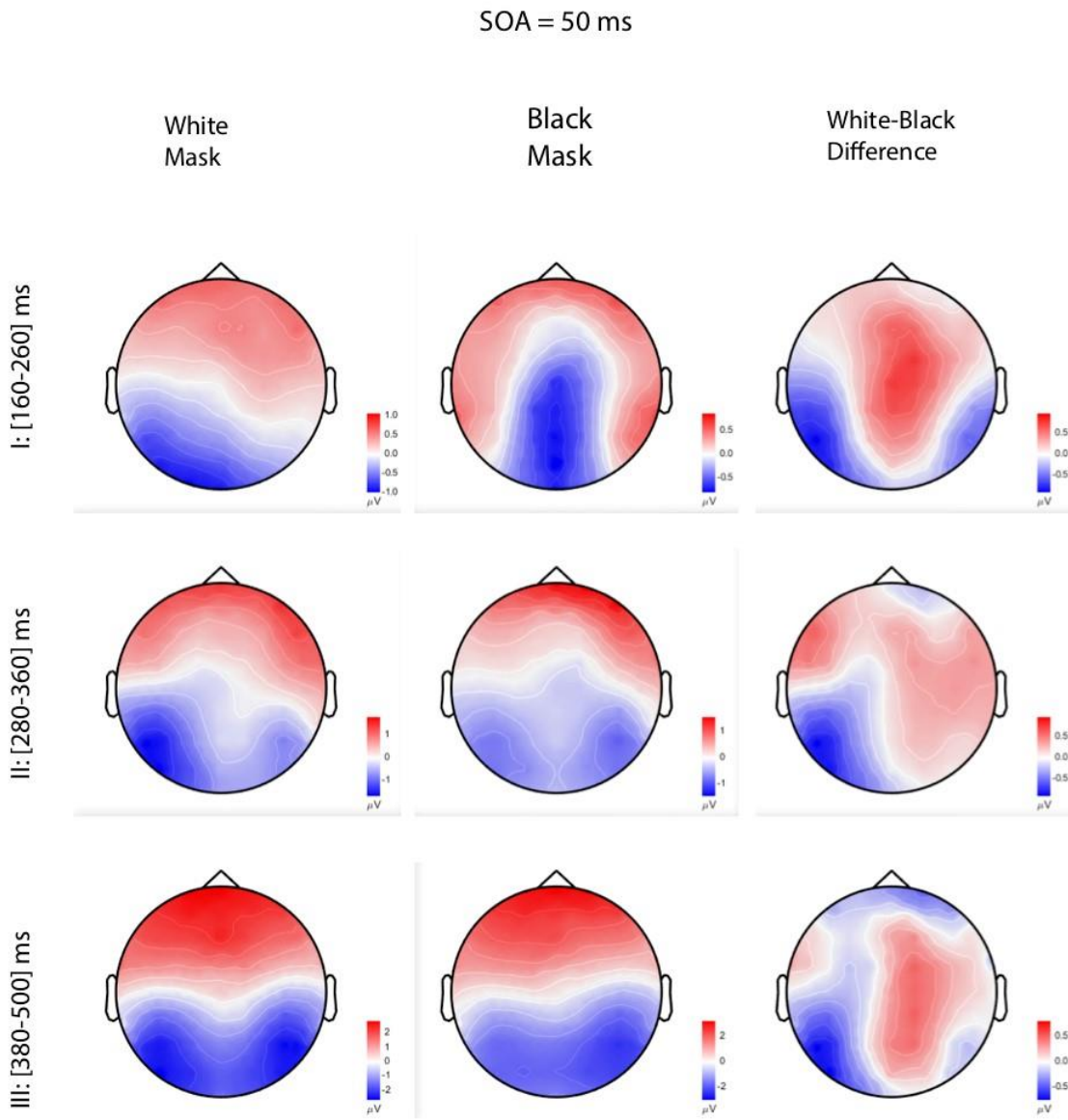

Figure A.13. Topographies at SOA = 50 ms.

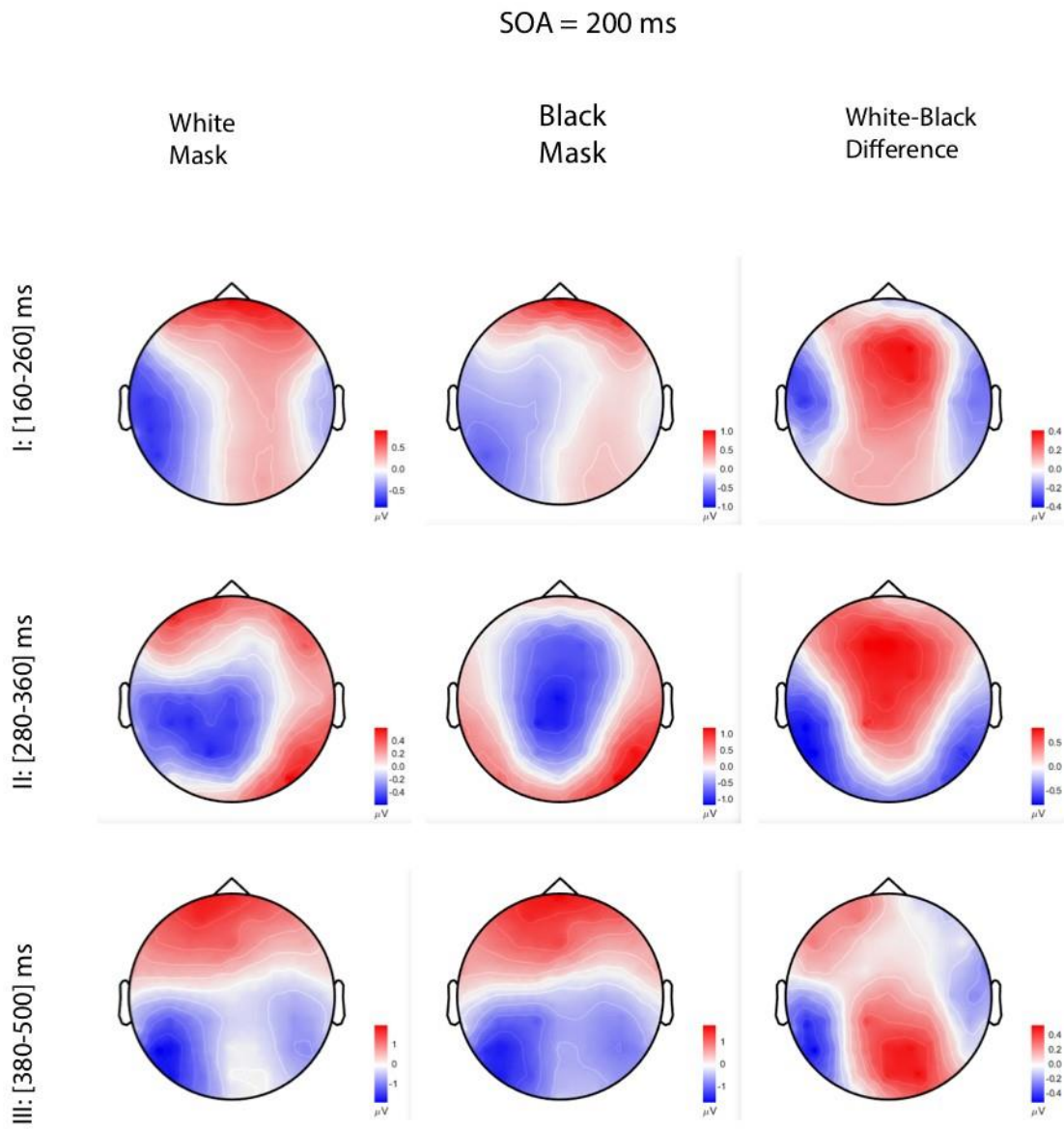

Figure A.14. Topographies at SOA = 200 ms.

APPENDIX B

In this section processing steps for a single subject are provided. EEG data was analyzed with Brainstorm (Tadel et al. 2011) toolbox, and in analyzing the data tutorials provided in Brainstorm website were followed.

B.1 Preprocessing Steps for a Single Subject

1. Remove large and unused segments. (e.g. session breaks, beginning and end)
2. Resample to 500 Hz: original recordings at 1000 Hz
3. Inspect power spectrum density: Using Welch method; 50% window overlap, 4 sec. window length, 0.25 Hz frequency resolution

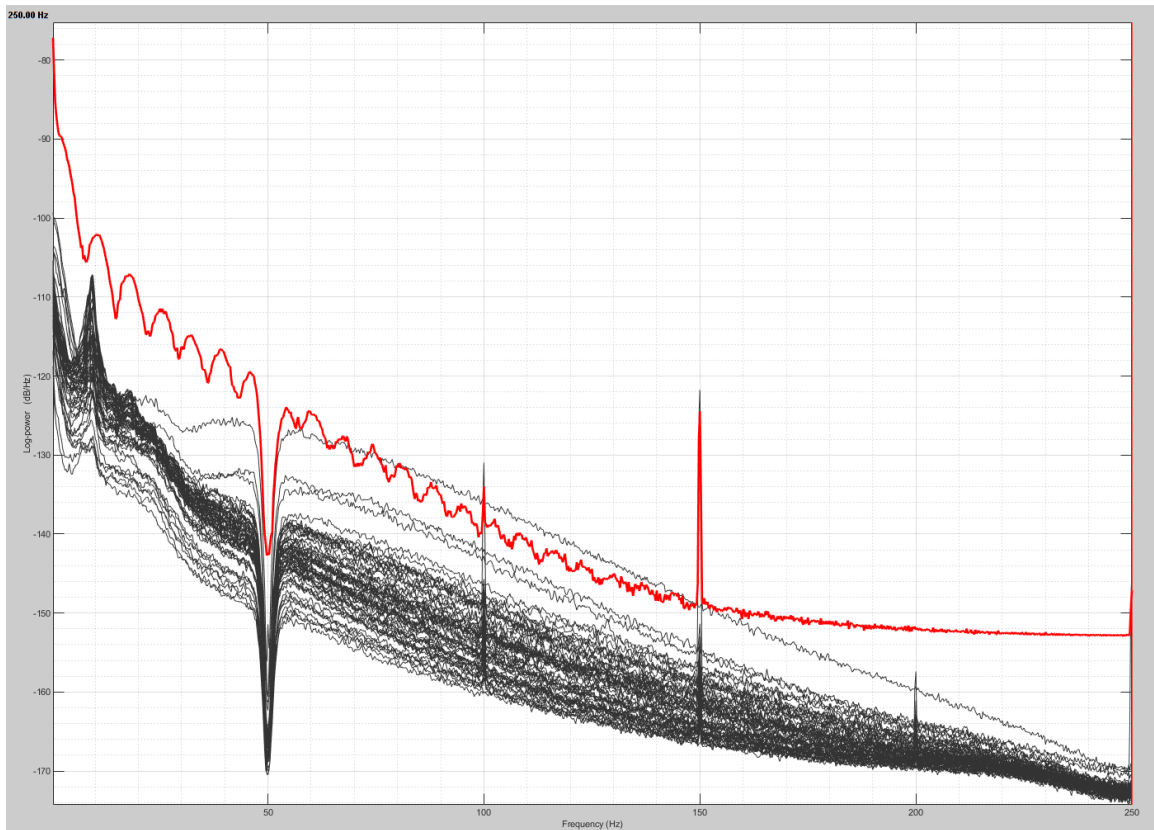

Figure B.1. Power spectrum density: Significantly noisy channel, marked with red

Power spectrum density gives information about:

- power line harmonics at 50, 100, 150, 200 Hz frequencies
- noisy channels (see figure B.3 and B.1)
- eye-movement/blink activity (see figure B.2)
- brain activity such as alpha waves at occipital lobe (see figure B.2)

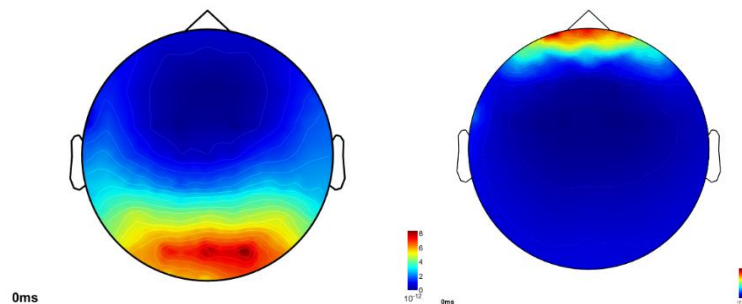

Figure B.2. Scalp topography. Left: Power distribution at 10Hz: alpha-band activity at occipital lobe. Right: Power distribution at 1.5Hz: frontal electrodes, eye movements.

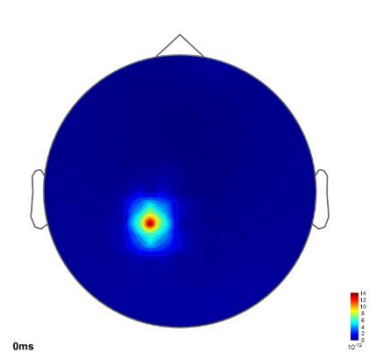

Figure B.3. Noisy channel (CP1) contaminating scalp topography.

4. Apply notch filter at 50 Hz harmonics
5. Band pass filter 0.5-70 Hz cutoff frequencies
6. Interpolate bad electrodes (using electrodes within 5.0 cm)
7. Re-reference to average
8. Detect artefacts
 - a. Cardiobalistic artefacts: using ECG electrode (e.g. 774 detected in 620 seconds = ~75bpm, normal)

- b. Blinks: using Fp1 & Fp2 electrodes, 74 detected in 620 seconds = ~7.2 blink/min (can be considered normal, regarding blink rate literature)
 - c. In artifact cleaning, consider the blink over a heartbeat. That is remove heartbeats if there is a blink at the same instance (within 250ms)
9. Correct blinks using ICA analysis.
 10. Manually inspect data for further noisy sections and non-detected artefacts, reject if present.
 11. Epoch data using event triggers. First use a large segment to see if epochs are contaminated by blinks. A window of [-600,1200] ms is used, where the origin is the event of interest.
 12. Mark epochs with artefacts such as blinks, saccades, movements inside the range as bad. (see figure B.4)
 13. It is possible to use raster plots of trials within selected electrodes to see artefacts. (see figure B.5)

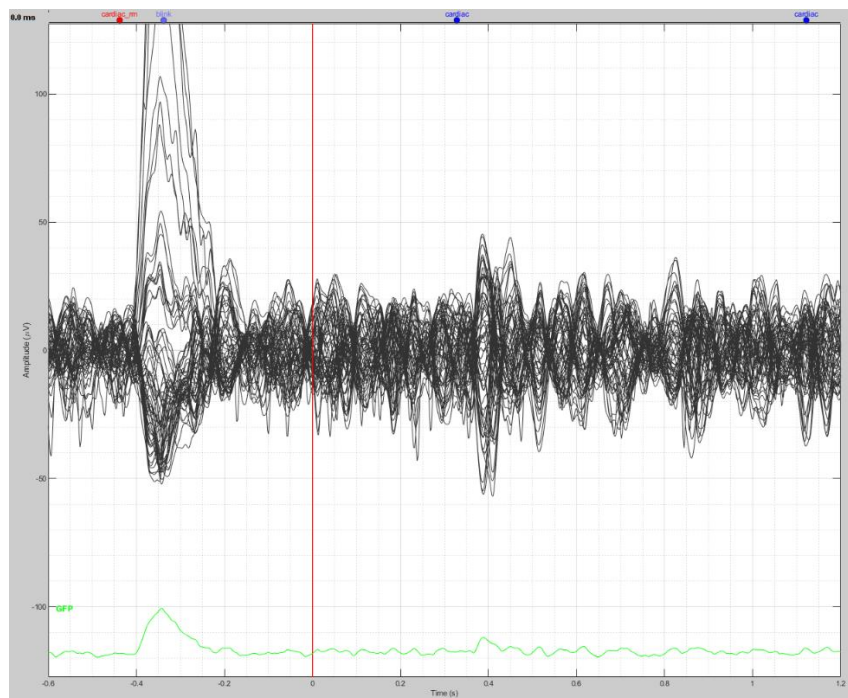

Figure B.4. A blink before stimulus onset may contaminate baseline activity, marked as bad trial.

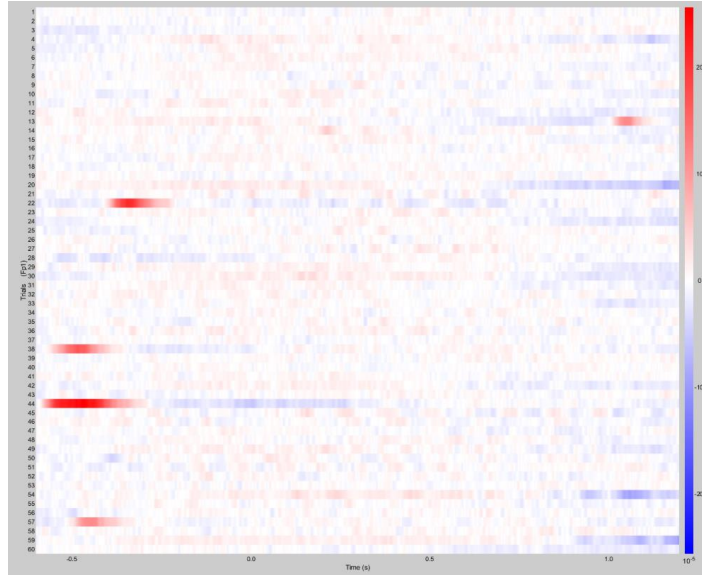

Figure B.5. Raster plot of electrode Fp1, for 60 trials for 'blank' condition. Dense red and blue portions where activity is significantly higher may indicate blinks.

14. Average trials within conditions to get ERPs.
15. Low pass filter at 40Hz for smooth visualization.
16. Subtract mean of baseline period [-100,0] ms from the whole epoch
17. Consider a smaller window: [-100,600] ms, regarding the region of interest
18. Cluster(average) electrodes for respective ERPs. (see figure B.6 for occipital cluster average ERPs for different conditions)

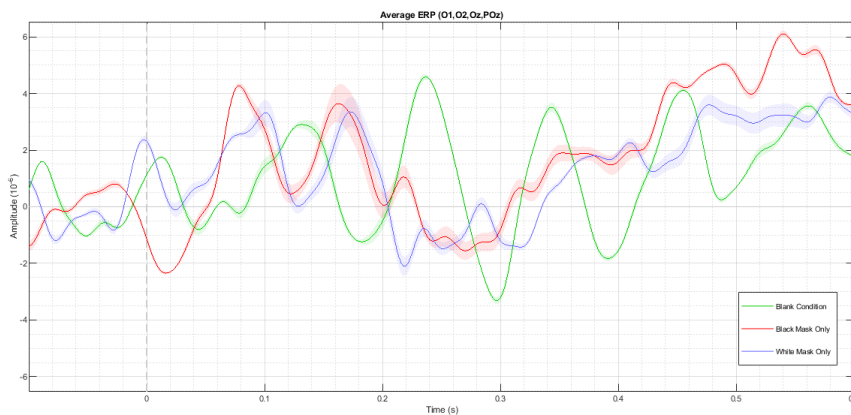

Figure B.6. ERPs for different conditions. Shades represent standard error.